

Art. Nr. 478198; 515564; 674863; 760762

LKZ 40605

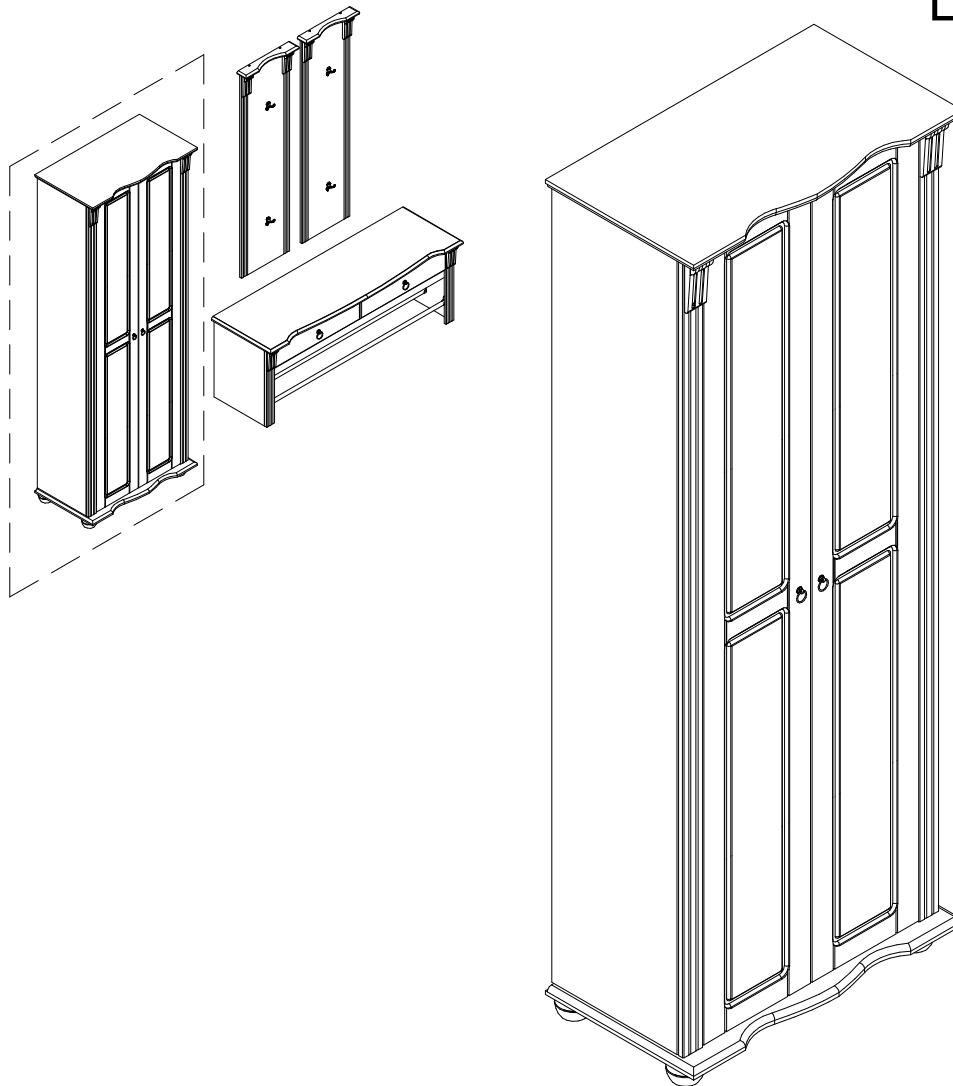

- | | | | |
|-----------|------------------------------------|-----------|--------------------------------|
| D | Montageanleitung | GB | Assembly instructions |
| FR | Notice de montage | IT | Istruzioni di montaggio |
| NL | Handleiding voor de montage | PL | Instrukcja montażu |
| CZ | Montážní návod | SK | Návod na montáž |
| HU | Szerelési útmutató | RO | Instrukțiuni de montaj |
| TR | Montaj talimatı | RU | Инструкция по монтажу |

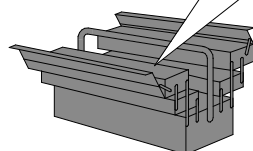
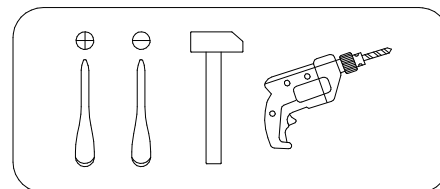
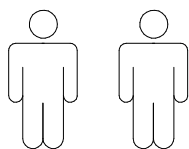

Service · Dienstverlening · Serwis · Servis · Сервисная служба







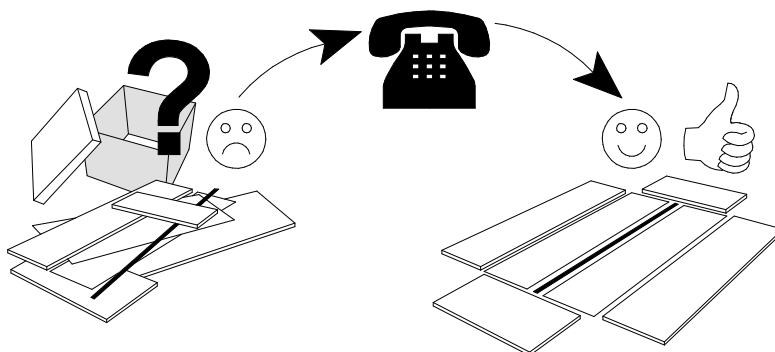
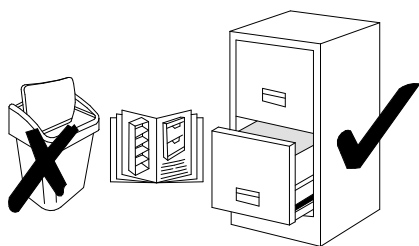



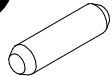

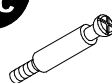
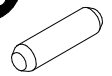

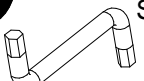

Name · Naam · Nazwa · Isim · Название

Nr. · No. · Номер

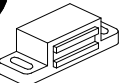
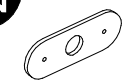
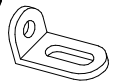
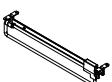
Typ · Type · Tip · Тип

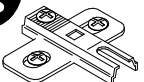

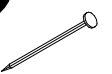
N	Size/MaB (mm)	Qty	✓	N	Size/MaB (mm)	Qty	✓
1	670×370	1		9	610×303	1	
2	670×370	1		10	1720×266	1	
3	1724×314	1		11	1720×266	1	
4	1724×314	1		12	76×50	8	
5	1724×50	1		13	200×40	6	
6	1724×50	1		14	60×φ80	4	
7	120×46	2		15	1742×628	1	
8	44×30	2		16	1715×30	1	

A	 8×30 ×20	B	 15×9.5 ×32	C	 7×24 ×32	D	 6×20 ×4	E	 7×50 ×4
F	 M4×16 ×2	G	 ×2	H	 SW4 ×1	I	 3.5×15 ×21	J	 3.5×20 ×4
K	 3.5×15 ×13	L	 4.0×45 ×16	M	 ×4	N	 ×4	O	 ×1
P	 ×1	Q	 ×1	R	 ×8	S	 ×8	T	 ×4
U	 ×50	V	 3.0×12 ×4	W	 3.5×25 ×16				

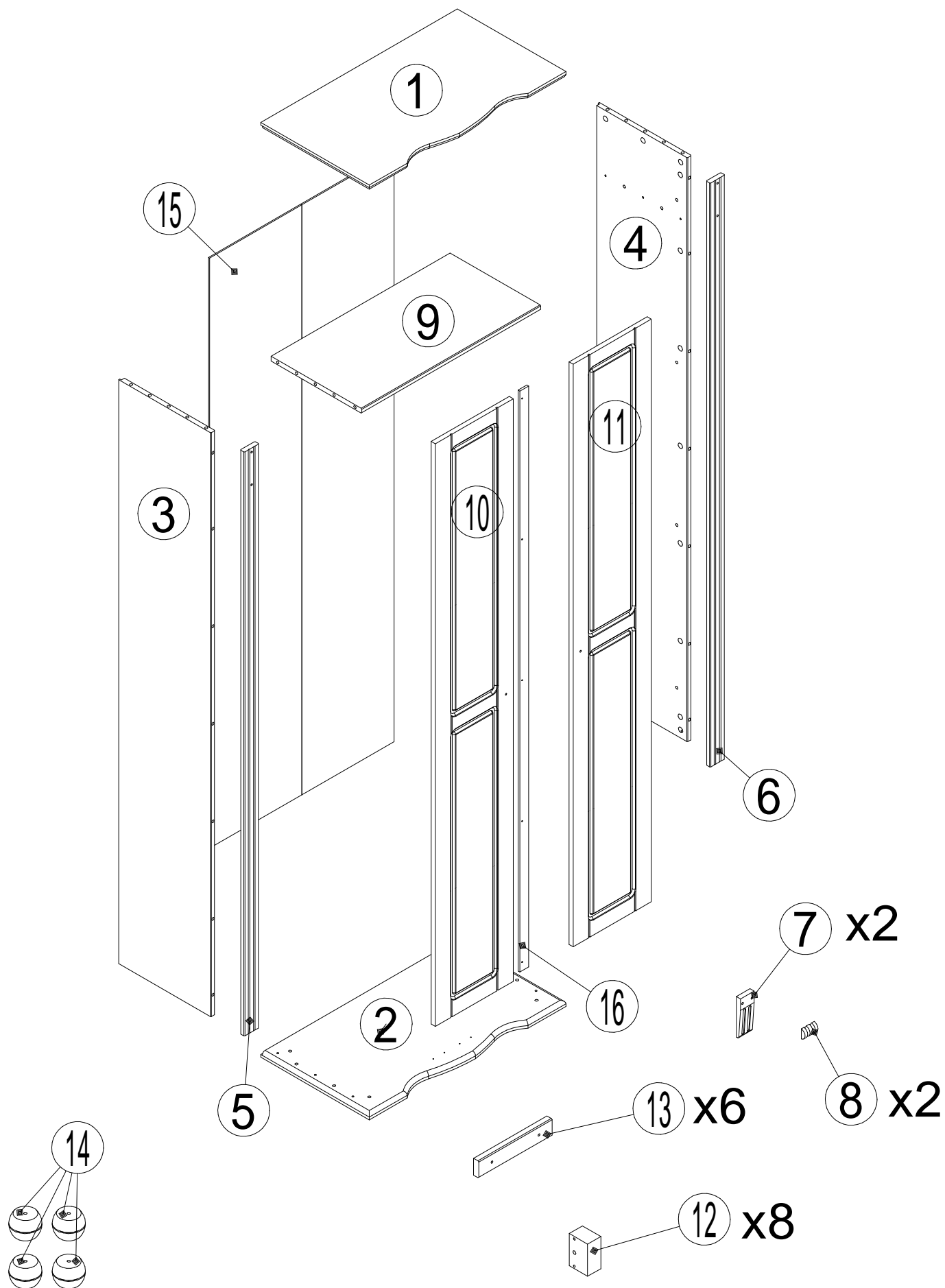

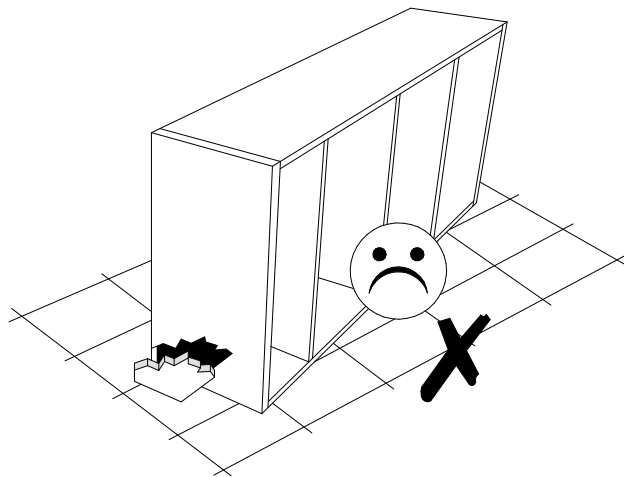
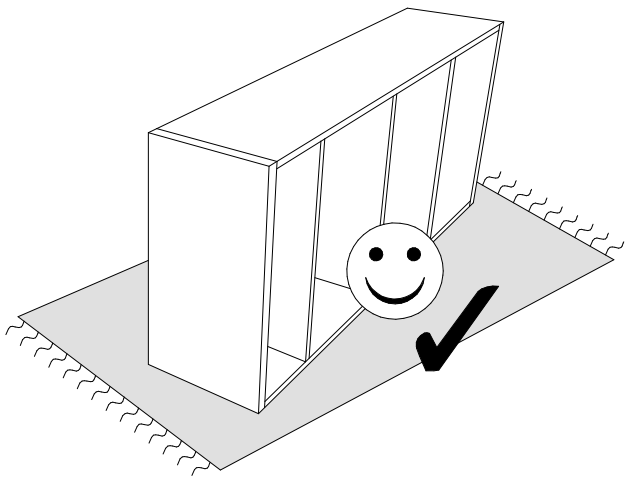

1

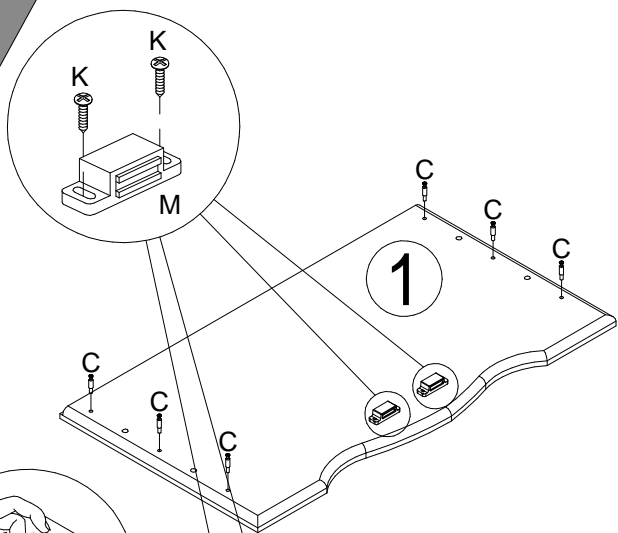

1

7

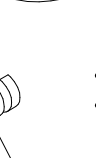
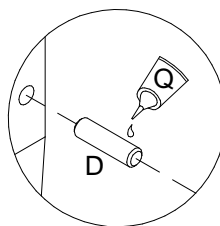

x2

8

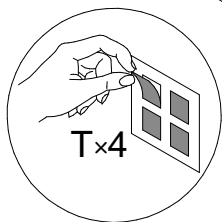

Tx4

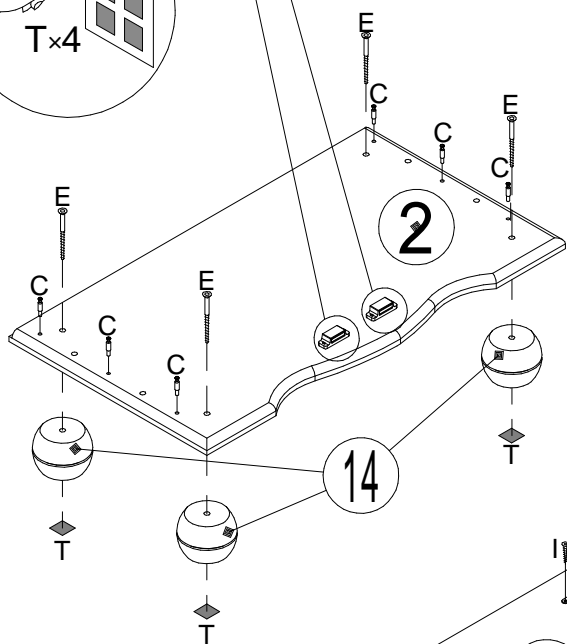

2

14

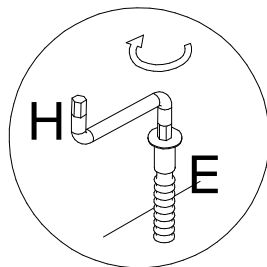

H

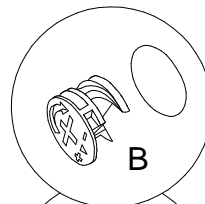

B

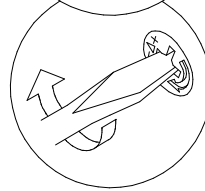

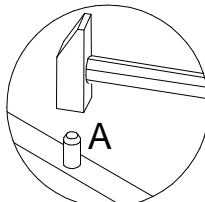
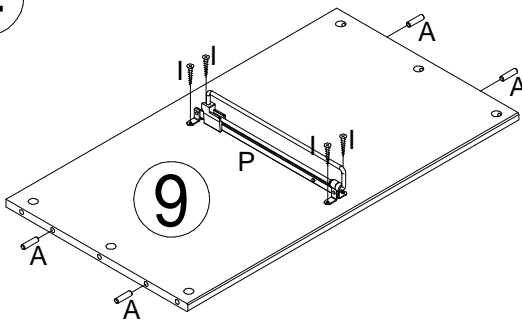

9

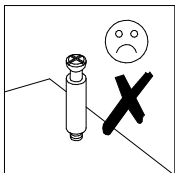
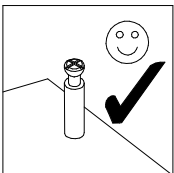
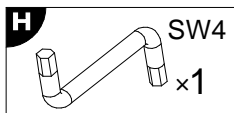
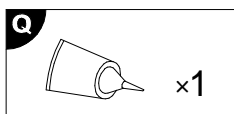
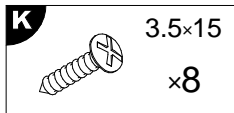
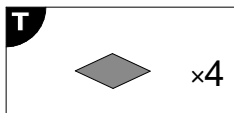
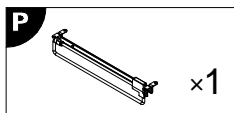
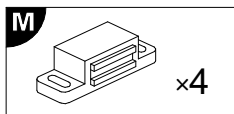
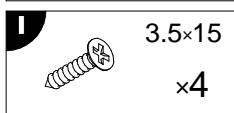
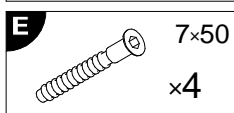
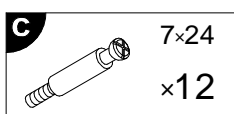
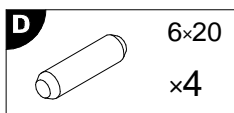
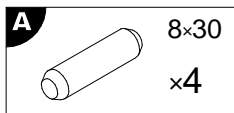

A

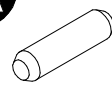
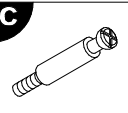
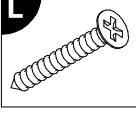

- A**  8x30
x16
- C**  7x24
x20
- L**  4.0x45
x16
- J**  3.5x20
x4

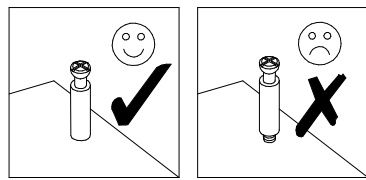
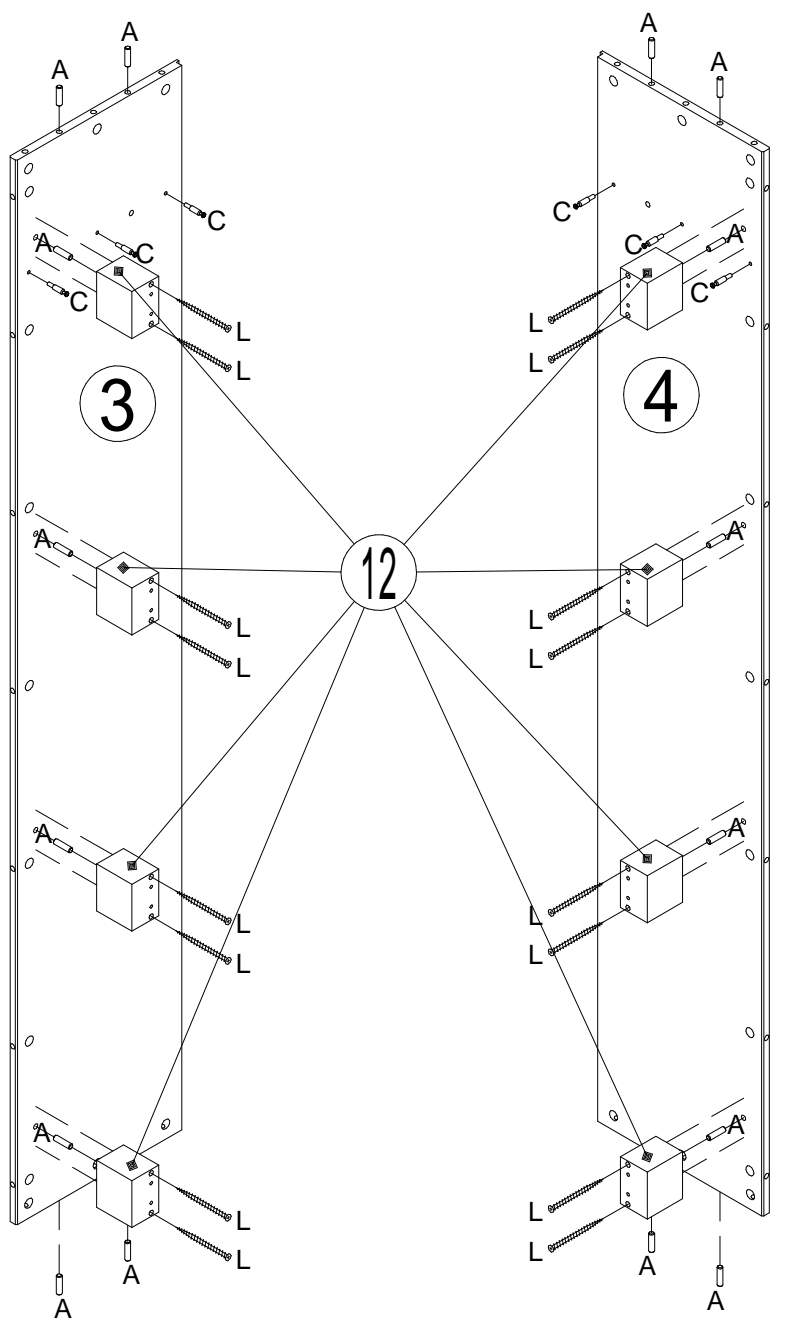
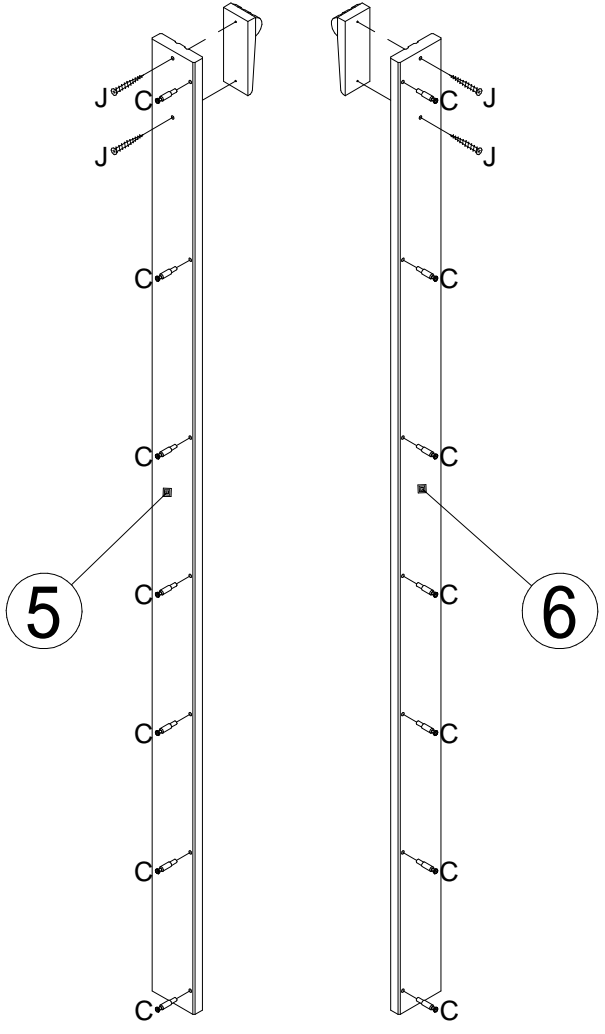
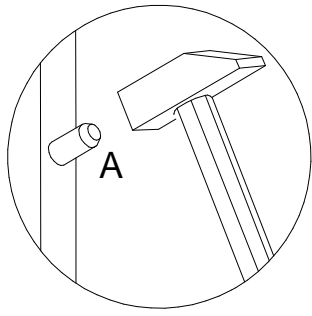

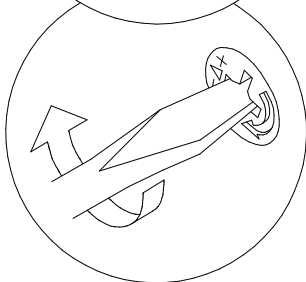
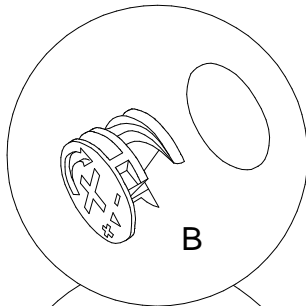
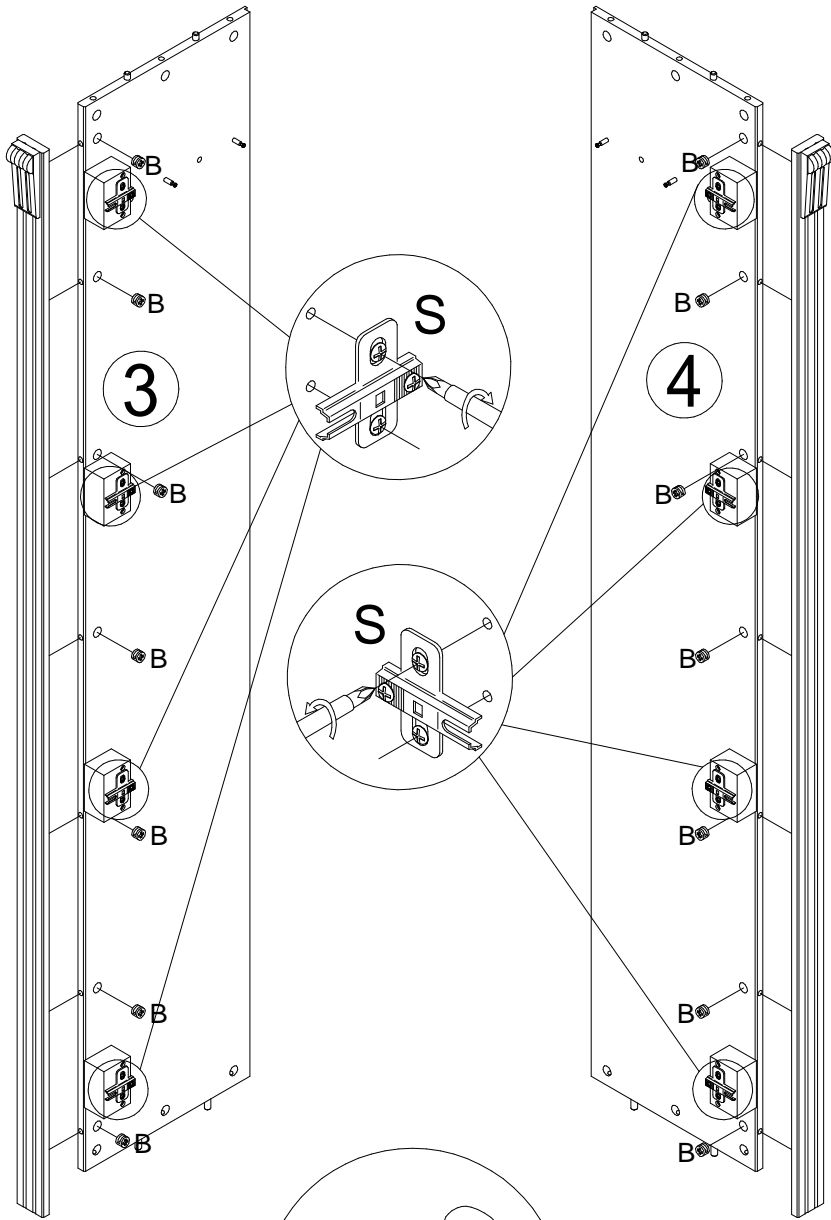
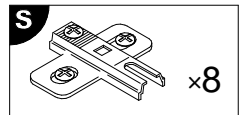
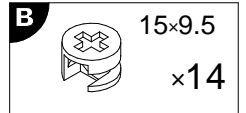

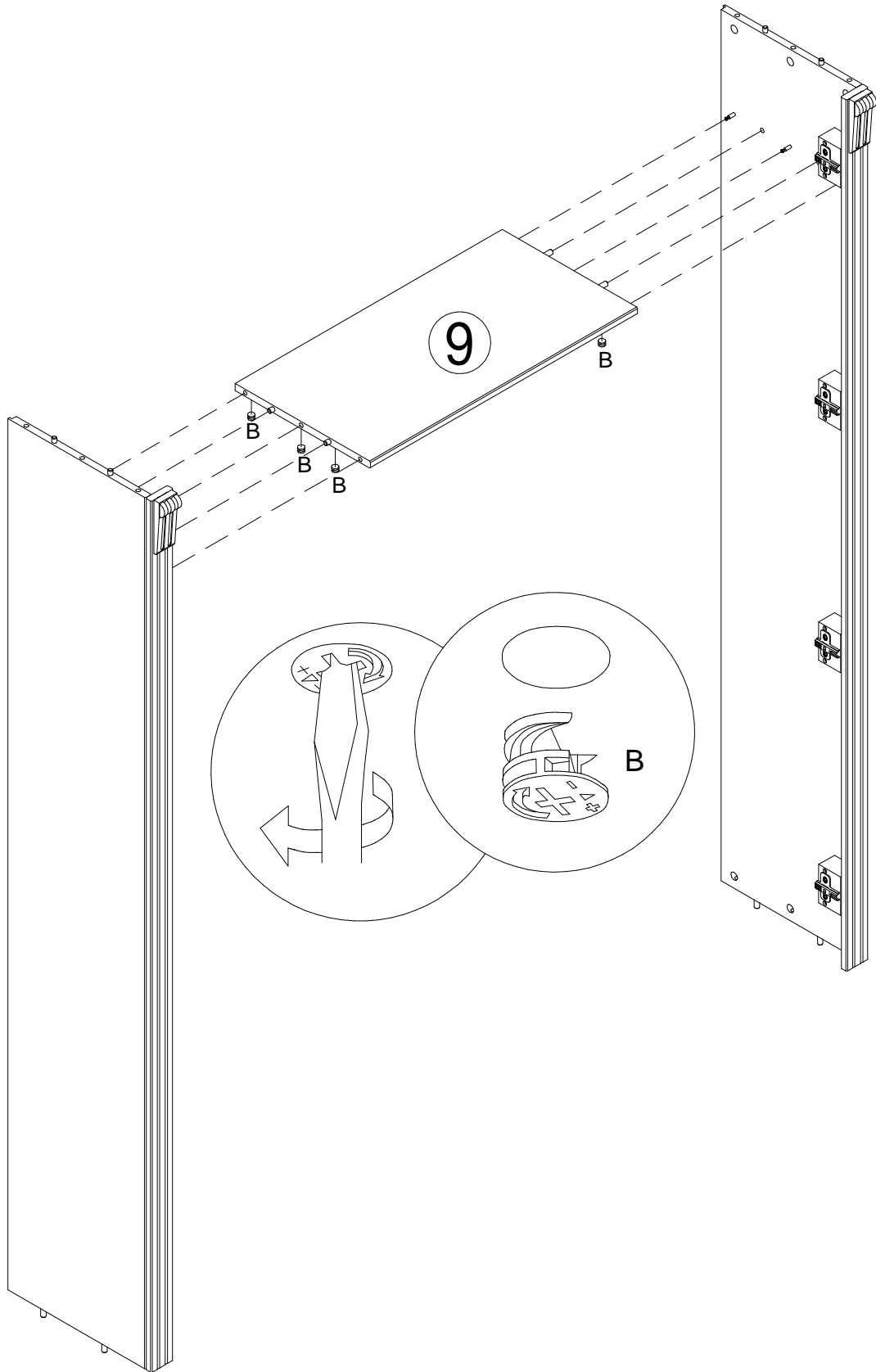
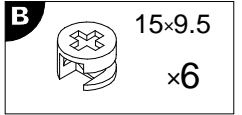

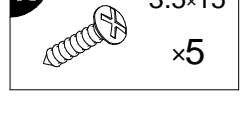
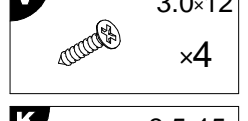
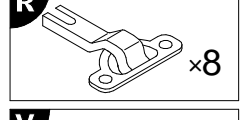
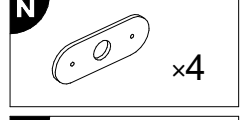
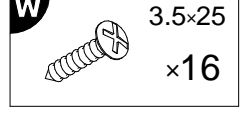
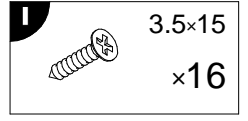
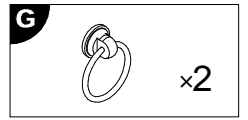
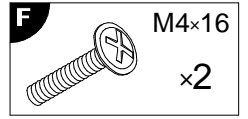
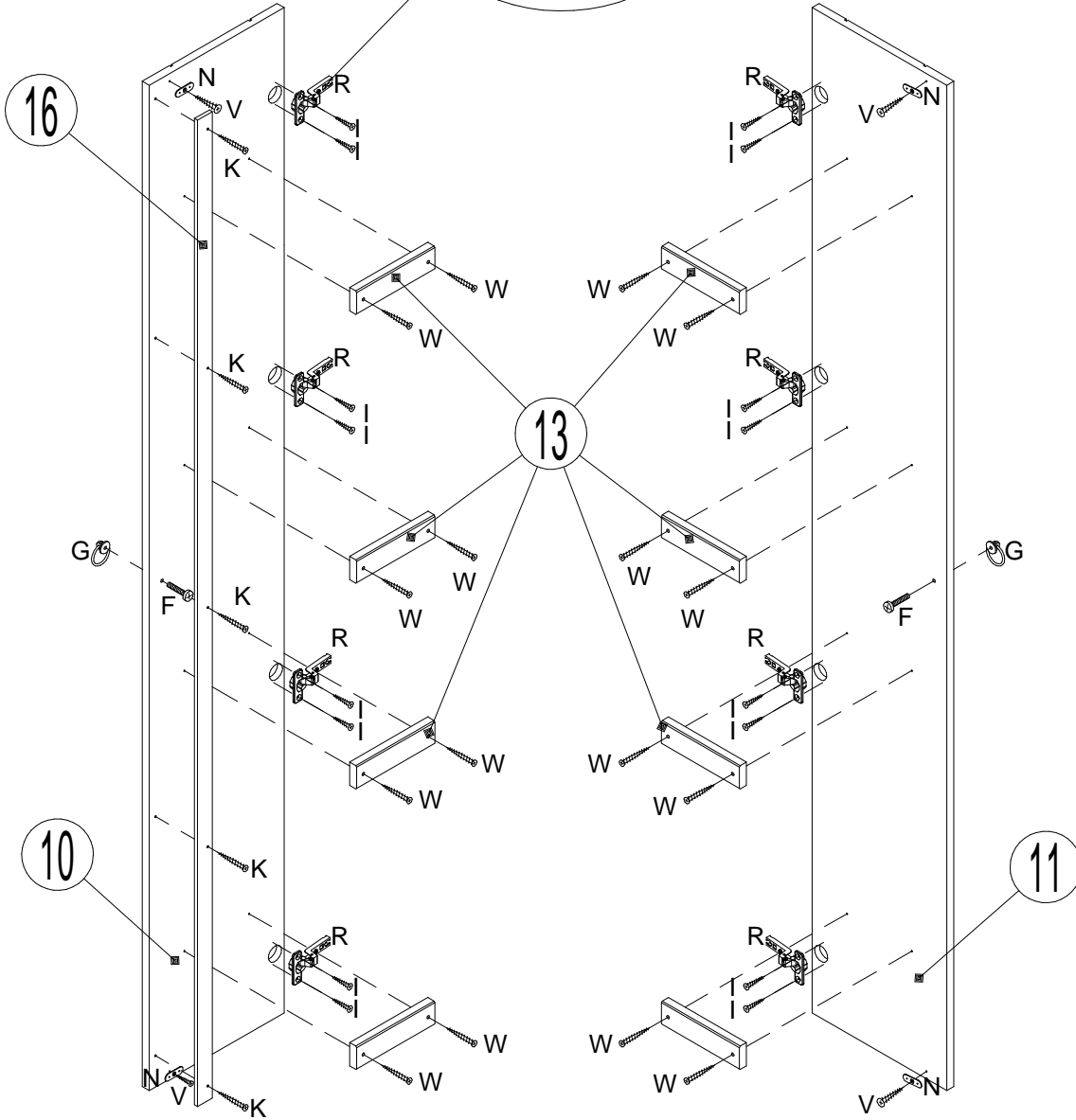
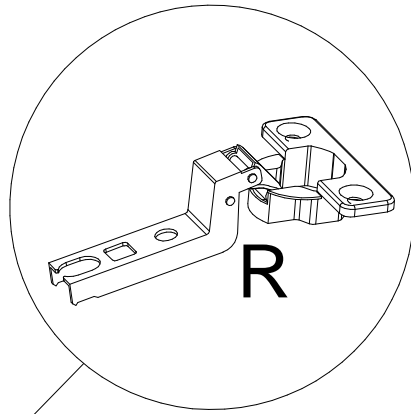

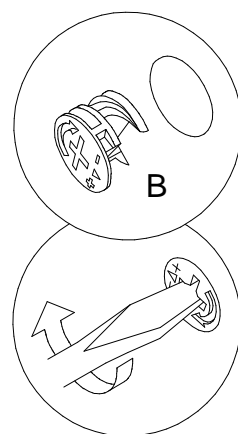
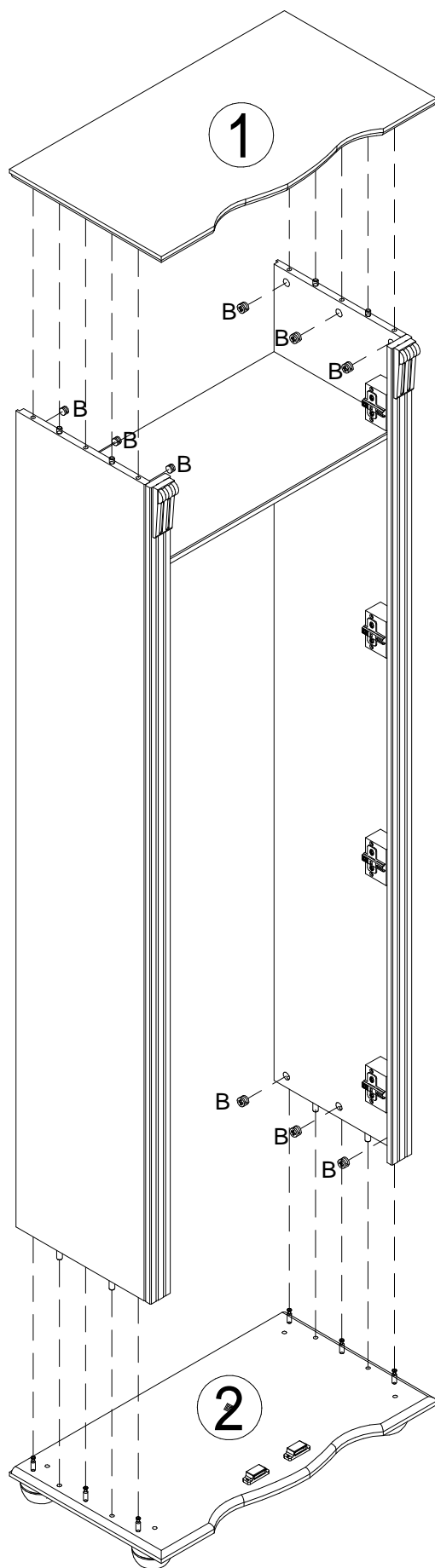

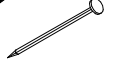

- I**  3.5x15
x1
- O**  x1
- U**  x50

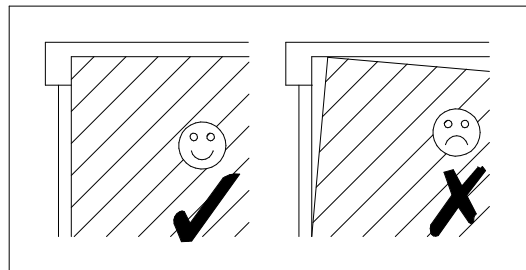
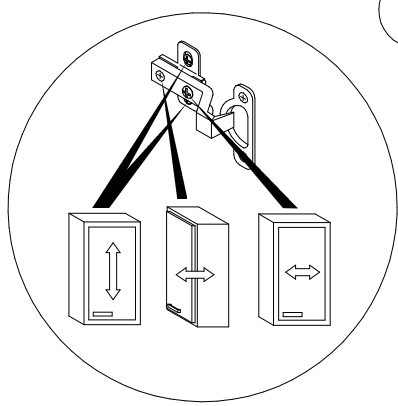
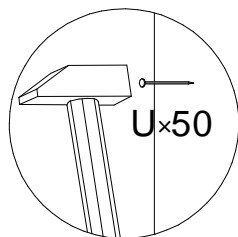
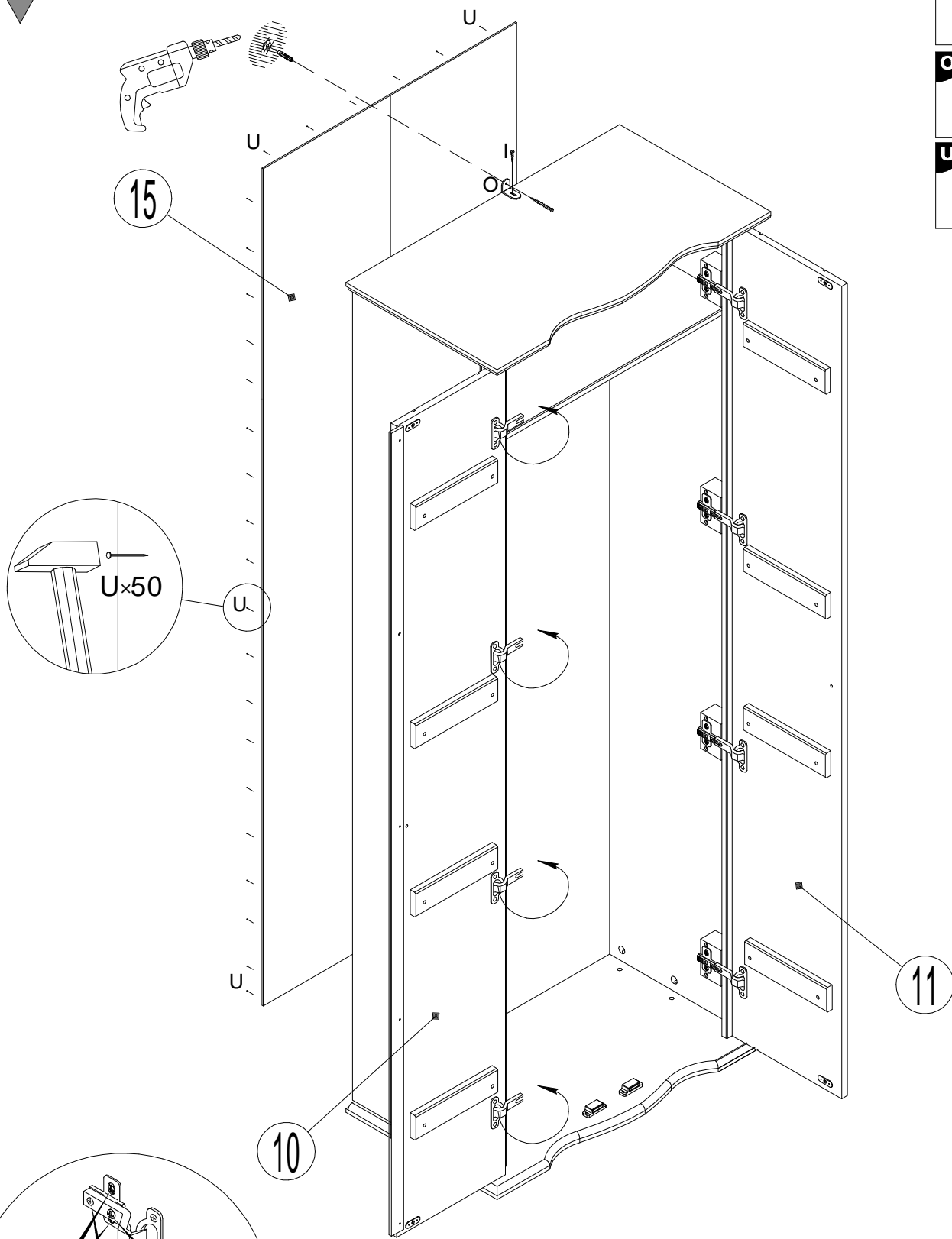



**Achtung • Attention • Attenzione
Opgelet • Uwaga • Pozor • Figyelem
Atenție • Dikkat • Внимание**



(D)	Wandbefestigung dient als Kippschutz – unbedingt anbringen! Bei einigen Wandtypen kann ein Spezialdübel erforderlich sein!
(GB)	The wall fastening serves to prevent tipping – be absolutely sure to mount it! For certain wall types, a special wall plug may be necessary!
(FR)	La fixation murale sert de protection contre le basculement – à installer impérativement ! Pour certains types de murs il faut des chevilles spéciales !
(IT)	Il fissaggio alla parete serve da protezione anti-ribaltamento – attaccarla assolutamente! Per alcune strutture di parete può essere necessario un tassello speciale!
(NL)	Bevestiging aan de muur dient als kantelbescherming – zeker en vast bevestigen! Bij enkele muurtypes is een speciale plug misschien vereist!
(PL)	Mocowanie do ściany jest jednocześnie zabezpieczeniem przed przewróceniem – koniecznie zamontować! Do niektórych rodzajów ścian koniecznie zastosować specjalne kołki mocujące.
(CZ)	Montáž na stěnu slouží jako ochrana proti převrnutí – bezpodmínečně umístěte! U některých typů stěn může být zapotřebí speciální hmoždinka!
(SK)	Upevnenie na stenu slúži ako ochrana proti prevráteniu – bezpodmienečne použite! Pre niektoré druhy stien môže byť potrebná špeciálna hmoždinka!
(HU)	A termékét a falhoz kel rögzíteni, különben az felborulhat! Egyes faltípusoknál speciális tiplit kell használni!
(RO)	Sistemul de fixare la perete servește ca protecție la răsturnare – de montat obligatoriu! Pentru unele tipuri de pereți este posibil să fie necesar un diblu special!
(TR)	Duvardaki sabitleme, devrilmeye karşı bir emniyet tedbiridir ve mutlaka monte edilmelidir! Bazı duvar tiplerinde bunun için özel bir dübel gerekli olabilir!
(RU)	Обязательно установите крепление на стене во избежание опрокидывания! Для некоторых типов стен может потребоваться специальный дюбель!