



Paulmann

### SafetyInstructions

1, 2, 3, 4, 5, 6, 7, 9, 10, 12, 13, 15, 16,  
17, 18, 19, 20, 21, 22, 24, 25, 26, 27,  
28, 33, 34



Info

[www.paulmann.com](http://www.paulmann.com)

Paulmann Licht GmbH  
Quezinger Feld 2  
31832 Springe  
Germany

[www.paulmann.com](http://www.paulmann.com)

Art. -Nr. :  
939.49  
939.50

(+MA 0326)PJI 08/17

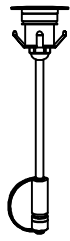

3x

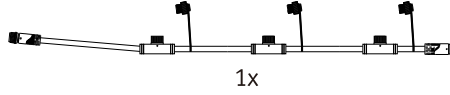

1x

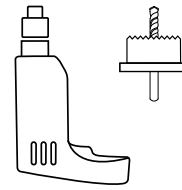

A1 A2



Safety  
Instructions  
Nr. 3,4,5,6,7 off



$\varnothing 39\text{mm}$

90mm

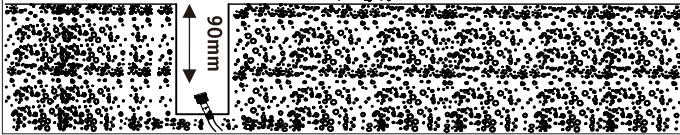

A1 A2

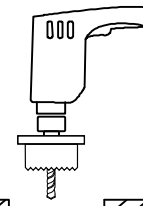

$\varnothing 35\text{mm}$

3-20mm

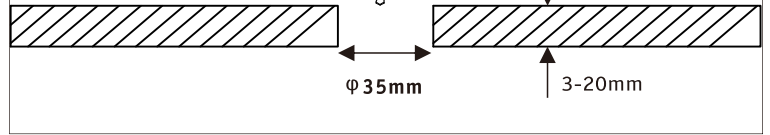

B

i IP 65

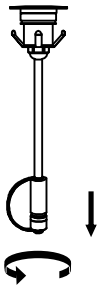

C

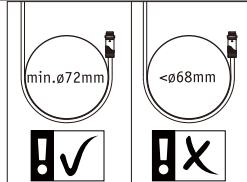

i IP 68

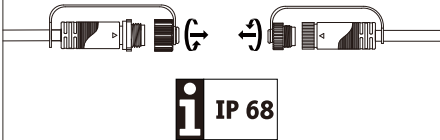

D

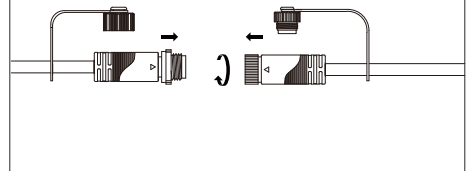
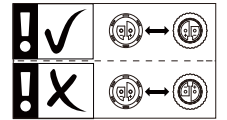

E

max. 50m  
max. 150W

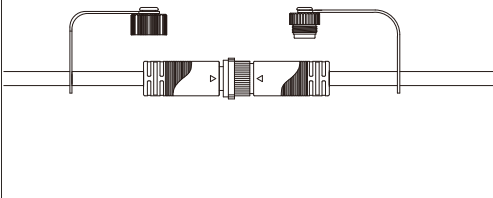

F1 F2

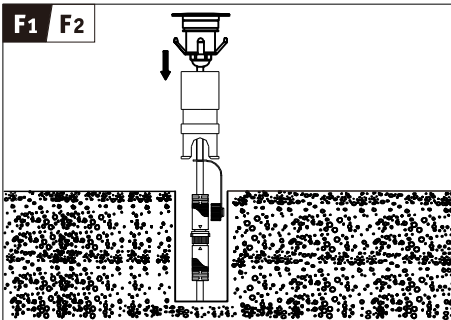

F1 F2

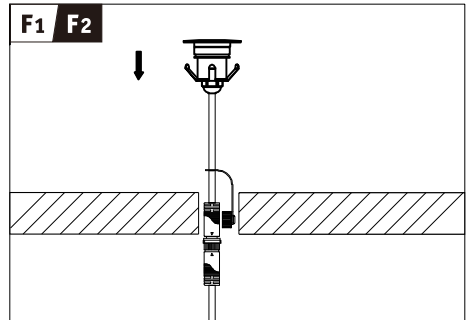

G1 G2

230V

i IP 65

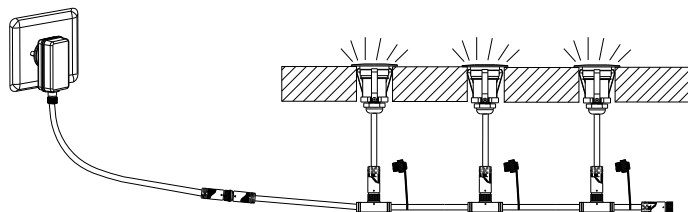

G1 G2

not incl.

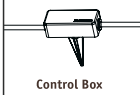

Control Box  
Remote Control  
Paulmann  
Art.-Nr. 180.11

230V

i IP 65

