



A030.130.00



1



2



3

2x

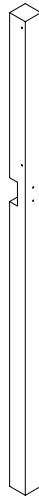

4

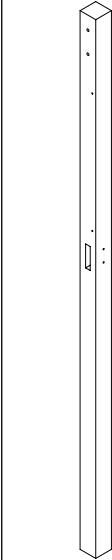

5



6

2x



59

2x

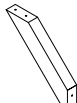

7

2x

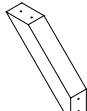

8

12x



9

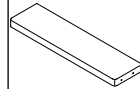

10

7x

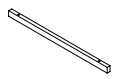

11

3x

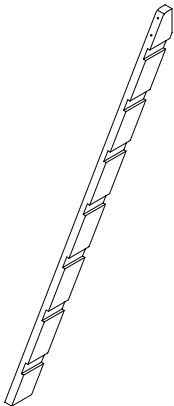

12

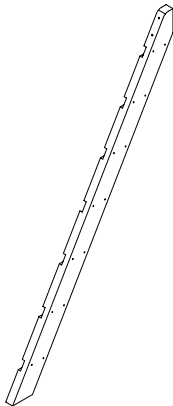

13

M8

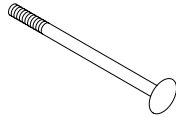

b8

3x

M8



c4

3x

M8



m5

3x



s1

34x



s2

36x

s5

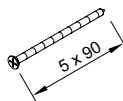

56x

s7

1x

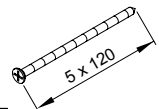



A030.128.00

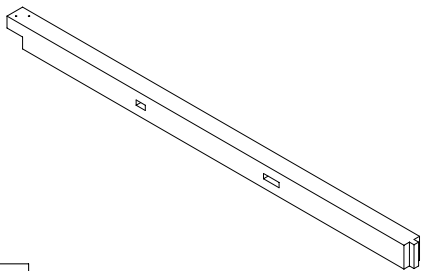

14

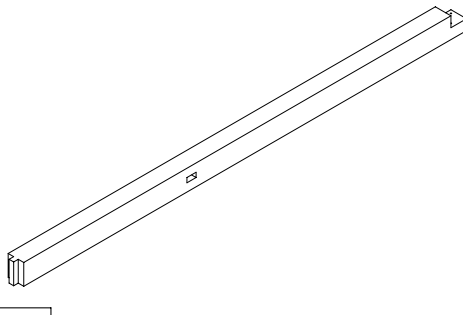

15

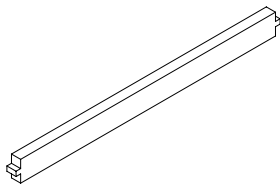

16

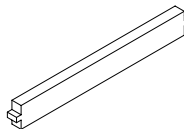

17

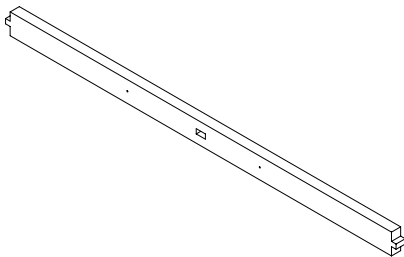

18

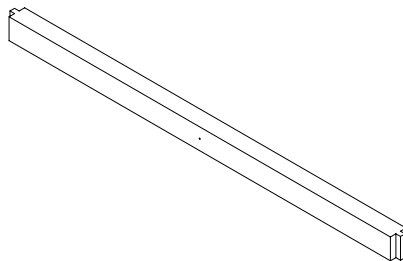

19

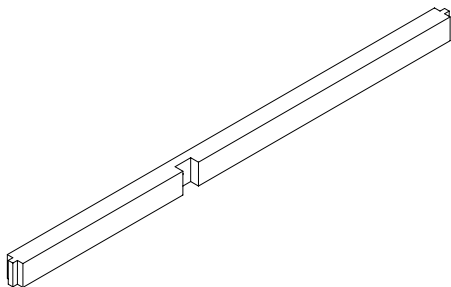

20

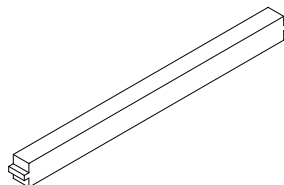

21



A030.131.00

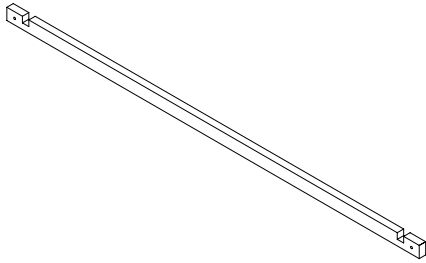

22

2x

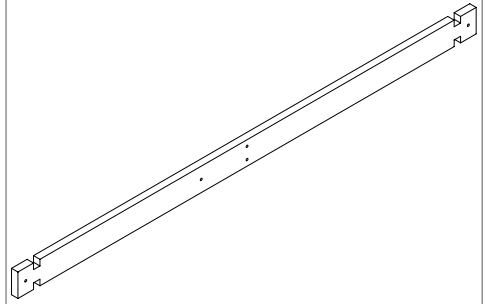

23

2x

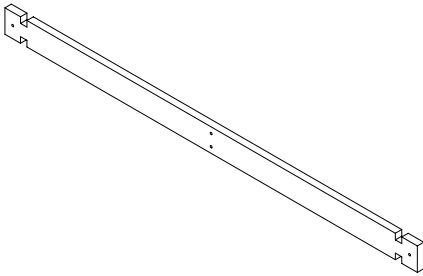

24

2x

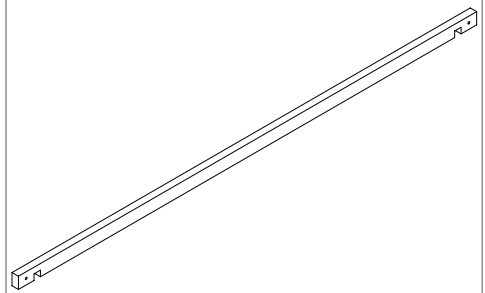

25

2x

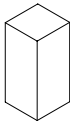

26

4x

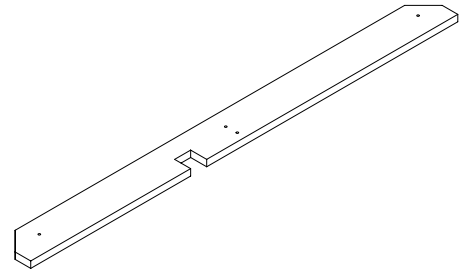

27

2x

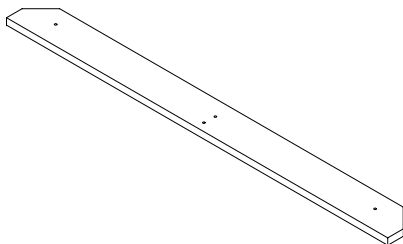

28

2x

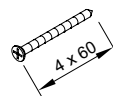

s2

40x



A030.129.00

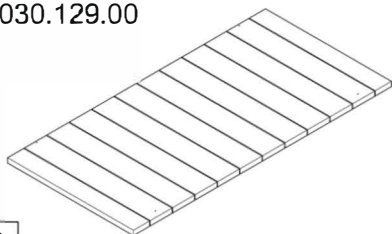

29

2x

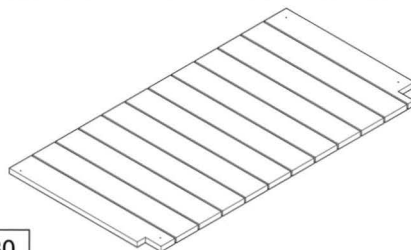

30

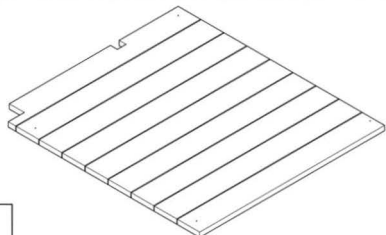

31

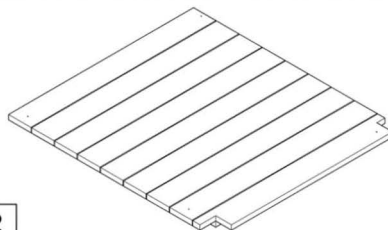

32

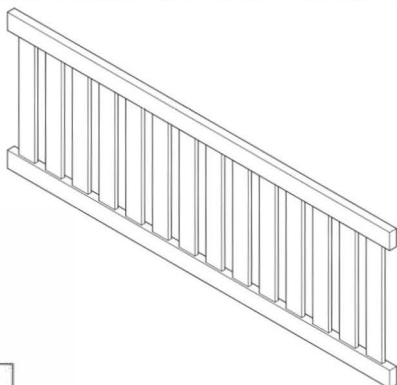

33

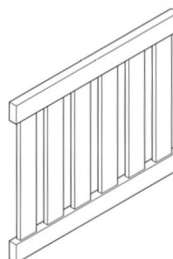

34

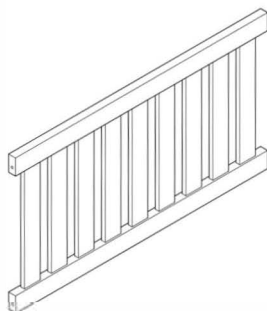

35



36

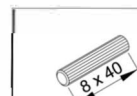

d2

2x



s1

20x



s2

1x



s5

2x

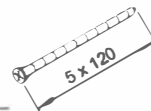

s7

12x

A030.046.00

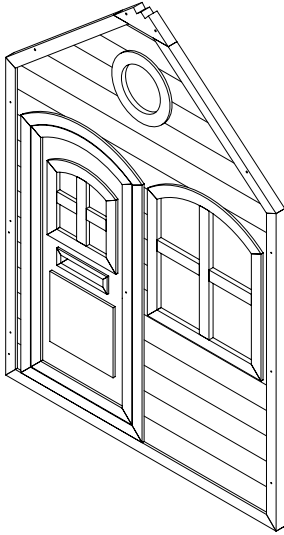

37

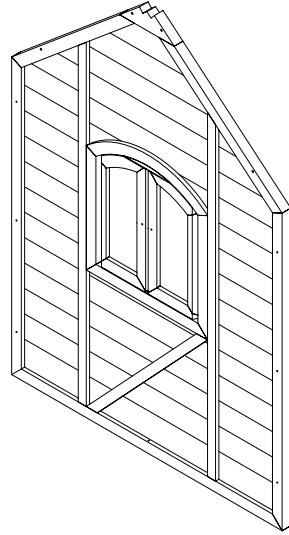

38



39

14x

t1

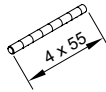

7x

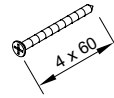

s2

24x

A030.047.00

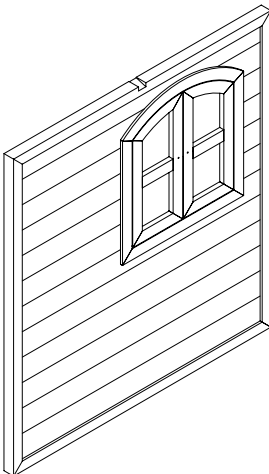

40

2x

A030.033.00

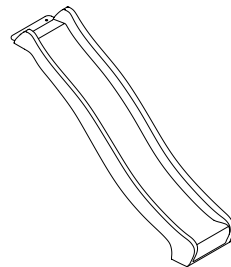

41

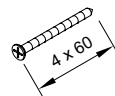

s2

2x



A030.048.00

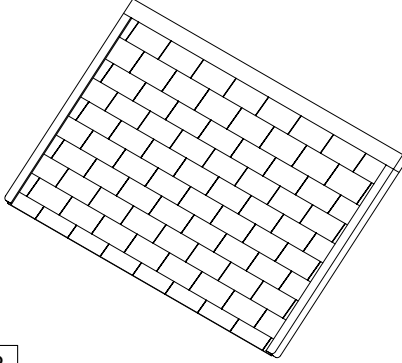

42

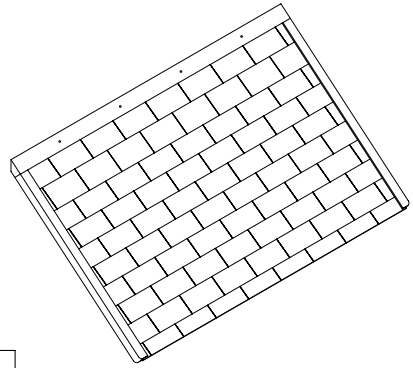

43

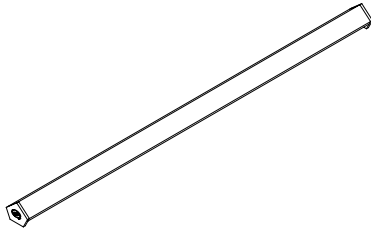

44

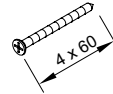

S2

8x



S3

14x

A030.066.00

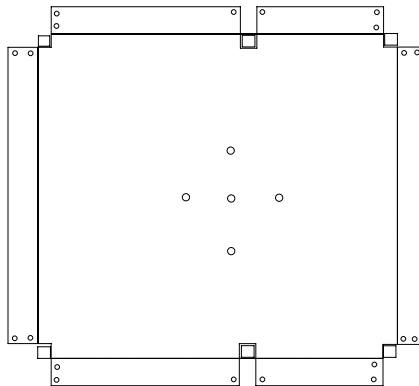

45



A030.204.00



49



50

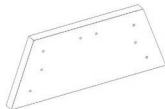

51



52

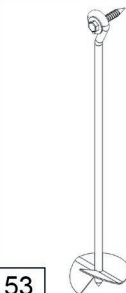

53

2x

M8 x 90



b8

M8

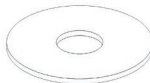

c4

M8

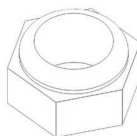

m5

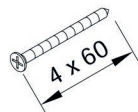

s2

20x

A030.205.00



54

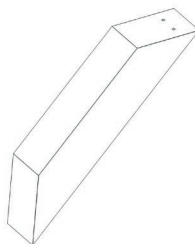

55

2x



56

4x

A030.206.00

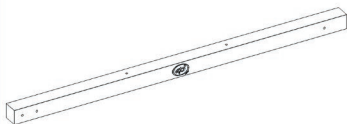

57

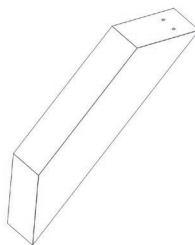

55

2x



56

2x



Liam / Atka

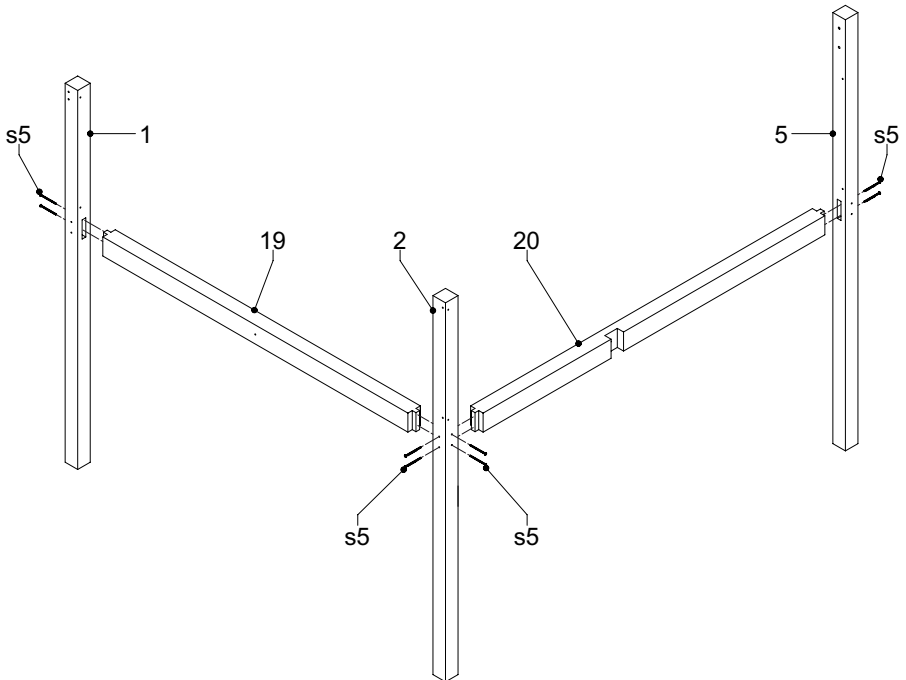

1		2		5		19		20		s5		8x
---	--	---	--	---	--	----	--	----	--	----	--	----

A030.128.00 + A030.130.00



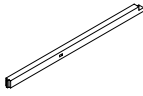

Liam / Atka

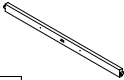
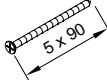
				
15	3	17	18	s5

8x

A030.128.00 + A030.130.00

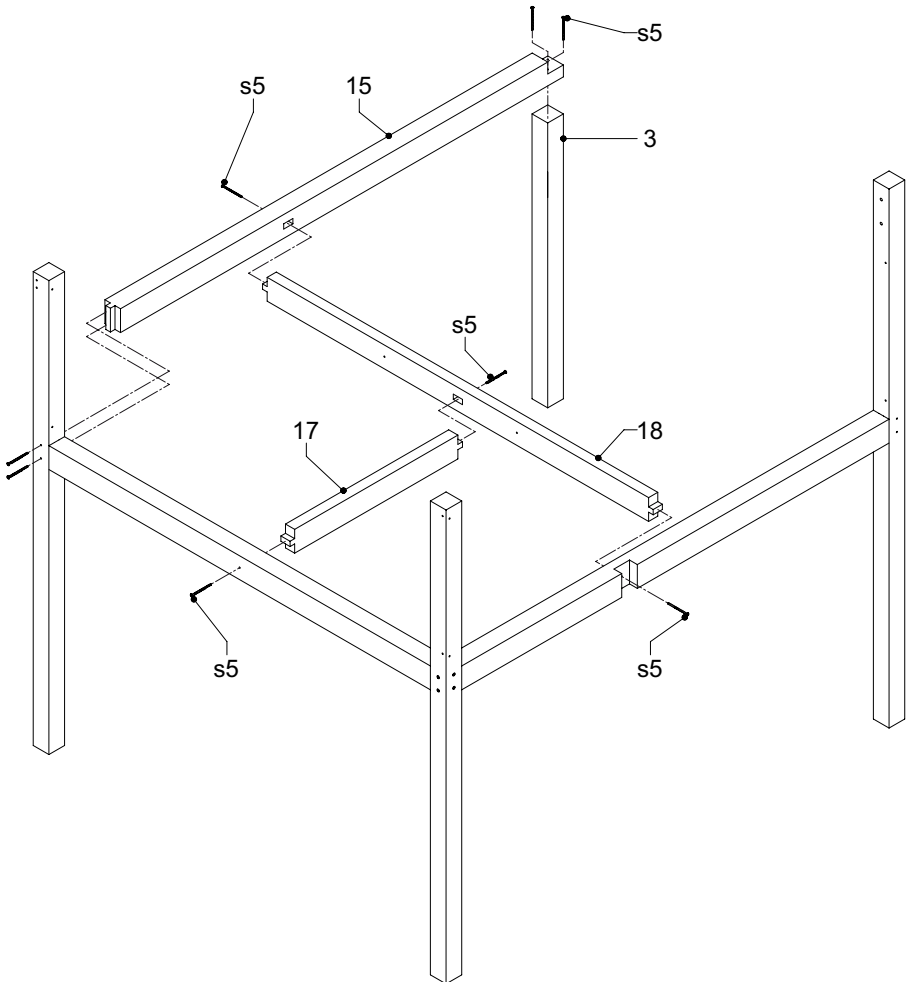



Liam / Atka



16



21

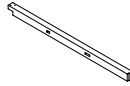

14

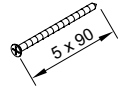

s5

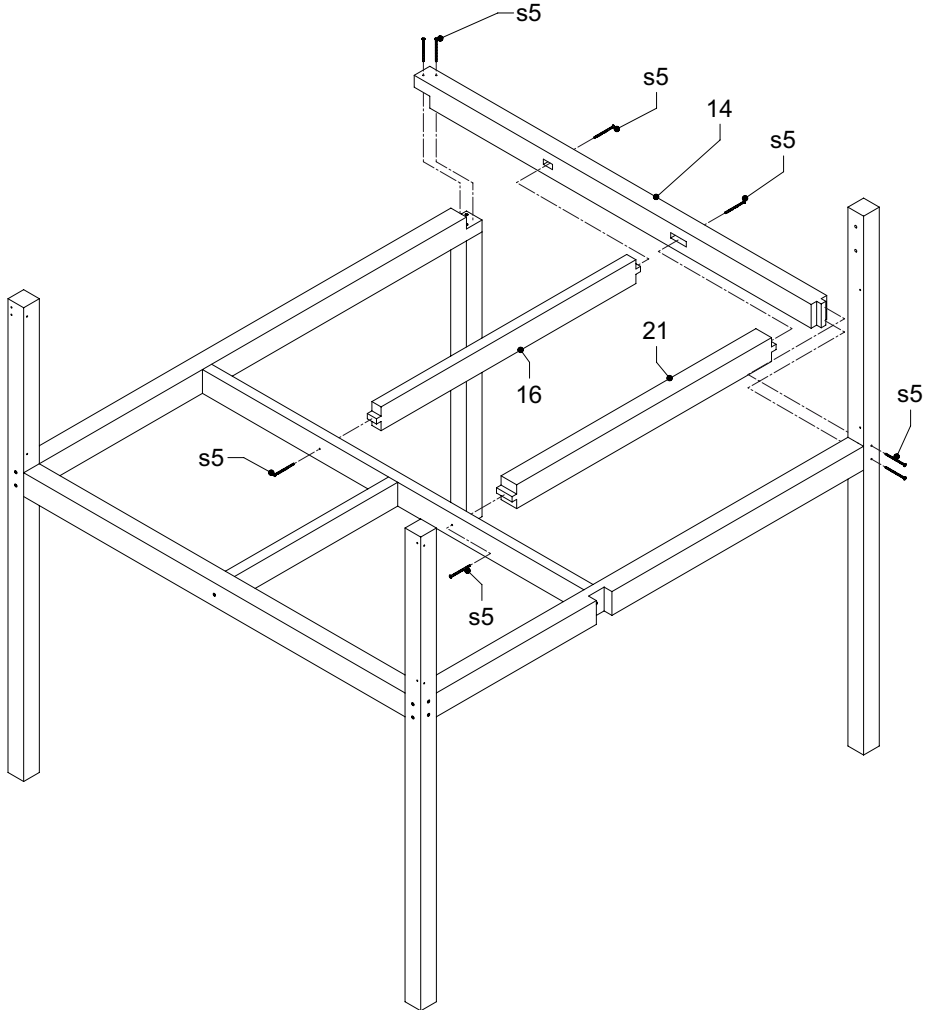

8x

A030.128.00 + A030.130.00



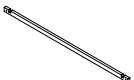
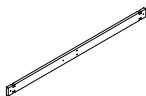
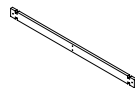
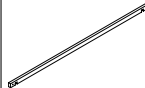

Liam / Atka

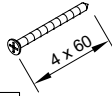
											
22	2x	23	2x	24	2x	25	2x	26	4x	s2	24x

A030.131.00

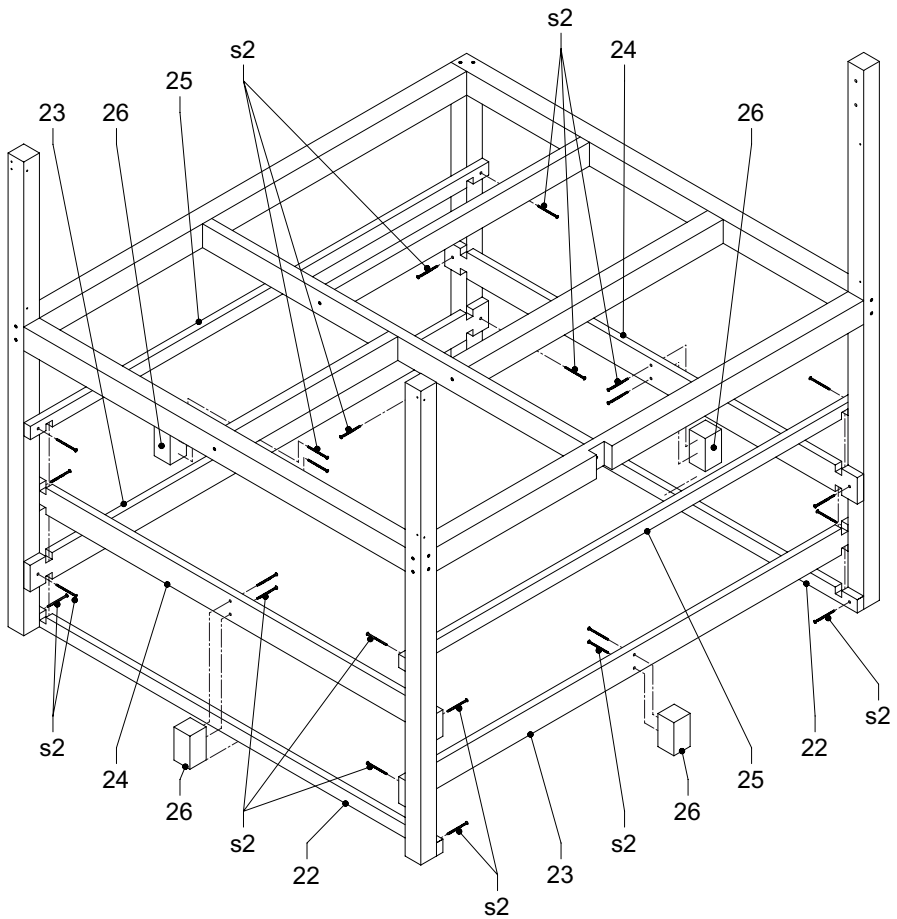



Liam / Atka

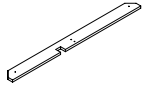

27

2x

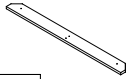

28

2x

3



4



s2

4 x 60

20x

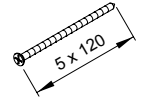



s7

5 x 120

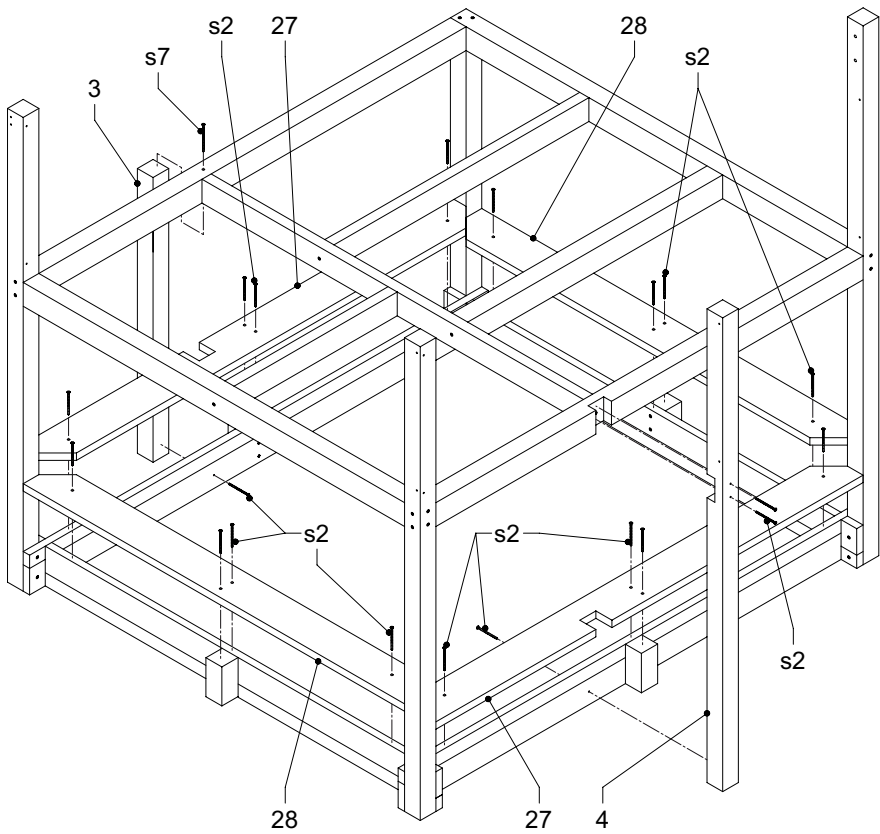
A030.130.00 + A030.131.00



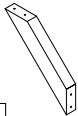
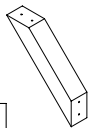

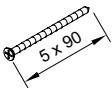
								
7	2x	8	12x	s2	28x	s5	28x	

A030.130.00

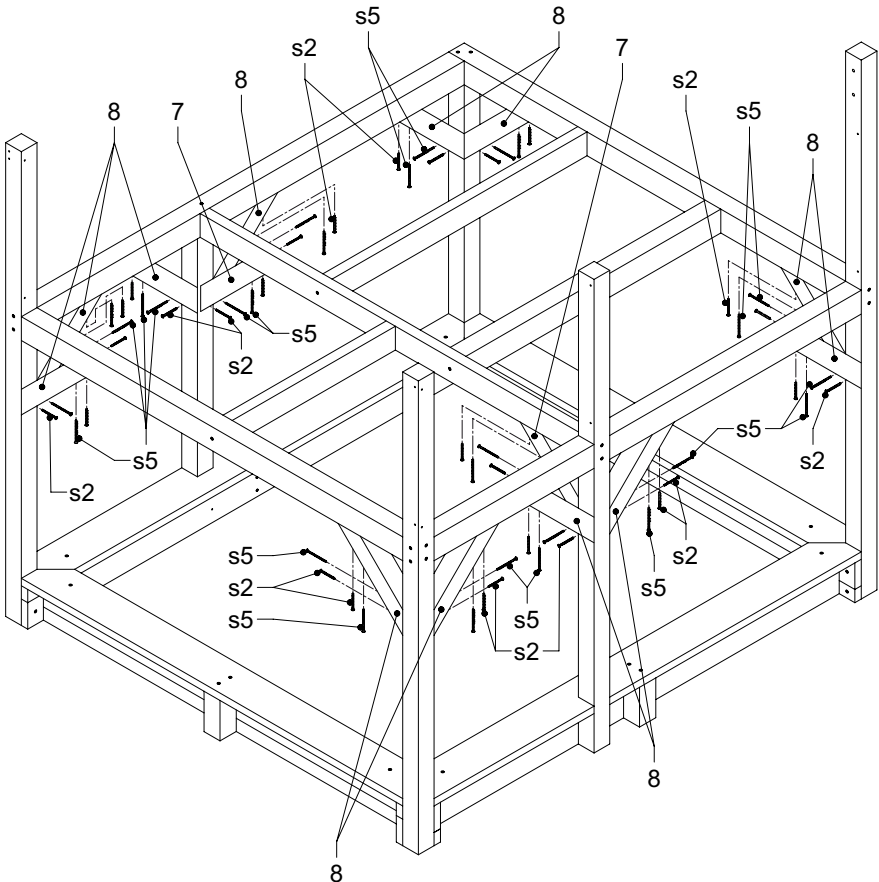



Liam / Atka

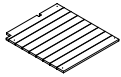

31



32

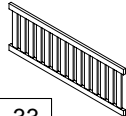

33



34



35

s1



8x

d2



2x

s7

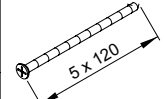

10x

A030.129.00

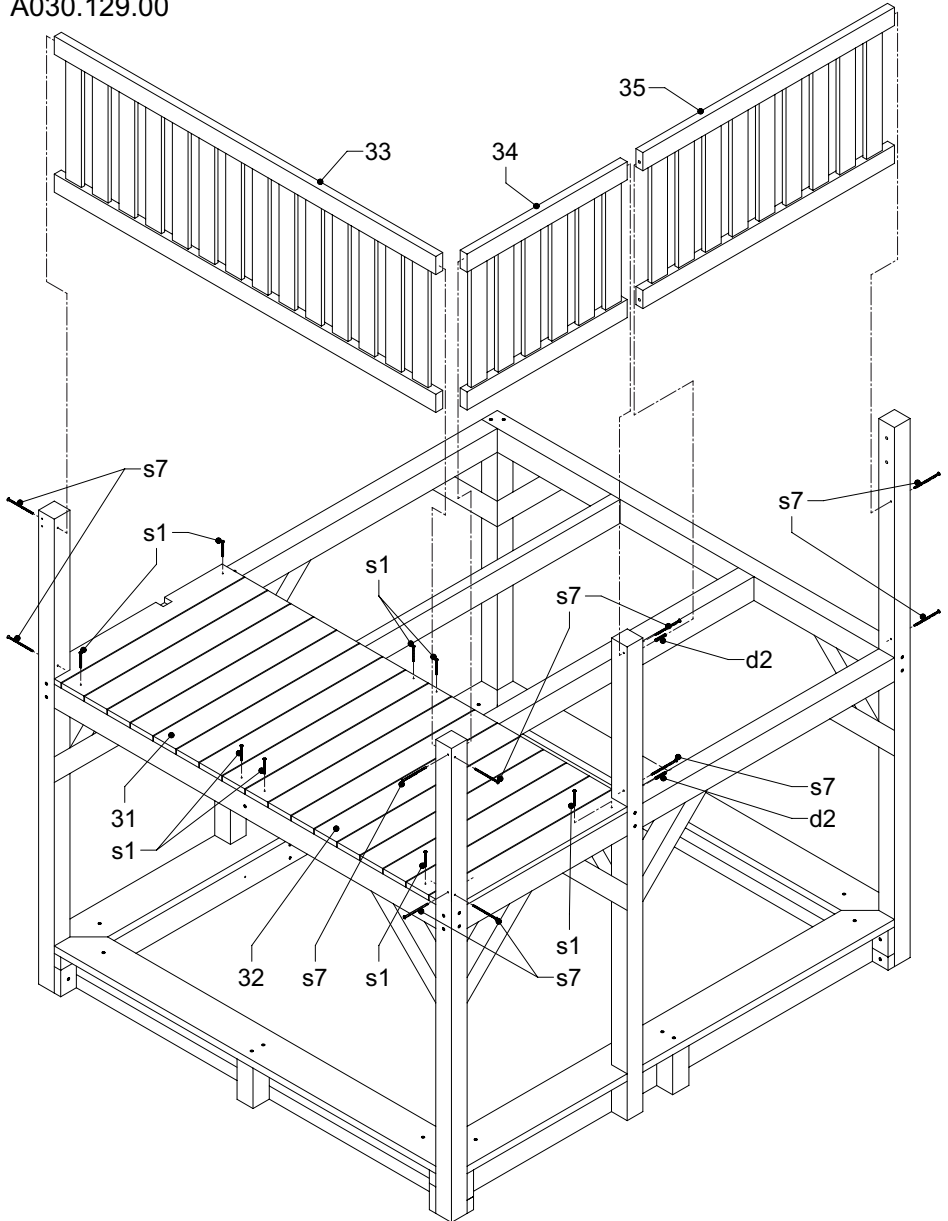



Liam / Atka



30

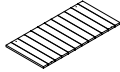

29

2x



36

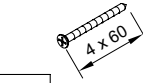

s2

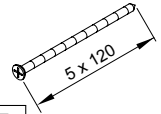

s7

2x

A030.129.00

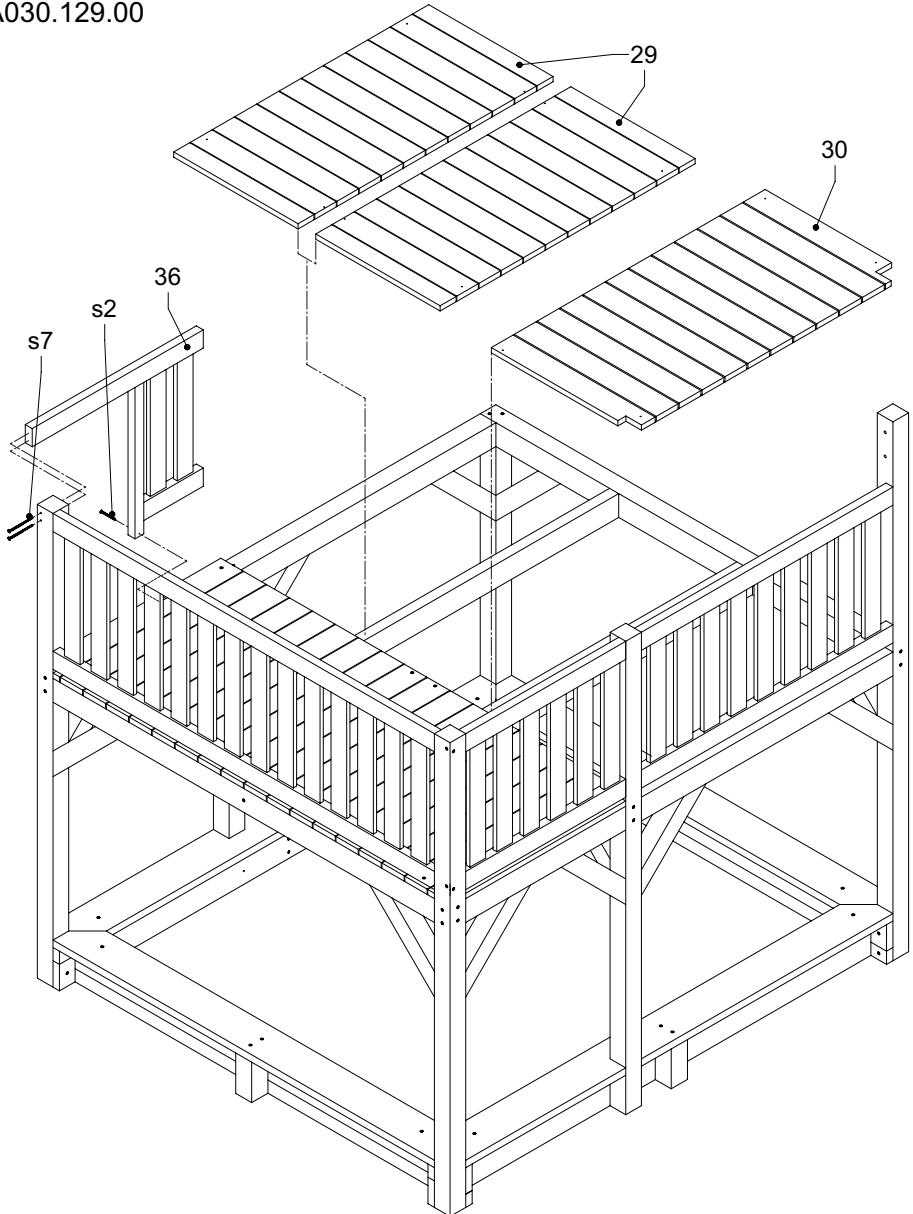



Liam



37



s2

3x

39



2x

t1

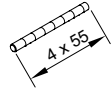

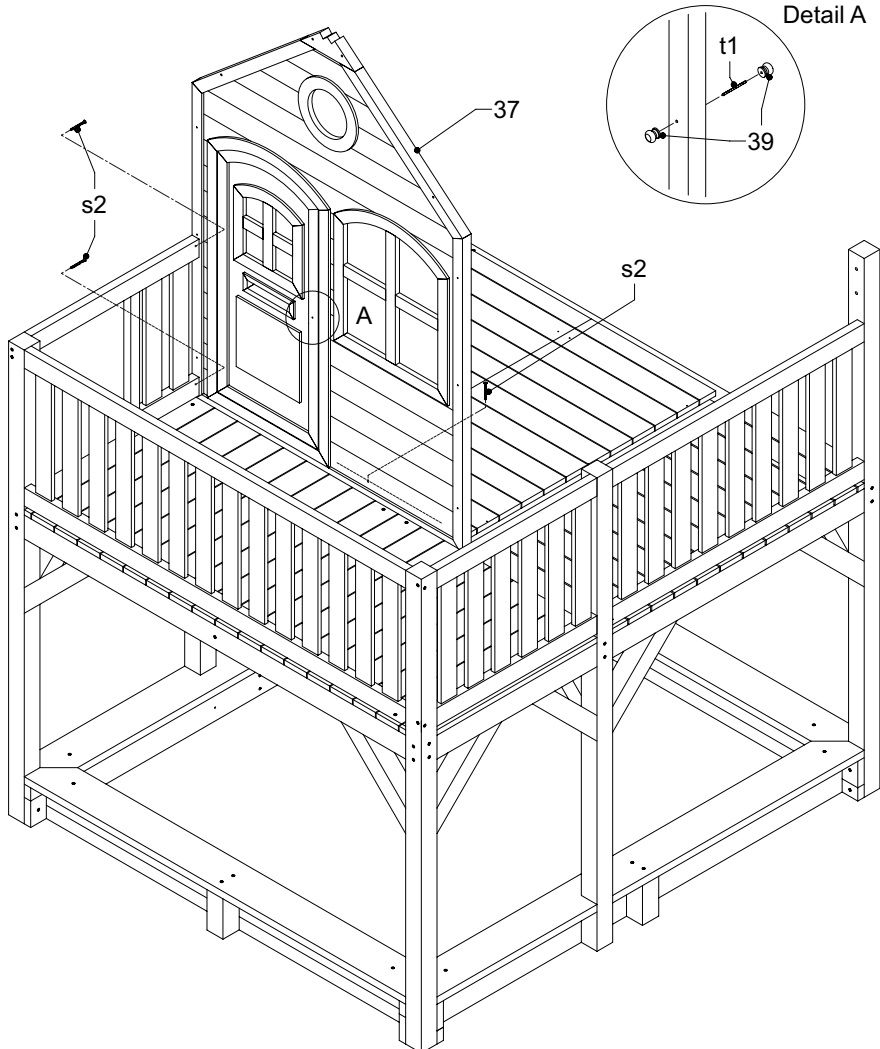

A030.046.00



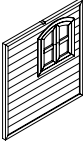

Liam

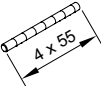
			
40	2x s2	8x 39	8x t1
			4x

A030.046.00 + A030.047.00

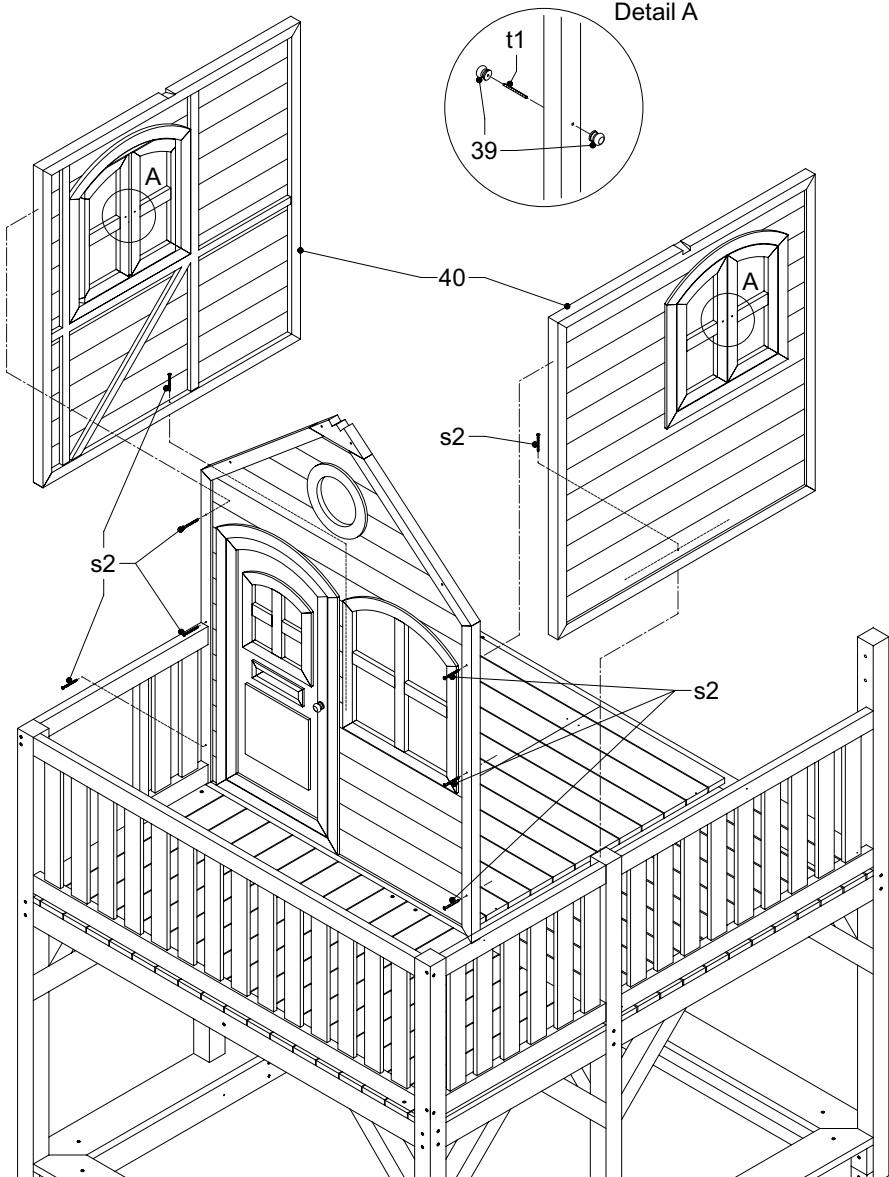



Liam

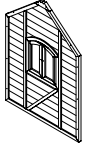

38



s1

12x



s2

7x

39



4x

t1

2x

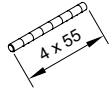

A030.046.00 + A030.047.00 + A030.129.00

Detail A

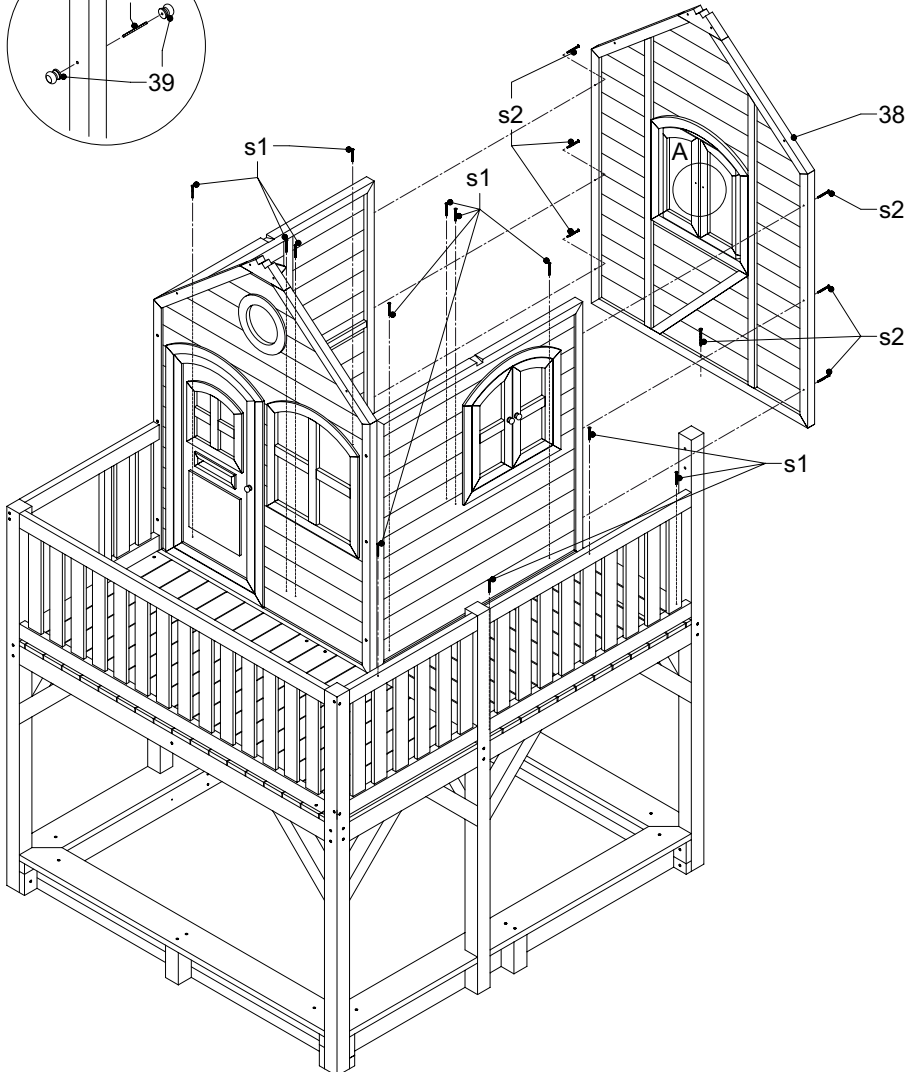
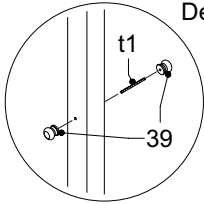

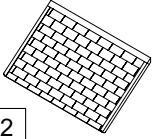

42

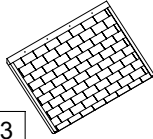

43

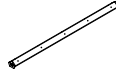

44



s2

8x



s3

14x

A030.048.00

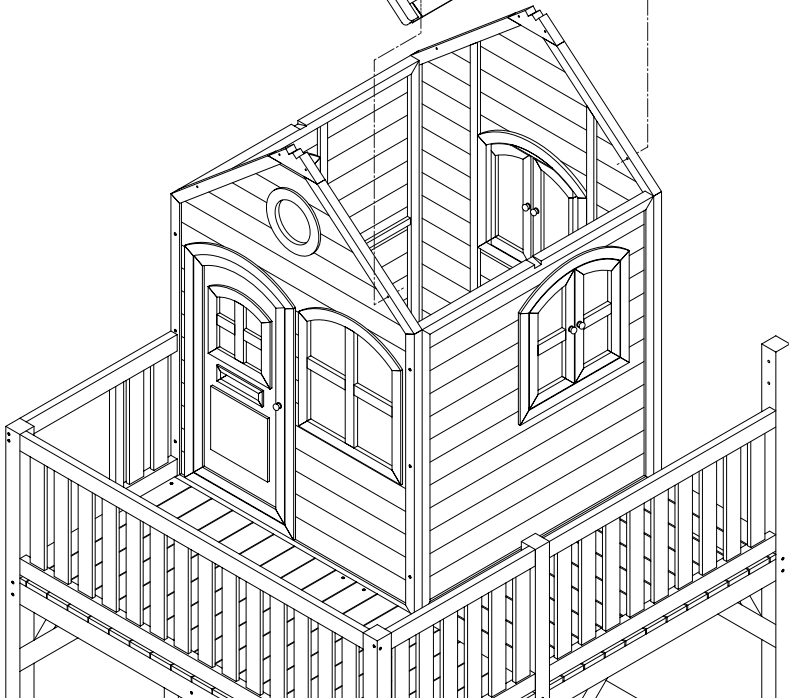
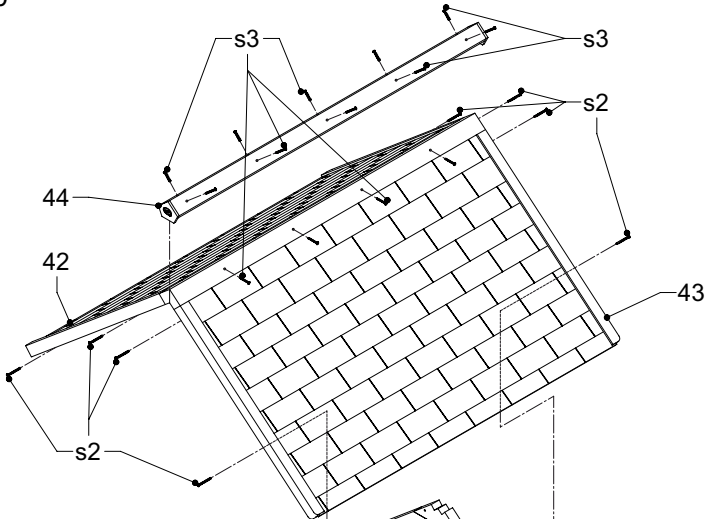



Liam

12	13	10 7x	11 3x	s1 34x	s5 4x	41	s2 2x

A030.033.00 + A030.130.00

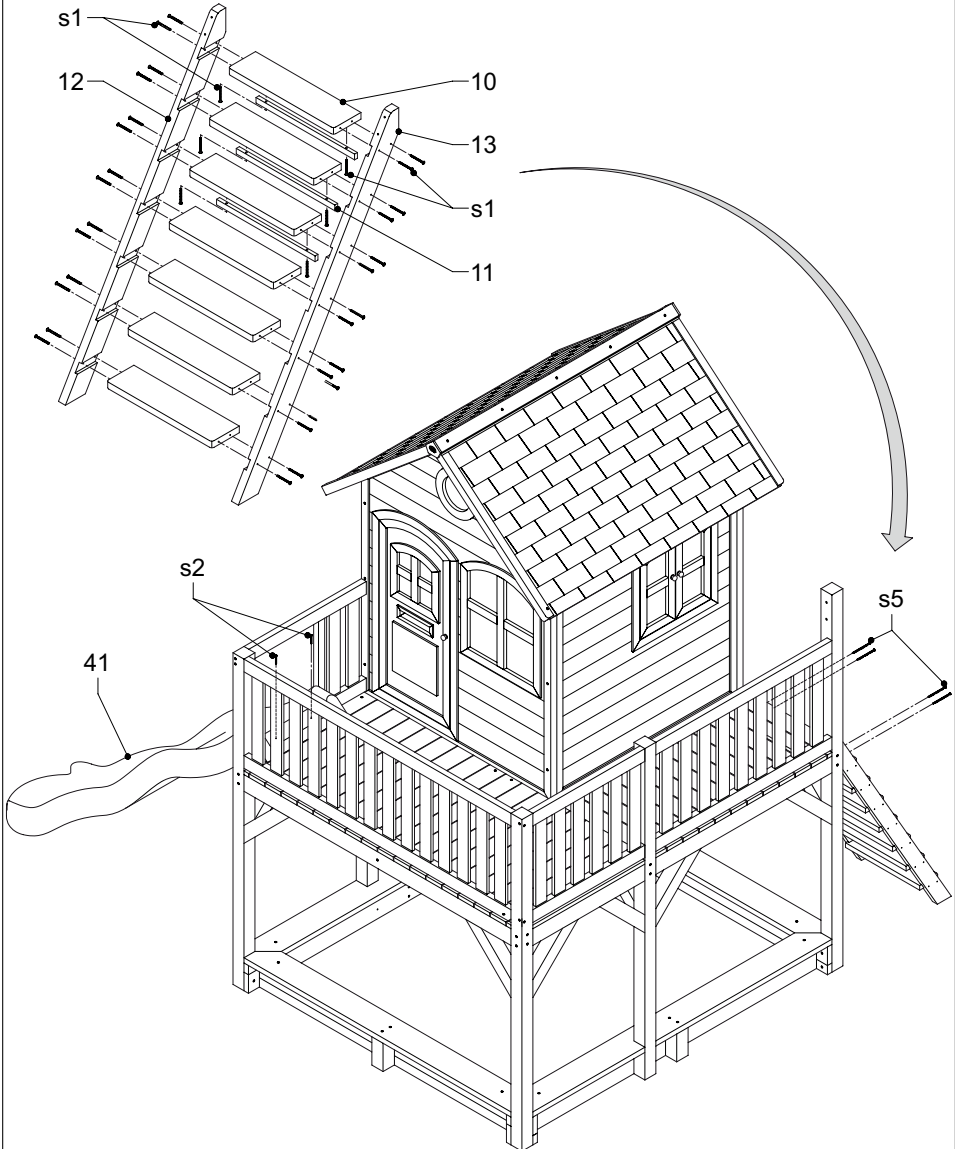



Liam / Atka

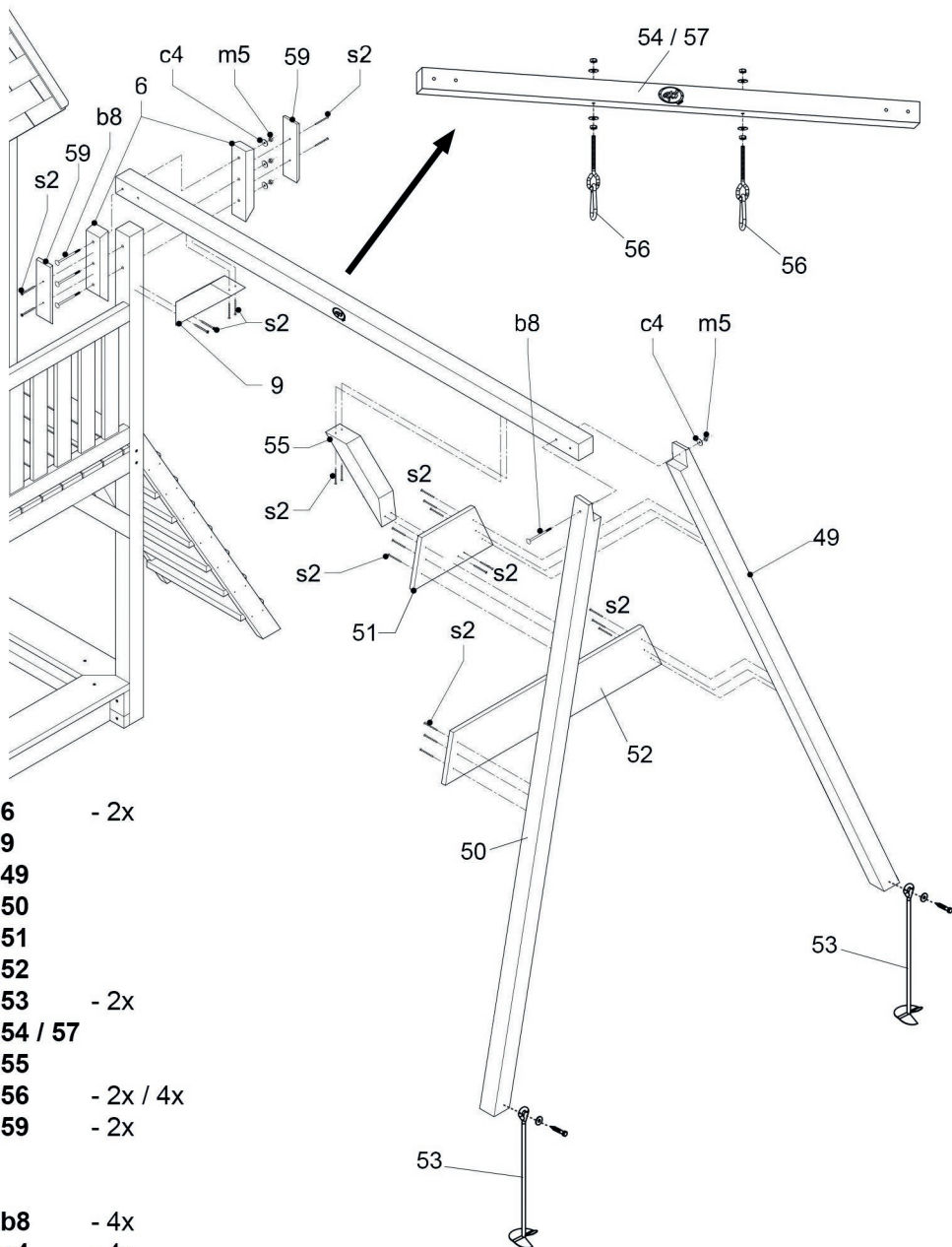

- 6** - 2x
- 9**
- 49**
- 50**
- 51**
- 52**
- 53** - 2x
- 54 / 57**
- 55**
- 56** - 2x / 4x
- 59** - 2x

- b8** - 4x
- c4** - 4x
- m5** - 4x
- s2** - 20x