

5 Drawer dresser

8599013CO

Service • Assistenza • Dienstverlening • Serwis Servis • Szerviz • Сервисная служба	
Name • Nom • Nome • Naam • Nazwa • Jméno • Názov • Név • Denumire • İsim • Название	Quincy
	

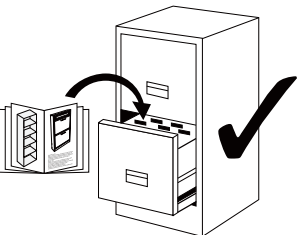

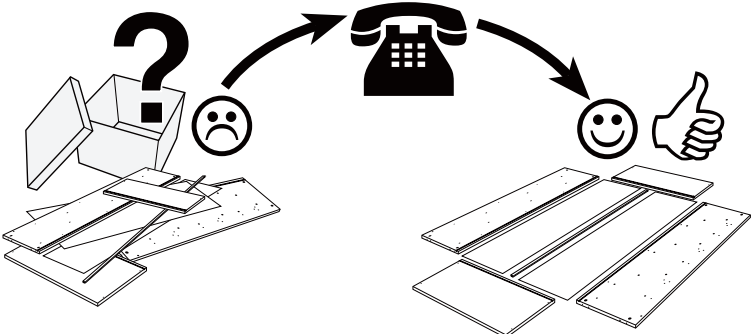
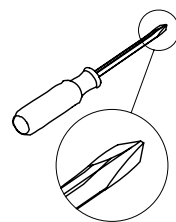
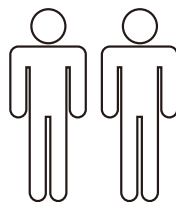
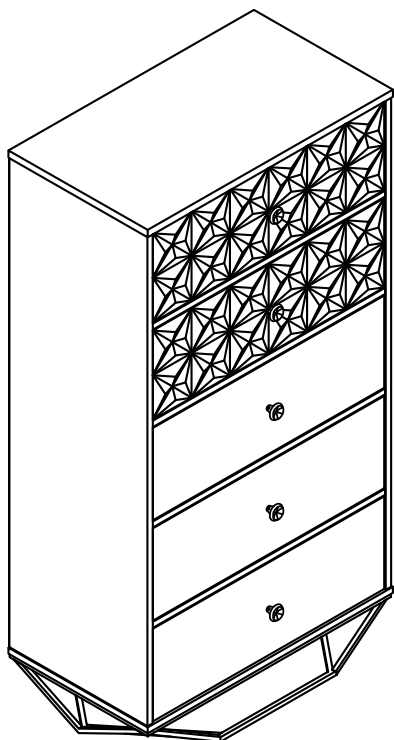

- (D) Montageanleitung
- (FR) Notice de montage
- (NL) Handleiding voor de montage
- (CZ) Montážní návod
- (HU) Szerelési útmutató
- (TR) Montaj talimati
- (GB) Assembly instructions
- (IT) Istruzioni di montaggio
- (PL) Instrukcja montażu
- (SK) Návod na montáž
- (RO) Instrucțiuni de montaj
- (RU) Инструкция по монтажу

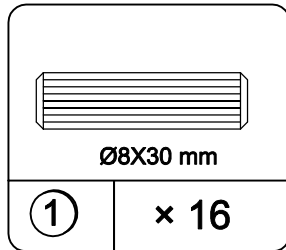
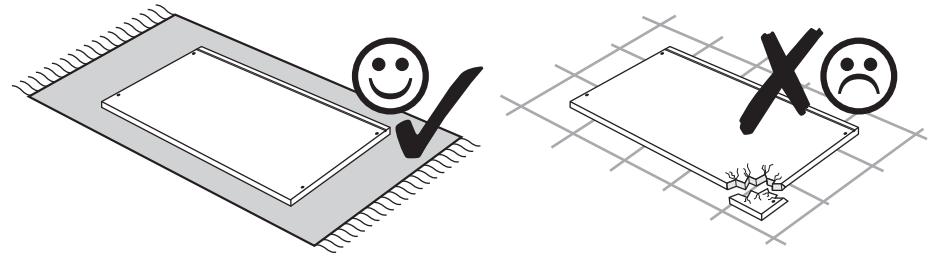
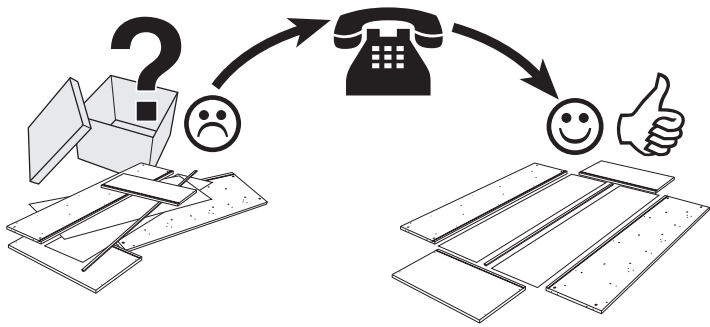

TKX1005

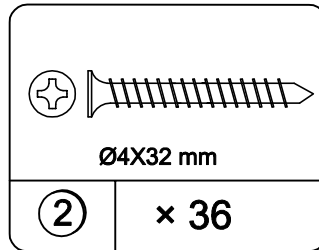

TKX1456

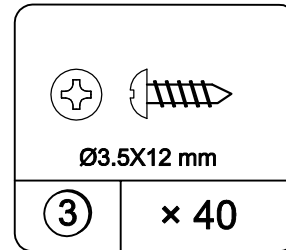

TKX1018

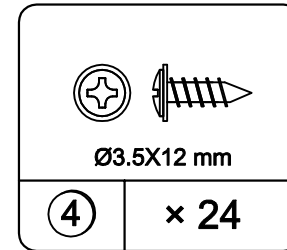

TKX1175

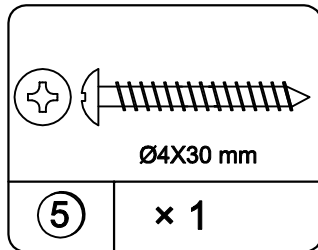

TKX1039

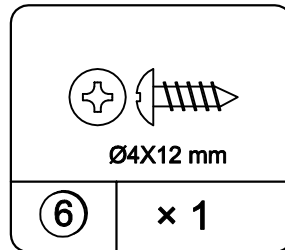

TKX1037

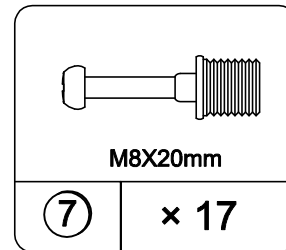

TKX1191

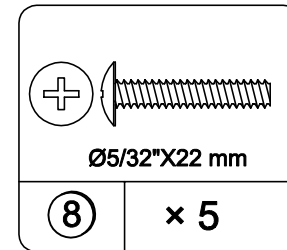

TKX1444

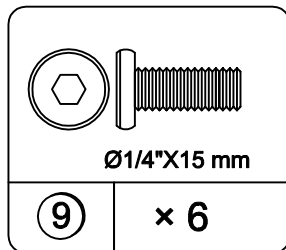

TKX1219

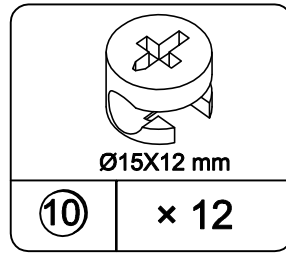

10 × 12

TKX1010

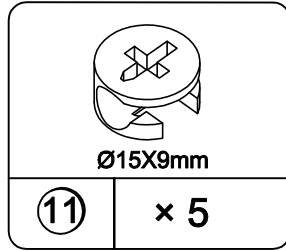

11 × 5

TKX1011

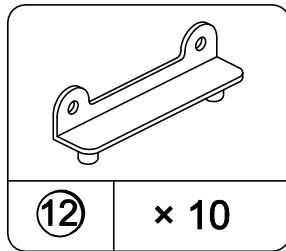
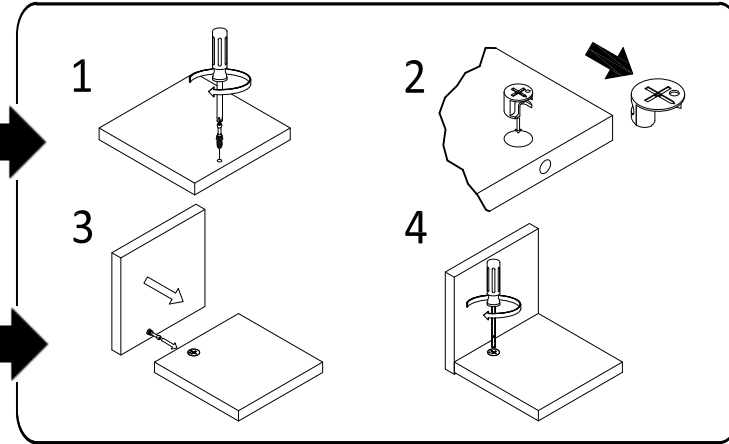

12 × 10

TKX1313

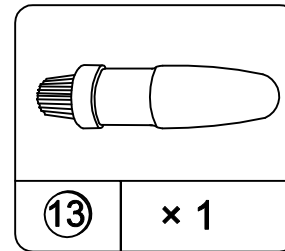

13 × 1

TKX1014

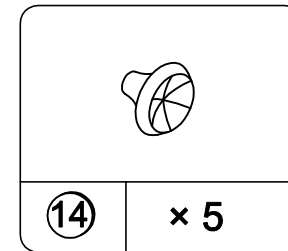

14 × 5

TKX1461

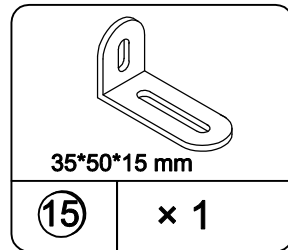

15 × 1

TKX1026

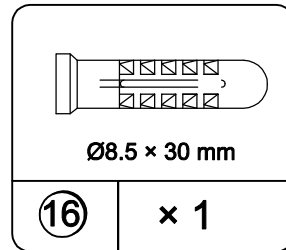

16 × 1

TKX1042

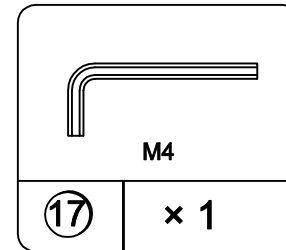

17 × 1

TKX1140

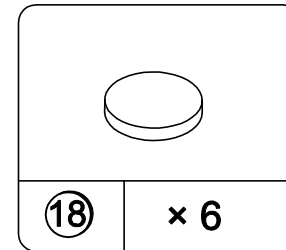

18 × 6

TKX1557

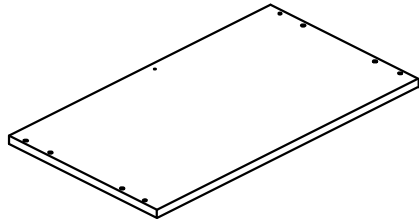

(A)

T8599013010KX

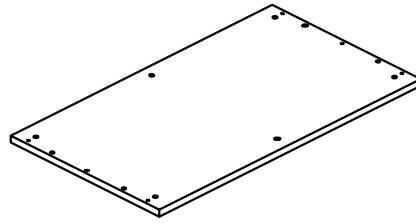

(B)

T8599013020KX

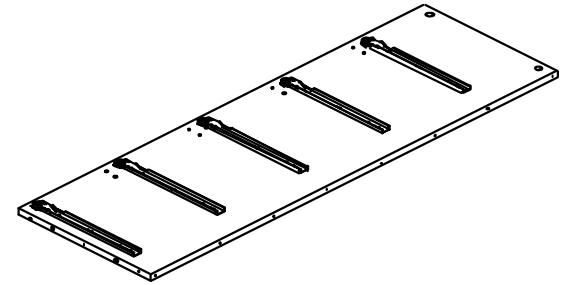

(C)

T8599013030KX

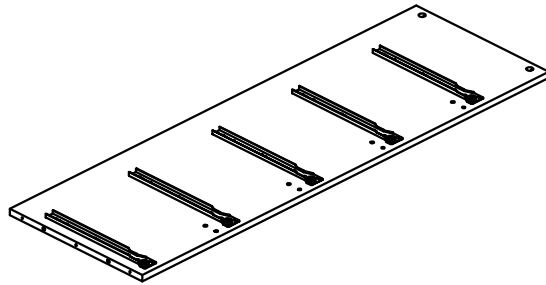

(D)

T8599013040KX

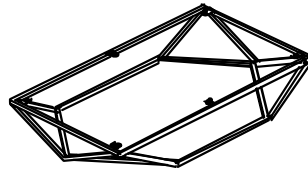

(E)

T8599013050KX

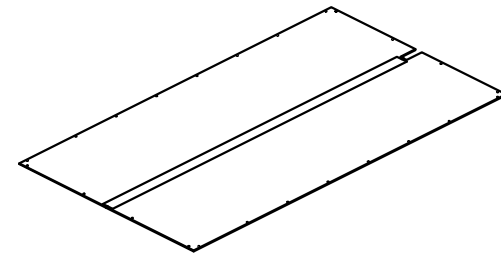

(F)

T8599013060KX

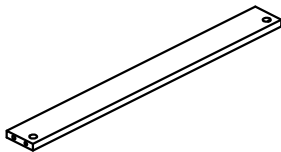

(G)

T8599013070KX
x 4

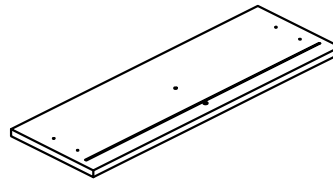

(H)

T8599013080KX
x 2

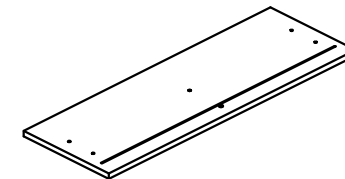

(I)

T8599013090KX
x 3

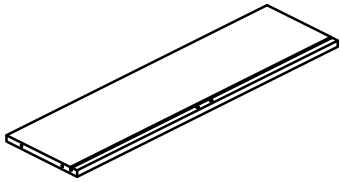

J

T8599013100KX
x 5

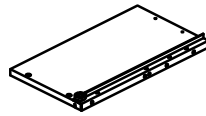

K

T8599013110KX
x 5

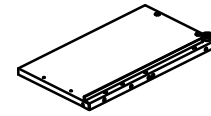

L

T8599013120KX
x 5

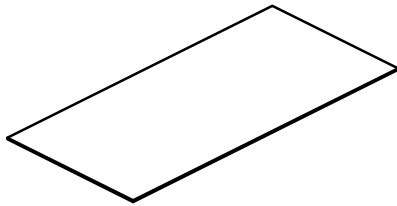

M

T8599013130KX
x 5

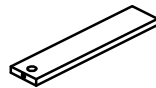

N

T8599013140KX
x 5

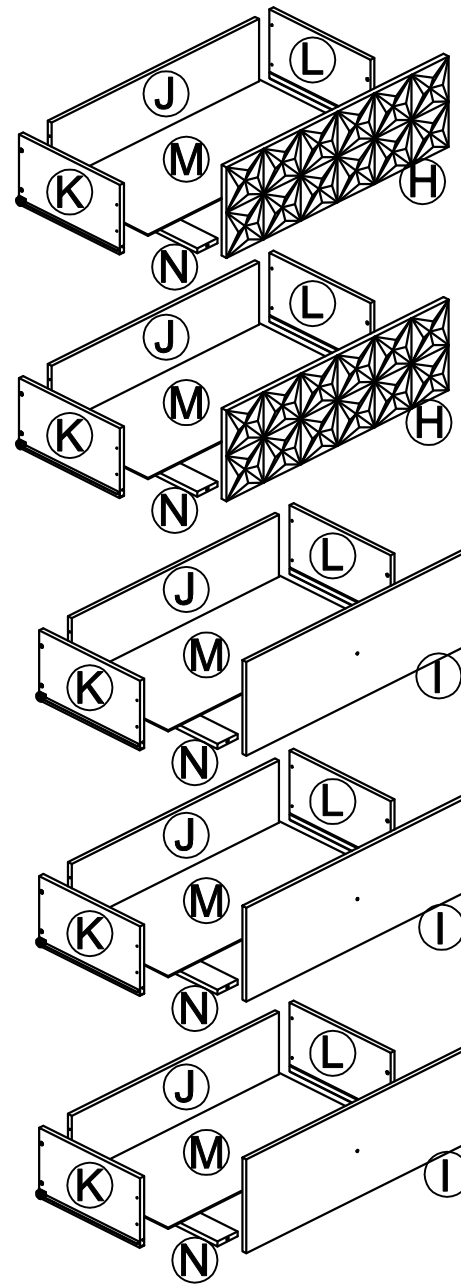
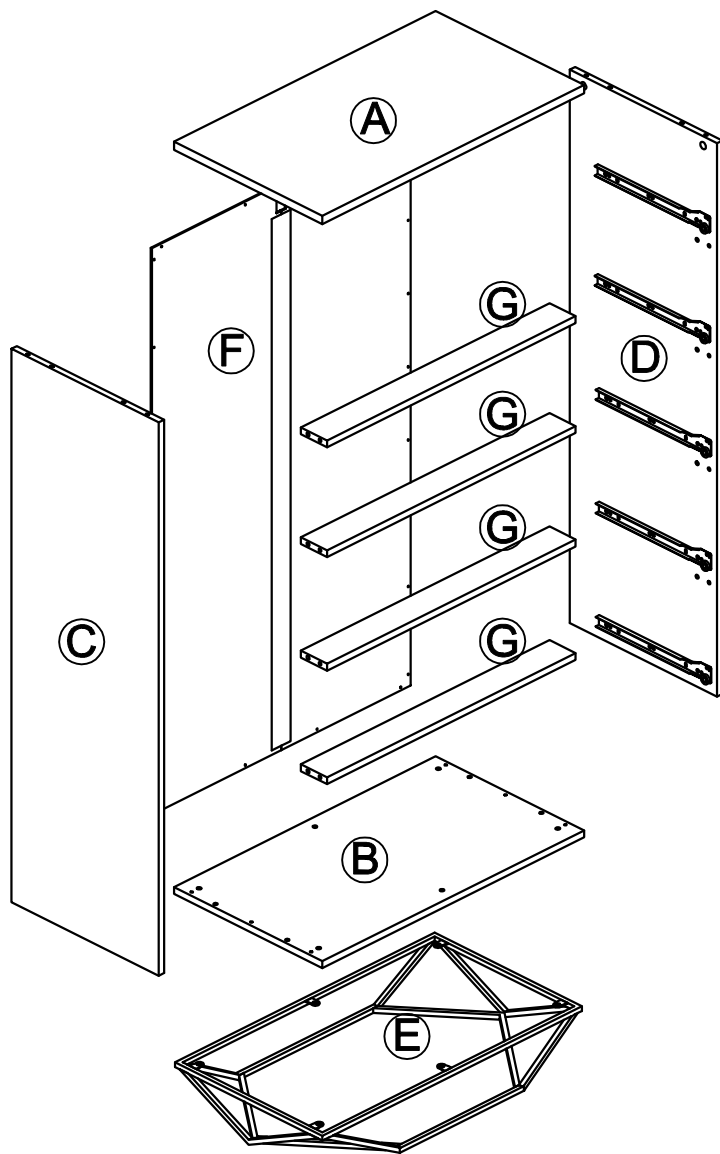

1

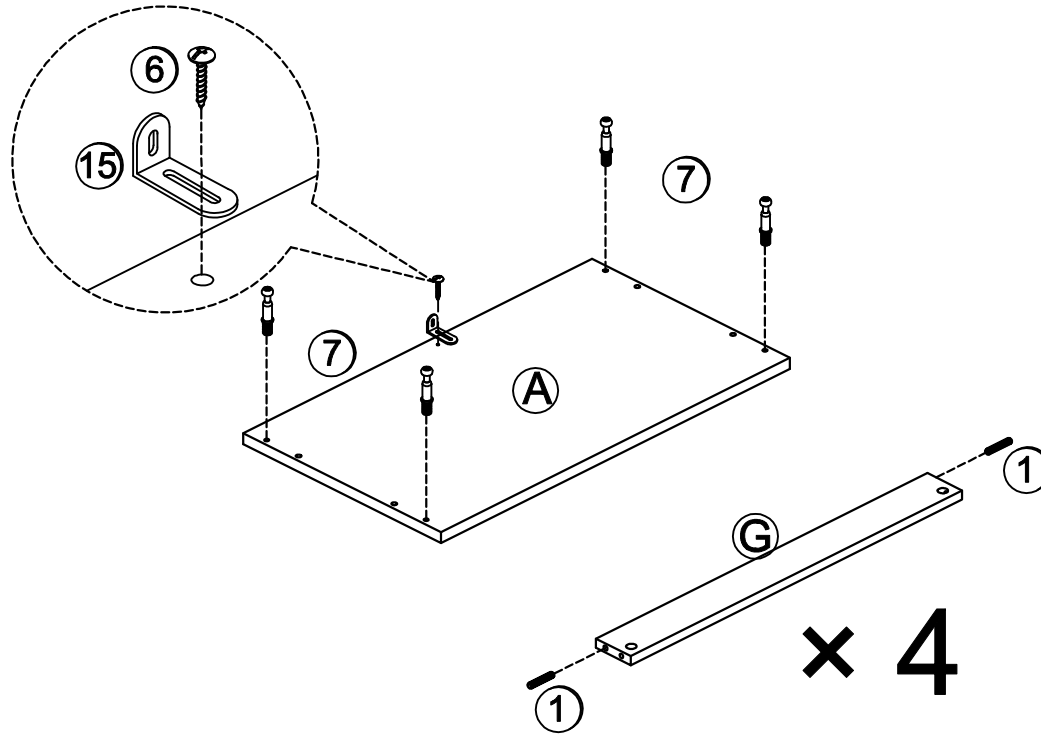
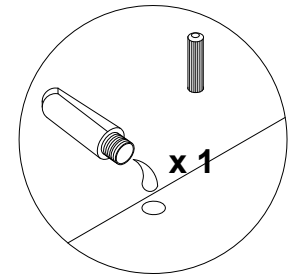
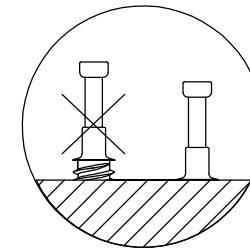
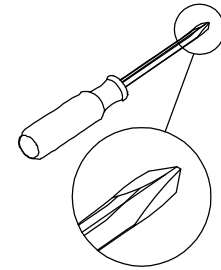
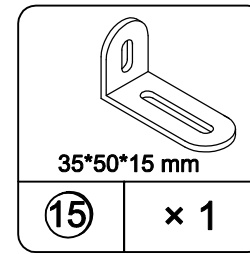
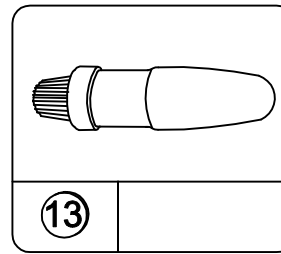
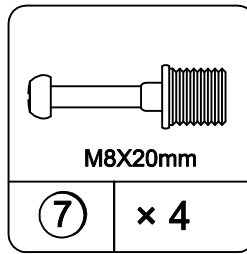
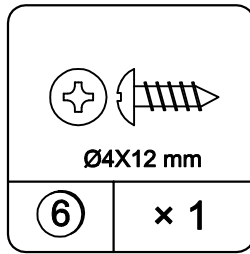
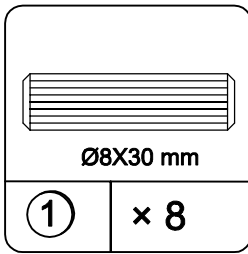

2

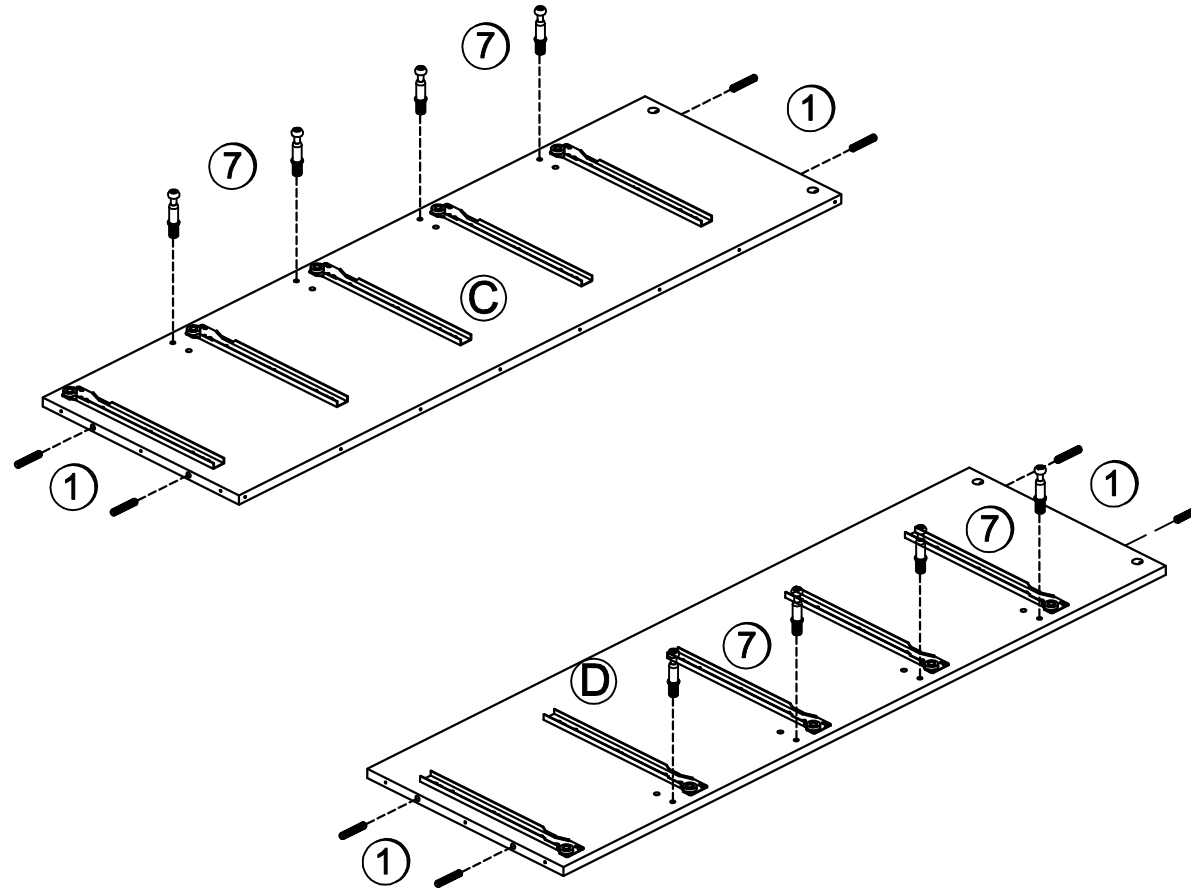
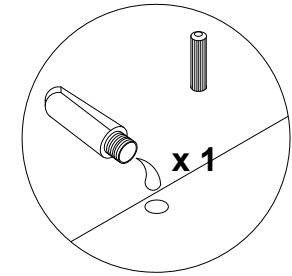
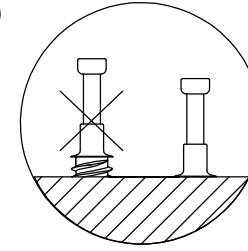
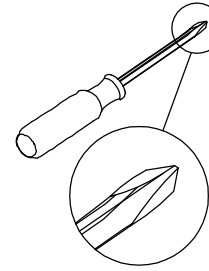
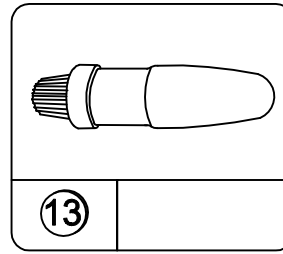
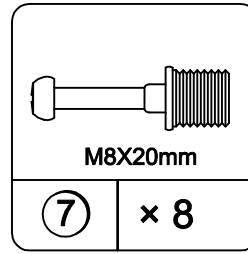
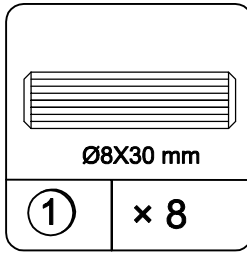

3

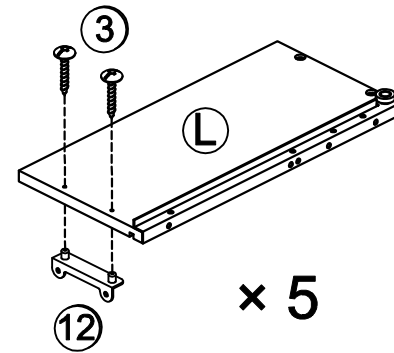
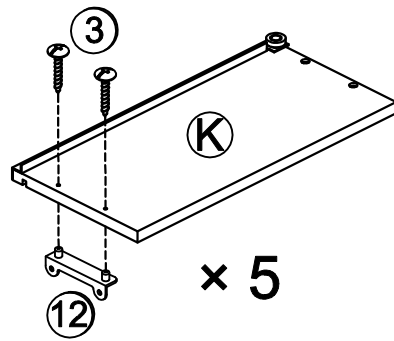
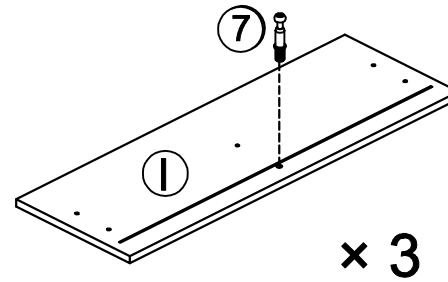
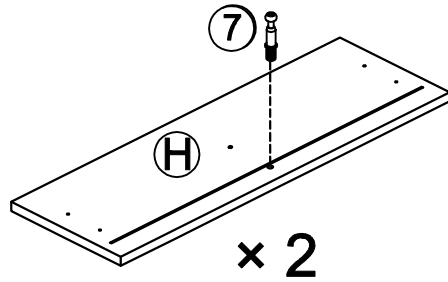
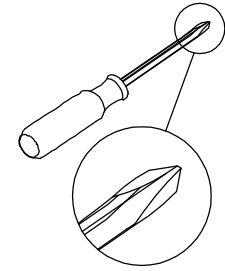
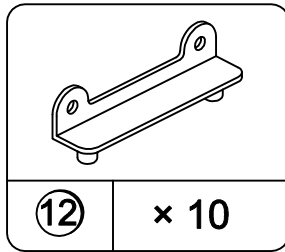
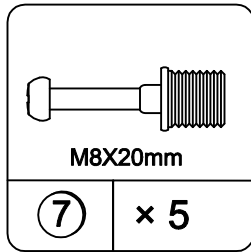
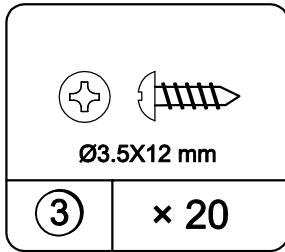

4

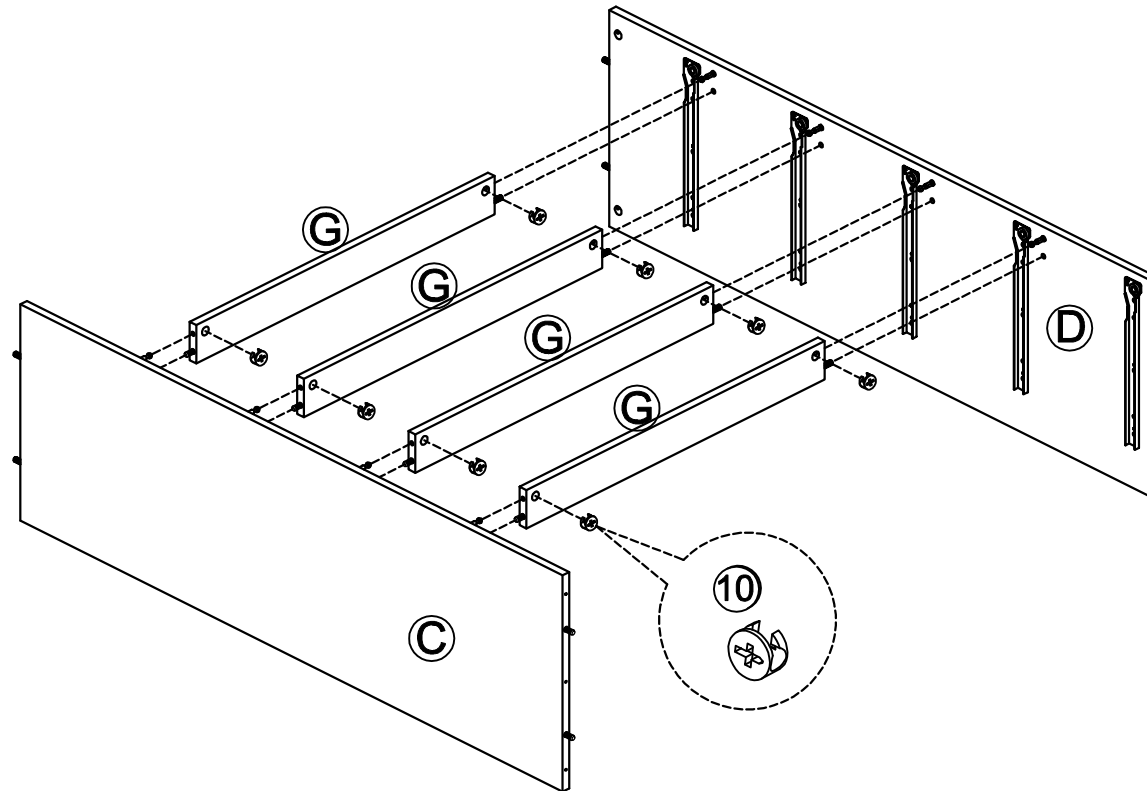
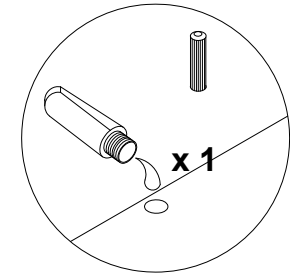
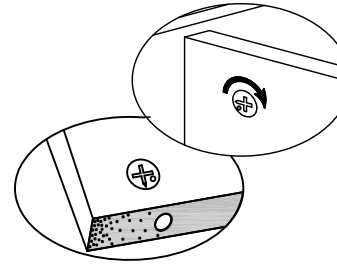
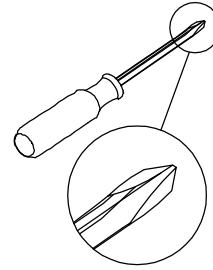
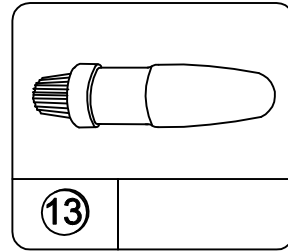
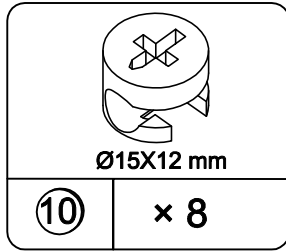

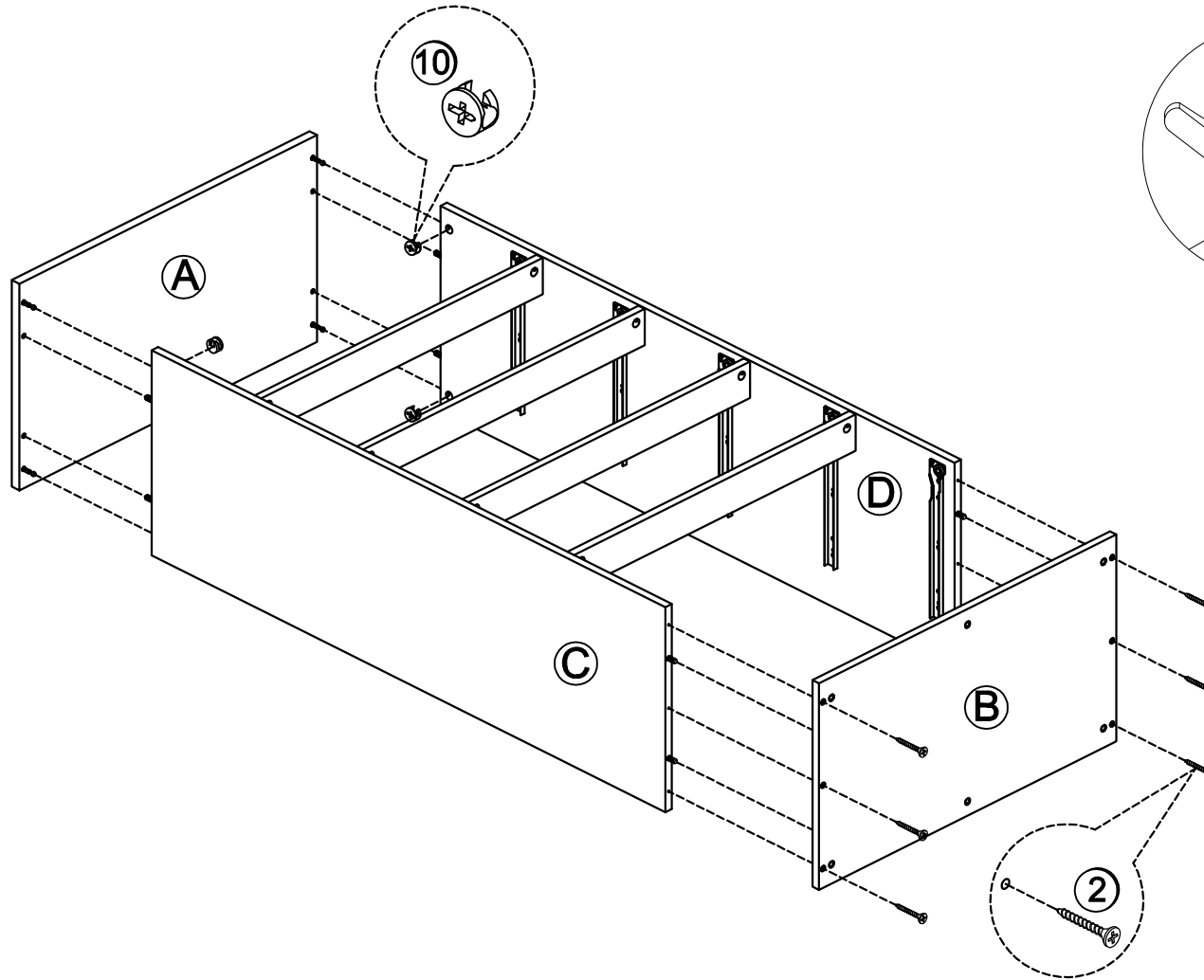
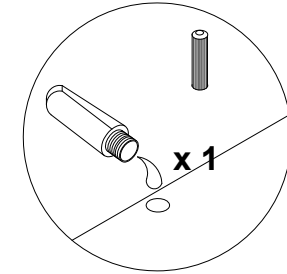
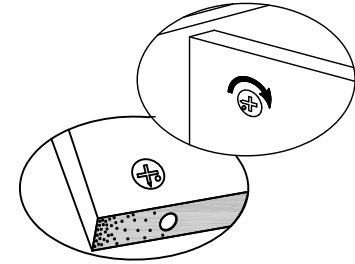
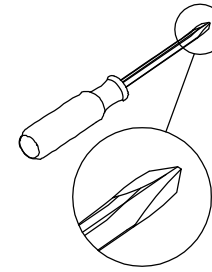
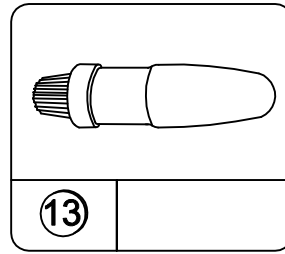
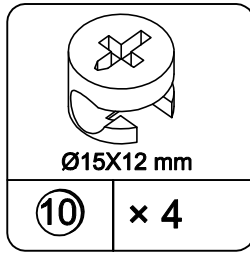
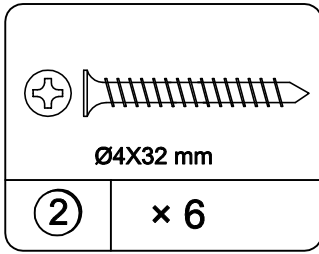

5

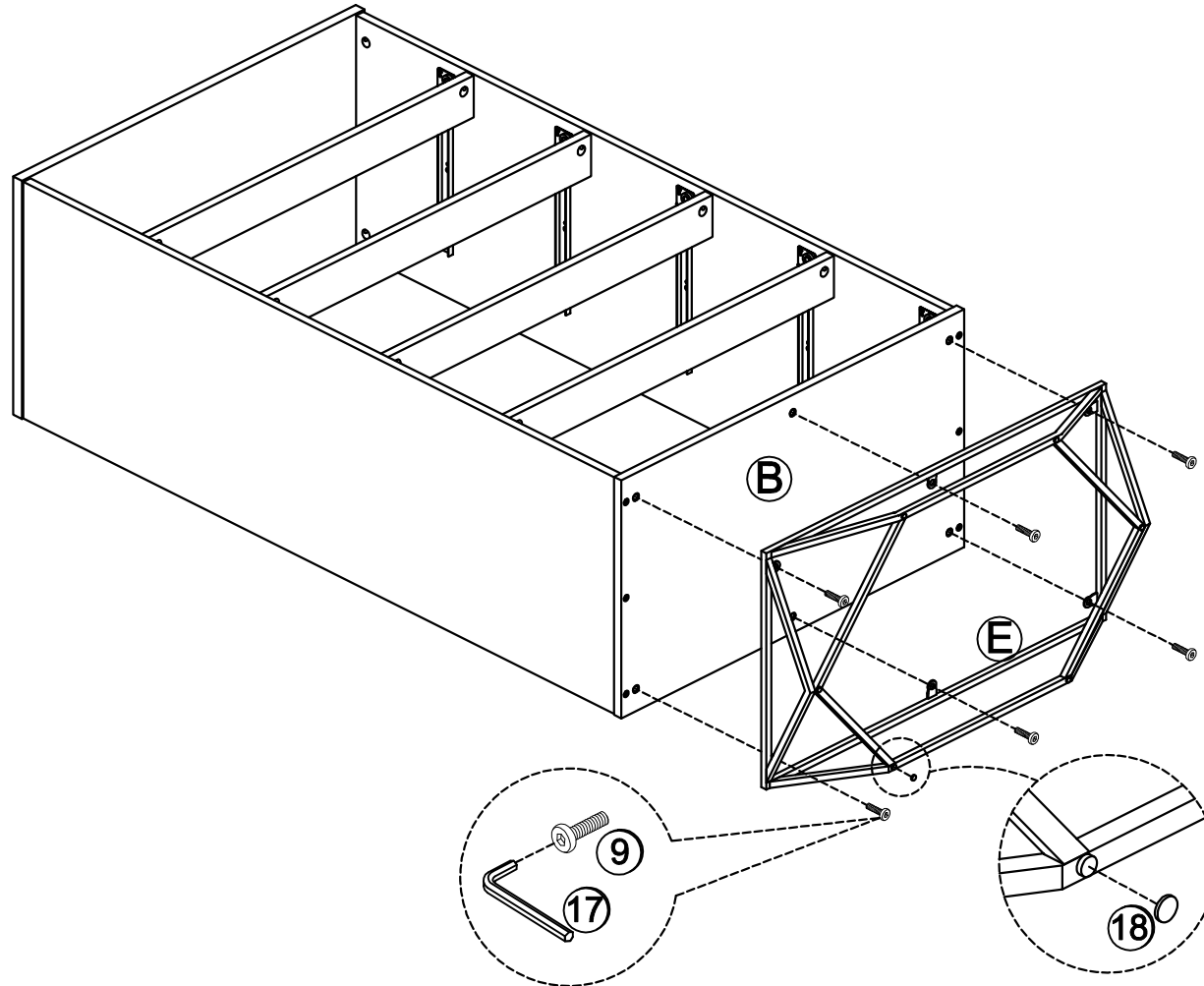
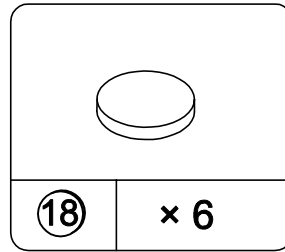
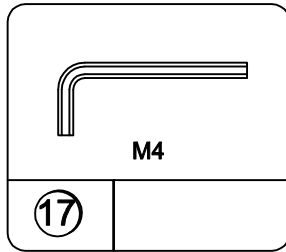
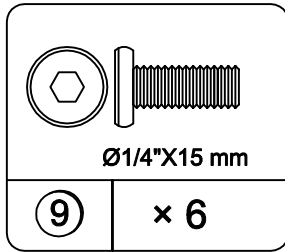

6



7

 	
Ø3.5X12 mm	
④	× 24

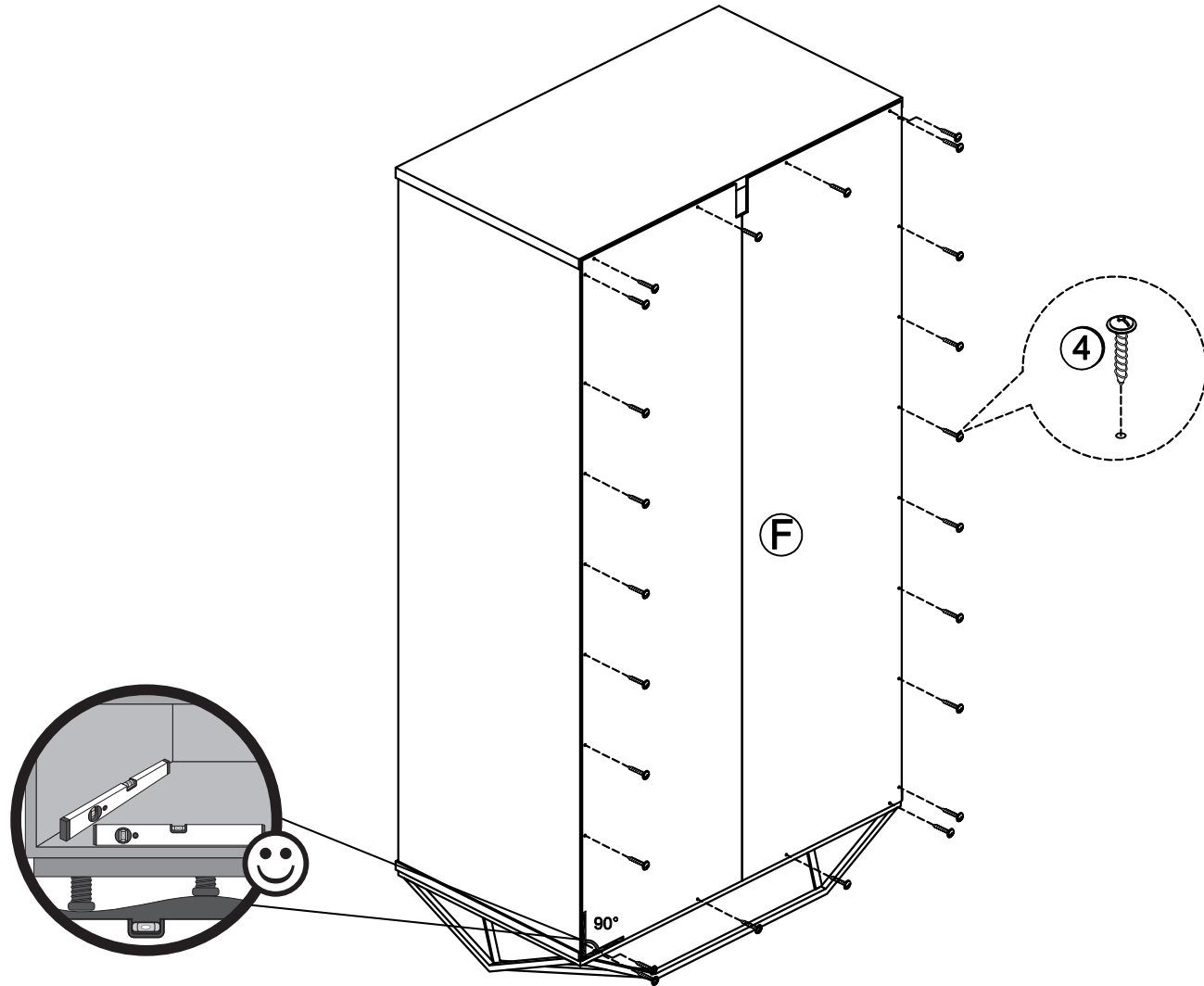
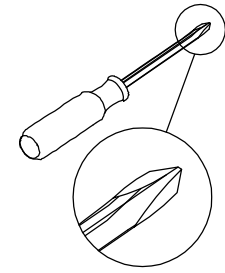

8

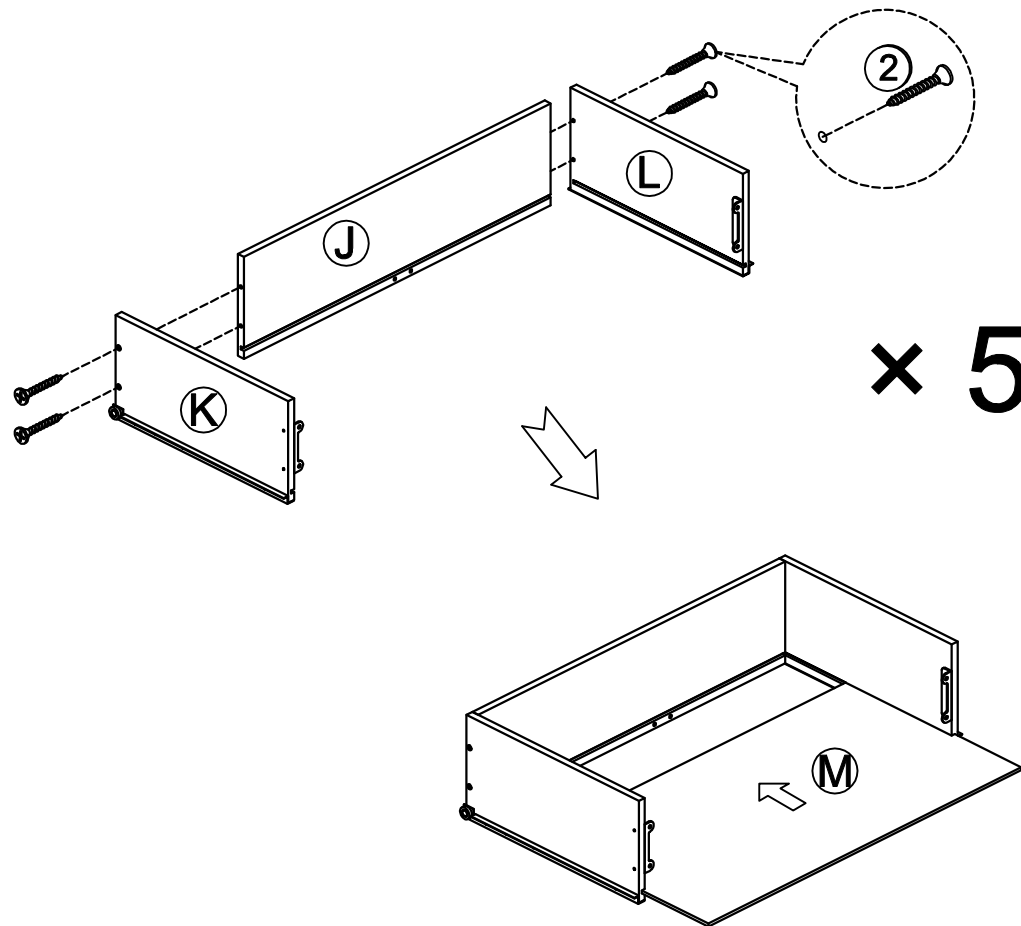
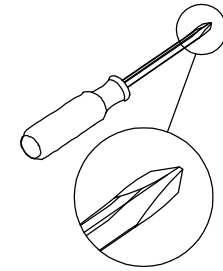
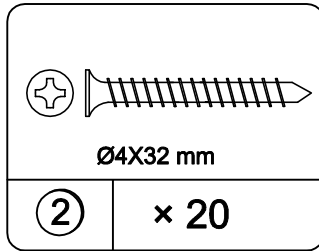

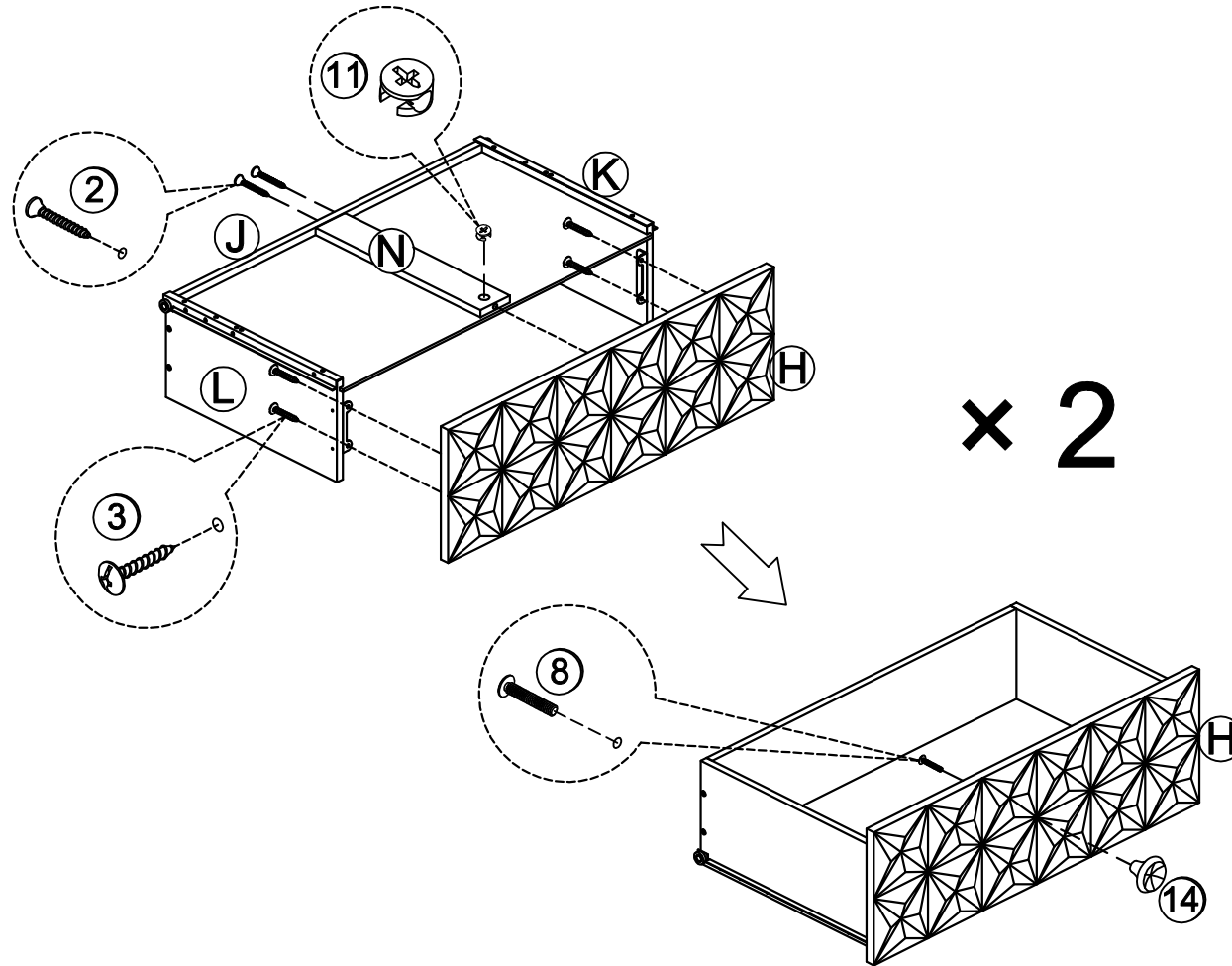
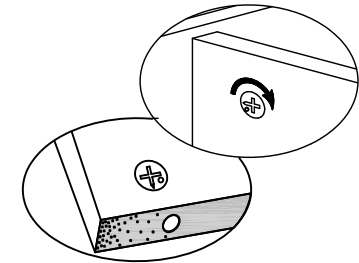
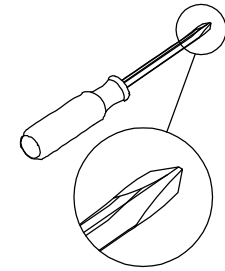
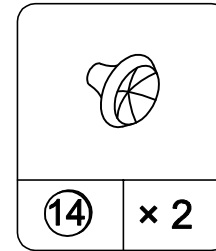
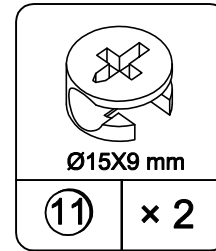
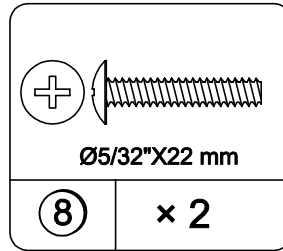
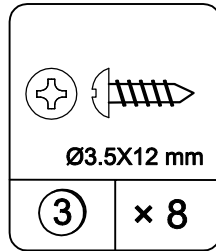
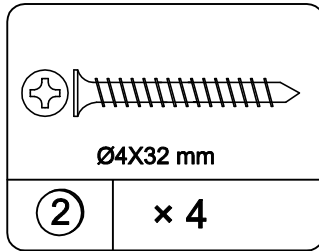

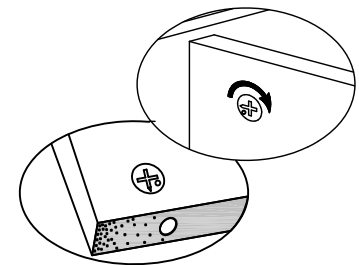
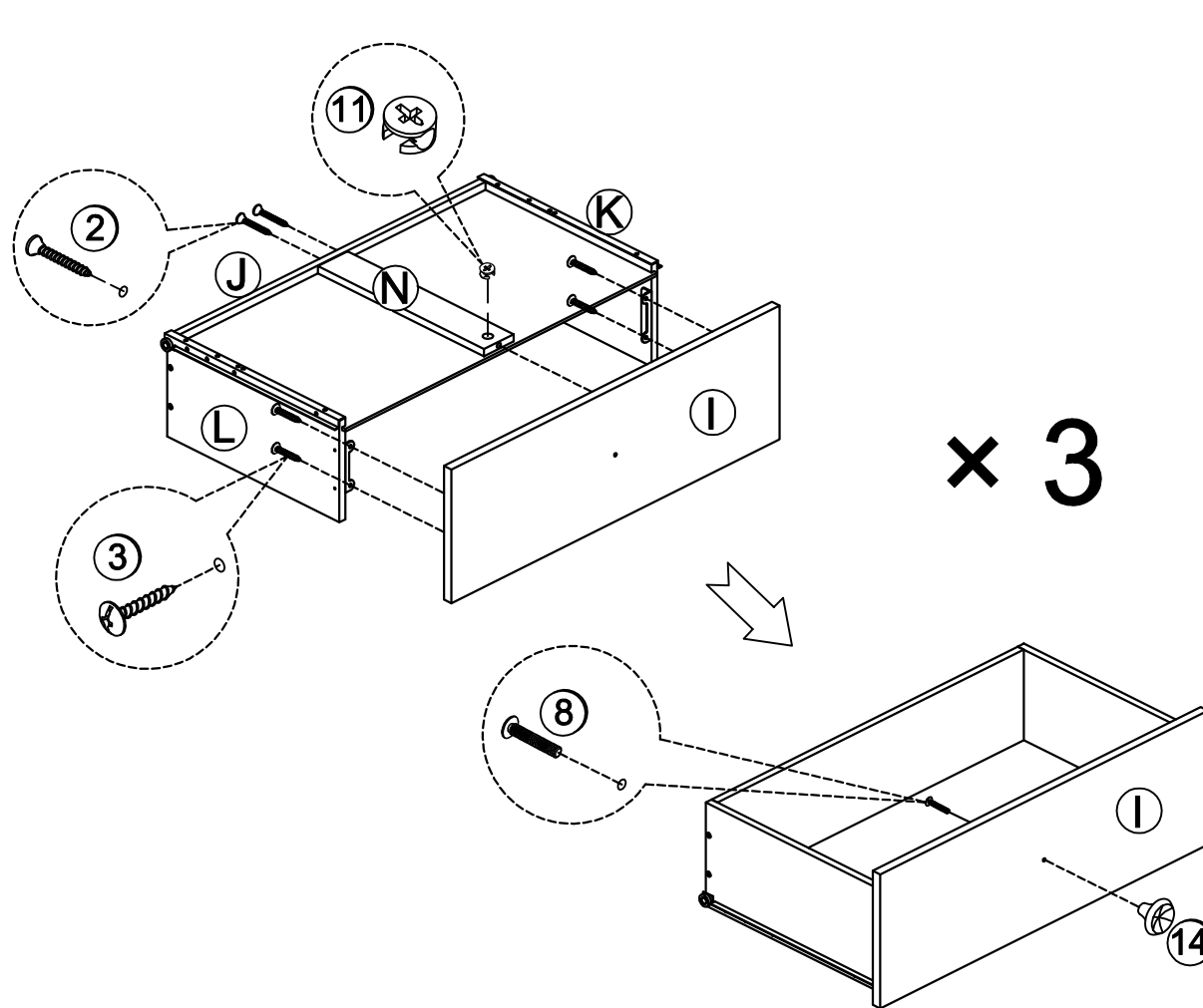
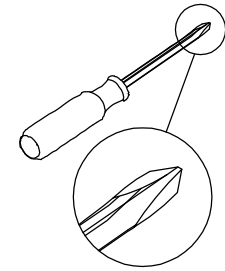
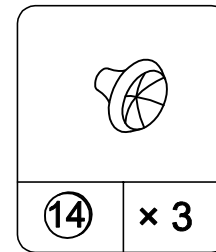
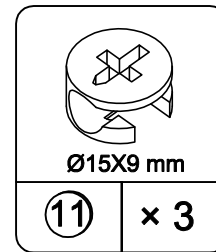
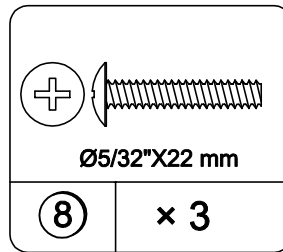
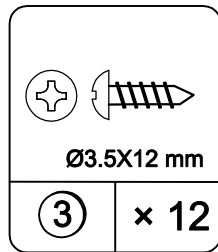
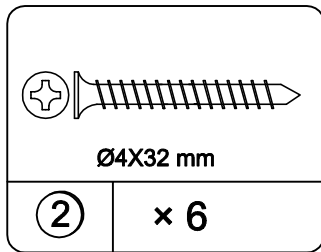

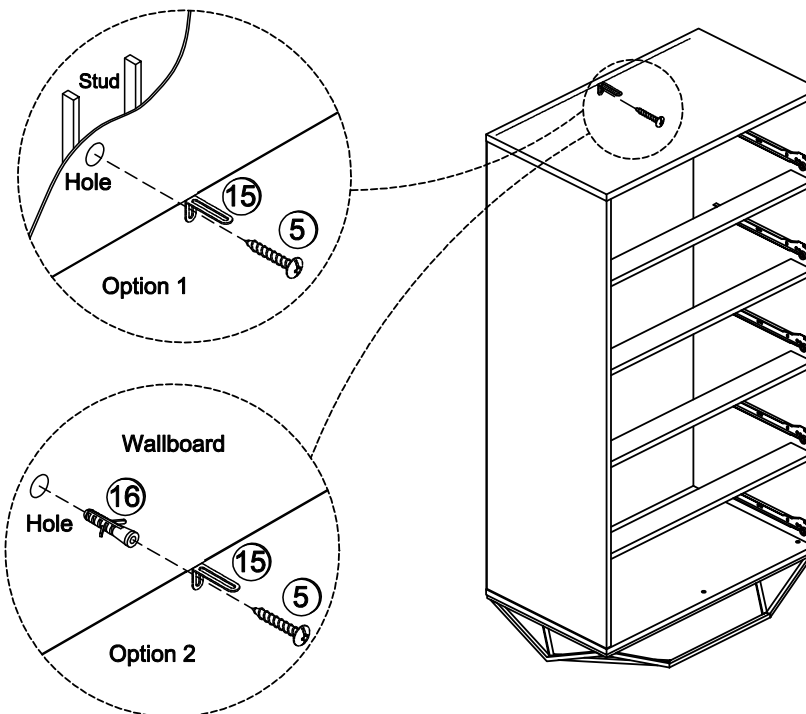
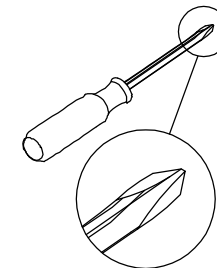
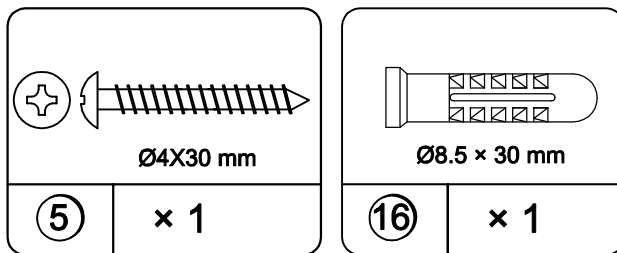

 Achtung • Attention • Attenzione • Opgelet • Uwaga • Pozor • Figyelem Atenție • Dikkat • Внимание 			
D	Wandbefestigung dient als Kippschutz – unbedingt anbringen! Bei einigen Wandtypen kann ein Spezialdübel erforderlich sein!	CZ	Montáž na stěnu slouží jako ochrana proti převrnutí – bezpodmínečně umístěte! U některých typů stěn může být zapotřebí speciální hmoždinka!
GB	The wall fastening serves to prevent tipping – be absolutely sure to mount it! For certain wall types, a special wall plug may be necessary!	SK	Upevnenie na stenu slúži ako ochrana proti prevráteniu – bezpodmienečne použite! Pre niektoré druhy stien môže byť potrebná špeciálna hmoždinka!
FR	La fixation murale sert de protection contre le basculement – à installer impérativement ! Pour certains types de murs il faut des chevilles spéciales !	HU	A terméket a falhoz kel rögzíteni, különben az felborulhat! Egyes faltípusoknál speciális tiplit kell használni!
IT	Il fissaggio alla parete serve da protezione anti-ribaltamento – attaccarla assolutamente! Per alcune strutture di parete può essere necessario un tassello speciale!	RO	Sistemul de fixare la perete servește ca protecție la răsturnare – de montat obligatoriu! Pentru unele tipuri de pereți este posibil să fie necesar un diblu special!
NL	Bevestiging aan de muur dient als kantelbescherming – zeker en vast bevestigen! Bij enkele muurtypes is een speciale plugmisschien vereist!	TR	Duvardaki sabitleme, devrilmeye karşı bir emniyet tedbiridir ve mutlaka monte edilmelidir! Bazı duvar tiplerinde bunun için özel bir dübel gerekli olabilir!
PL	Mocowanie do ściany jest jednocześnie zabezpieczeniem przed przewróceniem – koniecznie zamontować! Do niektórych rodzajów ścian koniecznie zastosować specjalne kołki mocujące.	RU	Обязательно установите крепление на стене во избежание опрокидывания! Для некоторых типов стен может потребоваться специальный дюбель!

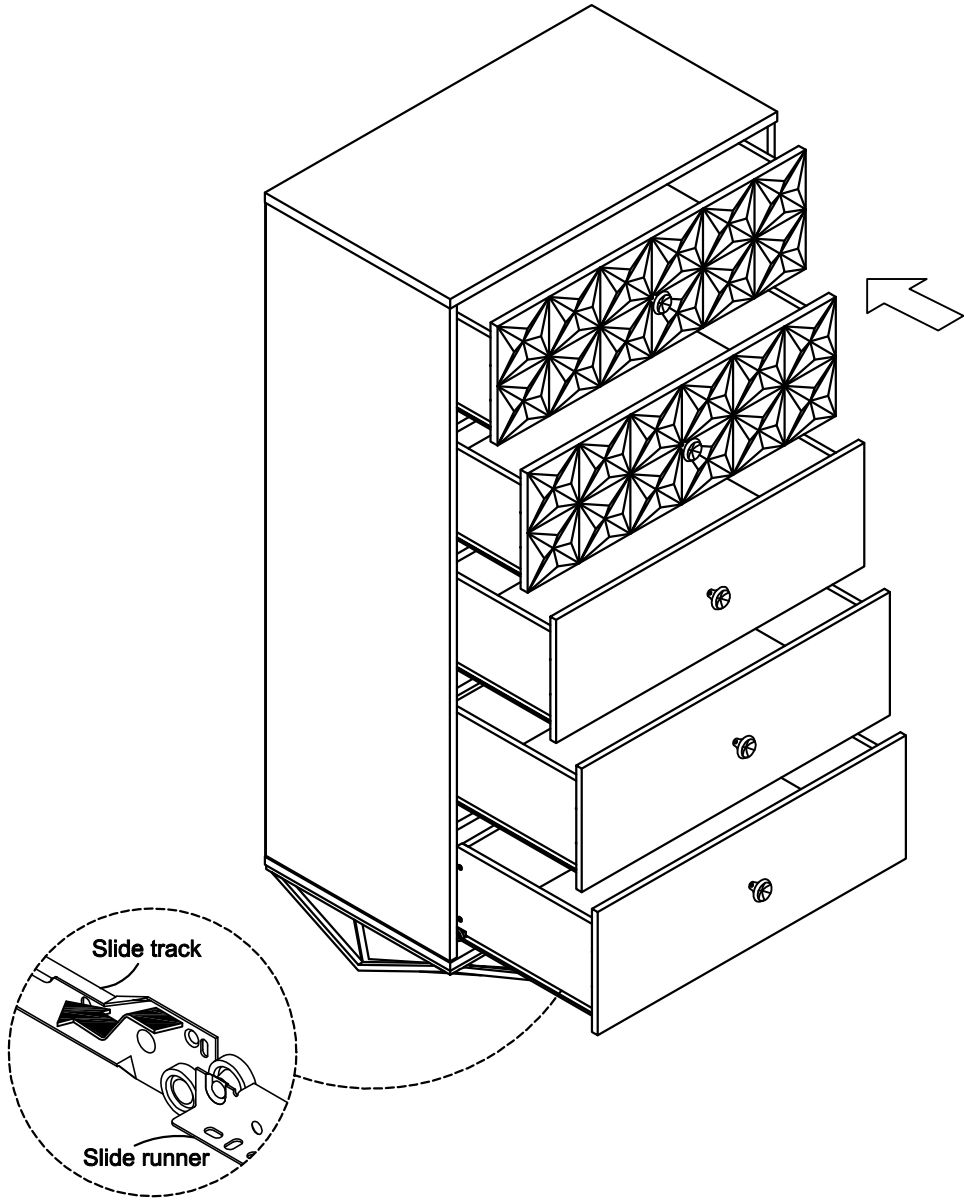

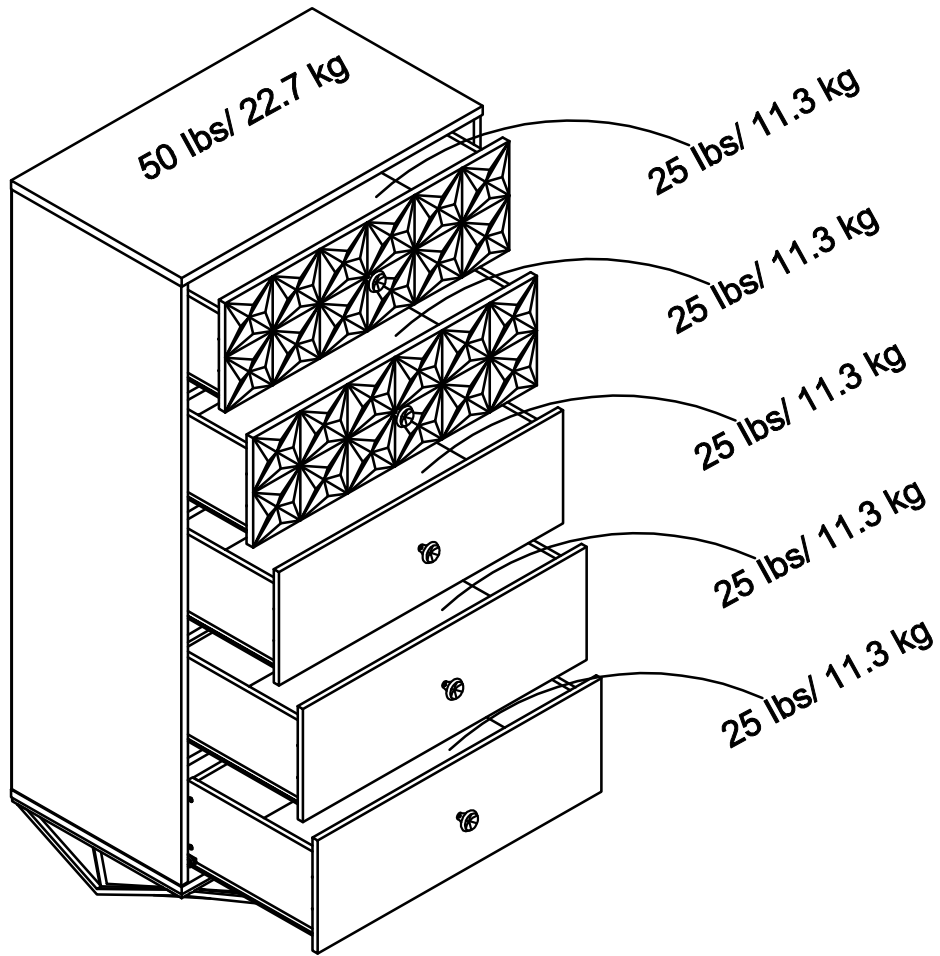



D	Ziehen Sie alle Schrauben sowie tragende Verbindungsteile nach ca. 5 Wochen nach, um eine dauerhafte Standsicherheit zu gewährleisten.
GB	After approx. 5 weeks, tighten all screws and load-bearing connecting parts to ensure permanent stability.
FR	Resserrez toutes les vis ainsi que les pièces de fixation au bout d'environ 5 semaines pour garantir une sécurité de fixation durable.
IT	Ristringere tutte le viti e giunture dopo ca. 5 settimane, al fine di garantire una durevole solidità.
NL	Draai alle schroeven en ook dragende verbindingstukken na ca. 5 weken nog eens vast, zodat een continue stabiliteit wordt gegarandeerd.
PL	Prosimy po ok. 5 tygodniach dokręcić wszystkie śruby w elementach łączeniowych. Zagwarantuje to Państwu trwałość i stabilność połączeń.
CZ	Dotáhněte všechny šrouby a nosné spojovací díly přibližně po 5 týdnech, aby se zaručila trvalá stabilita.
SK	Po cca 4 týždňoch dotiahnite skrutky, aby bola zaručená ich trvalá stabilita.
HU	Húzza utána – kb. 5 hét múlva – az összes csavart és a teherhordó összekötő-alkatrészeket a biztonság érdekében.
RO	Pentru a asigura o stabilitate de durată, strângeți după cca. 5 săptămâni toate șuruburile, precum și toate elementele portante de legătură.
TR	Tüm vida ve taşıyıcı bağlantı parçalarını kalıcı bir duruş güvenliğini sağlamak için yaklaşık 5 hafta sonra tekrar sıkınız.
RU	Подкрутите все болты, а также несущие соединительные детали припл. через 5 недель для обеспечения устойчивости в течение длительного времени.
D	Bitte nur mit einem Staubtuch oder leicht feuchtem Lappen reinigen. Keine scheuernden Putzmittel verwenden.
GB	Please only clean with a duster or a damp cloth. Do not use any abrasive cleaners.
FR	Veuillez nettoyer uniquement avec un chiffon à poussière ou un chiffon légèrement humide. Ne pas utiliser de détergent abrasif.
IT	Si raccomanda di pulire solo con un panno per la polvere o uno strofinaccio umido. Non utilizzare detersivi abrasivi.
NL	Reinig alleen met een stofdoek of een lichtjes vochtige doek. Gebruik geen schurende poetsmiddelen.
PL	Czyszczenie należy wykonać wyłącznie za pomocą ściereczki lub lekko nawilżonego ręcznika. Nie stosować środków czyszczących do szorowania.
CZ	Čistěte prosím jen prachovkou nebo lehce navlhčeným hadrem. Nepoužívejte drhňoucí čisticí prostředky.
SK	Na čistenie používajte len prachovku alebo zľahka navlhčenú utierku. Nepoužívajte žiadne drhňúce čistiace prostriedky.
HU	Kérjük, csak portórlő kendővel vagy enyhén nedves ronggyal tisztítsa. Ne hasznájon dörzsztátású tisztítószert.
RO	Vă rugăm să utilizați la curățare exclusiv o cârpă de șters praful sau o cârpă ușor umezită. Nu utilizați substanțe de curățat abrazive.
TR	Lütfen sadece bir toz beziyle veya hafif nemli yumuşak bir bezle siliniz. Aşındırıcı temizlik malzemeleri kullanmayınız.
RU	Очищайте от пыли тряпкой или слегка влажной ветошью. Не допускается применение чистящих средств, не предназначенных для ухода за мебелью.



D	Überschreiten Sie die angegebenen Maximalbelastungen nicht. Andernfalls kann das Möbelstück beschädigt oder zerstört werden.
GB	Do not exceed the maximum loads specified. Otherwise, the furniture may sustain damage or be irreparably damaged.
FR	Ne dépassez pas les charges maximum indiquées. Sinon, le meuble peut être endommagé ou détruit.
IT	Non superare il carico massimo indicato. Altrimenti il mobile rischia di rovinarsi o frantumarsi.
NL	Overschrijd de aangegeven maximale belastingen niet. Anders kan het meubelstuk worden beschadigd of vernield.
PL	Nie wolno przekraczać podanych maksymalnych wartości obciążenia. W przeciwnym razie mebel może zostać uszkodzony lub zniszczony.
CZ	Nepřekračujte uvedená maximální zatížení. V opačném případě může dojít k poškození nebo zničení nábytku.
SK	Neprekročte uvedené maximálne zaťaženia. V opačnom prípade sa môže nábytok poškodiť alebo zničiť.
HU	Tartsa be az engedélyezett maximális terhelhetőséget/teljesítményt. Különben a bútor és annak alkatrészei megsérülhetnek, tönkre mehetnek.
RO	Nu depășiți solicitările maxime specificate. Altfel puteți să deteriorați sau să distrugeți piesa de mobilier.
TR	Belirtilen azami yük değerini aşmayınız, aksi taktirde mobilya parçası zarar görebilir veya kullanılamaz hale gelebilir.
RU	Не допускается превышение указанных максимальных нагрузок. В противном случае возможно повреждение или разрушение мебели.