

LKZ:80407

Modellname / Model name / Nom du modèle / Modellnamn / Nome modello / Název modelu / Modelnaam / Ime modela / Numéro Modelo / Modell neve / Название модели / Názov modelu / Ime modela / Denumire model / Наименование на модела / Nazwa modelu

ESTEBAN

Modellnummer / Number / Numéro du modèle / Numero / Номер на модела / modello / Číslo modelu / Modell száma / Éíslo modelu / Številka modela / Număr model / Broj modela / Modelnummer / Numer modelu

2312-320-84

Type / Tipo / Típus / Тип / Тип / Tip

320

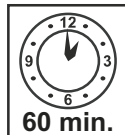
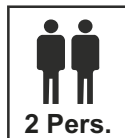
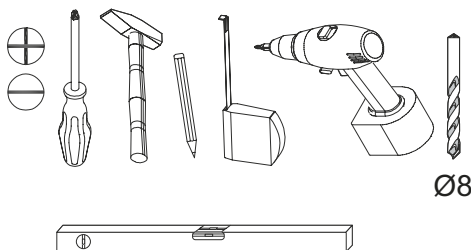
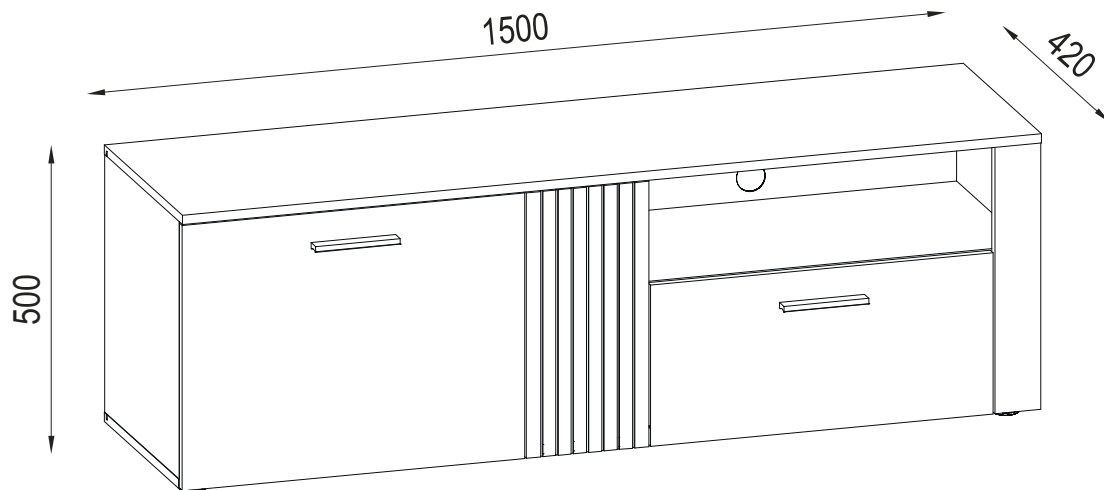
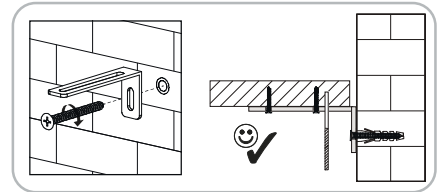
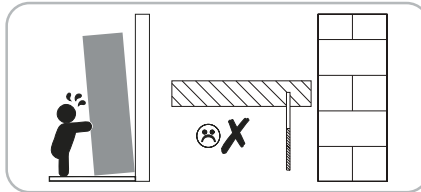
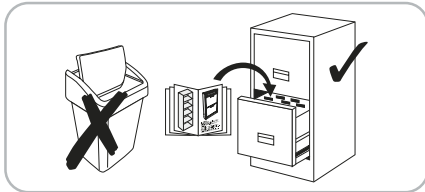
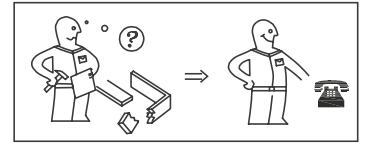
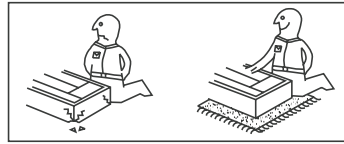
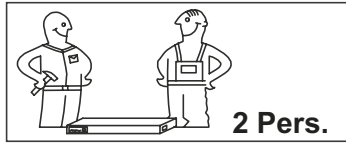
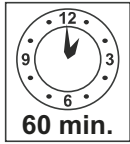

festziehen / tighten / Затянете / serrer / stringere / utáhnout / vasttrekken / zategnuti / strângere / zwiázac / zacisnaç / szorosan meghúzni / pevne dotiahnut / trdno pritegniti / затянуть / dra át



eindrücken / press in / enfoncer / wcisnaç / ribattere / zatlaçit / Вкарайте / indrukken / benyomni / stlaçit / vtišniti / tryck in / introducere prin apăşare / вдавить



ausmessen / measure / mesurer / misurare / opmeten / izmeriti / miara / kimérni / izmeriti / mäsurare / измерить / změřit / Измерете / mät upp / zmierzyc



drücken / press / presser / stisknout / Натиснете / vtišniti / nasinac / drukken / pritisnuti / nacisnac / pritisniti / нажать / (meg)nyomni / apăşare / tryck fast / nacisnaç



einschlagen / hammer in / beverni / slain / frapper au marteau / infossare / Zabit / zarazit / Набийте / zabit / wbiç / introducere prin bătaie / забить / zatlouct



Drehen - wenden / przekreçciç - odwróciç / Keren - omdraaien / Girare - Ruotare / Okrenuti - ubnuti / Retourner - renverser / Turn over - turn around / Otoçte - obratit / Завъртете - обвъртете / Obrnite list / întoarçei - roliçi / Vrid runt - vänd / прокрутить - повернуть / otoçit - obrátit / otoçit - obrátit

LKZ:80407

Modellname / Model name / Nom du modèle / Modellnamn
Nome modello / Název modelu / Modelnaam / Ime modela
Número Modelo / Modell neve / Название модели /
Názov modelu / Ime modelu / Denumire model /
Наименование на модела / Nazwa modelu

ESTEBAN

Modellnummer / Number / Numéro du modèle
Numero / Номер на модела / modello
Číslo modelu / Modell száma / Éíslo modelu
Številka modela / Număr model / Broj modela
Modelnummer / Numer modelu

2312-320-84

Type / Tipo / Típus / Тип / Тип / Tip

320

D

Unser Direktservice für Beschlagteile
Sollte Ihnen ein Beschlagteil fehlen, können Sie diese Servicekarte direkt an die untenstehende Adresse mailen. Wir können allerdings nur Beschlagteile auf diesem Wege verschicken. Sollen Sie eine andere Beanstandung an Ihrem Möbelstück haben, so wenden sie sich bitte direkt an Ihr Möbelhaus.

GB

Our direct order service for fitting
If a fitting part is missing, you can e-mail this service card directly to the address below. However, we can only send fitting parts in this way. If you have any other cause for complaint concerning your item of furniture, please contact your furniture store directly.

CZ

Naše přímé služby pro kování
Chybí-li vám nějaký díl z kování, můžete tuto servisní kartu odeslat e-mailem přímo na níže uvedenou adresu. Touto cestou však můžeme zosílat jen díly kování. Pokud byste reklamovali jiný díl nábytku, obraťte se přímo na svého prodejce nábytku.

F

Bien étudier la notice de montage
S'il vous manque une ferrure, veuillez envoyer directement la présente carte service à l'adresse e-mail indiquée ci-dessous. Cependant, ceci nous permet uniquement d'envoyer des ferrures. Pour tout autre type de réclamation concernant votre meuble, veuillez contacter directement votre magasin d'aménagement.

I

Il nostro servizio diretto per l'ordine della ferramenta
Qualora Vi dovesse mancare un pezzo di fissaggio, allora Vi preghiamo di inviare questa carta di servizio immediatamente all'indirizzo sottostante. Possiamo inviare i pezzi di fissaggio solamente per mezzo di questo procedimento. Qualora dovete avere qualche altra reclamazione in merito al mobile, allora Vi preghiamo di rivolgerVi direttamente al Vostro Negozio di mobili.

BG

Нашата директна услуга за обков
Ако липсват части от комплекта, попълнете настоящата сервисна карта и ни я изпратете на e-mail адреса, посочен по-долу. По този начин можем да доставяме само липсващи елементи от обкова. Ако установите други дефекти по мебелите, Ви съветваме да се обърнете към мебелната къща/магазин, от който сте закупили стоката.

NL

Onze directservice voor losse onderdelen
Wanneer er een onderdeel ontbreekt, kunt u deze servicekaart direct aan onderstaand e-mailadres sturen. Wij kunnen langs deze weg echter alleen beslagdelen versturen. Mocht u een ander probleem aan uw meubel hebben, verzoeken wij u contact op te nemen met uw meubeldealer.

PL

Nasz bezpośredni serwis części montażowych
Jeżeli brakuje części koniecznych do montażu, prosimy o przesłanie nam niniejszej karty serwisowej na niżej podany adres e-mailowy. W ten sposób możemy przelać Państwu tylko brakujące części. W przypadku innych reklamacji dotyczących mebla, prosimy zgłosić się do salonu meblowego, w którym został dokonany zakup.

HR

Servis za okove
U slučaju da nedostaje neki od dijelova molimo vas da na dolje navedenu mail adresu pošaljete ovaj servisni obrazac. Na ovaj način mogu se dostaviti samo okovi. U slučaju da imate dodatne prigovore vezane uz komad namještaja molimo vas da se obratite izravno trgovini namještaja gdje je isti kupljen.

HU

Direktszolgáltatunk vasalatok esetén
Ha hiányzik egy vasalat, ezt a kártyát közvetlenül elküldheti az alább található címre. Azonban csakias vasalatoakat tudunk így küldeni. Amennyiben másfajta reklamációt áll fenn bútorárbát illetően, forduljon közvetlenül a bútorháznál.

SK

Náš priamy servis pre časti kovania
Ak by Vám chýbala nejaká časť kovania, môžete poslať túto servisnú kartu poslať e-mailom na nižšie uvedenú adresu. Diely kovania vieme poslať iba týmto spôsobom. Ak by ste mali inú reklamáciu oľhadom Vašho nábytku, obráťte sa priamo na Vašu predajnú nábytku.

SLO

Naše direktne uslužne storitve za okovje
Ce vam manjka kakšno okovje, lahko to servisno kartico pošljete po e-pošti direktno na spodnji naslov. Po tej poti vam lahko pošljemo samo okovje. Ce želite reklamirati kakšen drug del pohištva, se obrnite neposredno na vašo trgovino pohištva.

RO

Service-ul nostru direct pentru feronerie
În cazul în care vă lipsește o piesă de feronerie puteți să trimiteți direct acest card de service prin e-mail la adresa de mai jos. Noi nu putem expedia piese de feronerie decât pe această cale. Dacă aveți o altă reclamație referitoare la piesa de mobilier, atunci vă rugăm să vă adresați direct la magazinul dvs. de mobilă.

RUS

Наш прямой сервис для поставок фурнитуры
Если окажется, что Вам не хватает того или иного элемента фурнитуры, Вы можете отправить сервисную карту по факсу непосредственно на нижеприведенный адрес электронной почты. Однако, таким образом мы можем пересылать лишь фурнитуру. Если же у Вас возникнут иные претензии относительно приобретенной мебели, пожалуйста, обращайтесь непосредственно в организацию, осуществившую продажу.

S

Vår direktservice för beslagsdelar
Om du saknar en beslagsdel kan du skicka detta servicekort direkt till e-postadressen som anges nedan. Tänk på att detta är den enda möjligheten att skicka beslagsdelar till dig. Om du vill reklamera din möbel av en annan anledning måste du kontakta ditt möbelhus direkt.

ES

Nuestro servicio directo para accesorios
Si le falta algún accesorio, puede enviar esta tarjeta de servicio directamente a la siguiente dirección. No obstante, por este método solo podemos enviar accesorios. Si tiene alguna otra objeción sobre su mueble, consulte directamente con su mueblería.

TR

Donatılar için doğrudan servisimiz
Bir donatınız eksikse bu servis kartını doğrudan aşağıda bulunan adrese doğrudan mail yazabilirsiniz. Sadece bu yolla donatıları gönderebiliriz. Mobilyanızda başka şikayetleriniz varsa lütfen doğrudan mobilya satıcınıza danışın.

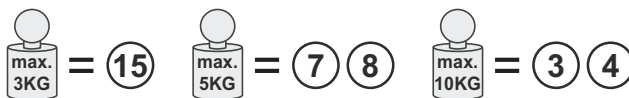
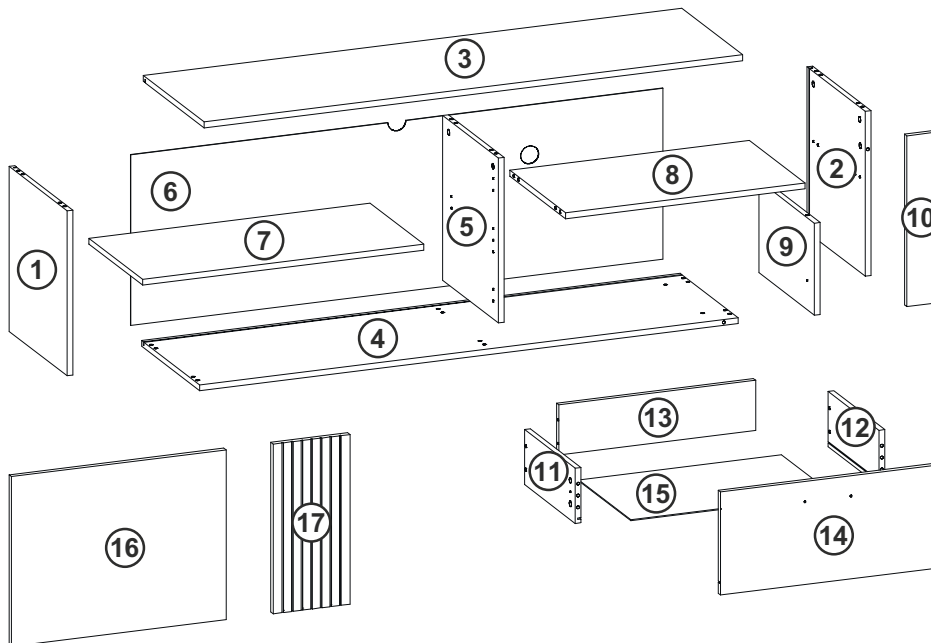

A	B (mm)		C	D
1	448	400	16	x1 1/2
2	448	400	16	x1 1/2
3	1500	420	16	x1 2/2
4	1500	400	16	x1 2/2
5	448	384	16	x1 1/2
6	464	1482	2,5	x1 2/2
7	783	370	16	x1 2/2
8	667	384	16	x1 2/2
9	250	384	16	x1 1/2

A	B (mm)		C	D
10	464	80	16	x1 2/2
11	350	150	16	x1 1/2
12	350	150	16	x1 1/2
13	548	136	16	x1 2/2
14	598	280	16	x1 2/2
15	564	358	2,5	x1 1/2
16	598	461	16	x1 1/2
17	461	214	16	x1 1/2
B1				1/2

Grund der Beanstandung / Cause for complaint:

Möbelhaus / Furniture store:

Kunde/ Customer:

Telefon / Telephone:

PLZ / Postcode:

Ort / City:

Str. +Nr / Street address:

@E-Mail:

LKZ:80407

Modellname / Model name / Nom du modèle / Modellnamn
Nome modello / Název modelu / Modelnaam / Ime modela
Número Modelo / Modell neve / Название модели /
Názov modelu / Ime modela / Denumire model /
Наименование на модела / Nazwa modelu

ESTEBAN

Modellnummer / Number / Numéro du modèle
Numero / Номер на модела / modello
Číslo modelu / Modell száma / Éíslo modelu
Številka modela / Număr model / Broj modela
Modelnummer / Numer modelu

2312-320-84

Type / Tipo / Típus / Тип / Тип / Tip

320

B1 Colli 1/2

A1  **x16**
15x12

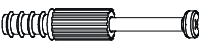
C2  **x16**
44mm

B2  **x22**
8x30

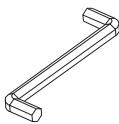
FA1  **x1**
4mm

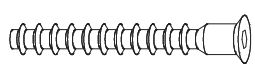
F3  **x10**
6,3x50

O3  **x6**
Ø18

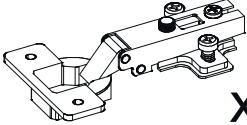
K6  **x4**
Ø35

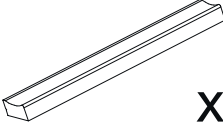
J65  **x2**
128/148

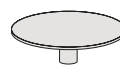
O4  **x5**
Ø18

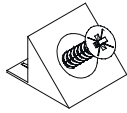
M1  **x10**
10x10x15

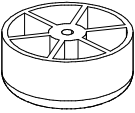
P14  **x5**
45x20

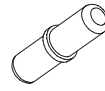
N1  **x4**
Ø6

D25  **x5**
4x25

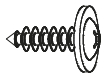
DA21  **x8**
4,2x16

DB2  **x4**
4x25

E5  **x4**
5x11

D11  **x10**
3,5x16

D10  **x4**
3x16

R10  **x2**
Ø10

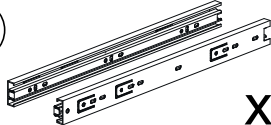
I6  **x1**
350

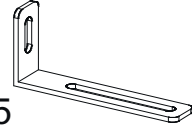
Y36  **x1**
75x32x15

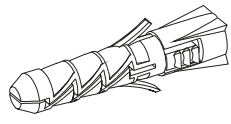
Y37  **x1**
8x50

Y35  **x1**
4,2x65

R6  **x1**

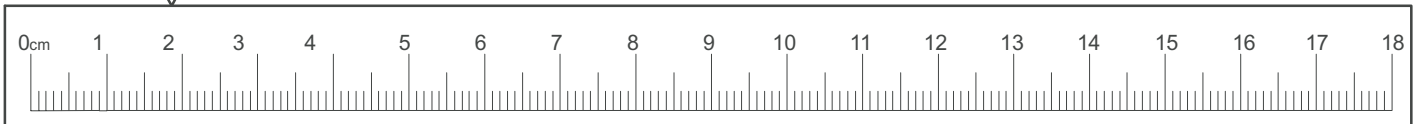
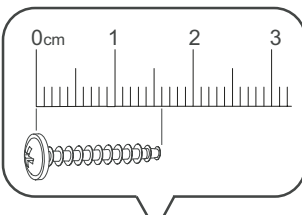

TR

Değerli müşterimiz, evde kullanım için tasarlanan iç mekan programımızdan bir mobilya satın aldığınız için teşekkür ederiz. Lütfen teslimat kapsamının eksiksiz olup olmadığını kontrol edin ve montajdan önce aşağıdaki önemli bilgileri dikkatlice okuyun ve daha sonra üçüncü şahıslar tarafından da kullanılmak üzere saklayın.

Mobilyalarımız amaçlandığı şekilde kullanılmalıdır. Amacı dışında kullanım, maddi hasarlara veya bazı durumlarda kişisel yaralanmalara neden olabilir. Mobilyalar çocuk oyuncakları değildir. Üretici veya satıcı, amaç dışında veya yanlış kullanımdan kaynaklanan hasarlar için hiçbir sorumluluk kabul etmez.

D İ K K A T: Çocuklar veya zihinsel engelli kişiler, yaralanma ve/veya boğulma riski bulunduğundan, mobilya parçalarından, sivri uçlu nesnelere, küçük parçalardan ve ambalaj malzemelerinden daima uzak tutulmalıdır.

M O N T A J: Montaj sırasında lütfen işletim, kullanım, kurulum veya montaj talimatlarınıza uyun ve uyan ve güvenlik talimatlarına özellikle dikkat edin. Talimatlara uymaması, kişisel yaralanmaya veya mobilya hasarına/güvenlik riskine neden olabilir. Montaj / kurulum konusunda zorluk yaşıyorsanız, lütfen servis ekibimize iletişime geçin. Ekibimiz tavsiyeleriyle ve destekleriyle size yardımcı olacaktır. Montaj sadece uzman kişiler tarafından yapılmalıdır. Ürün/ürün parçalarında değişiklikler,

üreticiden/satıcıdan gelmeyen parçalarla/sarf malzemeleriyle değiştirilmesi veya kullanılması durumunda meydana gelebilecek hasarlar için sorumluluk kabul edilmez.

Ürünlere dübel ve vida gibi duvara sabitleme araçları eklenmişse, bunlar sadece sağlam ve tek tip malzemelerden yapılmış duvarlarda kullanılmalıdır. Bir bağlantı sadece bağlantı elemanı ve duvar arasındaki bağlantı kadar iyidir. Lütfen mobilyayı sabitlemeden önce duvarın zemine ayakta hem de asılı mobilya için uygunluğunu kontrol edin ve sadece uygun bağlantı elemanları kullanın. Olası bir delme işleminden önce delme alanında testat olmadığından emin olun. Sonuçta, montaj yapan kişi duvara sabitlemekten sorumludur.

Bu aynı zamanda elektrikli parçaların ve diğer yapısal aksesuarların montajı için de geçerlidir. Elektrikli parçaların ve diğer inşaatla ilgili aksesuarların montaj/kurulumu sadece yetkili uzman personel tarafından yapılabilir. Tüm elektrik ve yapısal kurulumlar, eyaletinizdeki geçerli standartlara ve güvenlik yönetmeliklerine uygun olarak yapılmalıdır. Işık kaynakları için lütfen sadece izin verilen aydınlatma güçlerini kullanın. Maksimum Watt değerine uyulmaması durumunda aşırı ısınma nedeniyle yangın riski söz konusudur. Yangın tehlikesi nedeniyle aydınlatmaların üstünü kapatmak yasaktır.

Mobilyaların düzgün fonksiyonu sadece düz ve yatay konumda garanti edilir. Kapılar önceden ayarlanmıştır, ancak yerel koşullar nedeniyle yeniden hizalanması/ayarlanması gerekebilir. Lütfen maksimum yük ile ilgili ayrıntılarına uyun.

Mobilyaların üzerine çıkılması yasaktır. Yanlış kullanım mobilyaların devrilmesine neden olabilir. Bunu önlemek için mobilyalar her zaman devrilmeye karşı emniyete alınmalıdır. Aşırı yük/aşırı zorlama durumunda (özellikle oyun oynayan çocuklar, insanlar, malzeme veya diğer uygunsuz etkilere nedeniyle) kırılma ve yaralanma riski söz konusudur. Kalıcı sağlamlığı güveneye almak için tüm vidalar ve yük taşıyan bağlantı noktaları 5-6 hafta sonra tekrar sıkılmalıdır.

B A K İ M:
-Mobilya bakımıyla ilgili notlar-
Ürünümüzün keyfini olabildiğince uzun süre çıkarabilmeniz için lütfen uygun mobilya bakımıyla ilgili talimatlarımıza dikkate alın.

Temizlik sırasında temiz, kuru ve yumuşak pamuklu bir bez kullanın. Mobilyanızın kapsamlı bir temizliğe ihtiyacı varsa, bezi biraz su veya mobilya temizleyicisiyle nemlendirebilir ve ardından temizlenen eşyaları kurutabilirsiniz. Metal ve cam parçaları, üzerlerindeki bakım talimatlarına göre piyasada bulunan metal ve cam temizleyicilerle en iyi şekilde temizleyebilirsiniz. Temizlik maddeleri, mobilya temizliği için uygun olduklarını açık bir göstergesini taşımamalıdır.

Hiçbir koşulda buharlı temizleyiciler, kostik, aşındırıcı veya etkilere aşına olmadığınız diğer maddeleri kullanmamalısınız.

D İ K K A T: Çok parlak yüzeyler teslimat sırasında koruyucu bir folyoyla korunur. Bunu tamamen monte edilene ve tozu temizlenene kadar mobilya üzerinde bırakın. Koruyucu folyonun çıkarıldığı çok parlak elementler ancak 72 saat sonra temizlenebilir ve kullanılabilir (ortam havasında son katlaşma süresi). Yüzeylere keskin nesnelere zarar vermeyin ve asla güçlü güneş ışığına maruz bırakmayın.

T A S F İ Y E
-Tasfiyeyle ilgili notlar-
Çevre için lütfen türüne göre ayrılmış ambalaj atıklarını doğaya değil, bunlar için sağlanan atık/geri dönüşüm kutularında tasfiye edin.

Hasarlı veya kullanılmayan mobilyalar, her bir parçanın geri dönüştürülmesi için özel geri kazanım tesislerine gönderilebilir.

Artık kullanılmayan ancak hala işlevsel olan mobilyaların hemen tasfiye edilmesi gerekmez. Bunları örneğin hayır kurumlarına bağışlayın.

Yeni mobilyalarınızı güle güle kullanın.

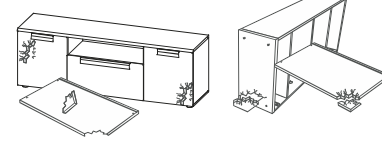
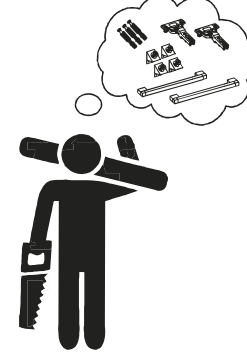
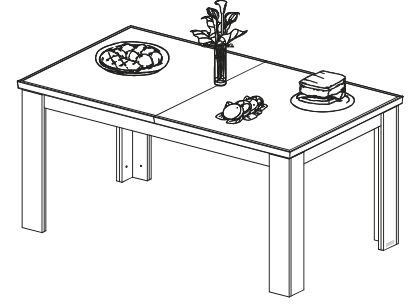
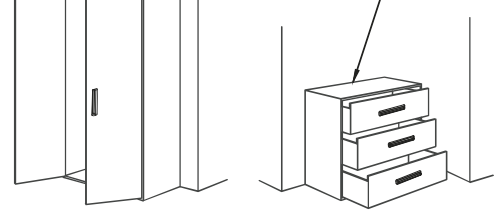
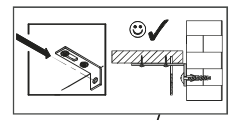
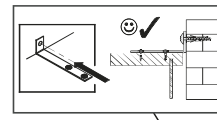
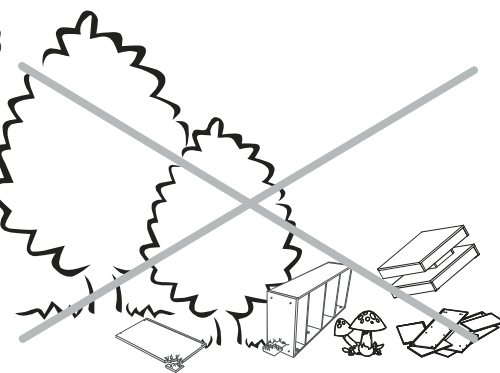
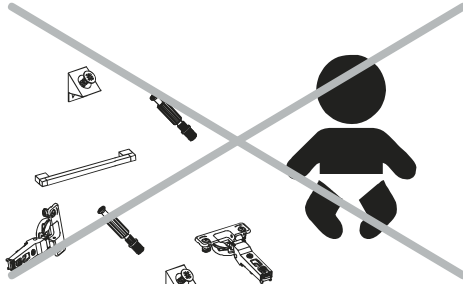
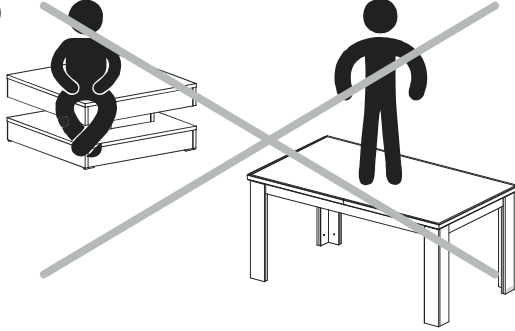
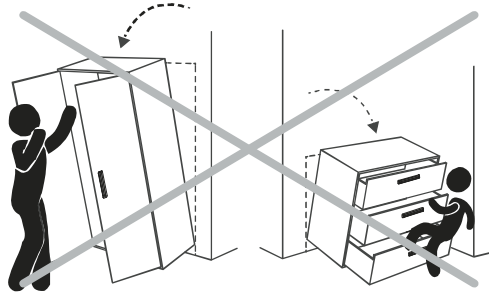

1

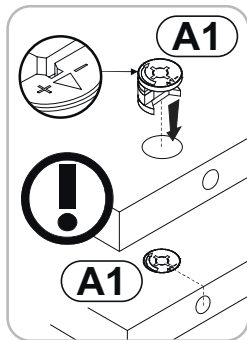
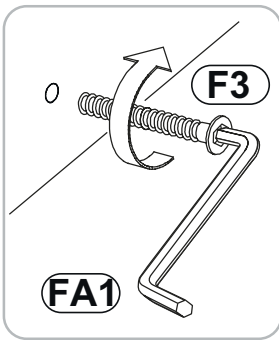
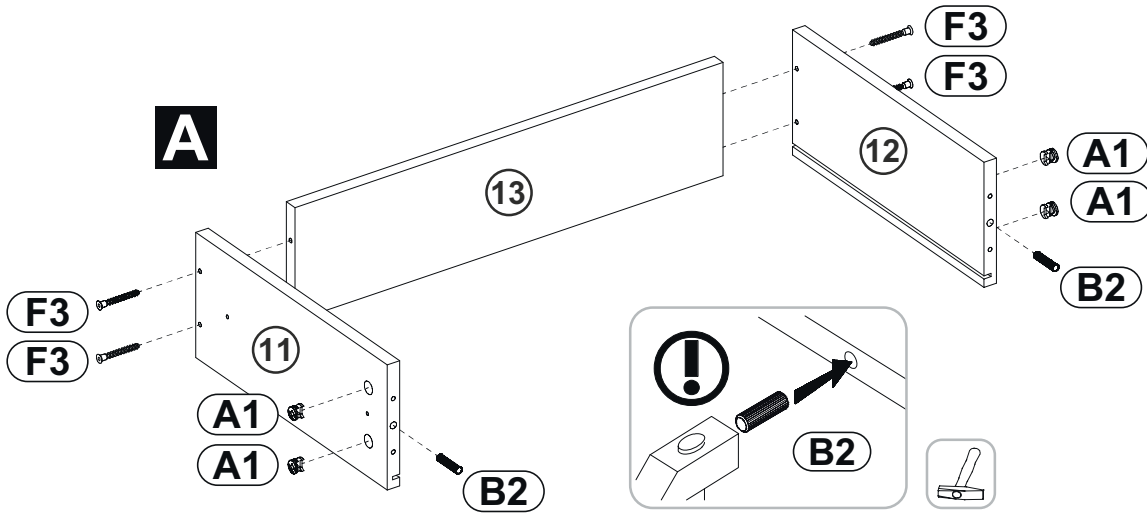
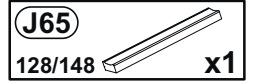
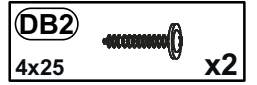
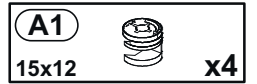
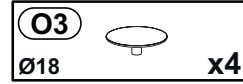
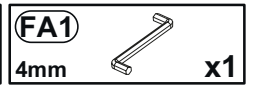
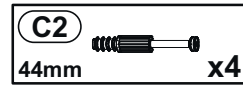
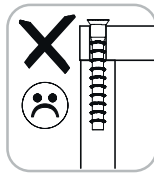
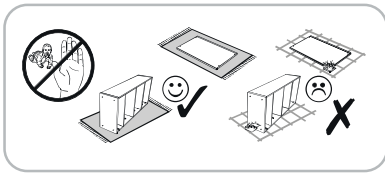

B

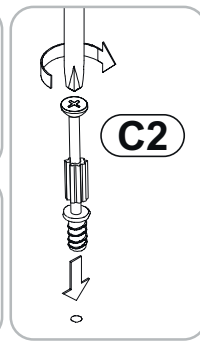
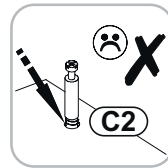
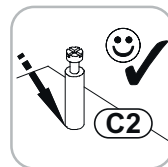
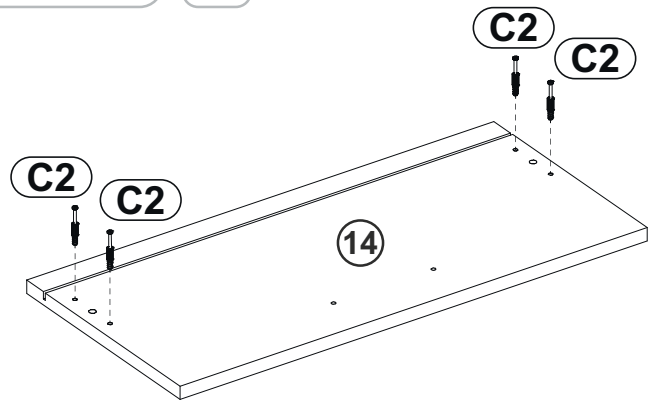

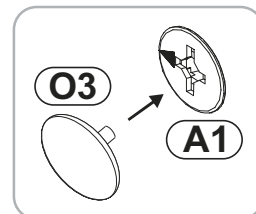
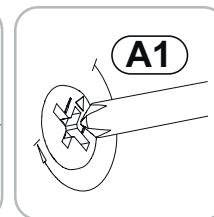
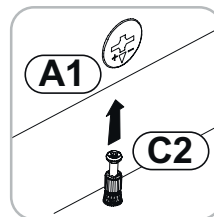
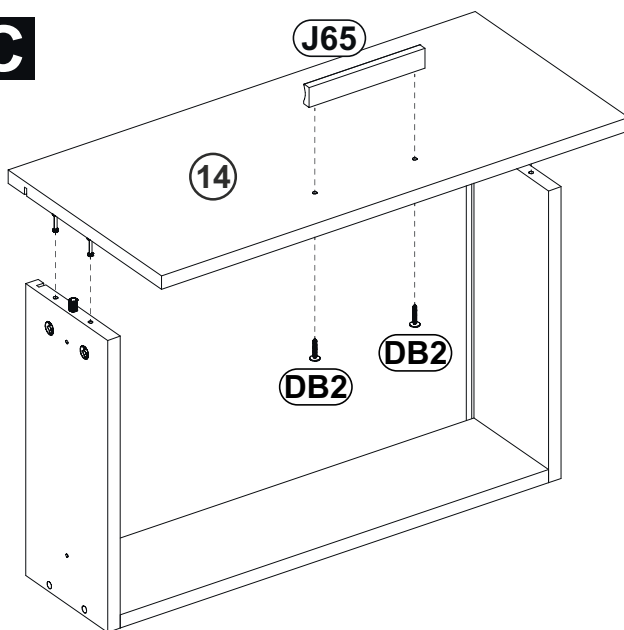

C

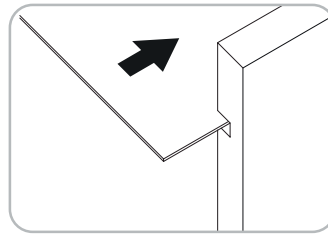
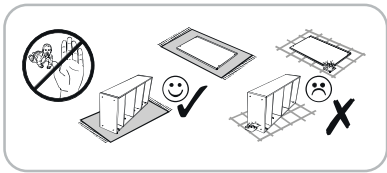

2

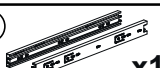

- DA21** 4,2x16  x4
- I6** 350  x1
- D10** 3,0x16  x4

D

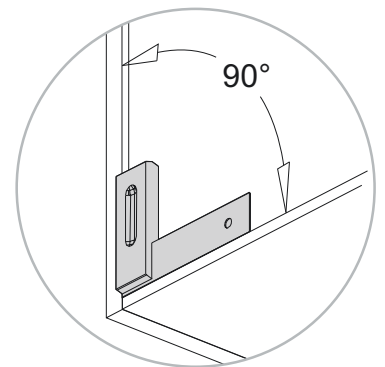
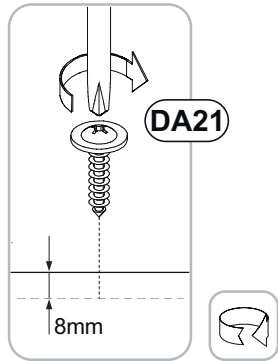
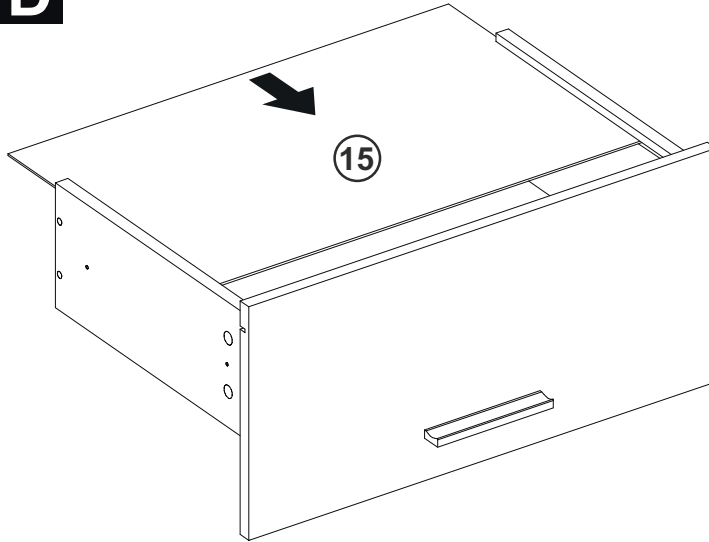



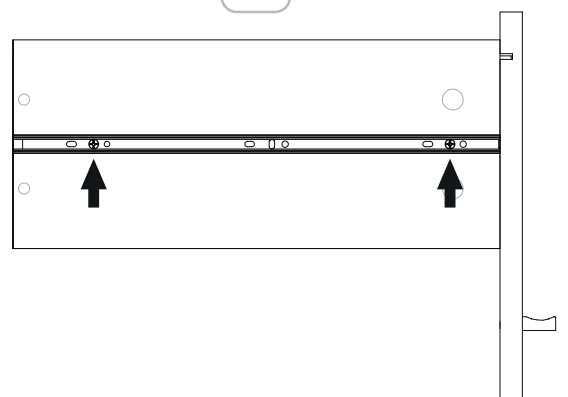
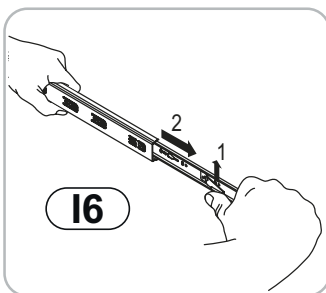
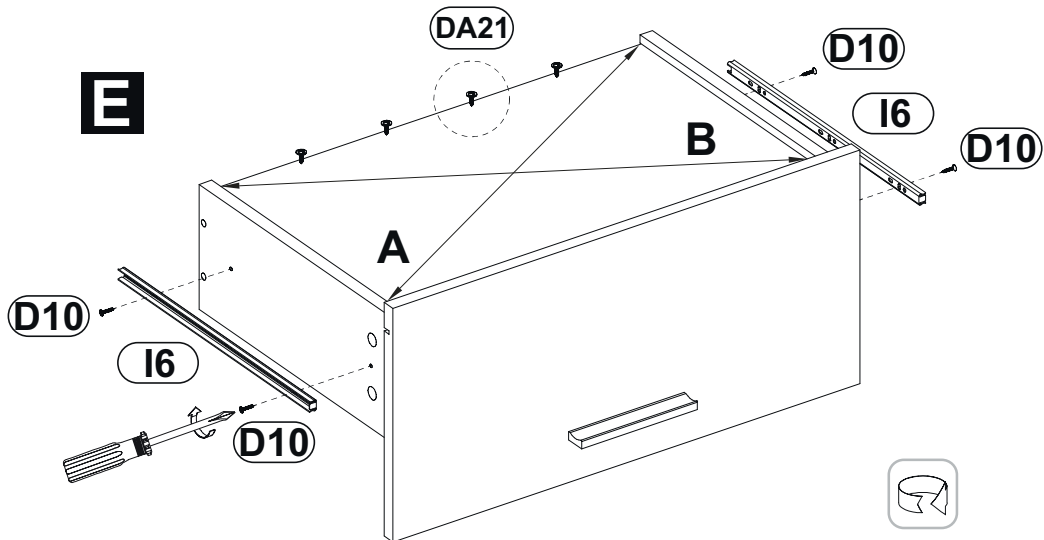

A=B

E

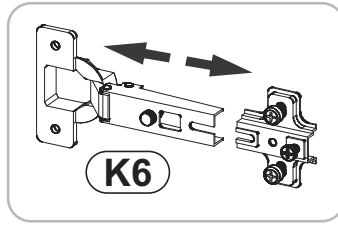
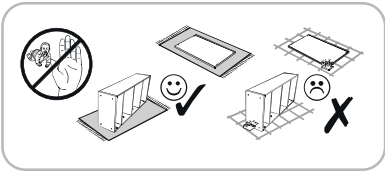

3

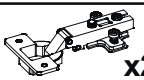



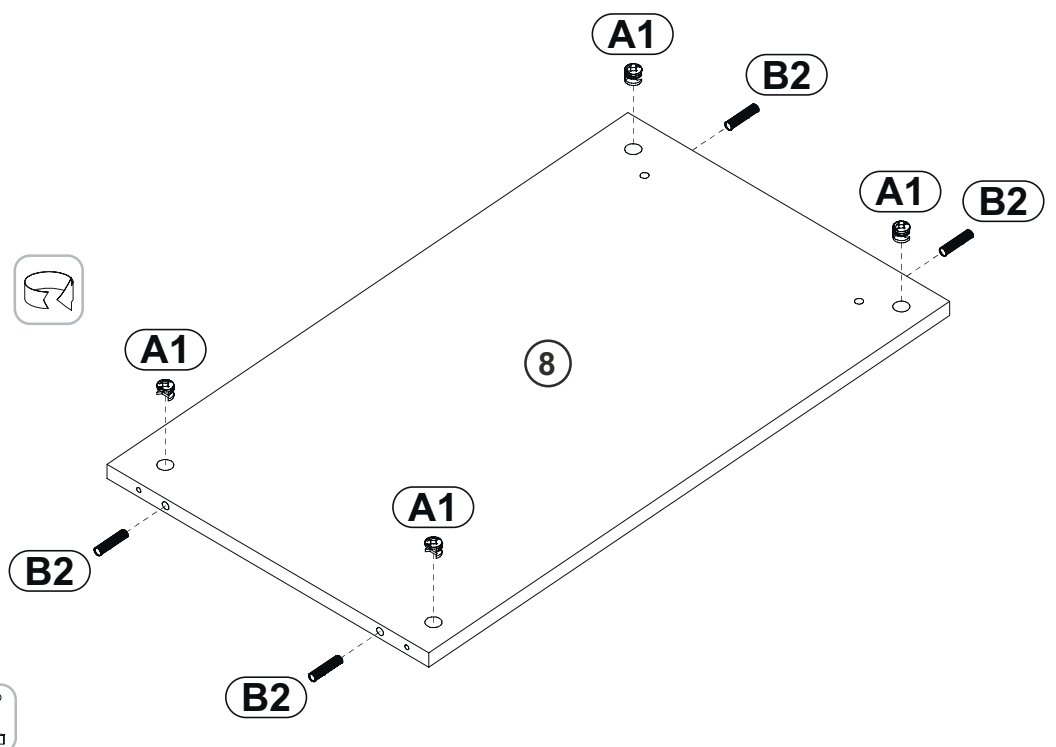
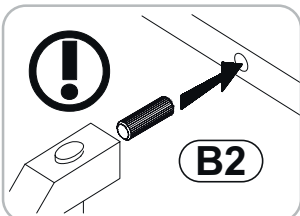
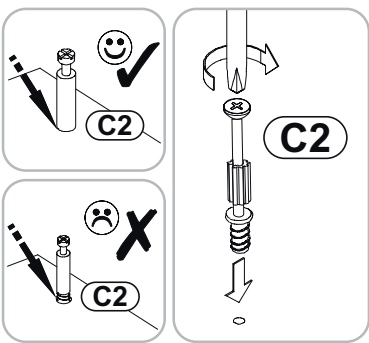
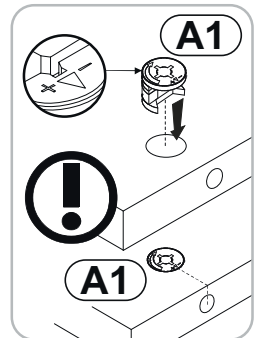
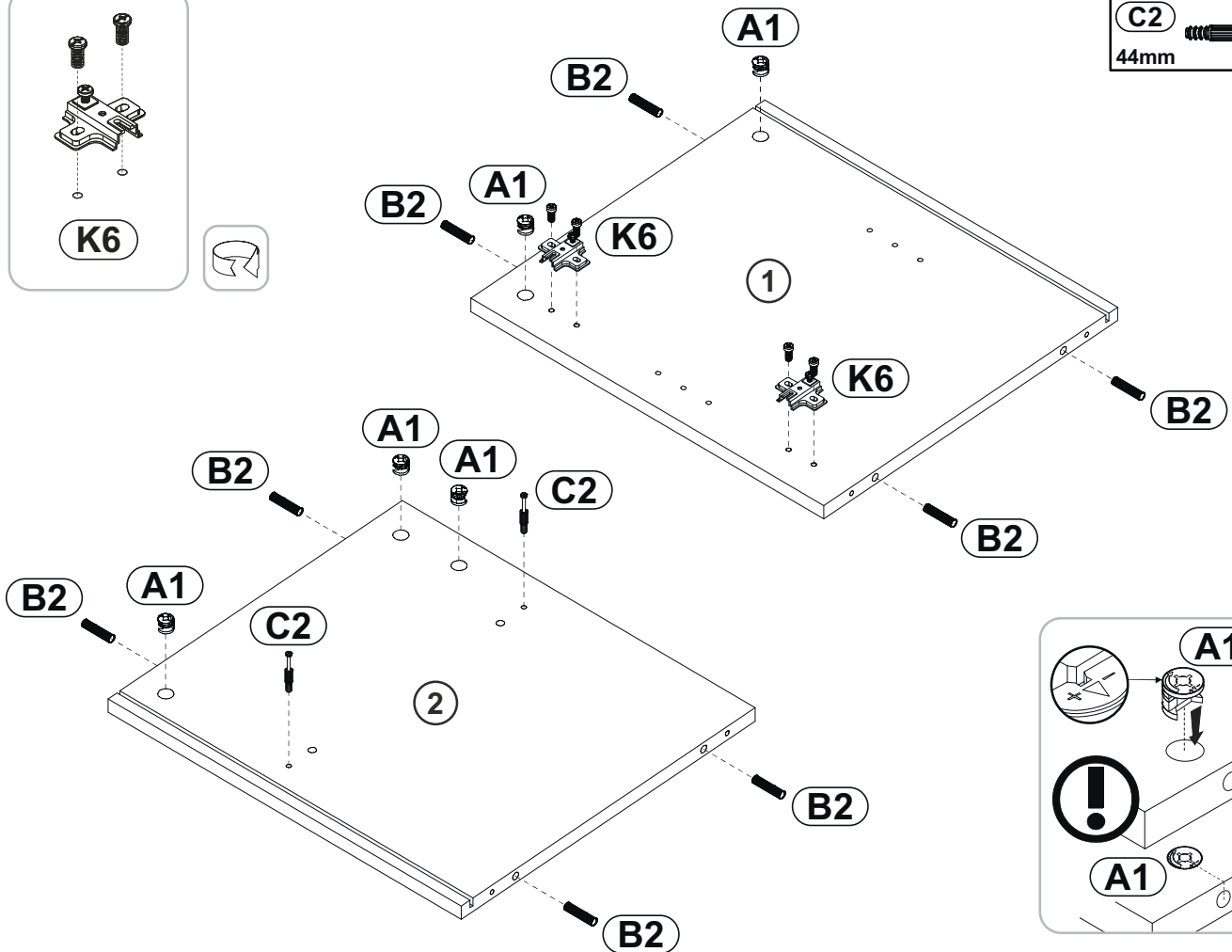
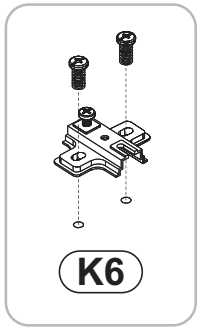

- A1** 15x12  x9
- B2** 8x30  x12
- K6** Ø35  x2
- C2** 44mm  x2

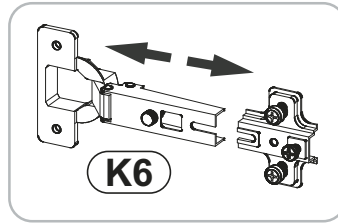
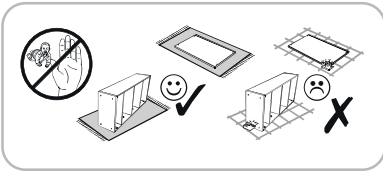

4

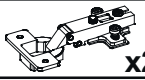

- A1** 15x12  x2
- C2** 44mm  x2
- B2** 8x30  x8
- K6**  x2
- I6** 350  x1
- E5** 5x11  x4

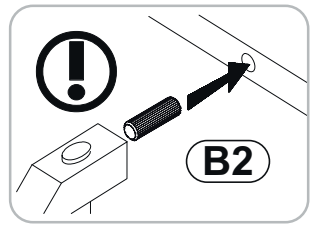
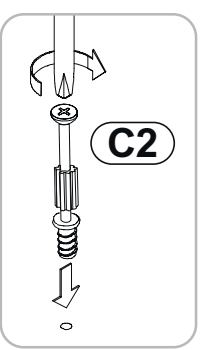
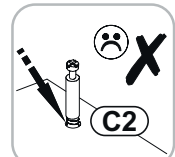
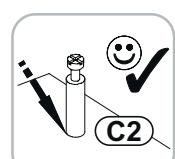
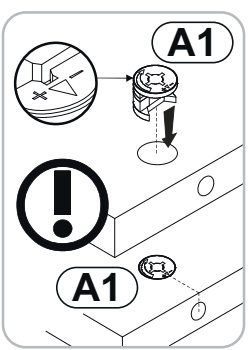
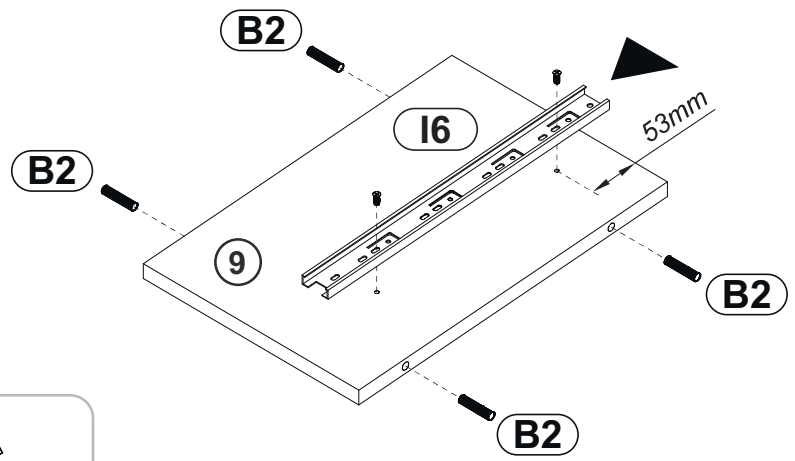
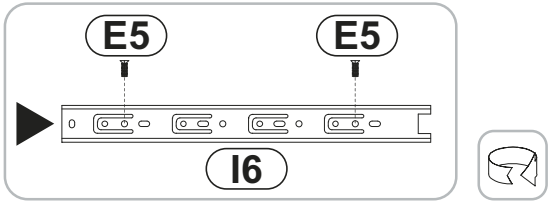
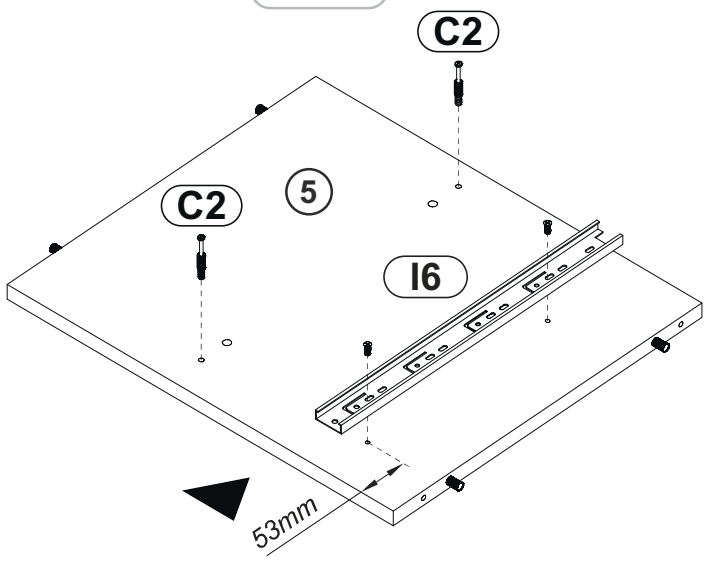
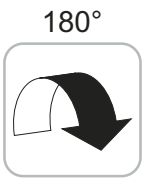
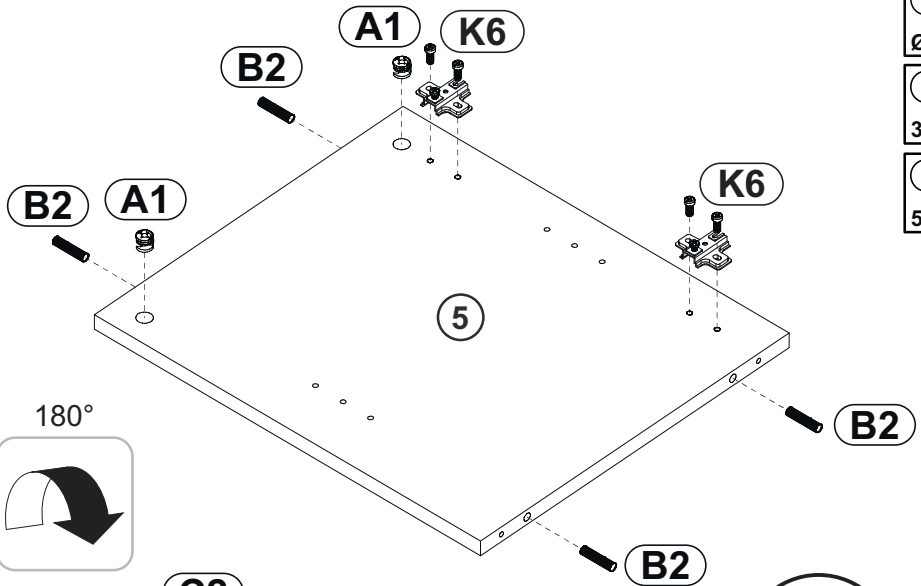
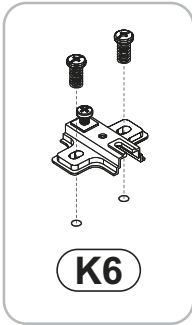

5

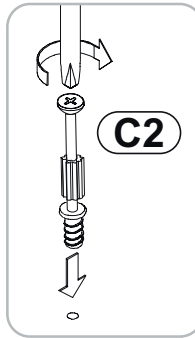
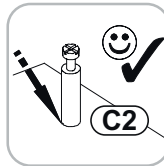
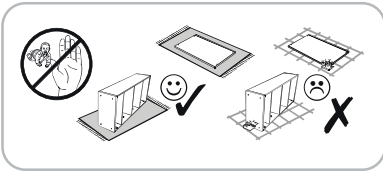

- C2** 44mm x8
- A1** 15x12 x1
- Y36** 75x32x15 x1
- D11** 3,5x16 x2

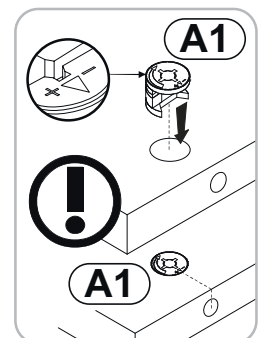
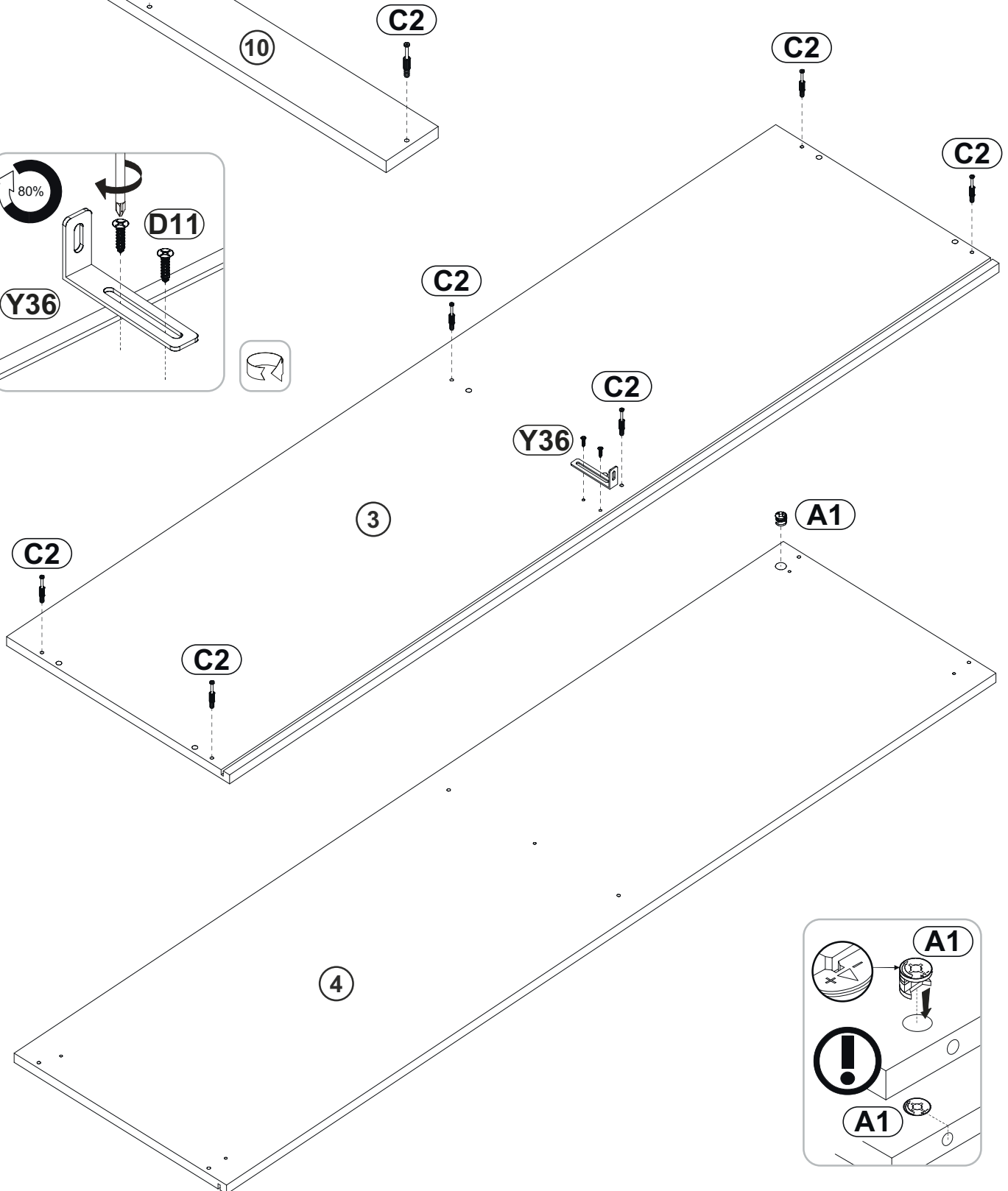
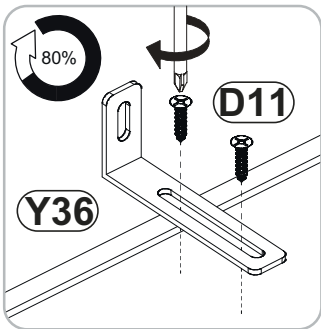
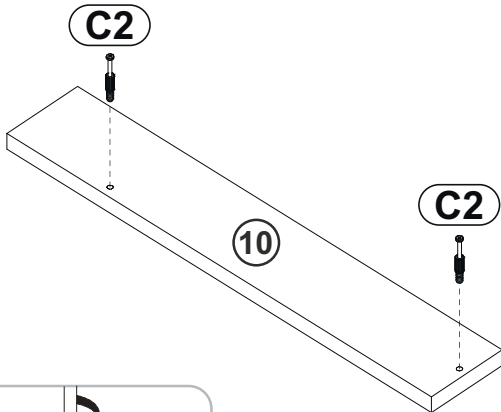

6

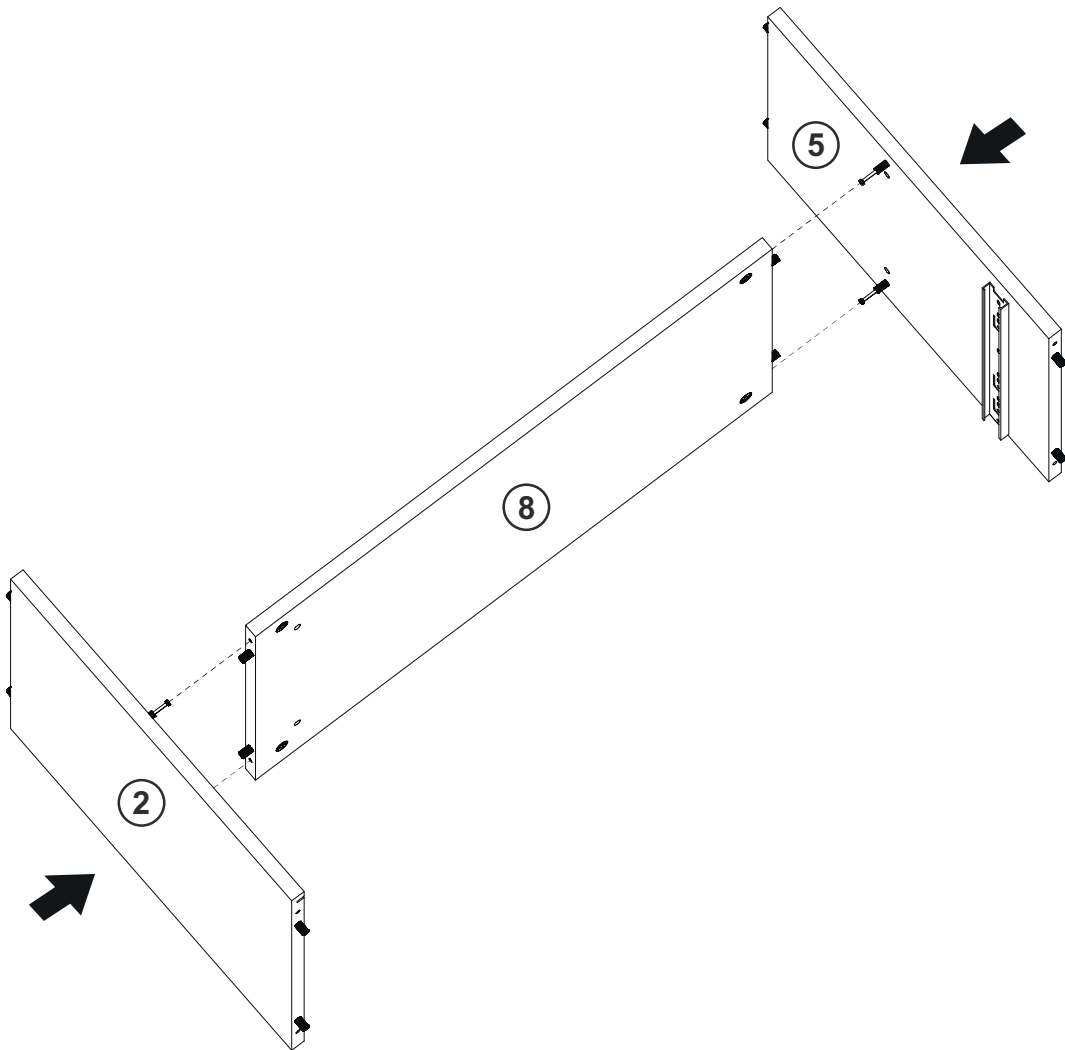
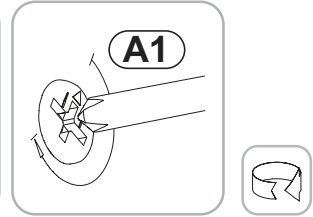
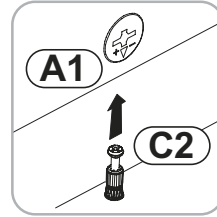
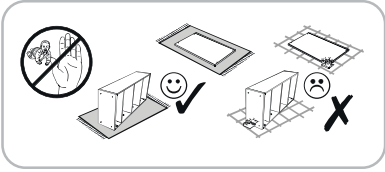

7

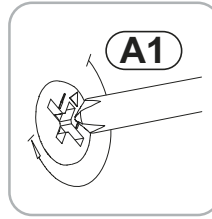
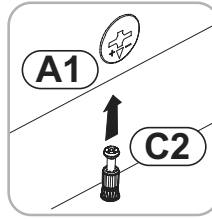
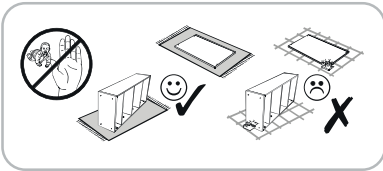

O4
Ø18 x4

O3
Ø18 x2

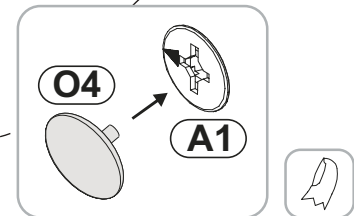
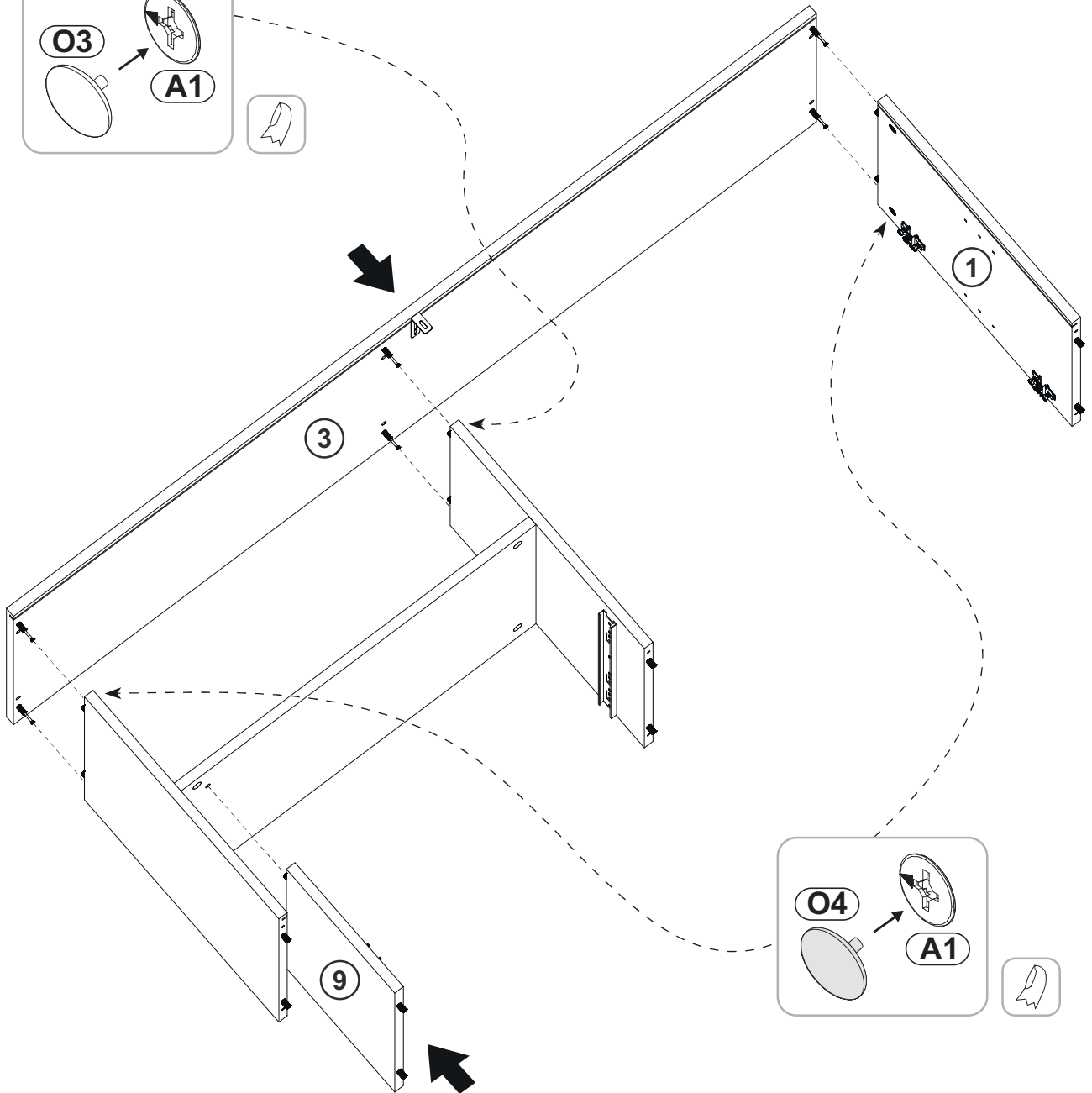
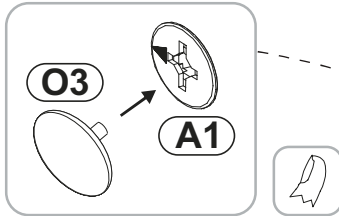

8

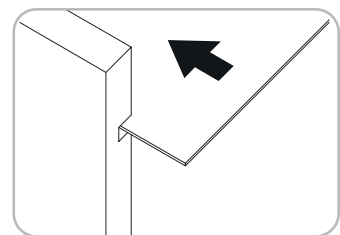
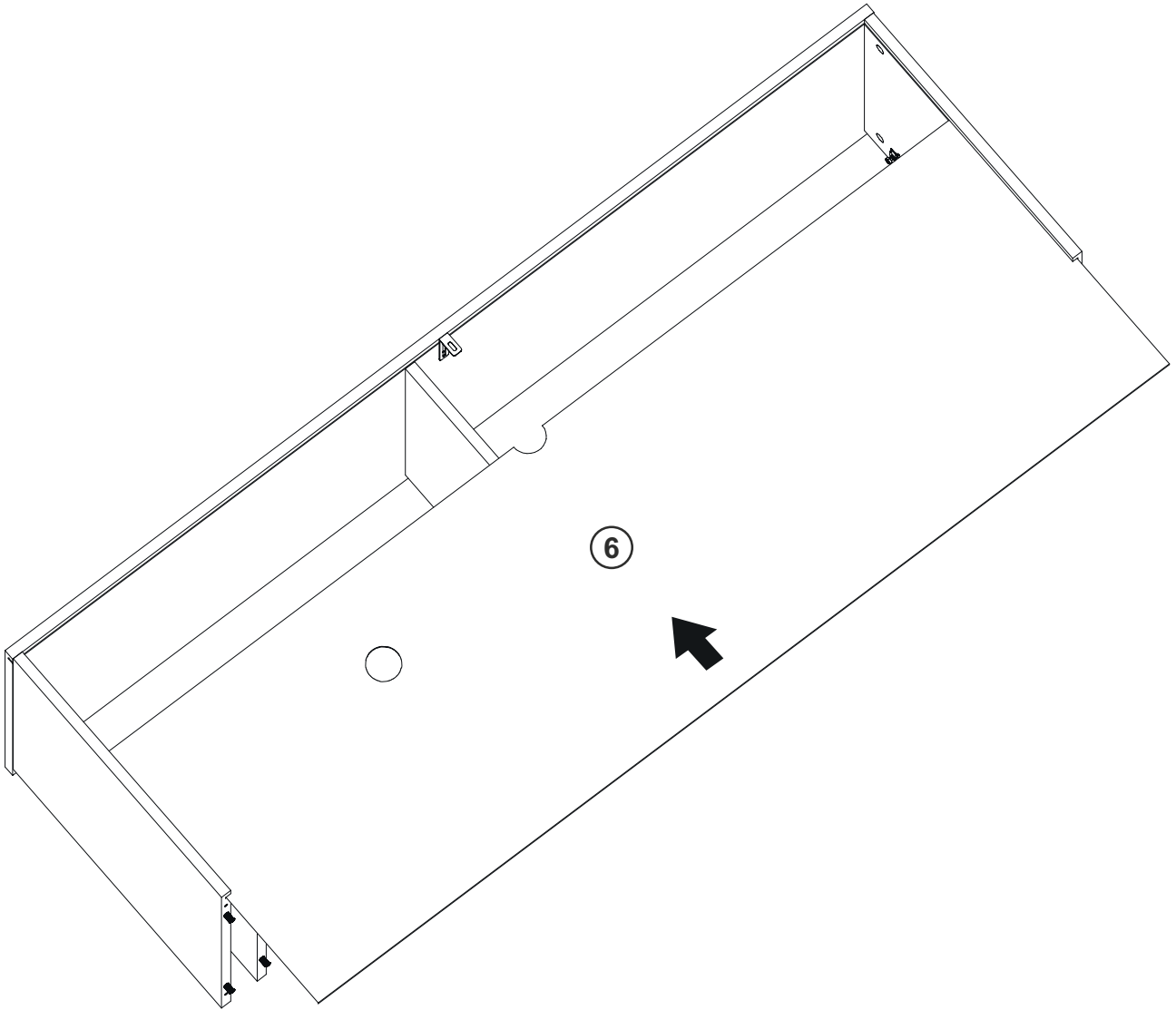
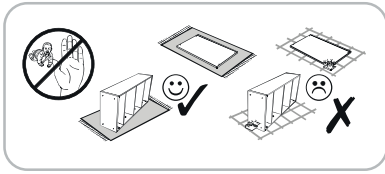

9

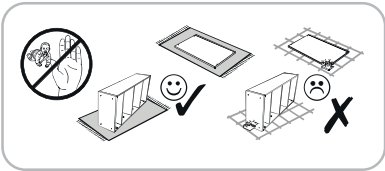

FA1  **x1**
4mm

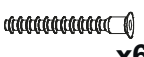

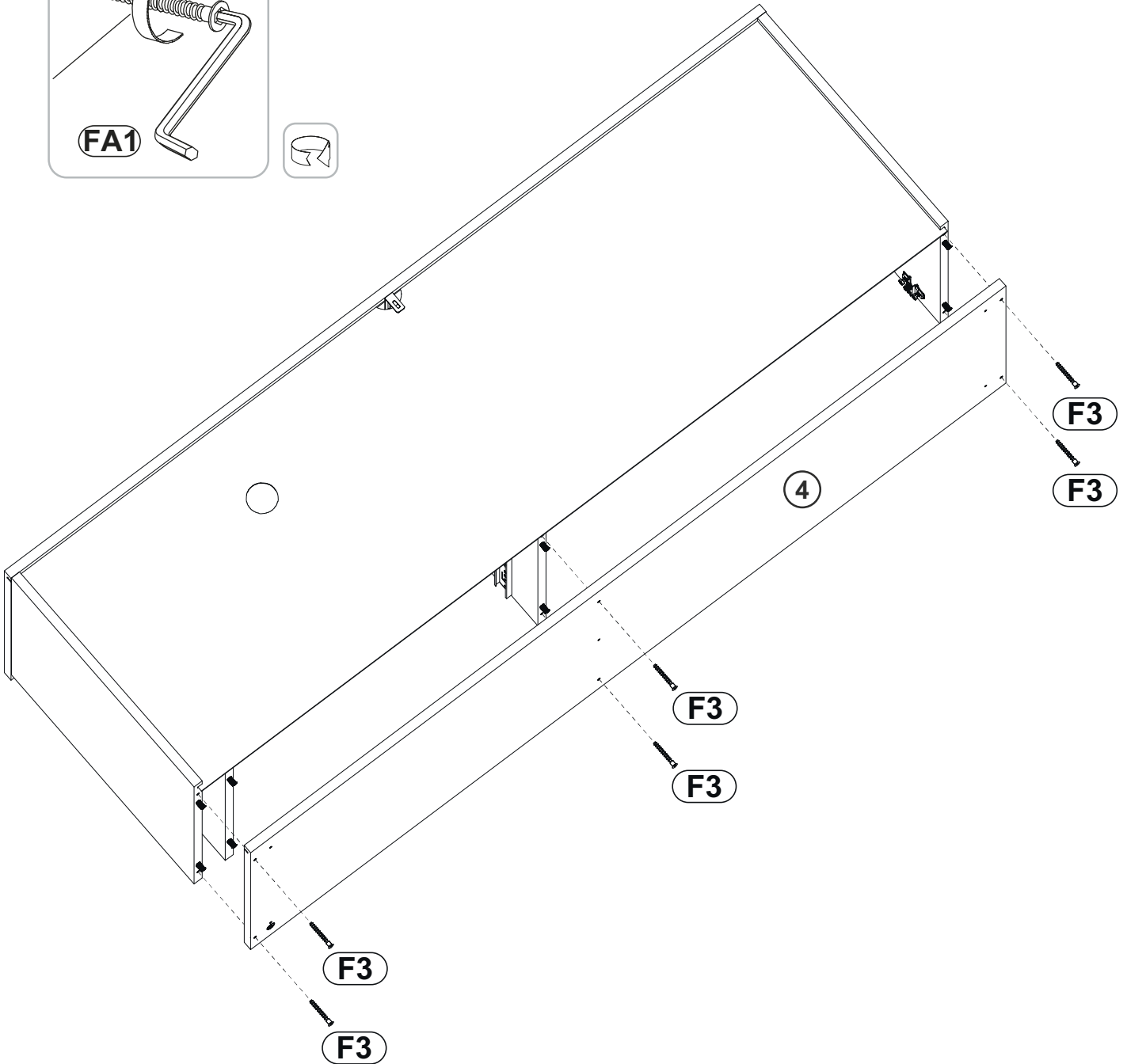
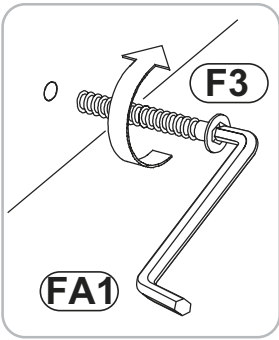
F3  **x6**
6,3x50

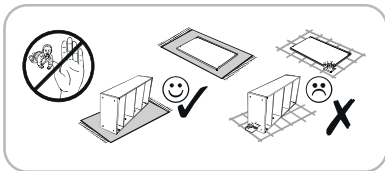

10

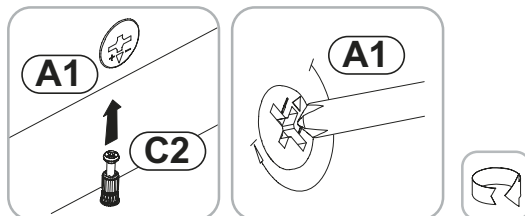
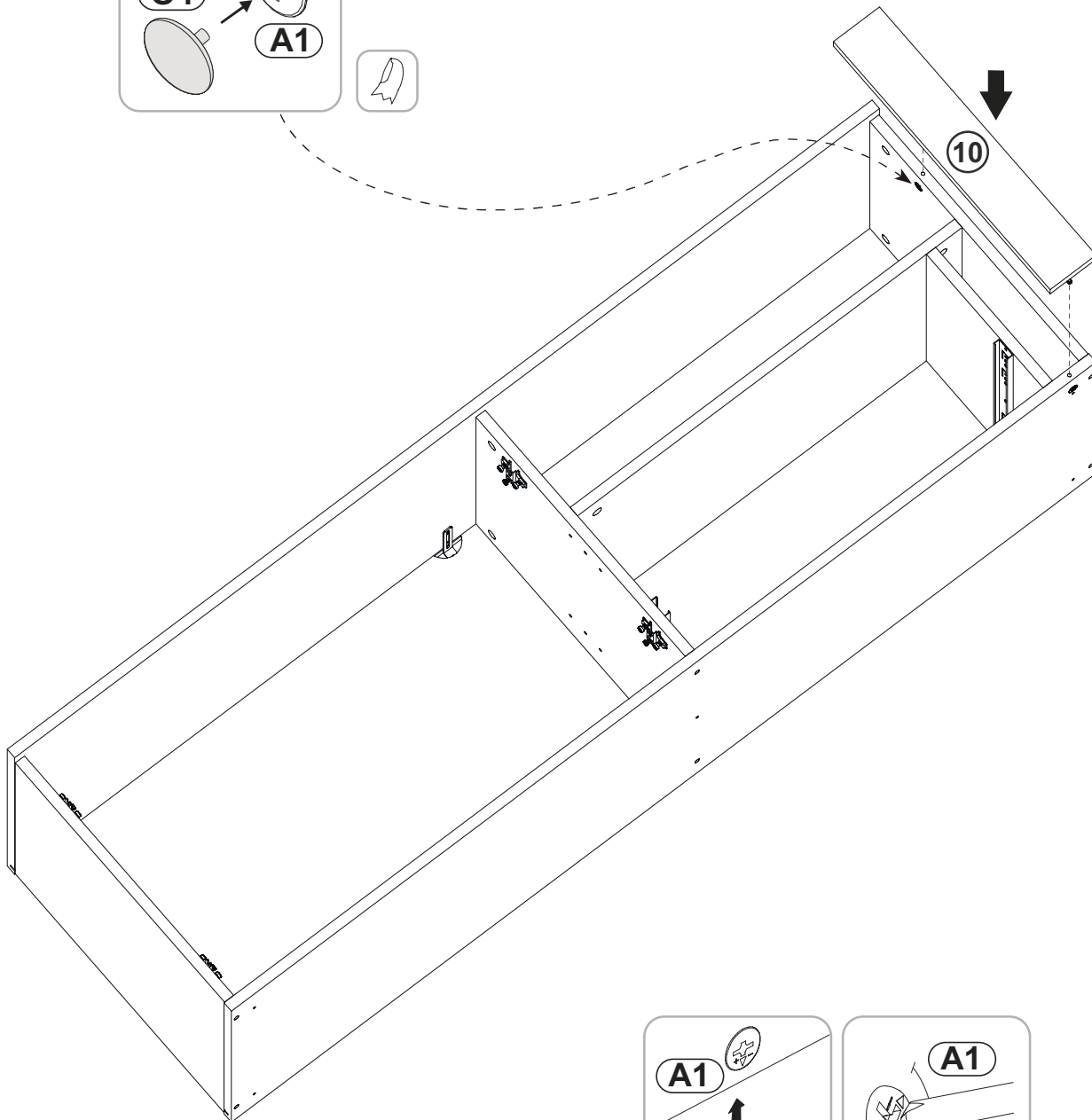
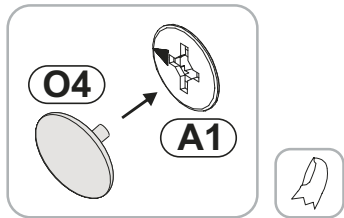

O4
Ø18 x1



11

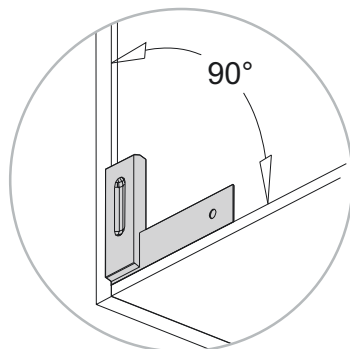
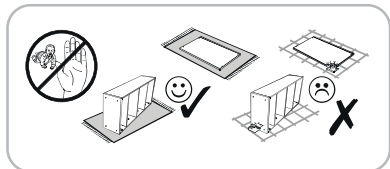

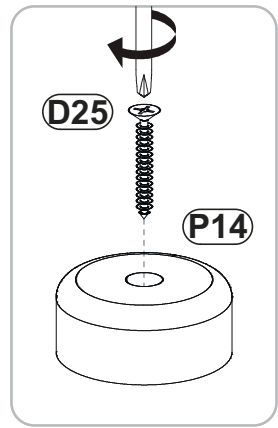
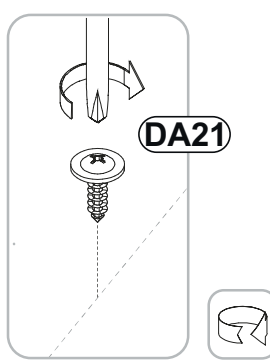
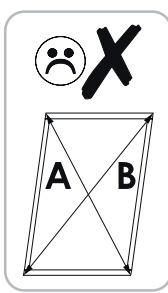
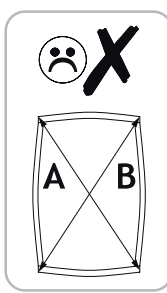
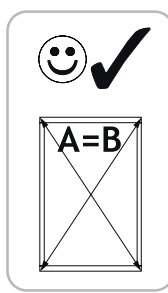
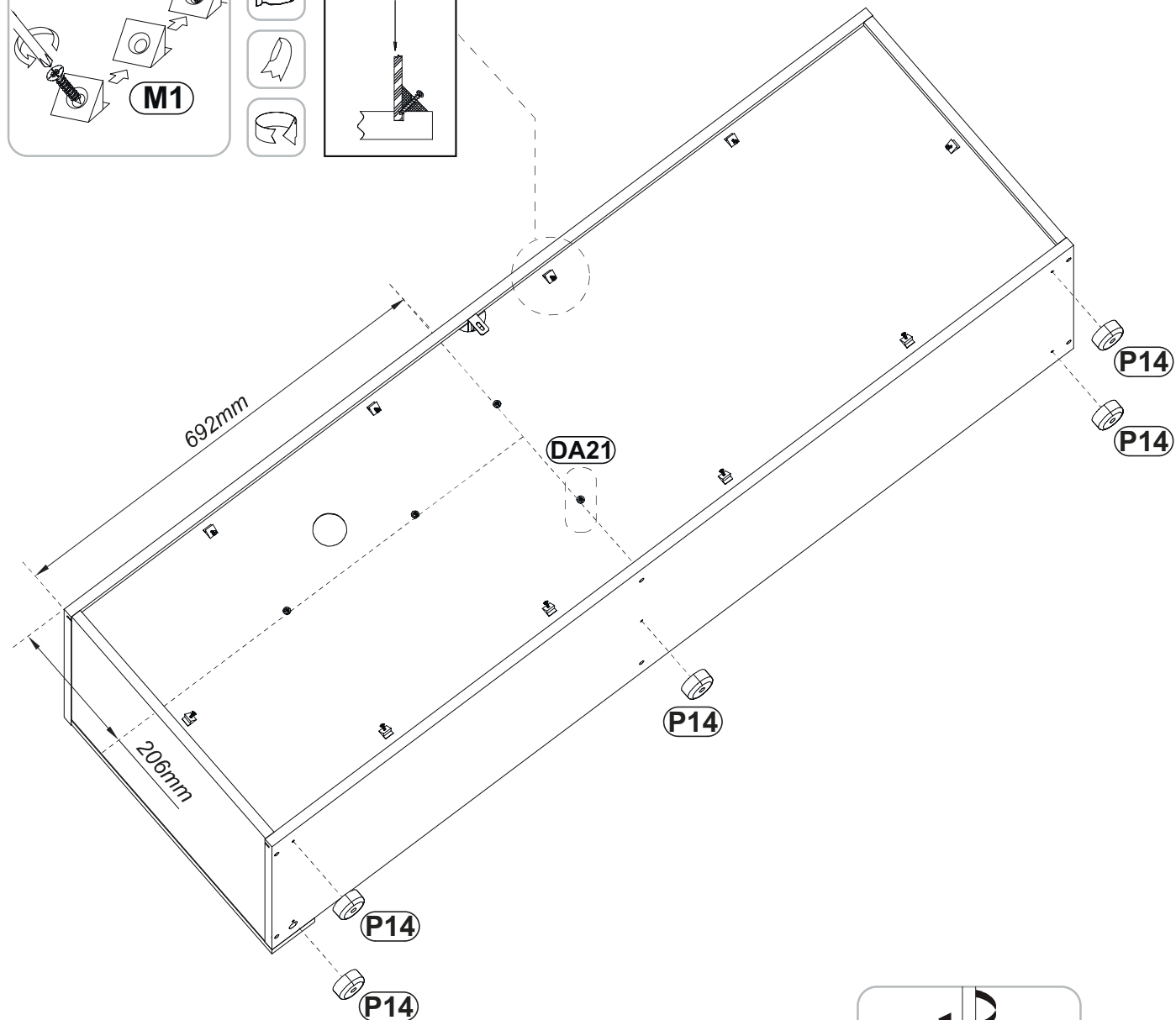
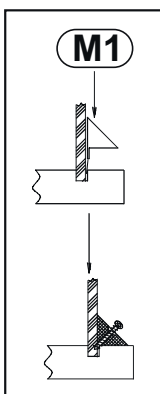
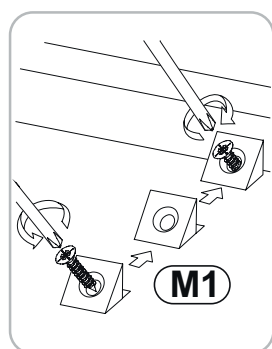

- M1**
10x10x15 x10
- DA21**
4,2x16 x4
- P14**
45x20 x5
- D25**
4x25 x5

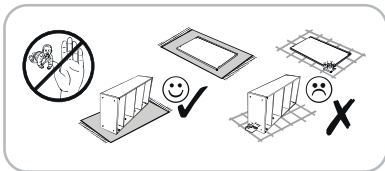

12



(N1)		x4
(Y37)		x1
(Y35)		x1

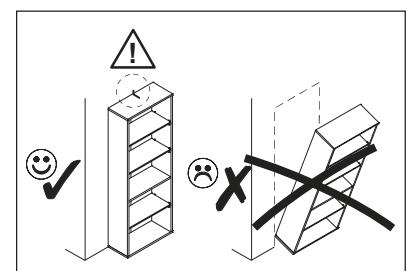
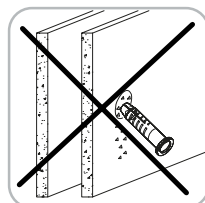
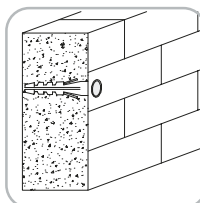
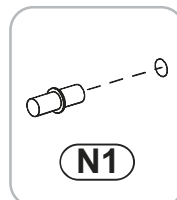
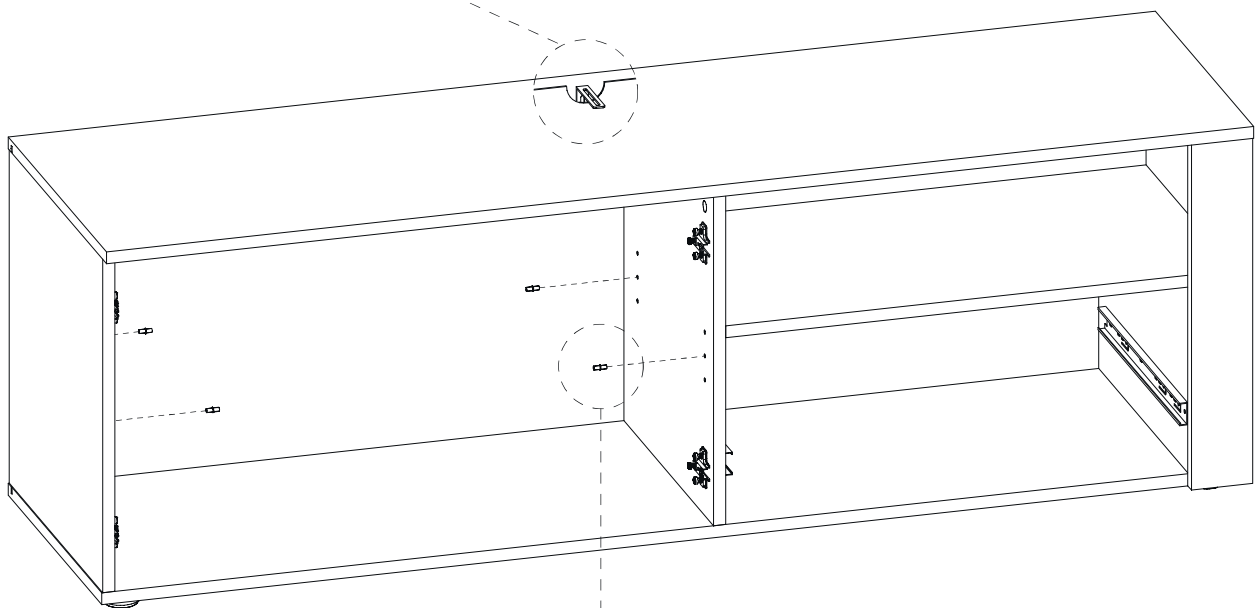
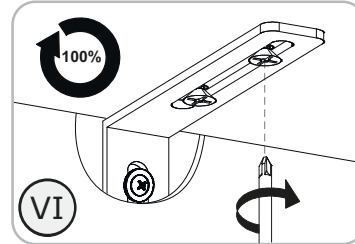
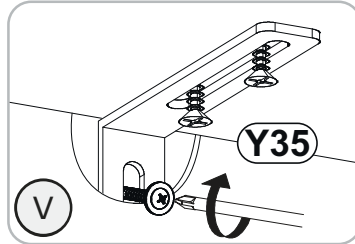
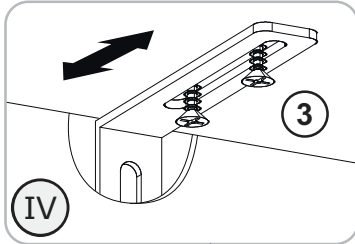
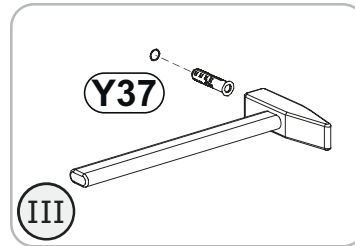
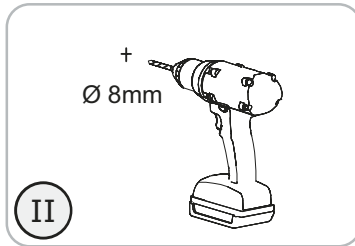
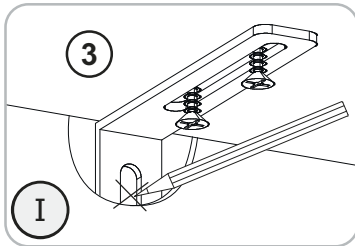

13

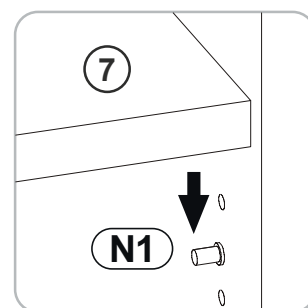
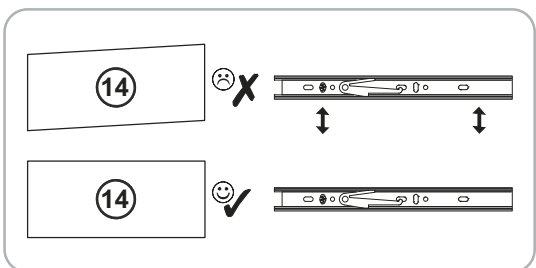
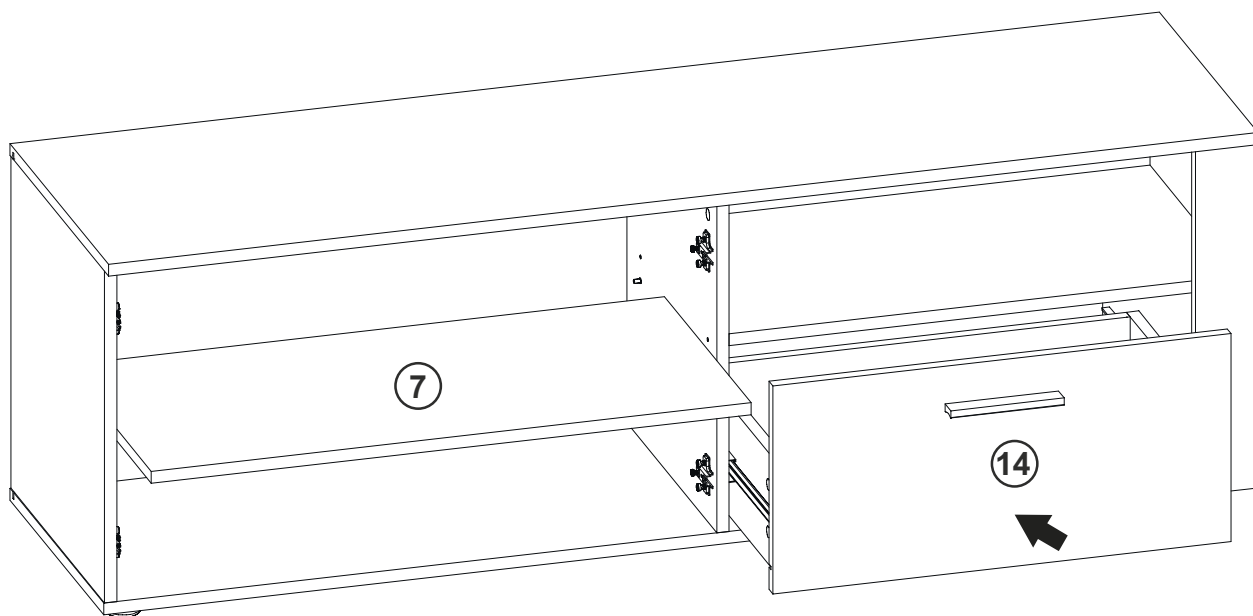
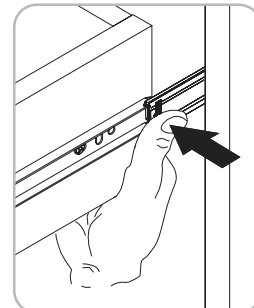
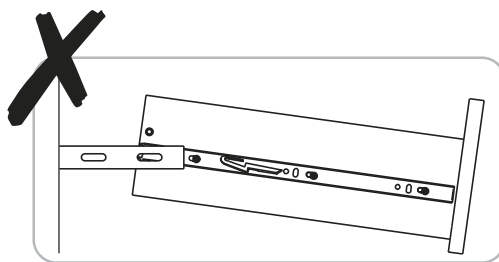
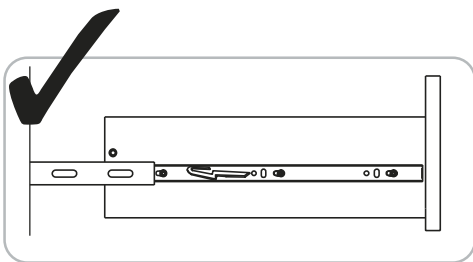
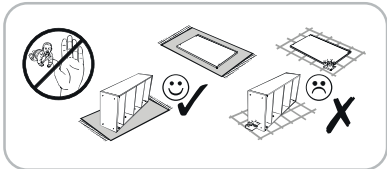

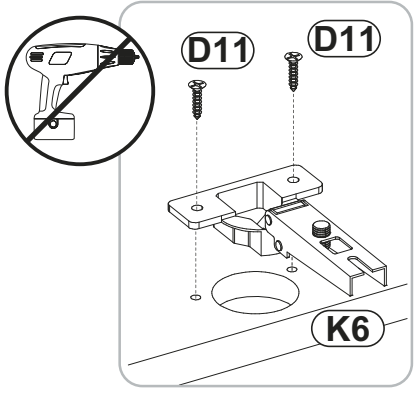
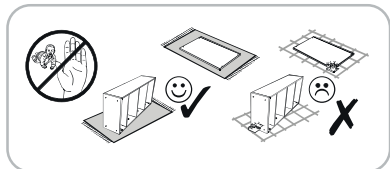

K6
Ø35 x4

D11
3,5x16 x8

DB2
4x25 x2

J65
128/148 x1

R10
Ø10 x2

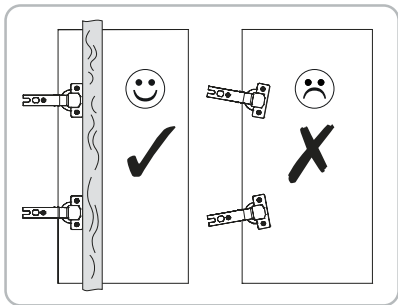
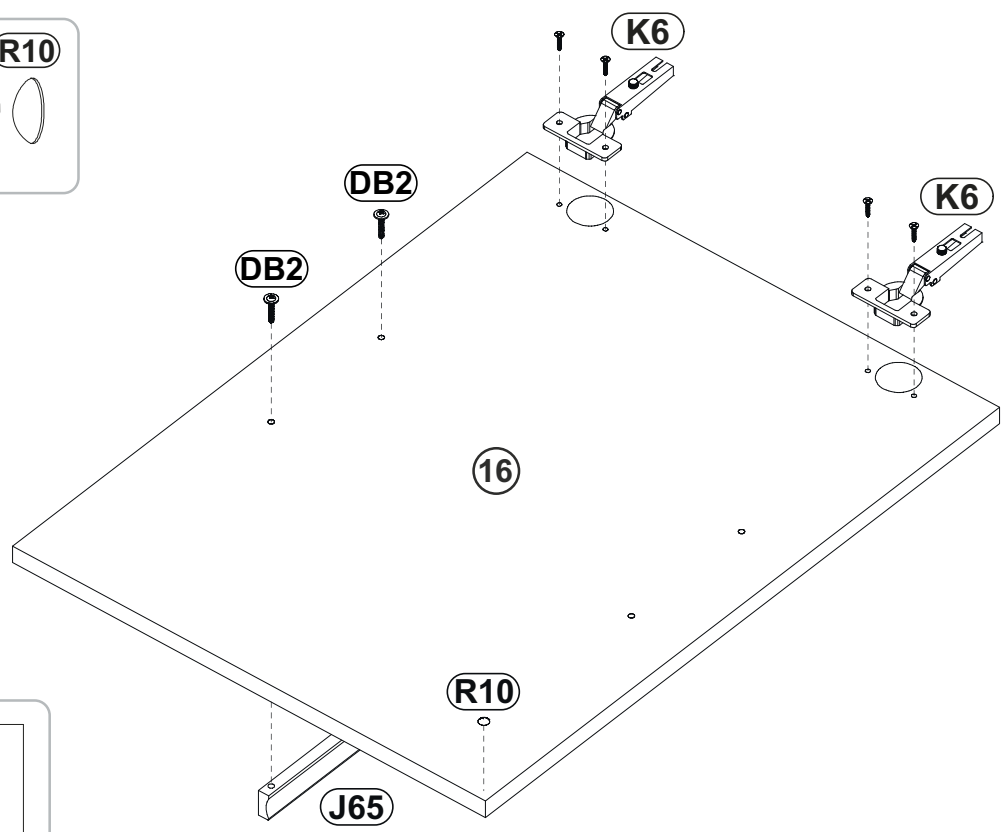
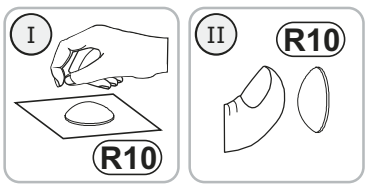
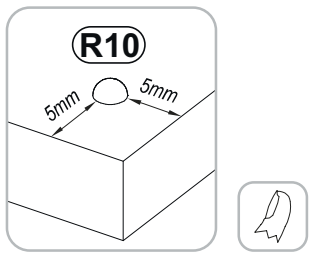
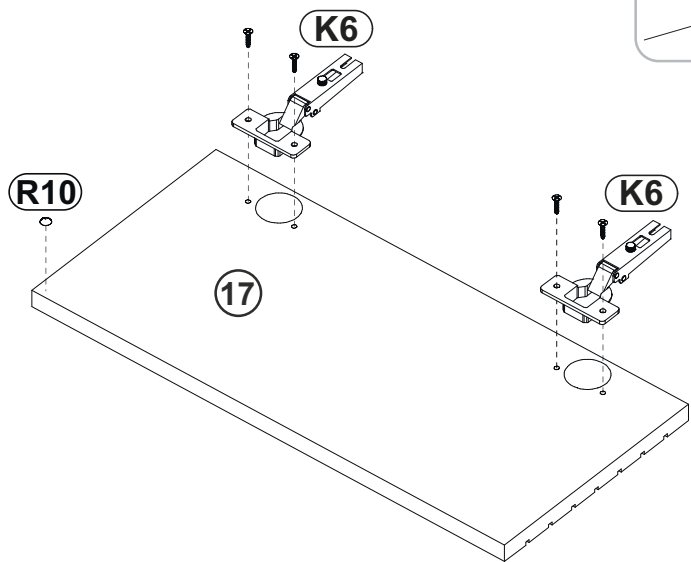

15

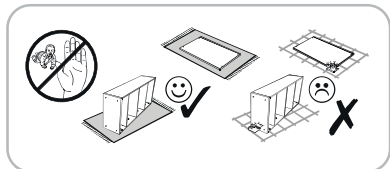

R6  x1

