

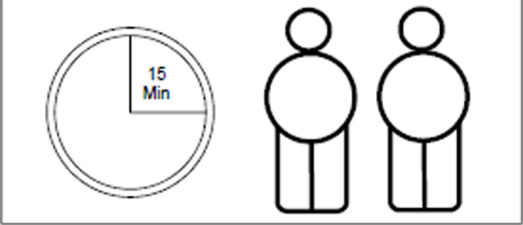



ART.NR. 67954



HARDWARE

A1	A2	A3	A4
 =X4	 =X8	 =X1	 =X8
LEGS	BOLT	ALLEN KEY	WHASHER

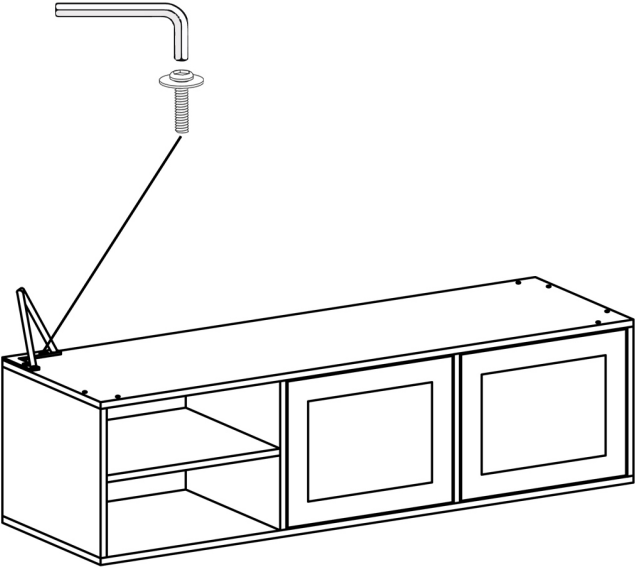

STEP 1

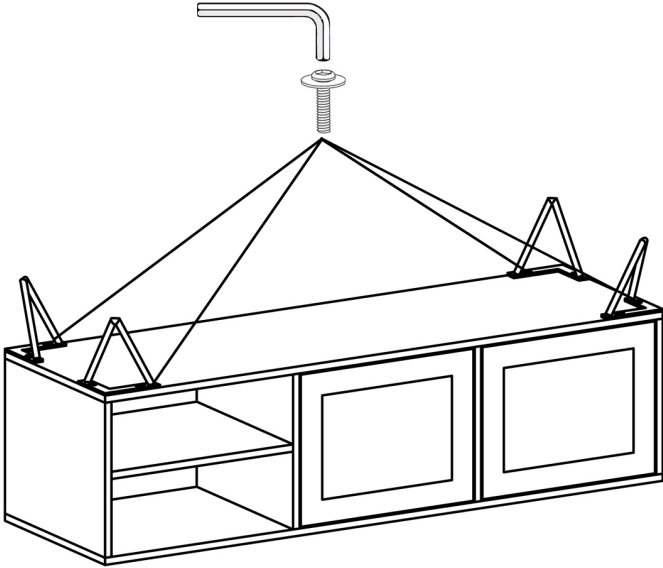

STEP 2

