

SANTO
1071/5010/3300
3100/5010/1073

- | | | | |
|-----------|--|-----------|---|
| D | MONTAGEANLEITUNG
BEDIENUNGSANLEITUNG | GB | ASSEMBLY INSTRUCTIONS
INSTRUCTION MANUAL |
| NL | HANDLEIDING VOOR DE MONTAGE
GEBRUIKSAANWIJZING | PL | INSTRUKCJA MONTAŻU
INSTRUKCJA OBSŁUGI |
| TR | MONTAJ TALIMATI
KULLANIM KLAVUZU | RU | ИНСТРУКЦИЯ ПО МОНТАЖУ
ИНСТРУКЦИЯ ПО ЭКСПЛУАТАЦИИ |
| RO | INSTRUCȚIUNI DE INSTALARE
INSTRUCȚIUNI DE UTILIZARE | IT | ISTRUZIONI DI MONTAGGIO
MANUALE DI ISTRUZIONI |
| FR | NOTICE DE MONTAGE
MANUEL INSTRUCTIONS | SK | MONTÁŽNY NÁVOD
NÁVOD NA POUŽITIE |
| HU | KÖZGYŰLÉS UTASÍTÁSOK
KEZELÉSI UTASÍTÁS | CZ | MONTÁŽNÍ NÁVOD
NÁVOD K POUŽITÍ |
| SI | NAVODILA ZA MONTAŽO
NAVODILA ZA UPORABO | PT | INSTRUÇÕES DE MONTAGEM
MANUAL DO USUÁRIO |
| ES | INSTRUCCIONES DE MONTAJE
MANUAL DEL USUARIO | HR | UPUTE ZA MONTAŽU
UPUTE ZA UPOTREBU |

F/B

220202

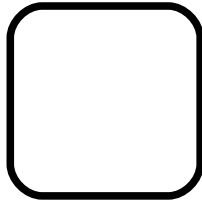
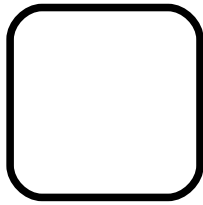

0019

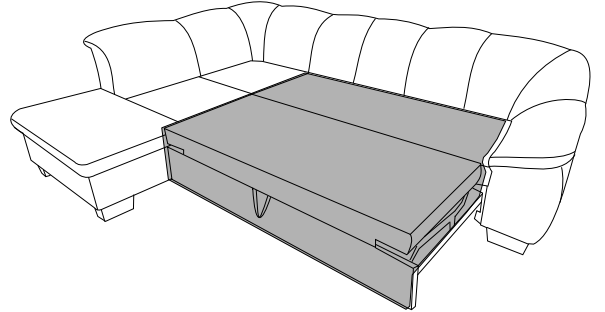
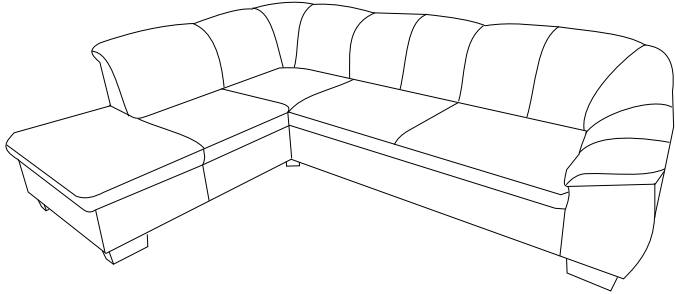

0019

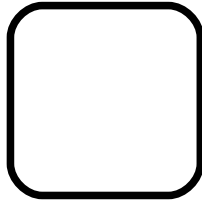
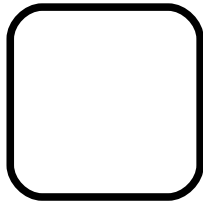

0088

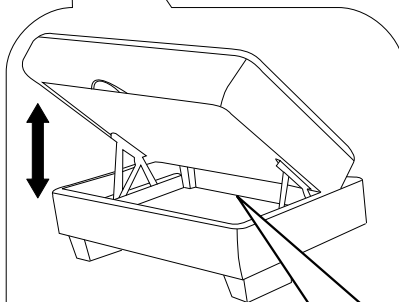
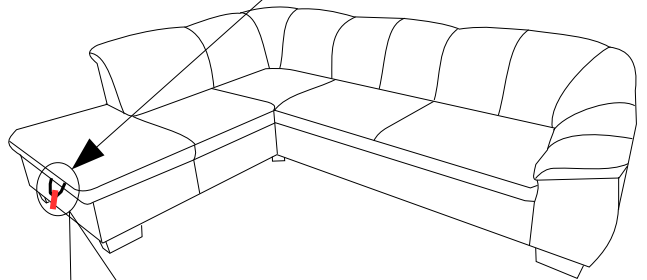
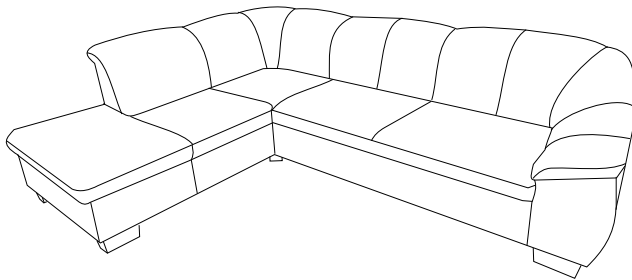
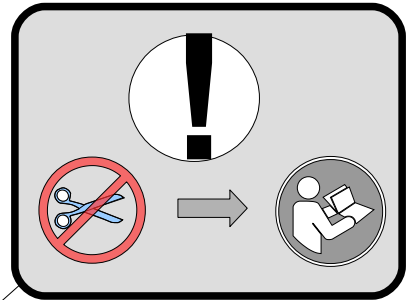





0088



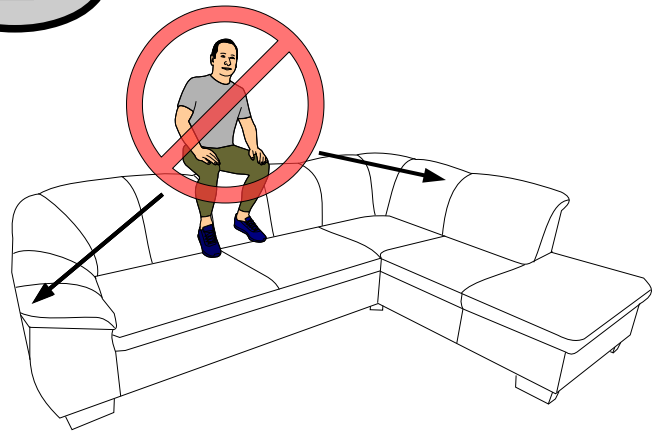
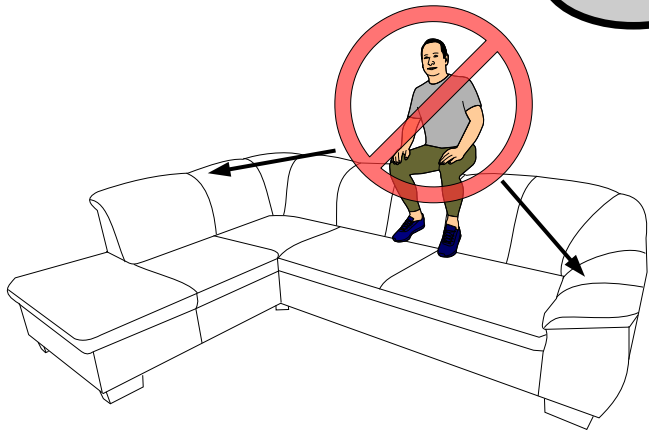



R



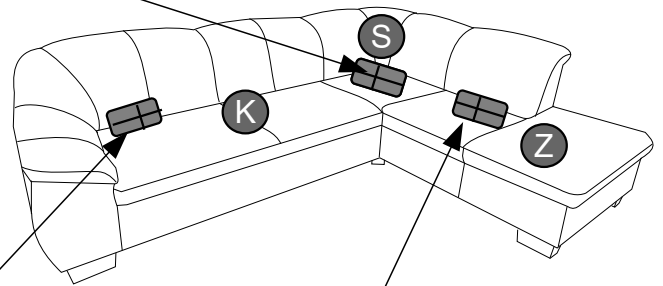
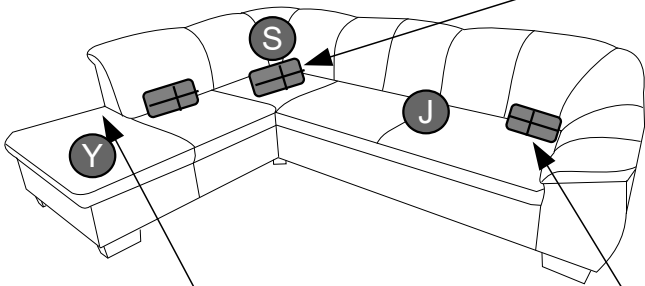

L



X Fi- 50  X4	q M8*80  X4	i L- 5  X1	f H- 90 [mm]  X4
--	---	--	---



X Fi- 50  X4	s H- 90  X2	q M8*80  X4	i L- 5  X1
--	---	---	---



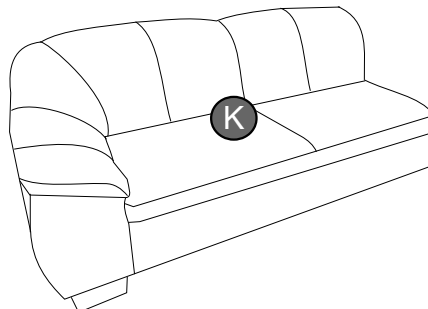
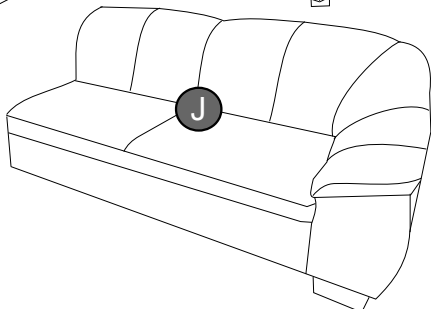
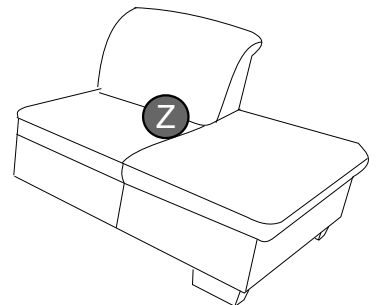
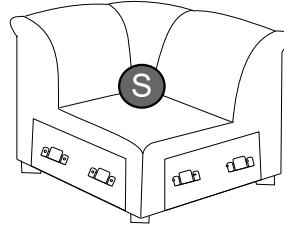
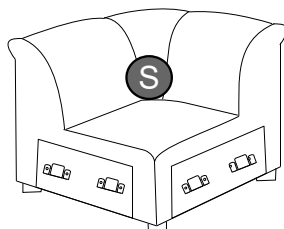
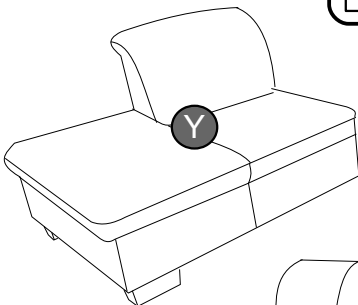

g H(70-120)  X2	X Fi- 50  X4	v H- 90  X2	q M8*80  X4	i L- 5  X1
---	--	---	---	--

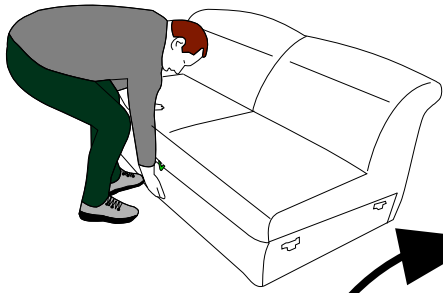





0
10
20
30
40
50
60
70
80
90
100
110
120
130
140
150
160
170
180
190
200



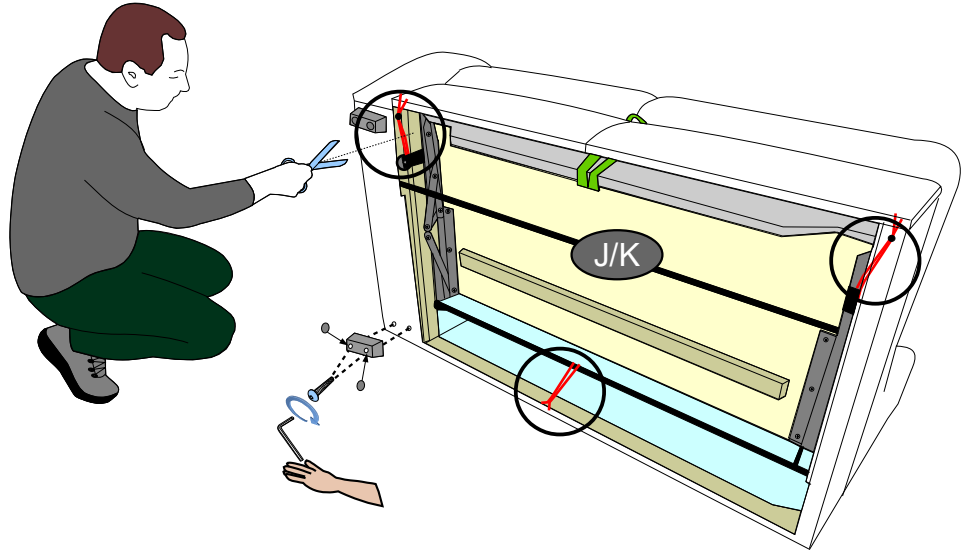



90°

X Fi- 50  X4	S H- 90  X2	q M8*80  X4	i L- 5  X1
--	---	---	---

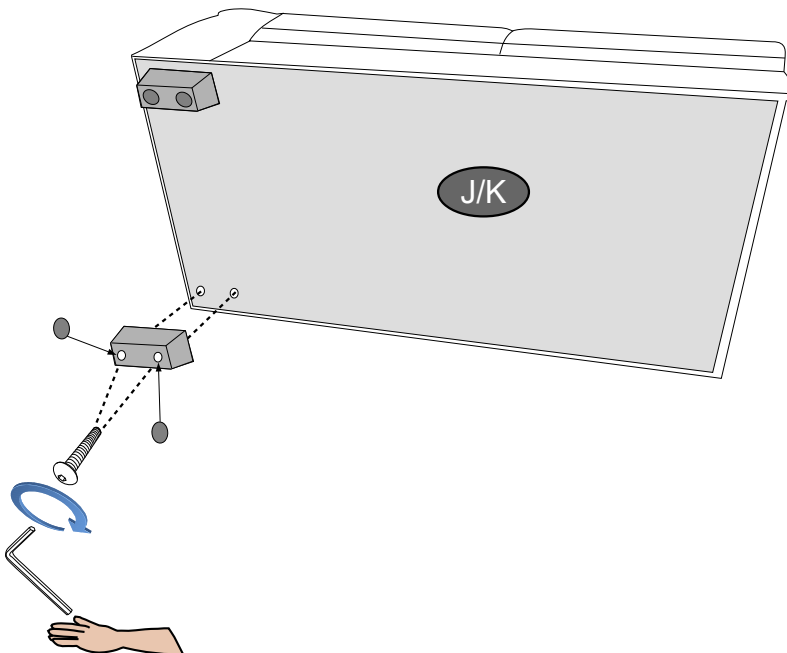





X Fi- 50  X4	S H- 90  X2	q M8*80  X4	i L- 5  X1
--	---	---	--

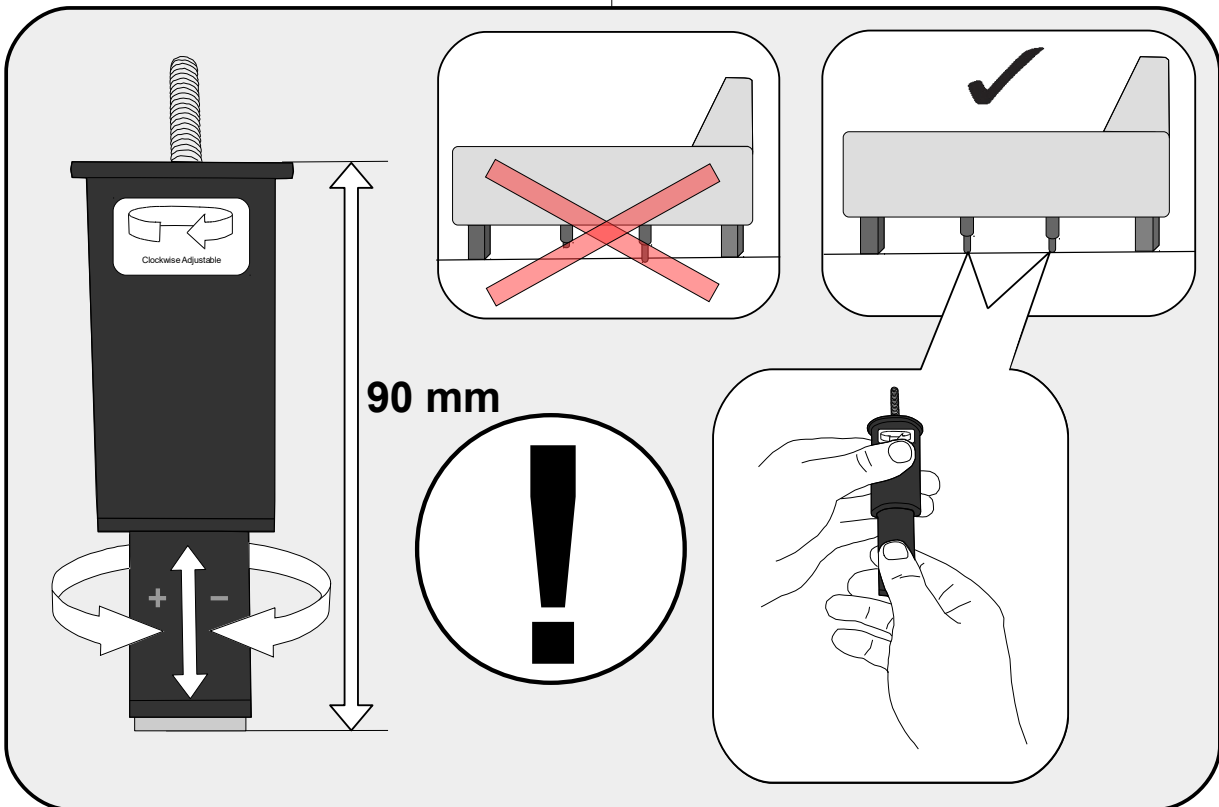
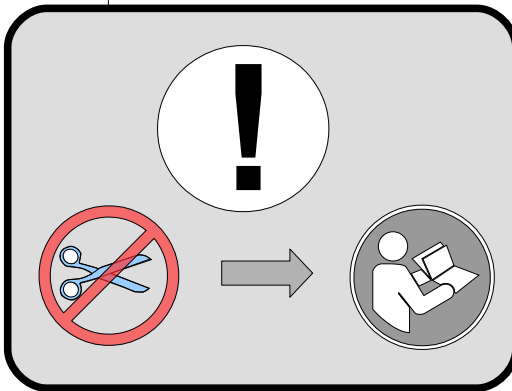
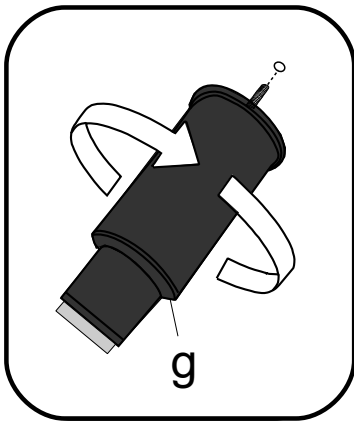
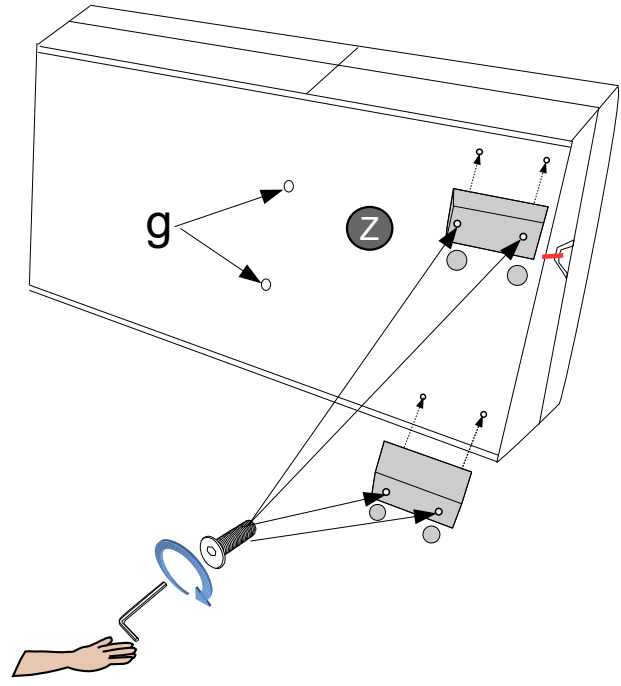
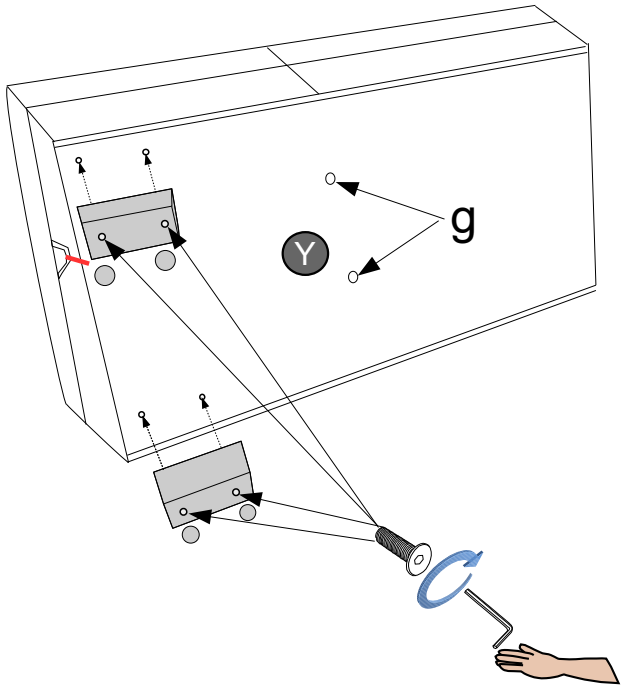

g H(70-120)	X Fi- 50	v H- 90	q M8*80
			
X2	X4	X2	X4



f H-90	q M8*80	i L-5	x Fi-50
			
X4	X4	X1	X4

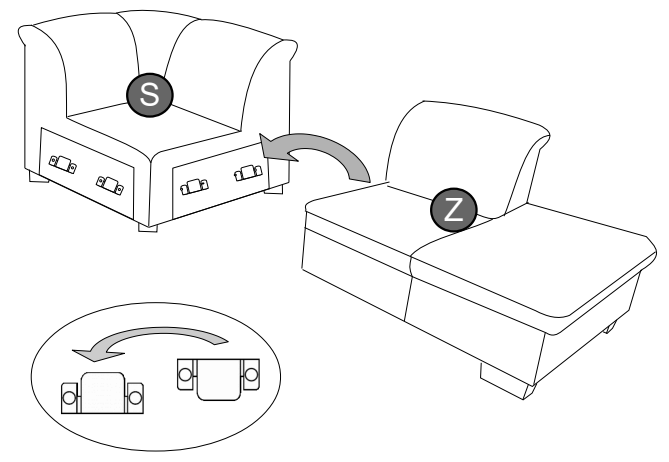
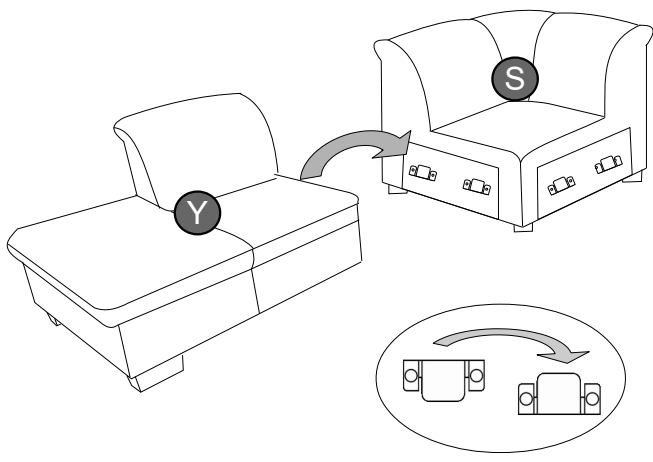
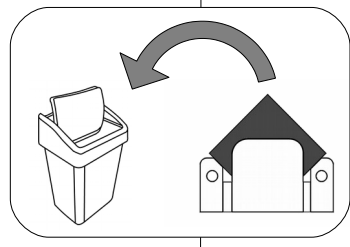
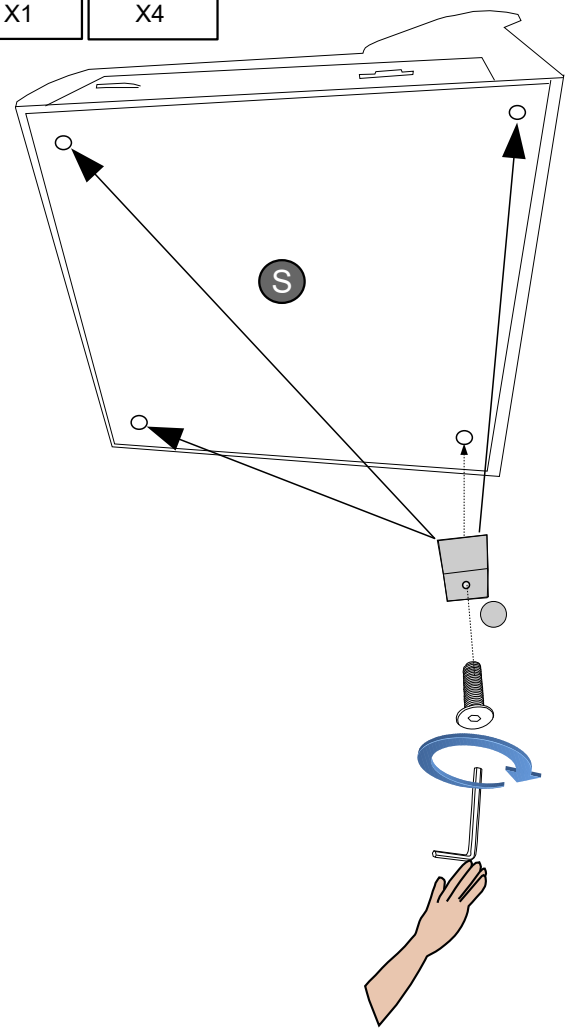
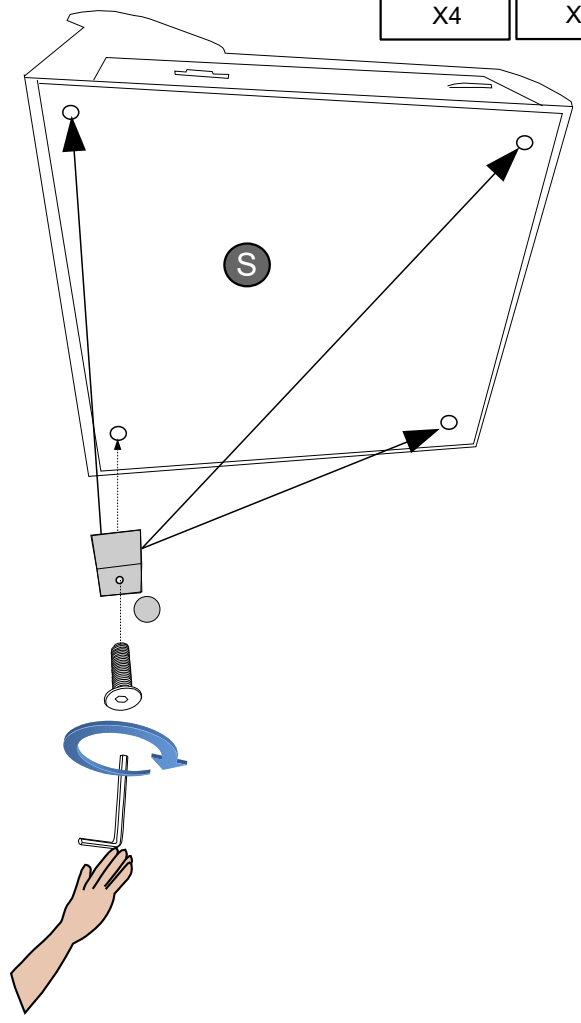

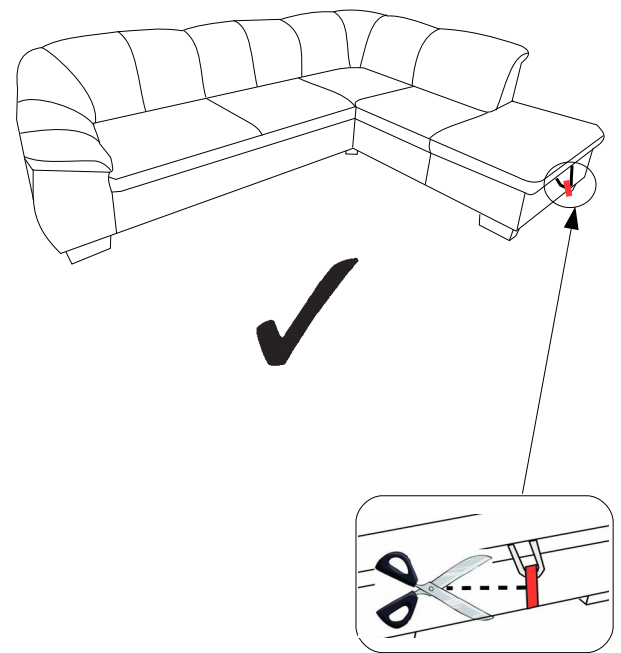
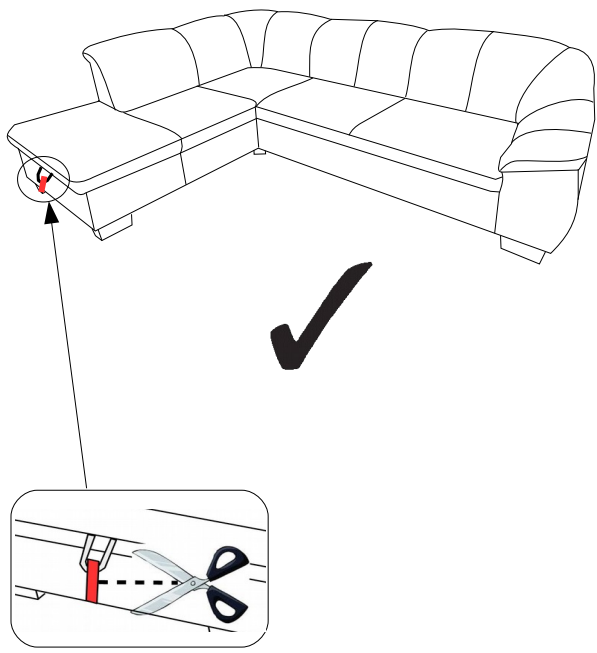
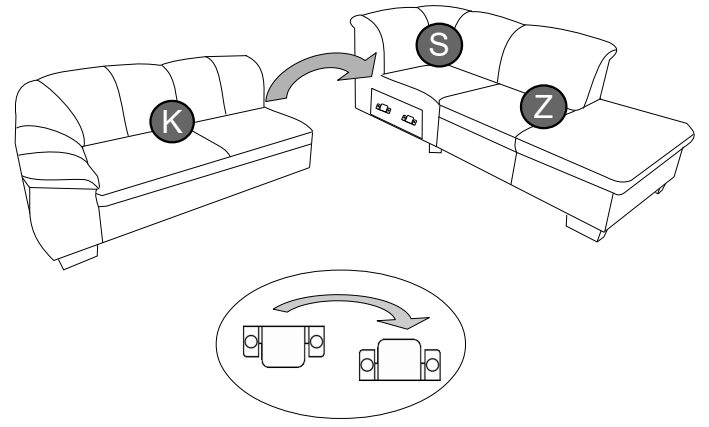
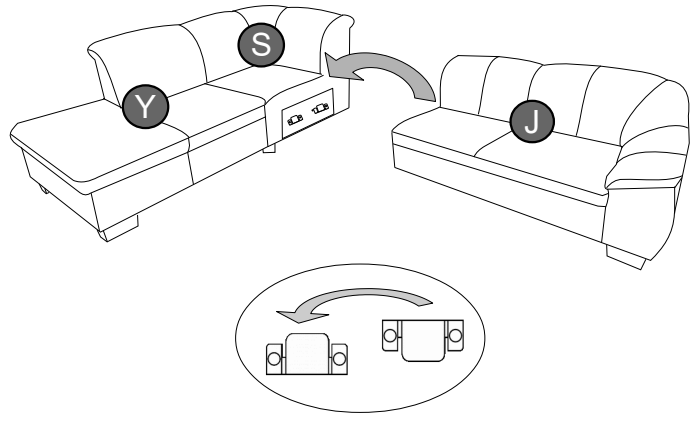

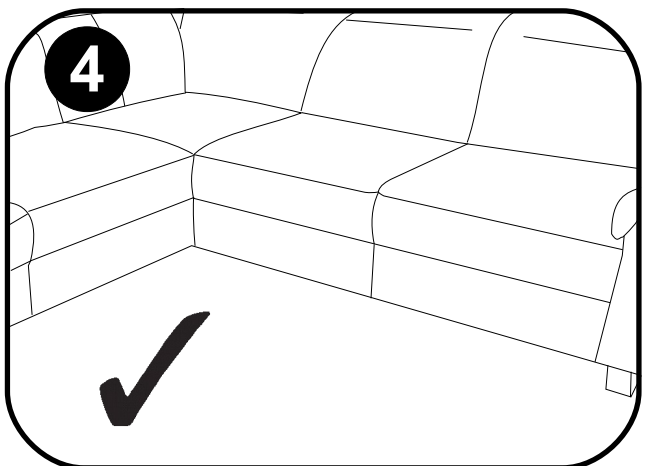
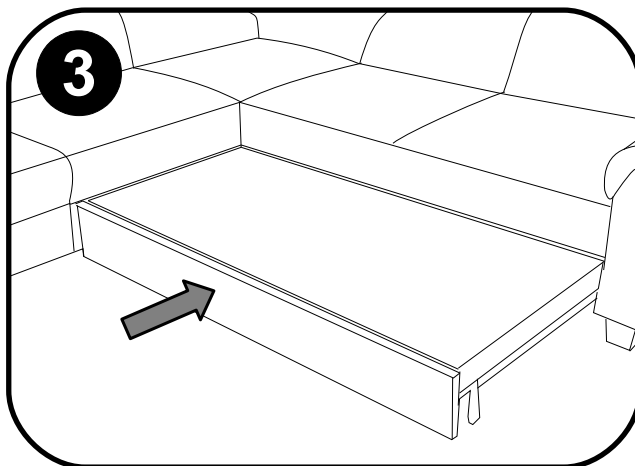
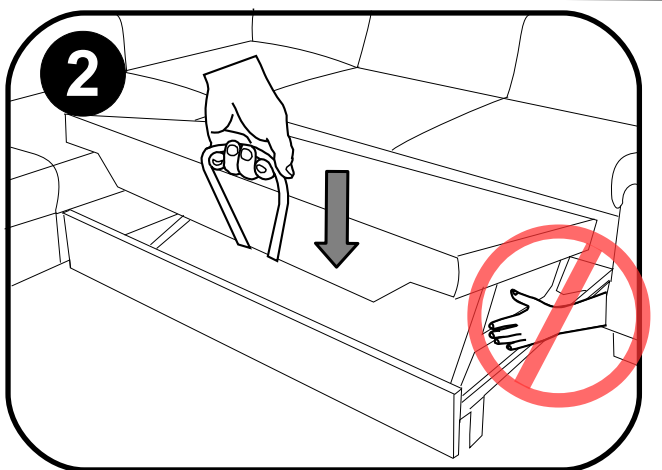
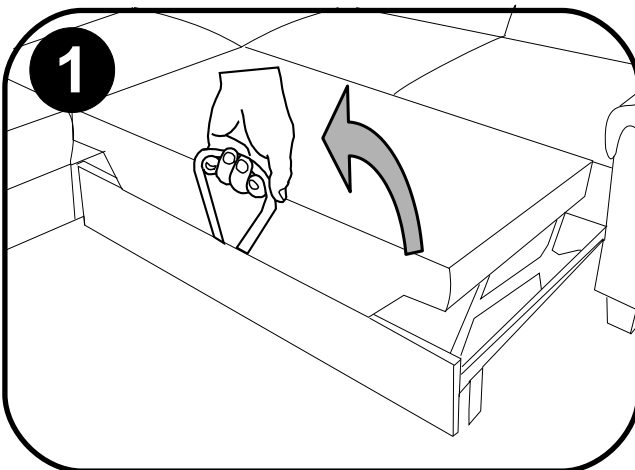
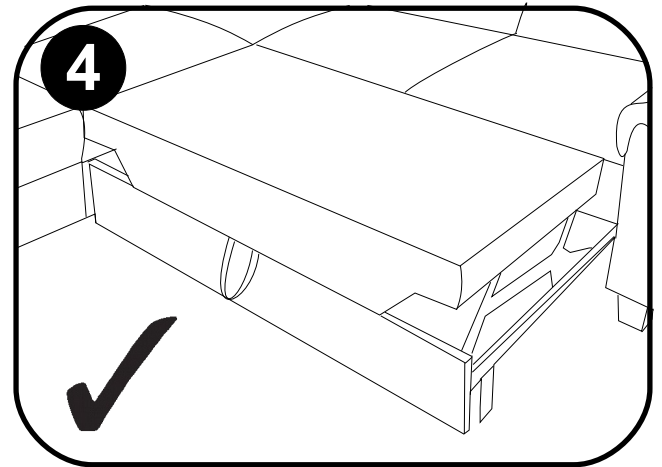
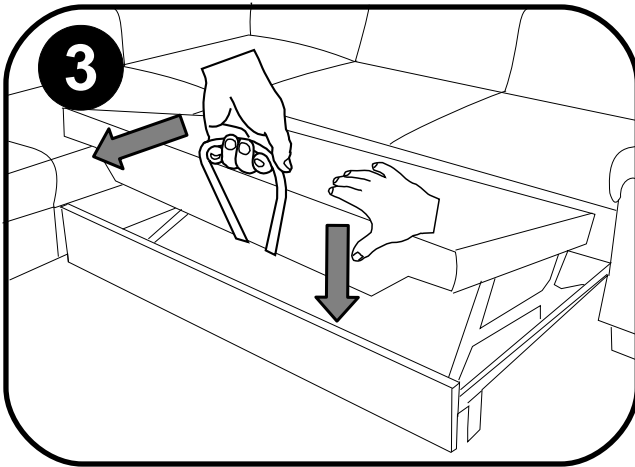
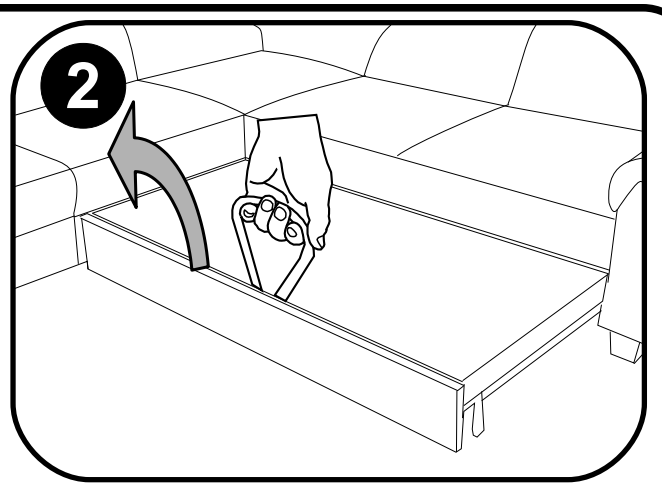
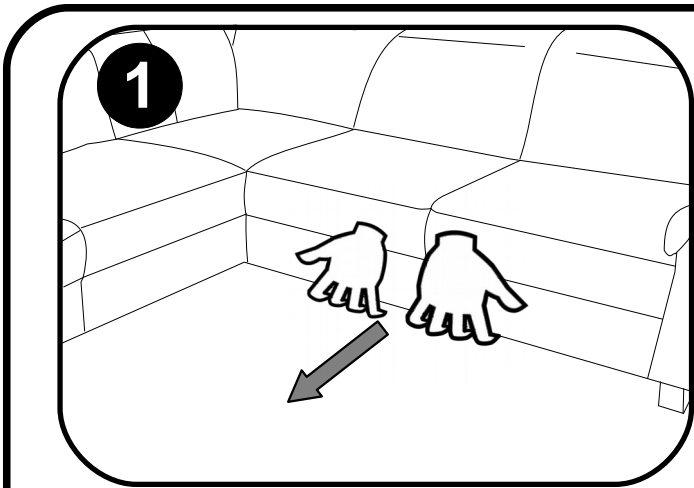
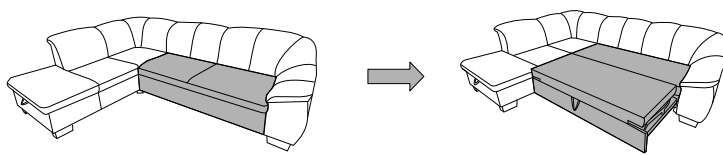

Service · Dienstverlening · Servis · Servis · Сервисная служба · Serviciu · Services · Servizio
 ·Servisný list · Szolgáltatás · Servisní list

Name · Naam · Nazwa · İsim · Название · Nume · Nome · Názov · Názov ·
 Název · Neve

SANTO

Typ · Type · Tip · Тип · Tipo · Típus

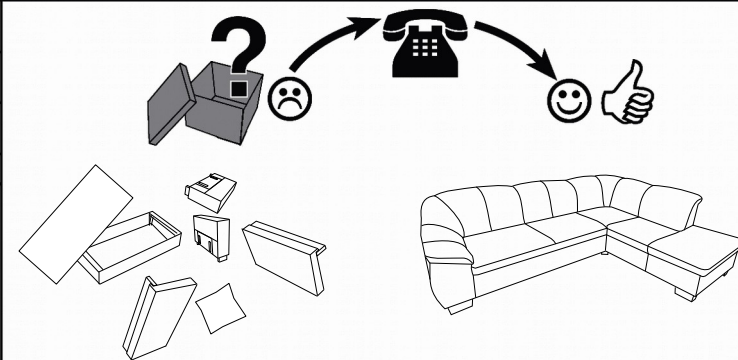
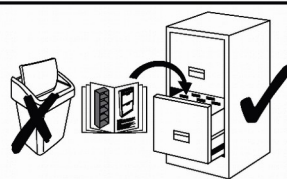

R

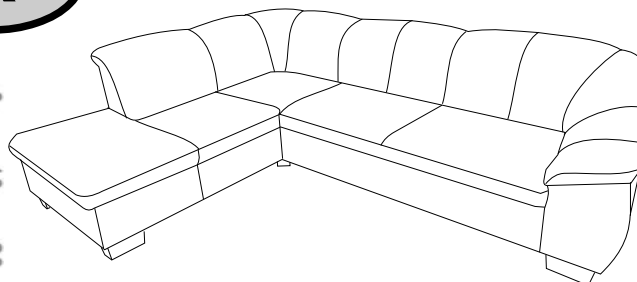

L

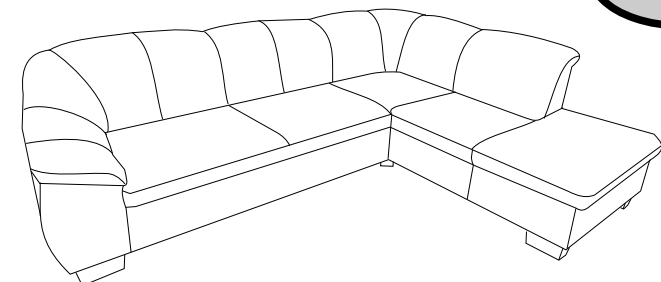

g H(70-120)	f H- 90	x Fi- 50	v H- 90	q M8*80 [mm]

