

SIENA 23M

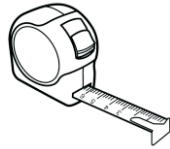

Option L

Option R

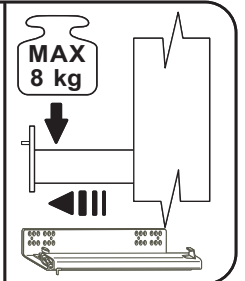
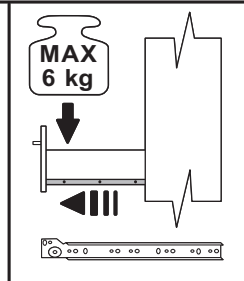
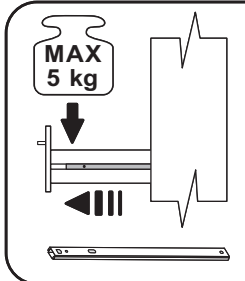
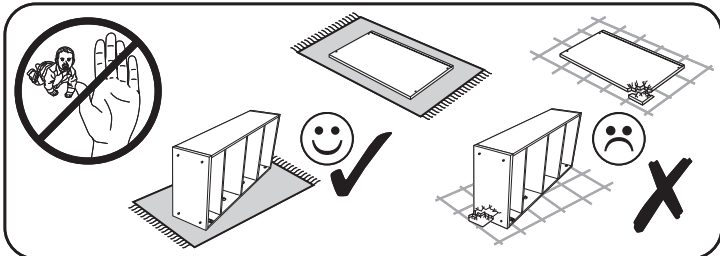
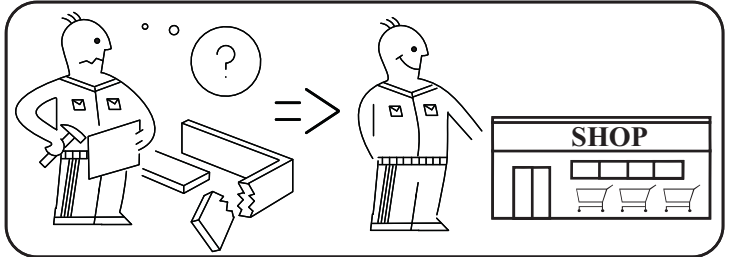
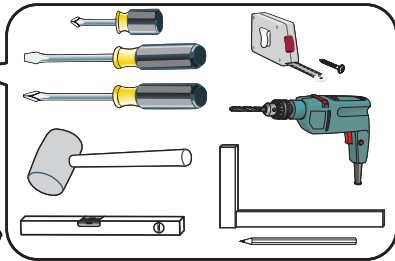
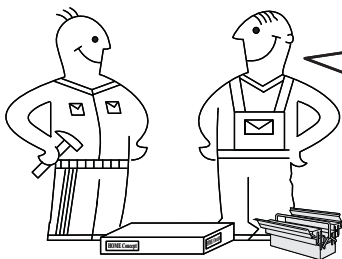
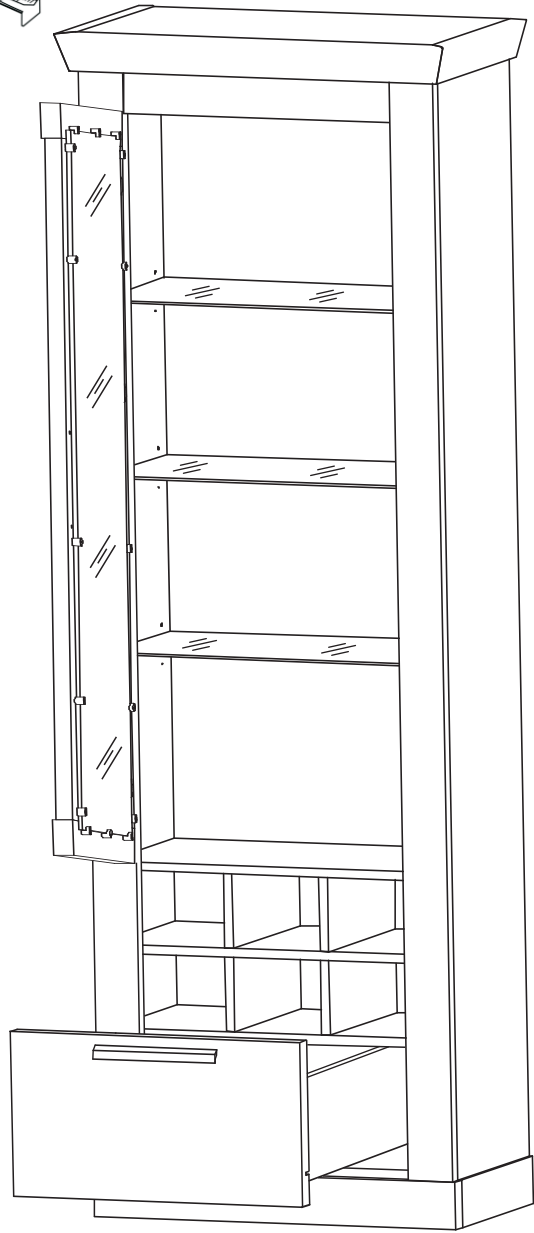
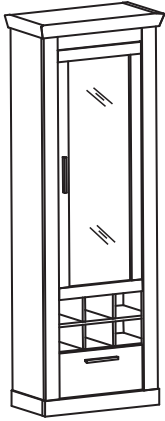
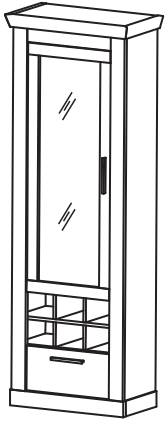

SIENA 23M

max.



MHC12



max.



MHC15

MHC16 MHC17

max.



MHC3

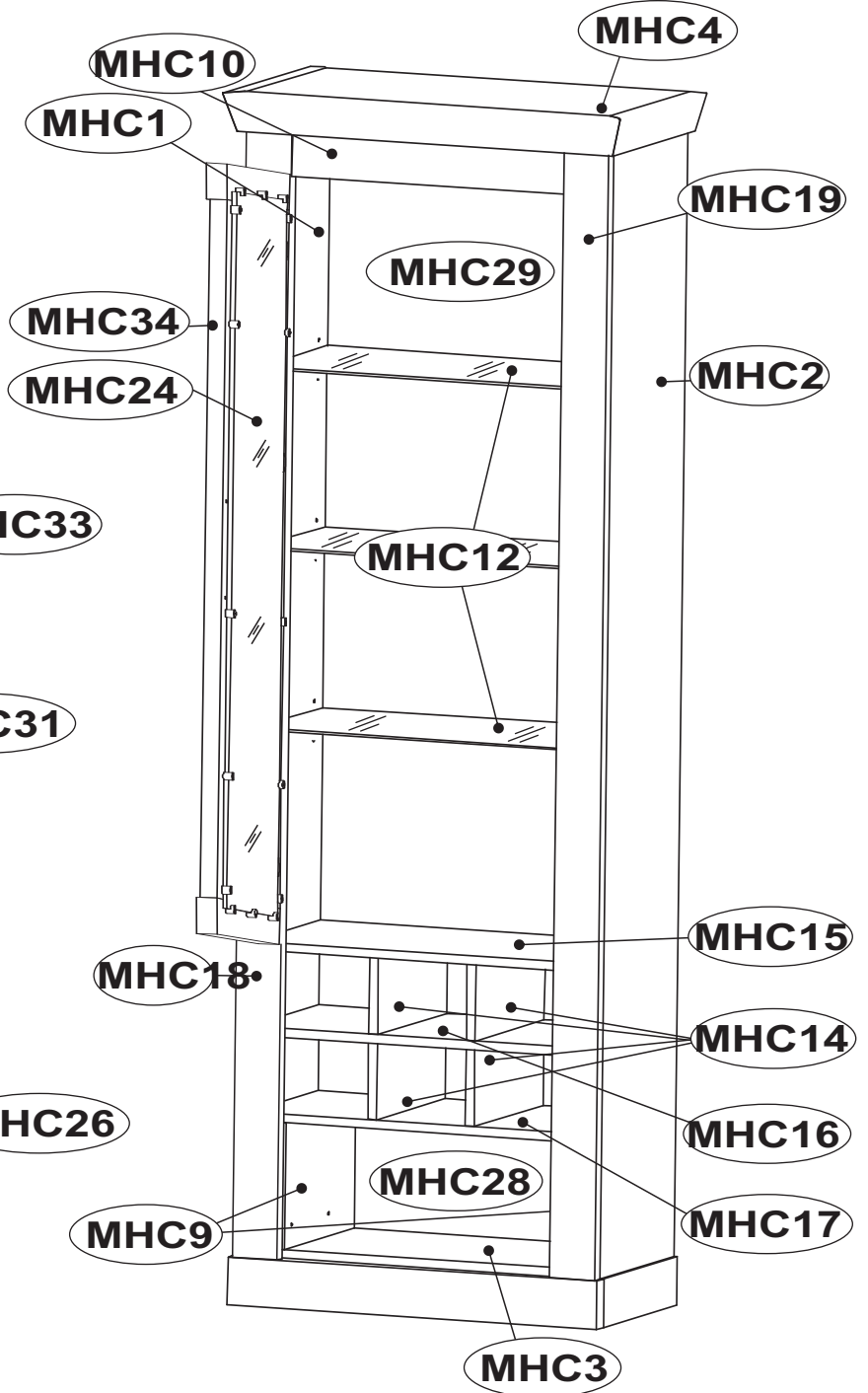
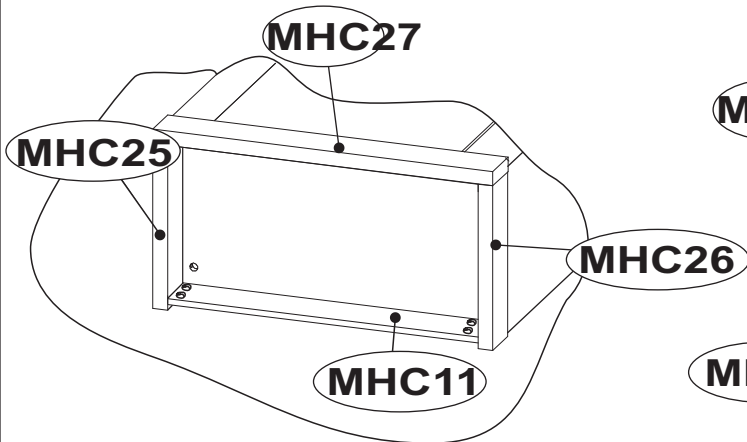
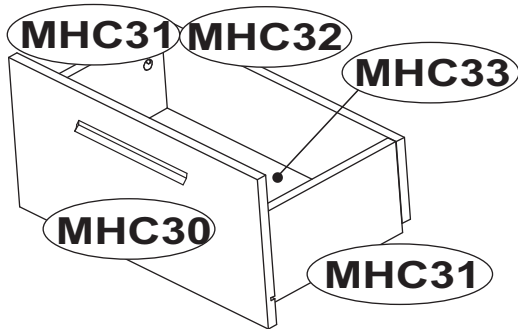

MHC1	x1	1911	320	15	2/2
MHC2	x1	1911	320	15	2/2
MHC3	x1	611	299	15	1/2
MHC4	x1	706	374	65	1/2
MHC9	x2	209	250	15	2/2
MHC10	x1	483	124	18	2/2
MHC11	x1	590	80	15	1/2
MHC12	x3	610	290	15	1/2
MHC14	x4	124	298	15	1/2
MHC15	x1	611	299	15	1/2
MHC16	x1	611	299	15	1/2
MHC17	x1	611	299	15	1/2



MHC18	x1	1911	80	22	2/2
MHC19	x1	1911	80	22	2/2
MHC24	x1	1189	386	4	2/2
MHC25	x1	313	80	32	1/2
MHC26	x1	313	80	32	1/2
MHC27	x1	655	80	32	1/2
MHC28	x1	368	623	3	2/2
MHC29	x1	1546	623	3	2/2

MHC30	x1	477	230	15	2/2
MHC31	x2	237	140	15	1/2
MHC32	x1	466	126	15	2/2
MHC33	x1	447	258	3	2/2
MHC34	x1	1159	477	18	2/2

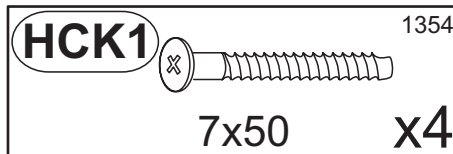
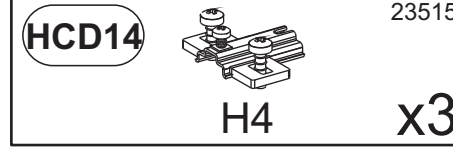
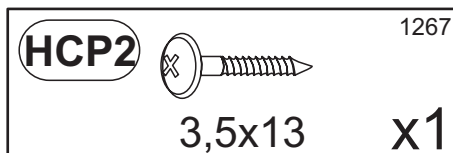
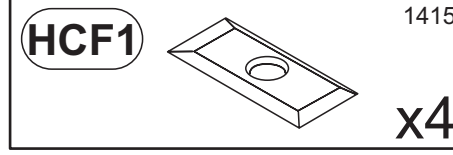
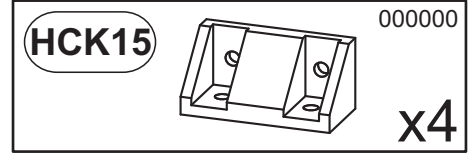
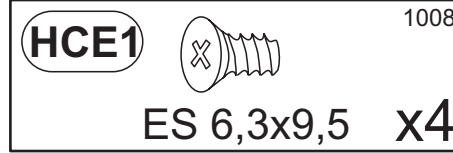
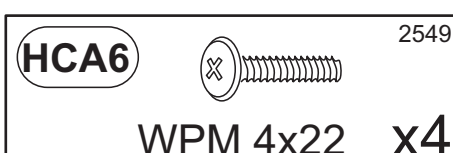
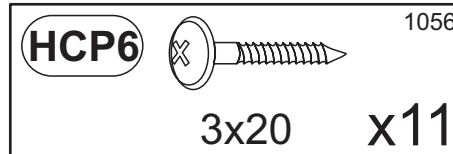
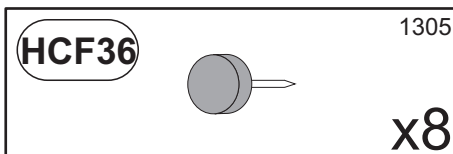
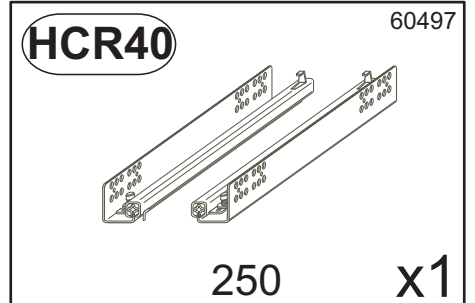
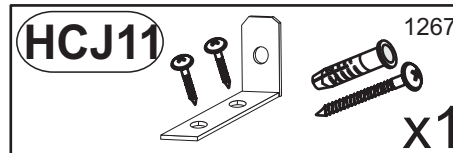
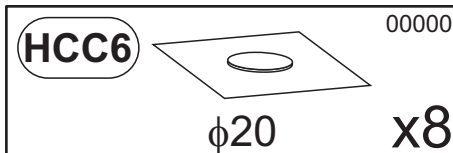
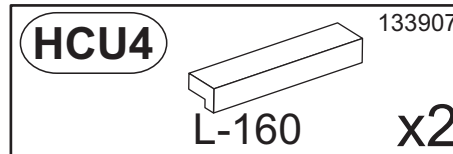
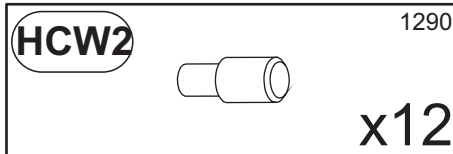
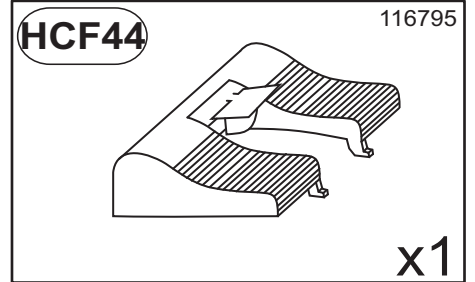
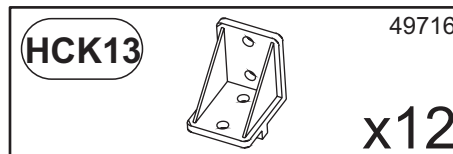
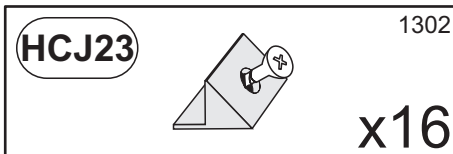
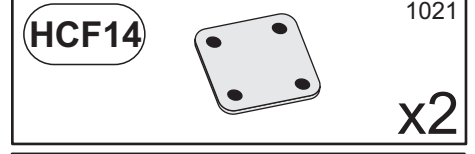
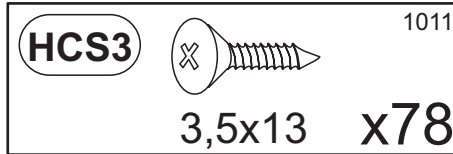
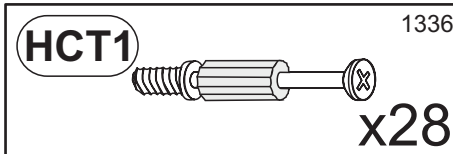
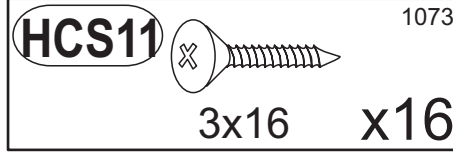
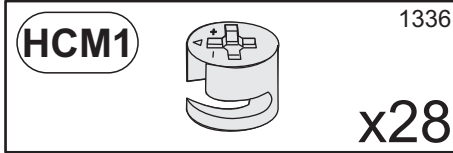
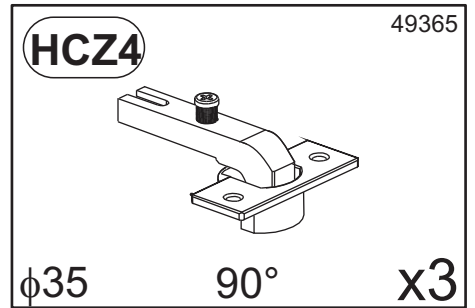
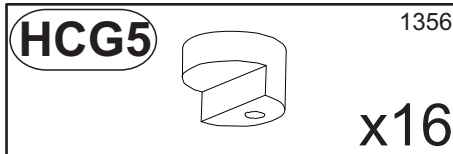
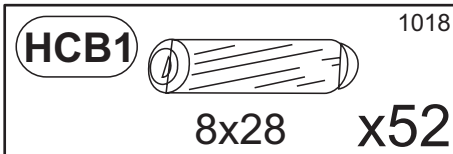
SIENA 23M



1

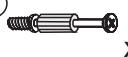

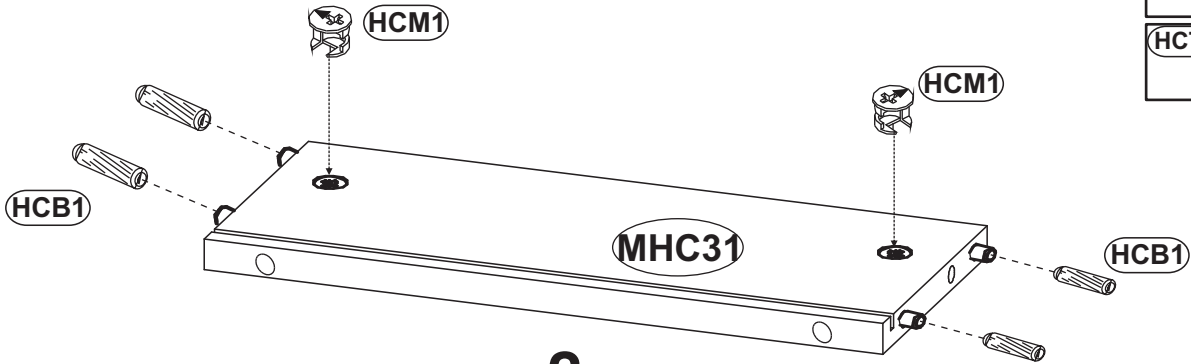
HCB1		1018
	8x28	x8
HCM1		123894
		x4
HCT1		11809
		x4

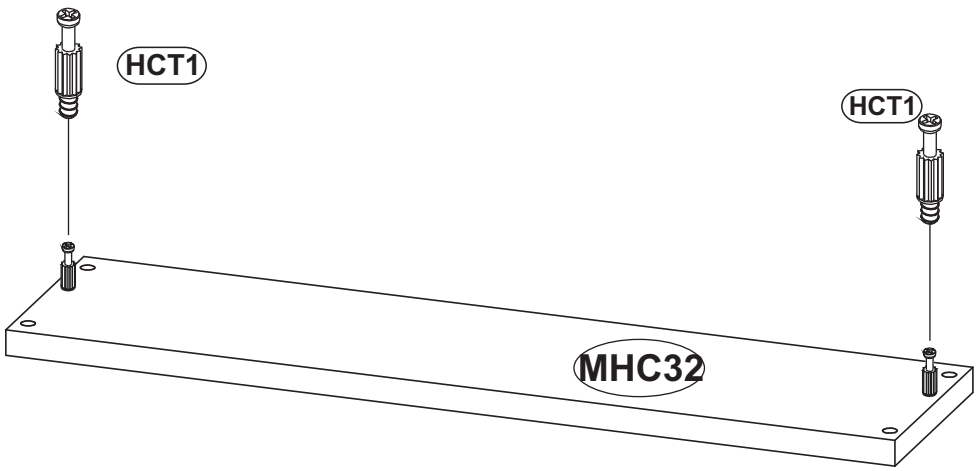
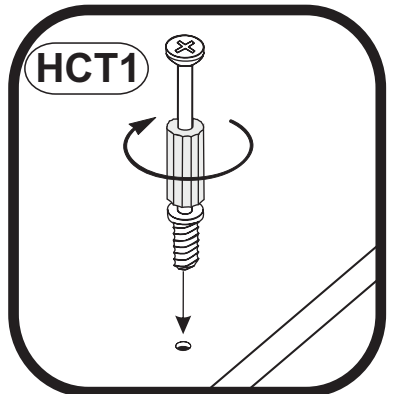
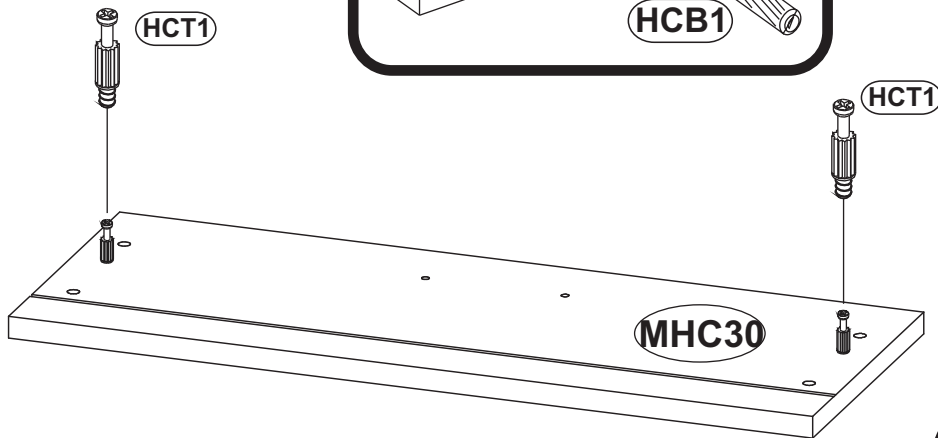
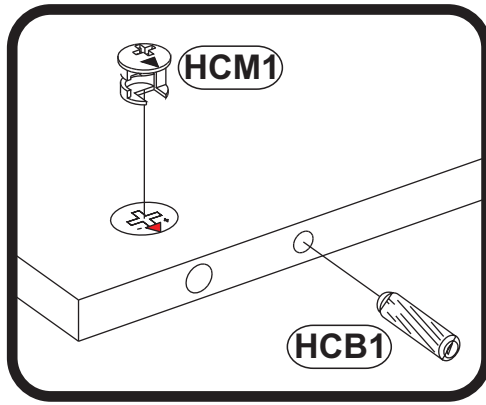

x2



2

HCJ23		1302
		x2
HCP6		1056
	3x20	x3

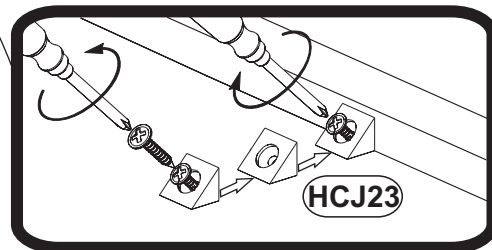
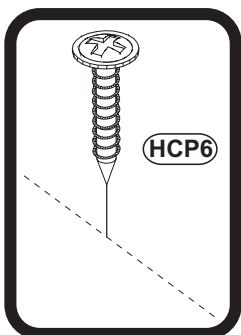
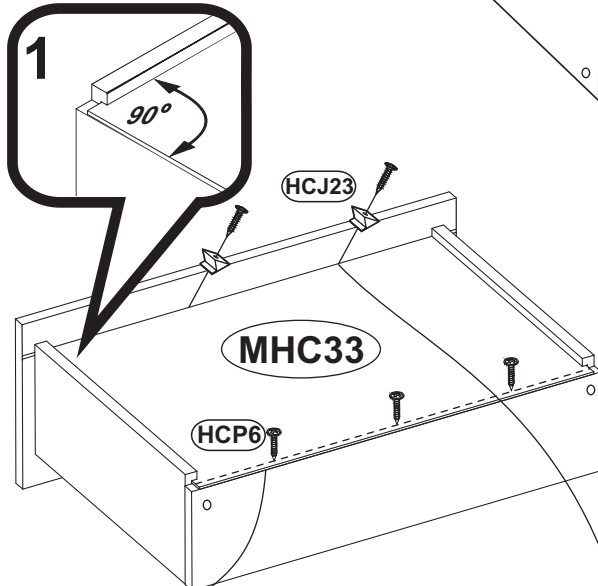
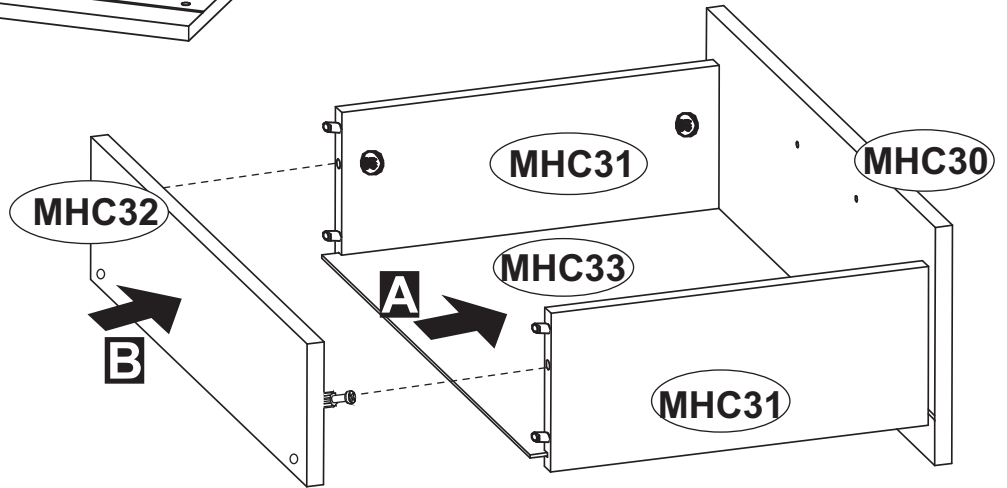
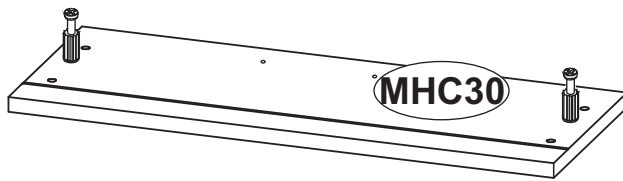
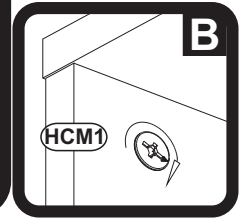
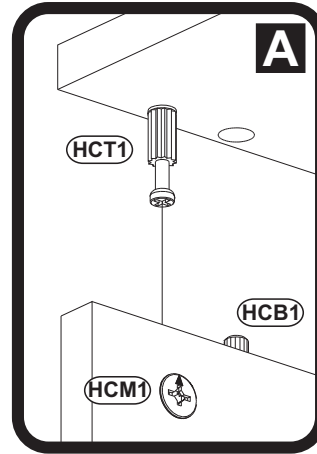
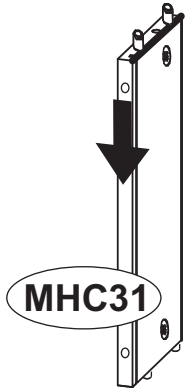

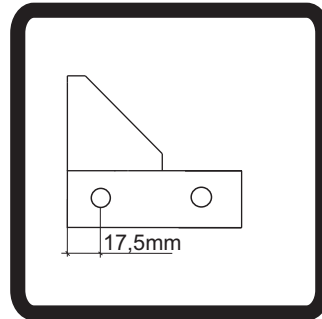
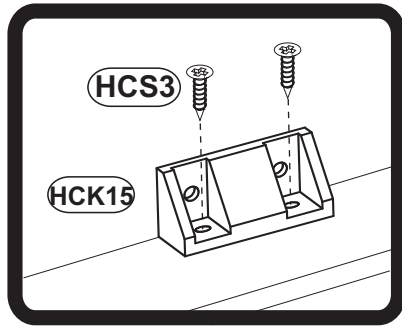

HCM1		123894	x8
HCT1		11809	x8
HCS3		1011	x8
HCB1		1018	x4
HCK15		000000	x4

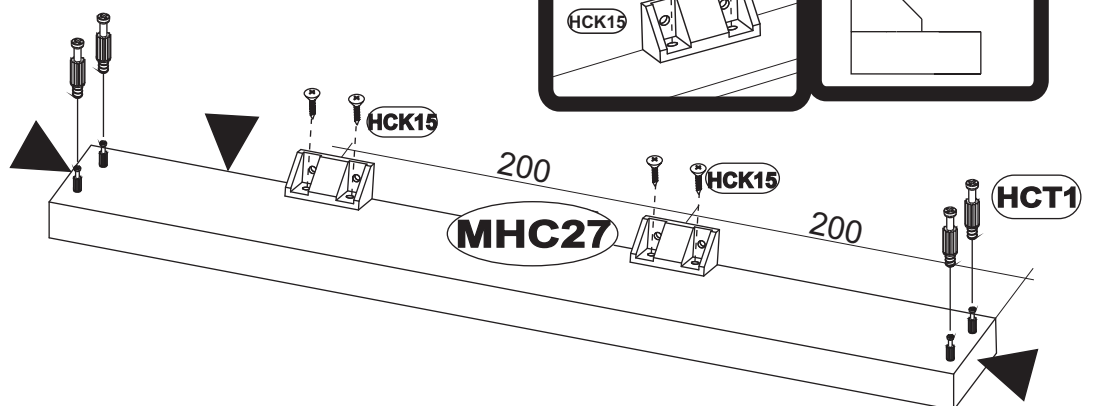
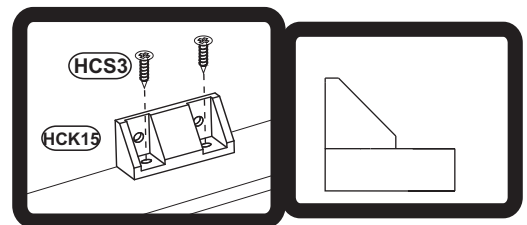
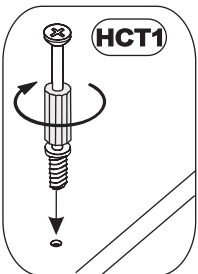
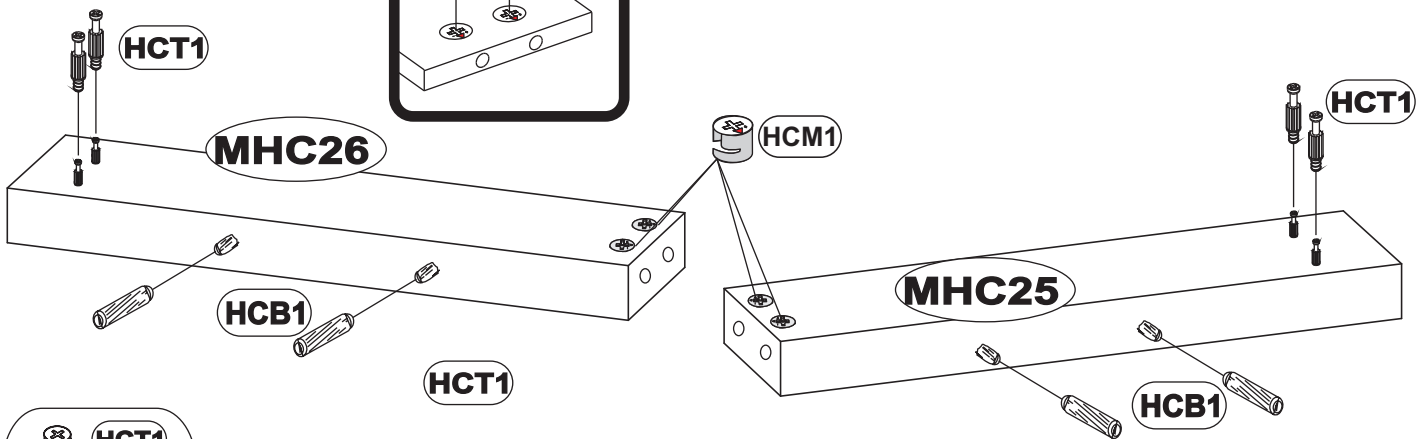
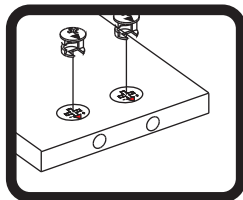
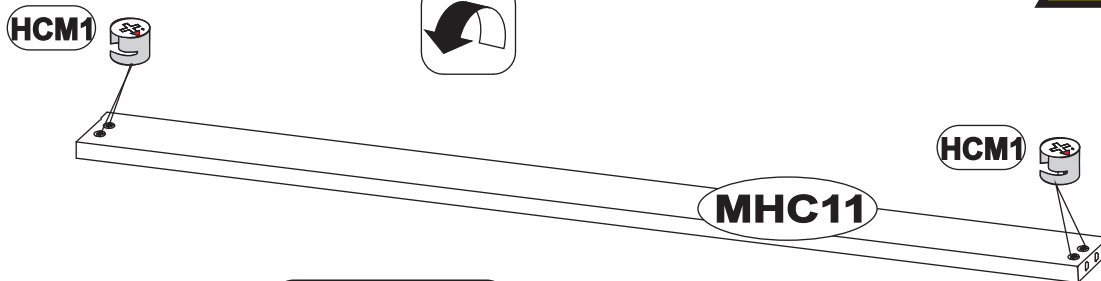
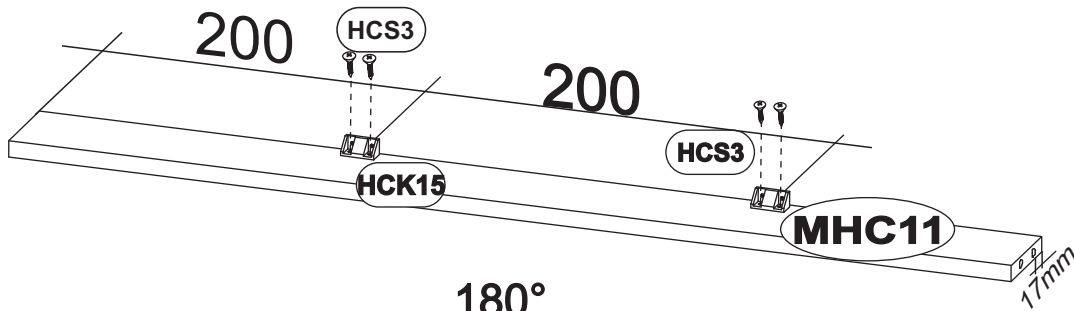



4

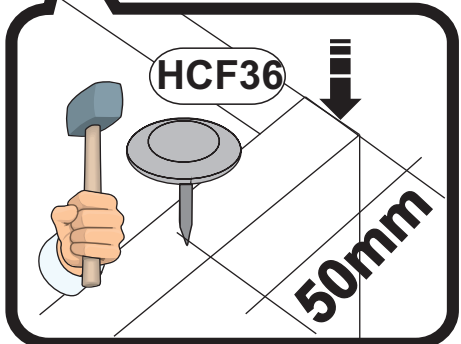
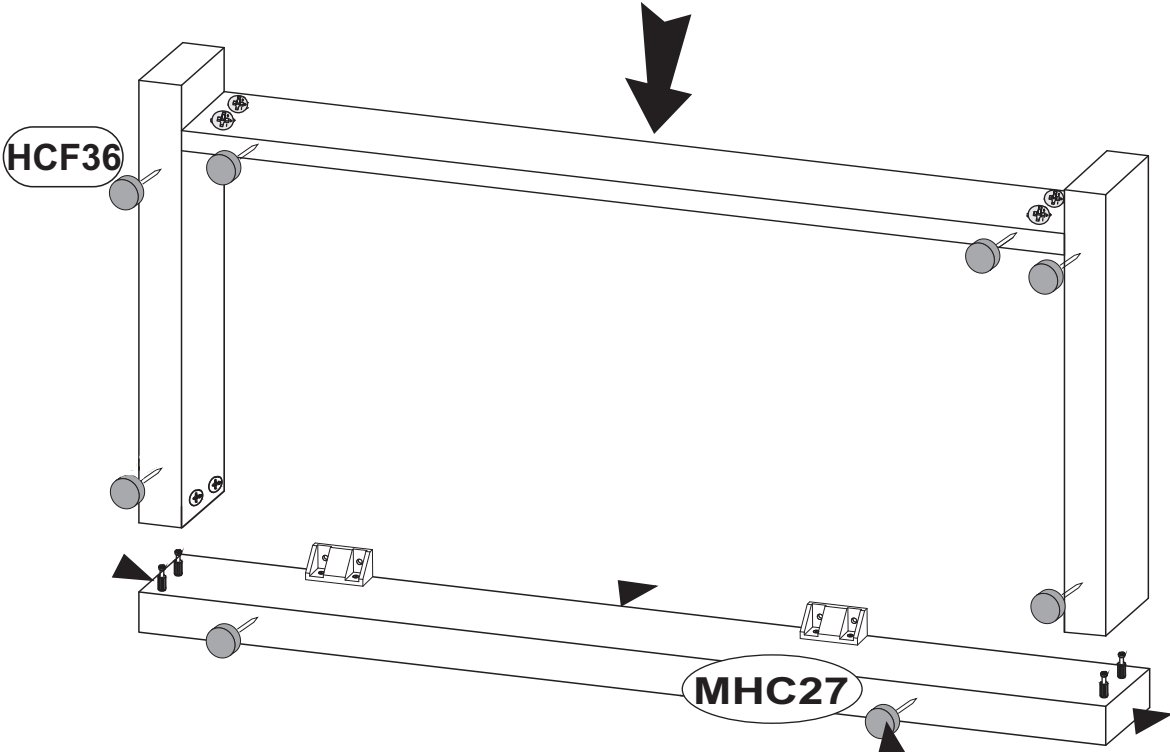
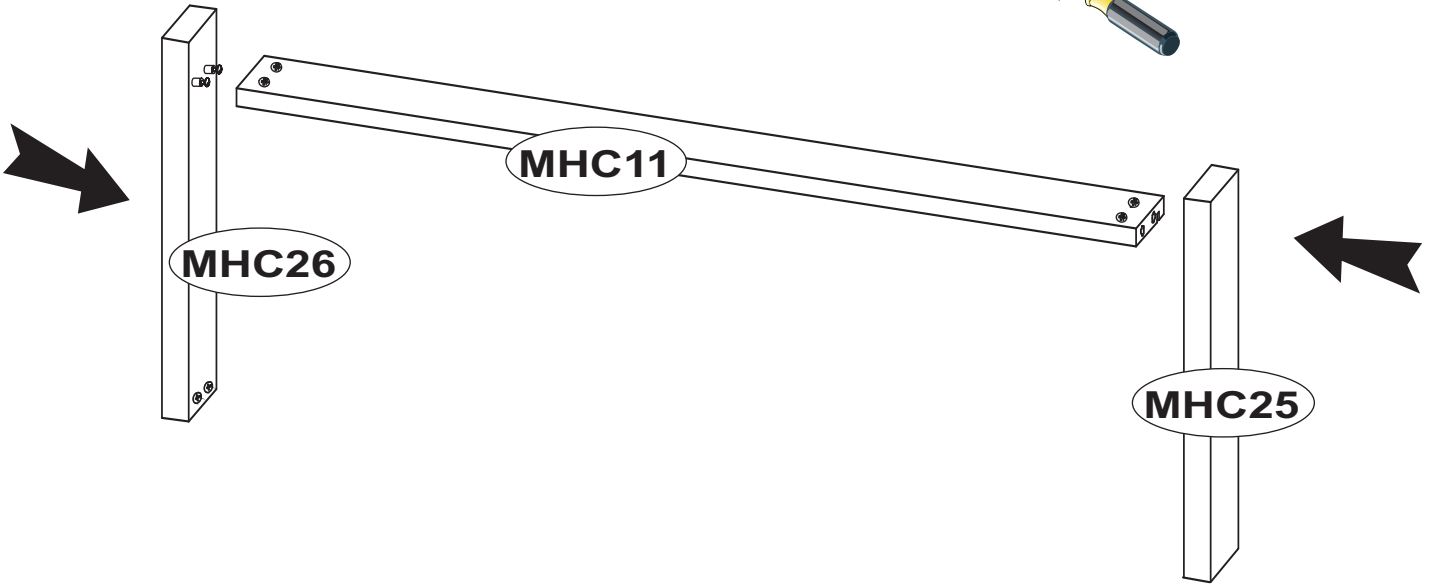
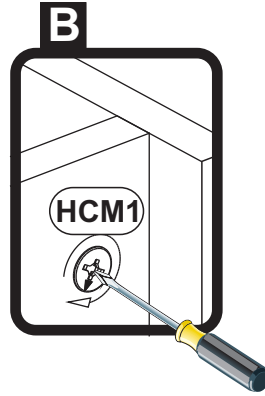
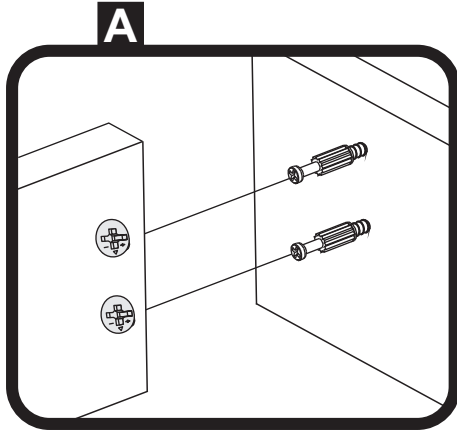

HCF36 1305
x8

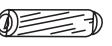

5

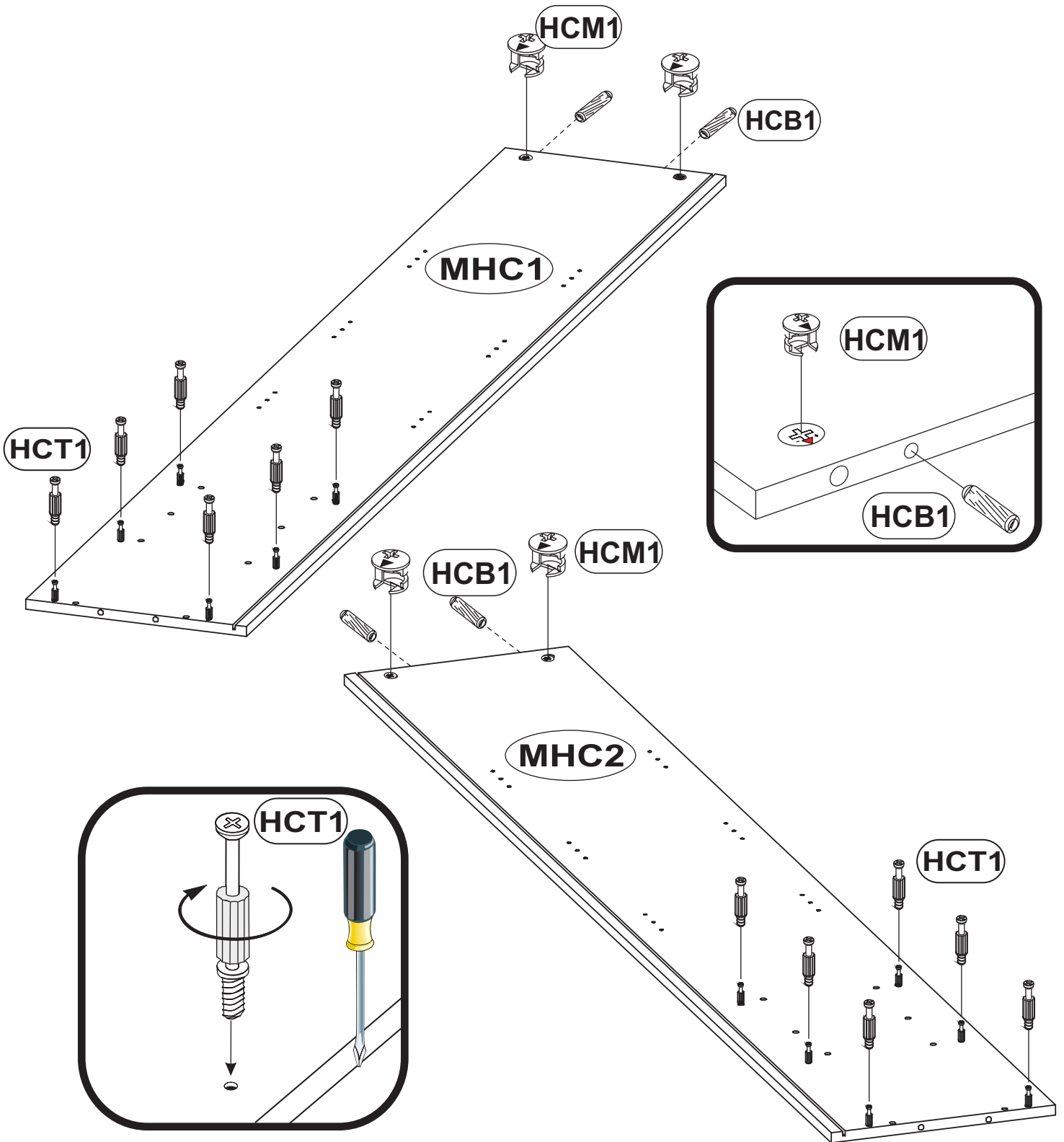
HCB1		1018
	8x28	x4
HCM1		123894
		x4
HCT1		11809
		x12



HCM1		123894
		x8
HCB1		1018
	8x28	x12

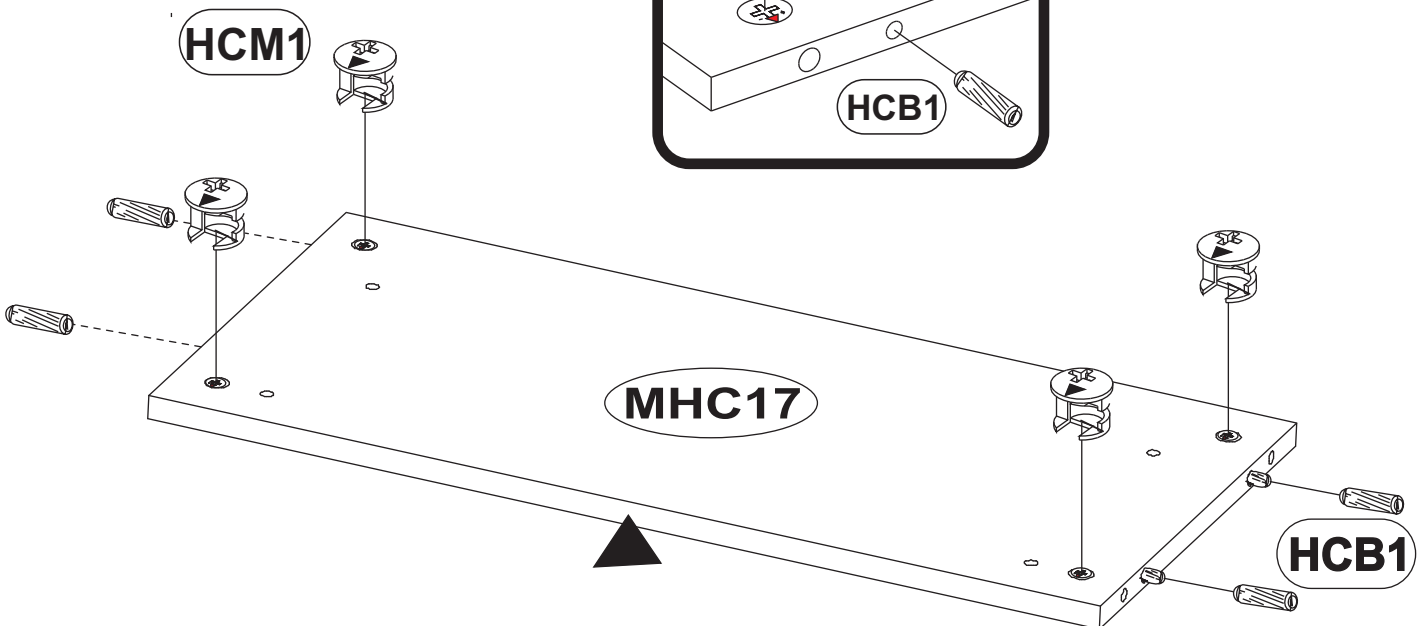
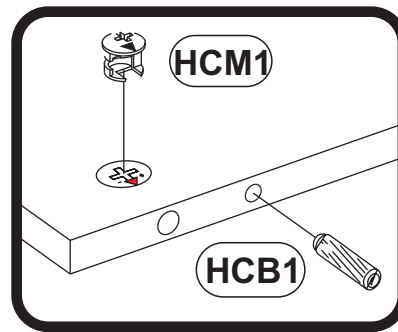
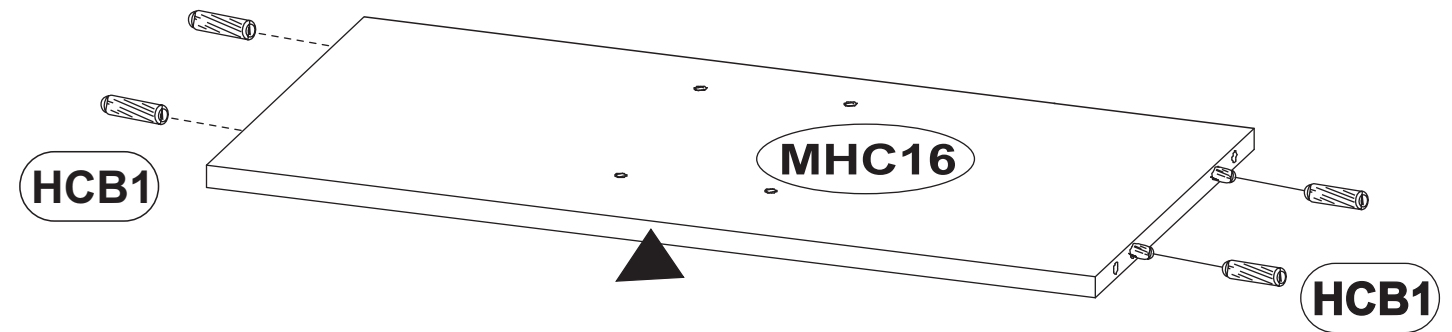
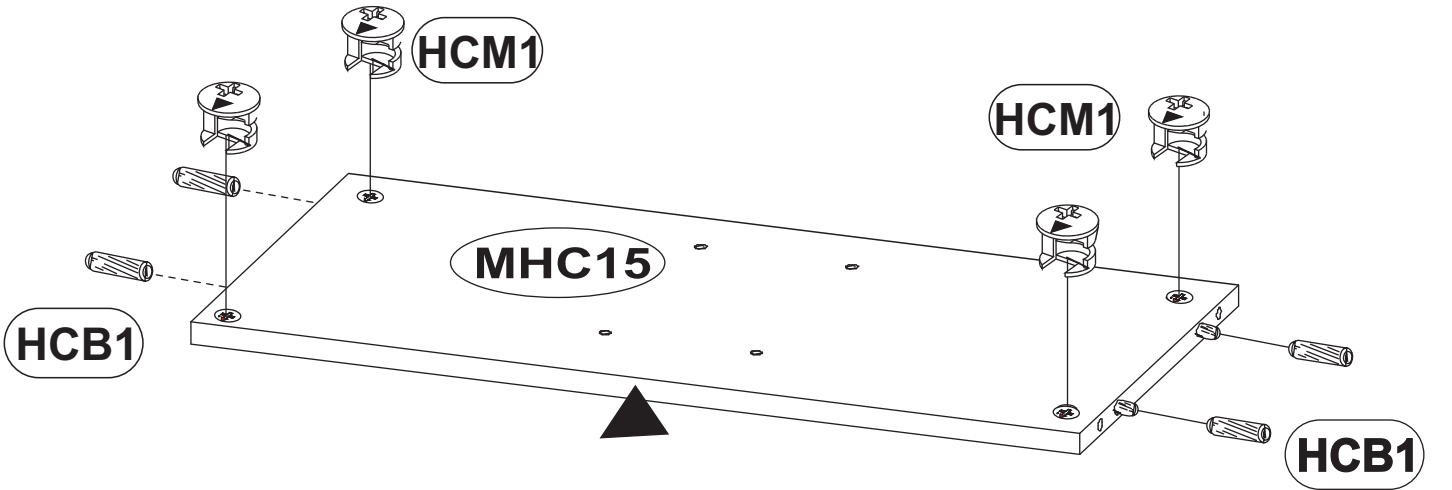
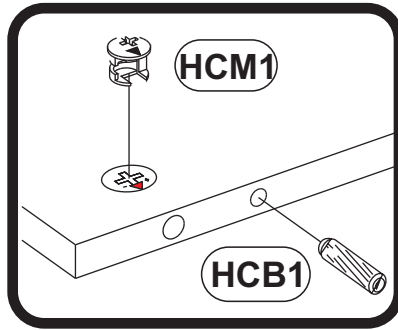

HCS3 1011
3,5x13 x4

HCM1 1336
x4

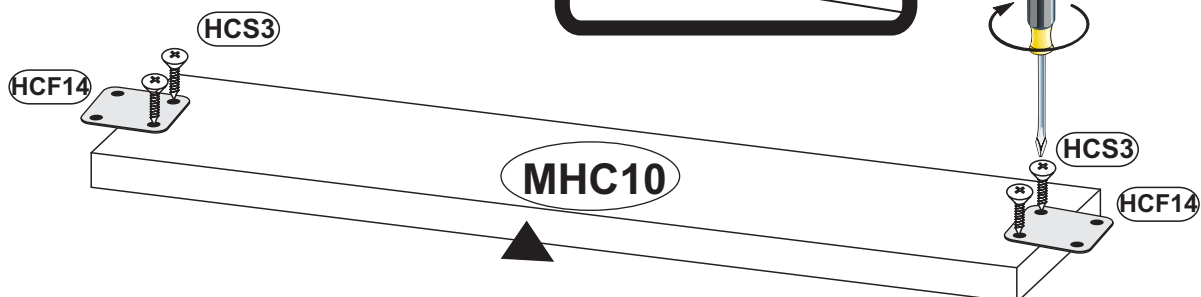
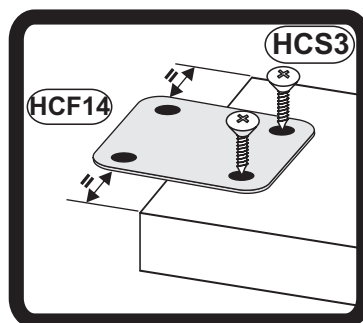
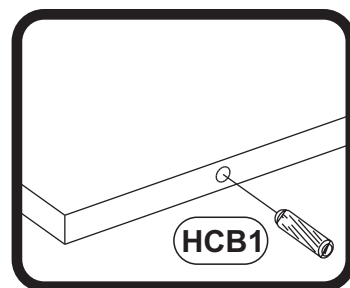
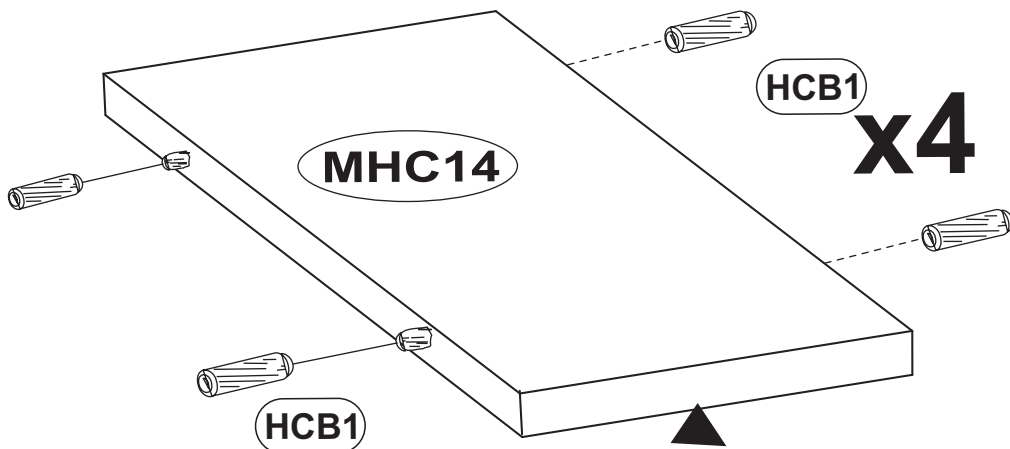
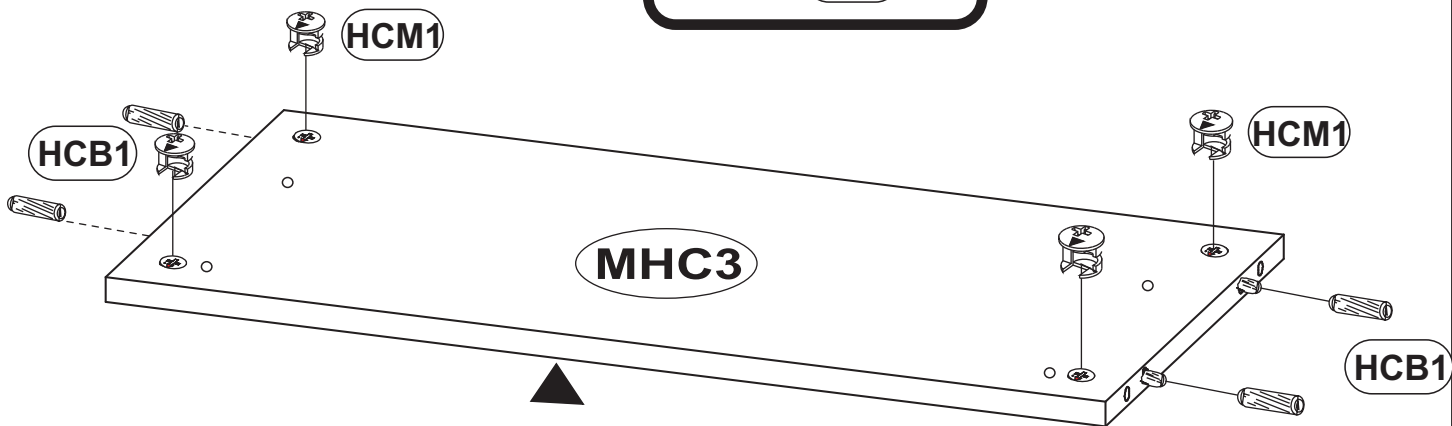
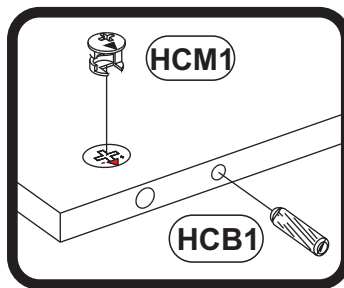

HCB1 1018
8x28 x20

HCF14 1021
x2



8

OPTION L

HCK13		49716
		x12
HCD14		23515
	H4	x3
HCS3		1011
	3,5x13	x24

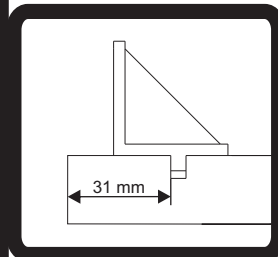
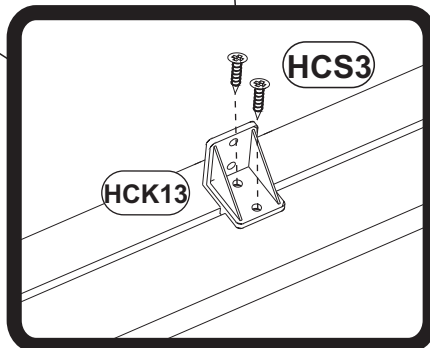
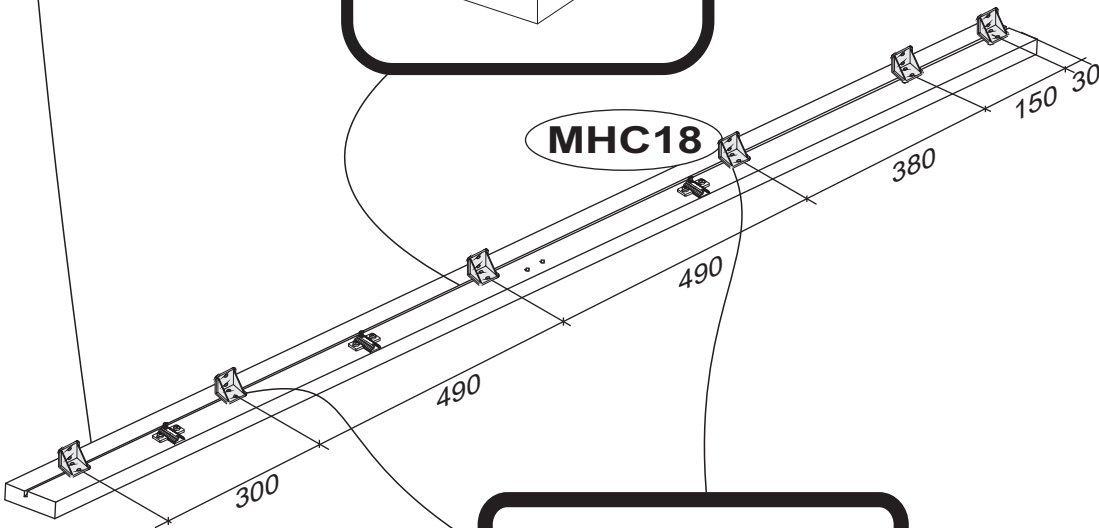
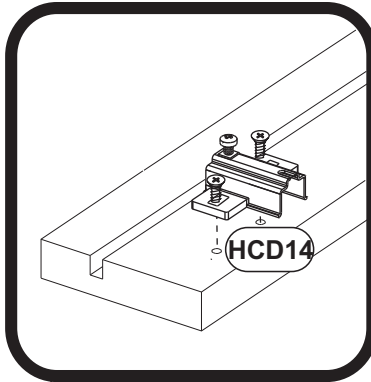
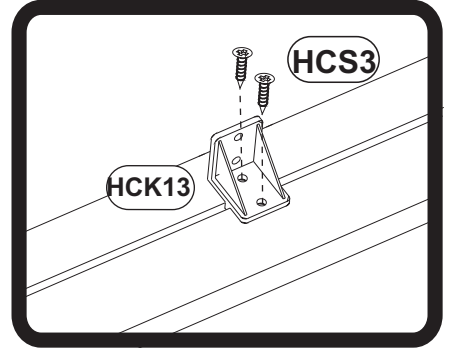
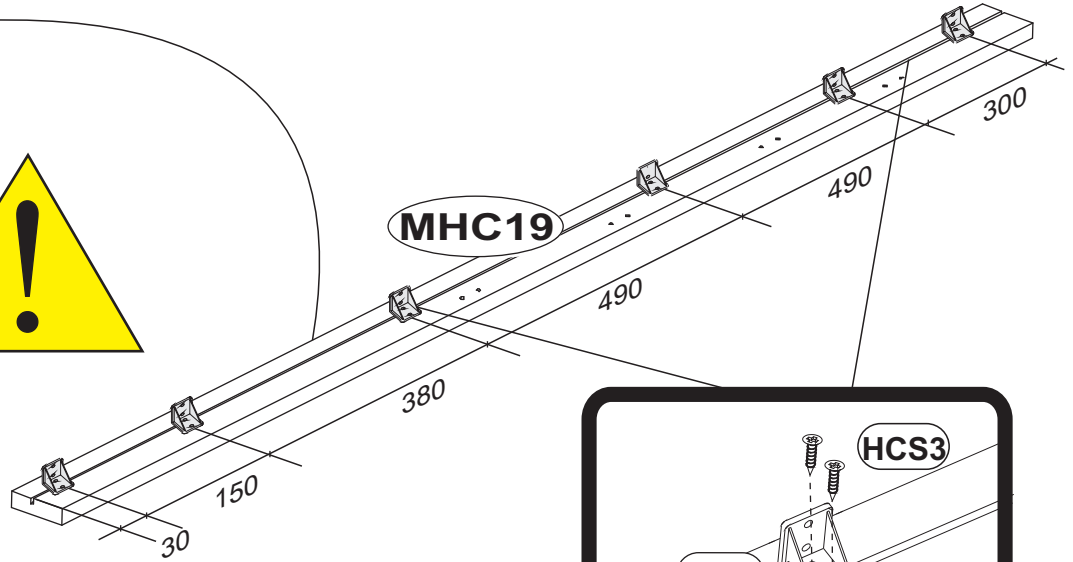
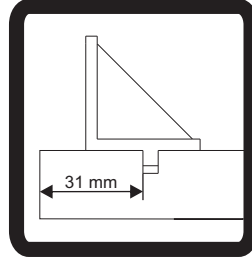
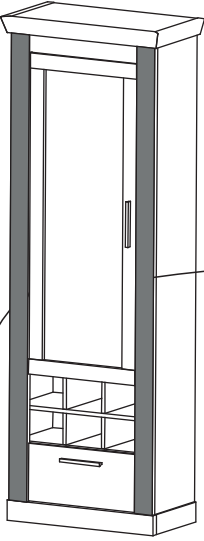

9

OPTION R



HCK13		49716	x12
HCD14		23515	x3
HCS3		1011	x24
		3,5x13	

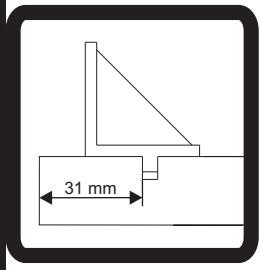
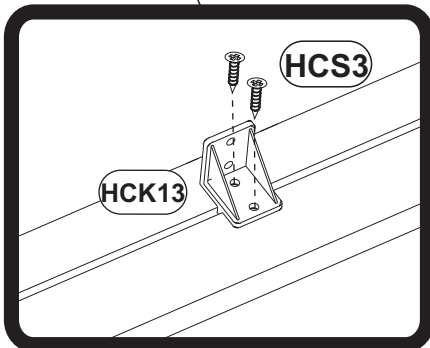
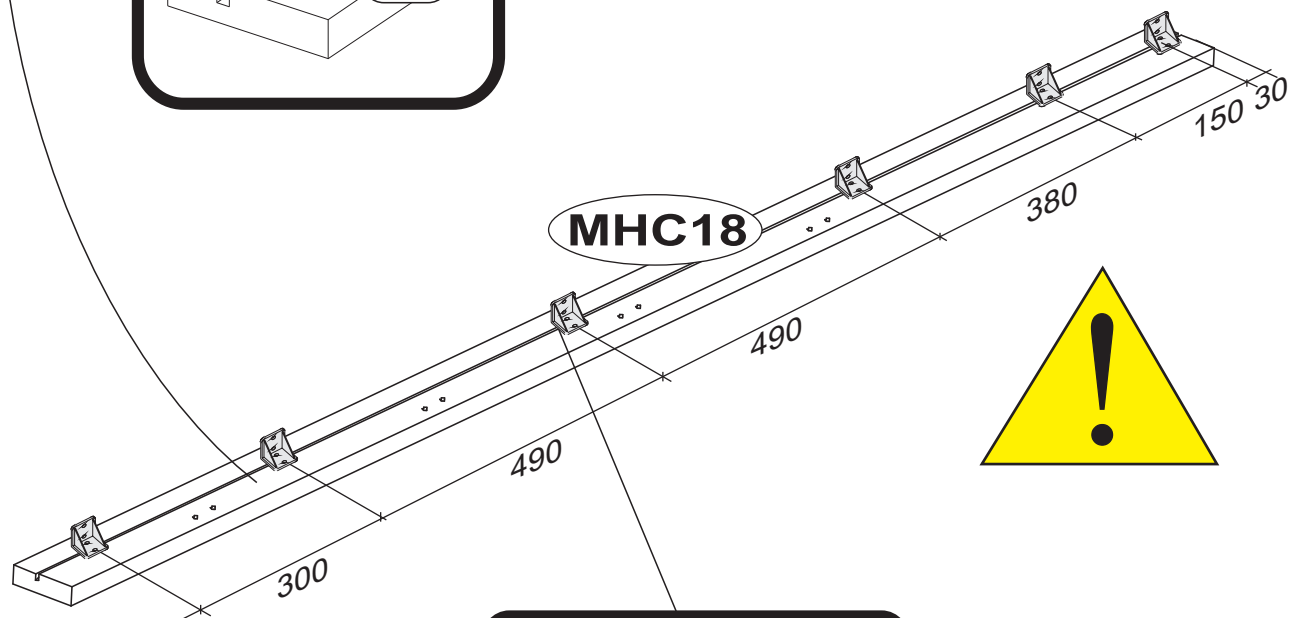
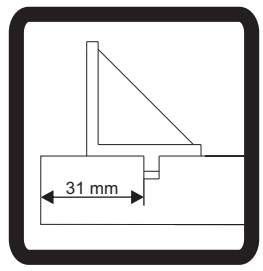
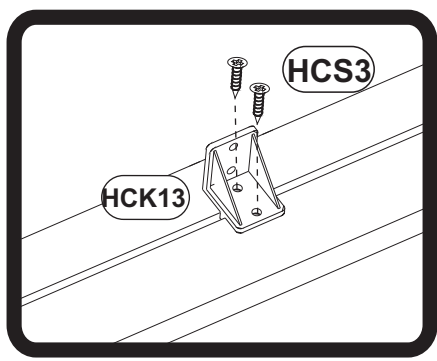
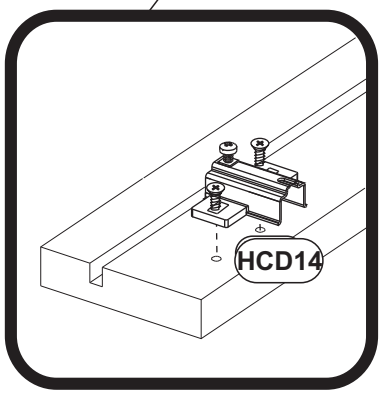
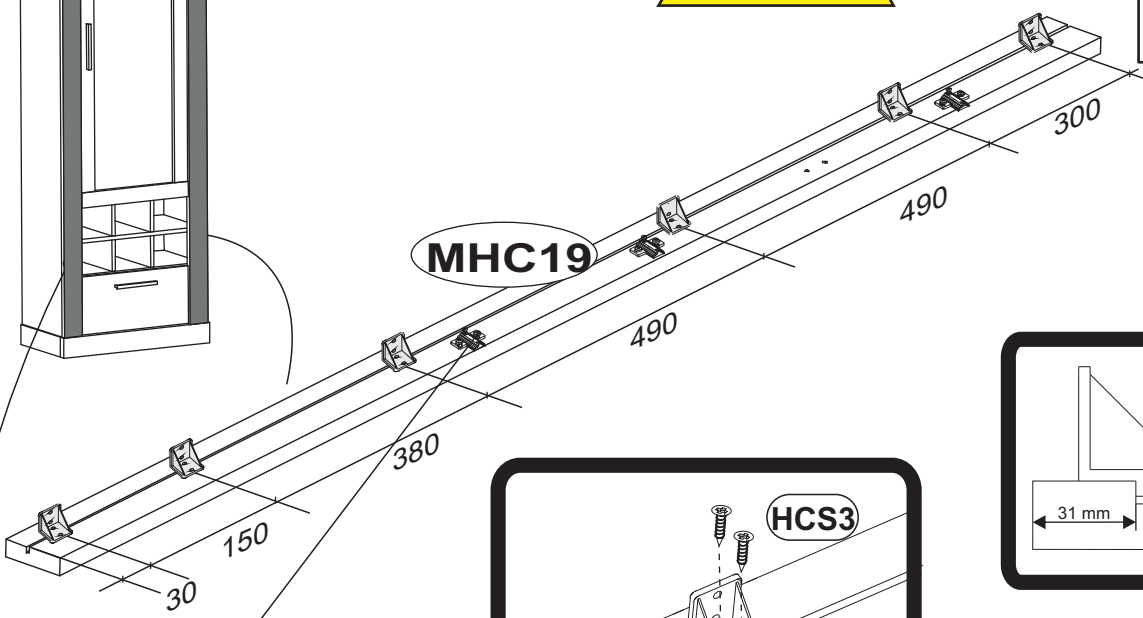
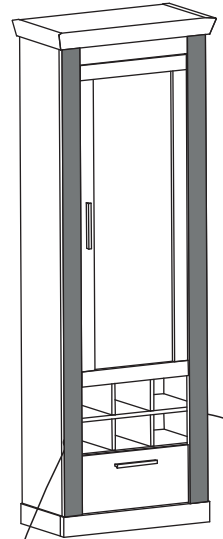

10

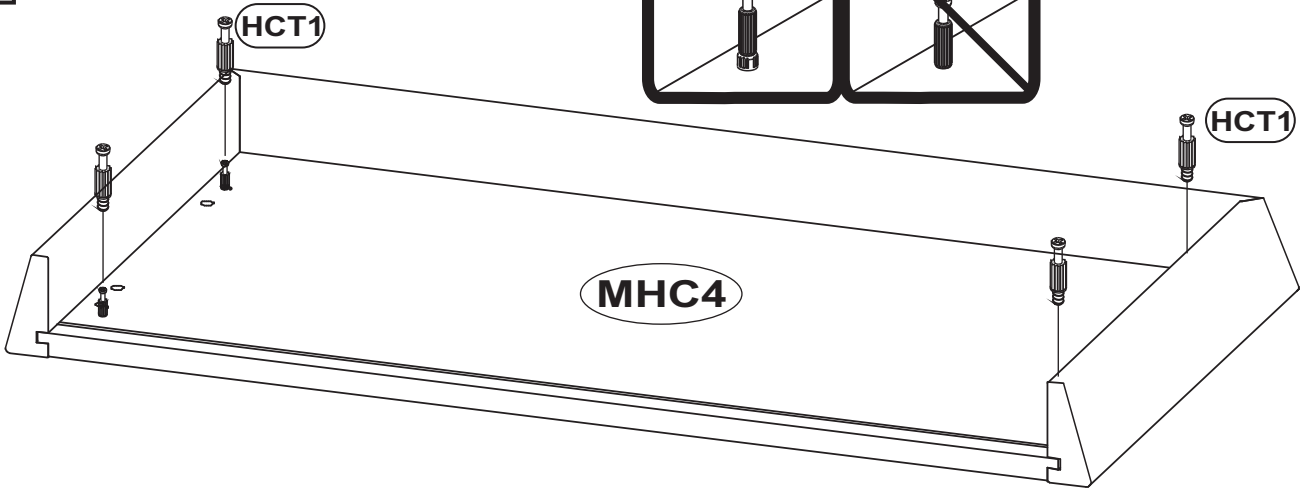
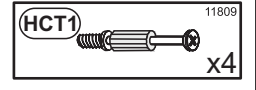
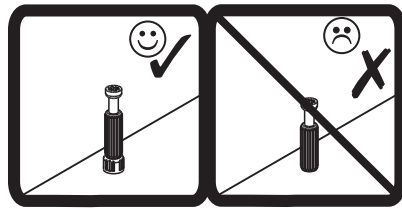

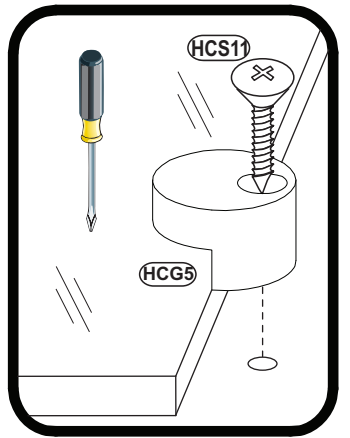
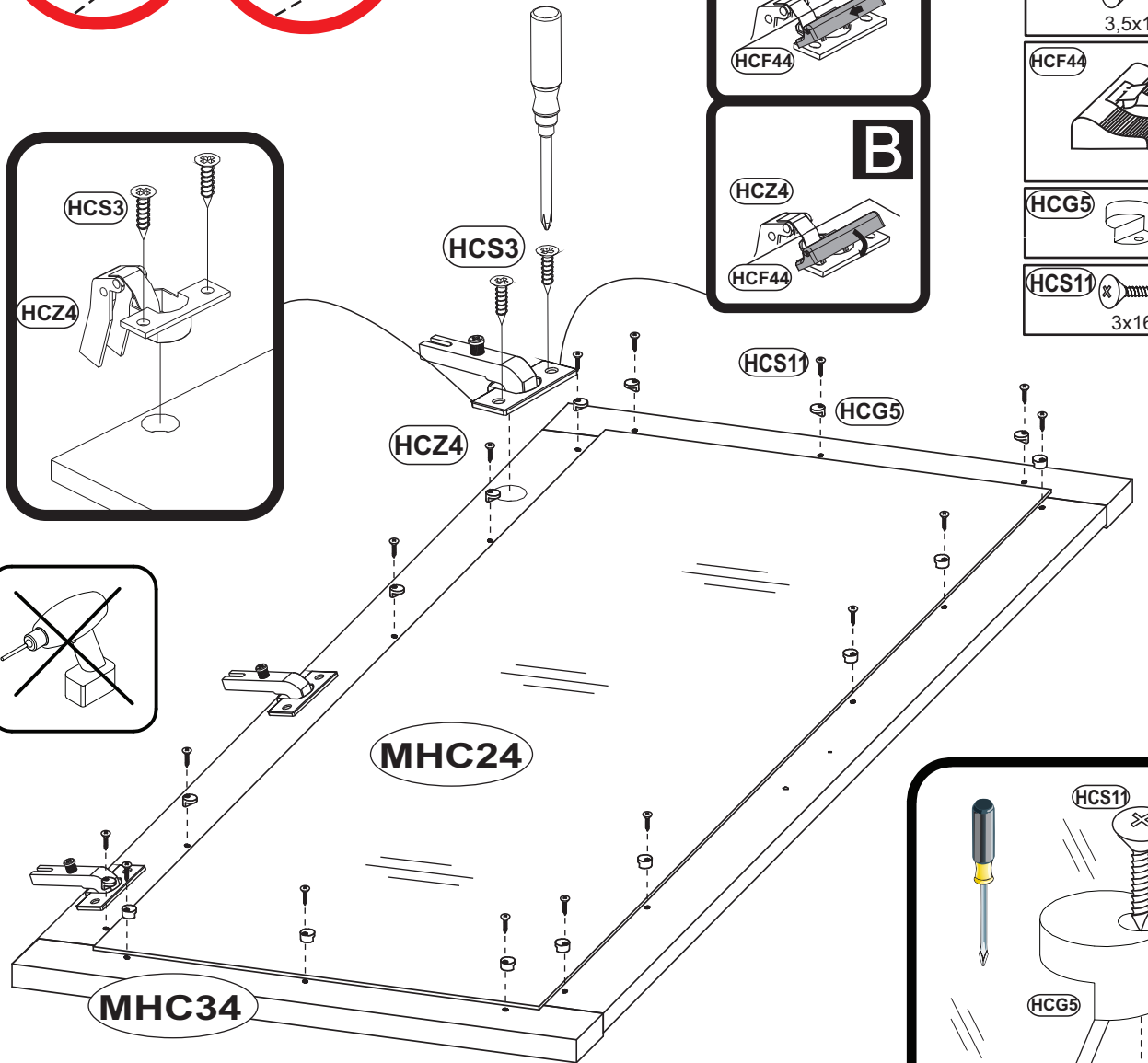
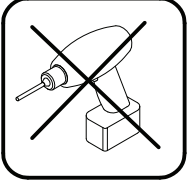
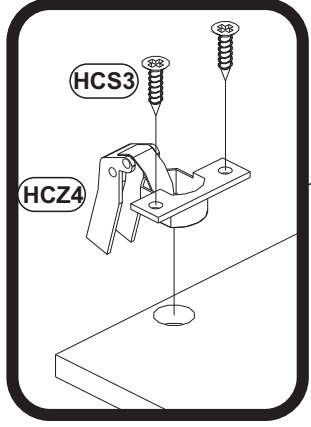
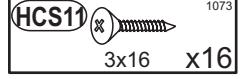
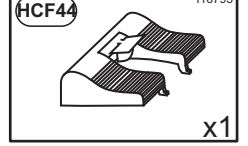
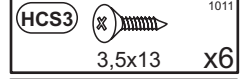
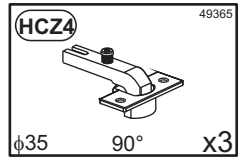
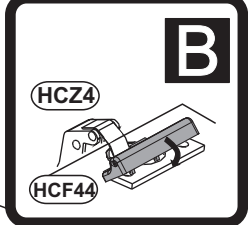
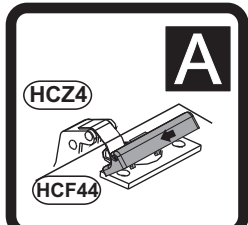
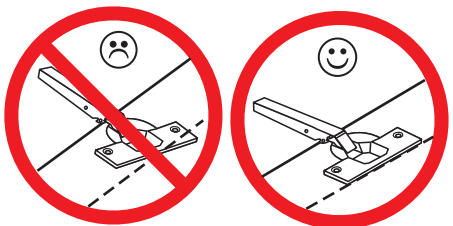

11

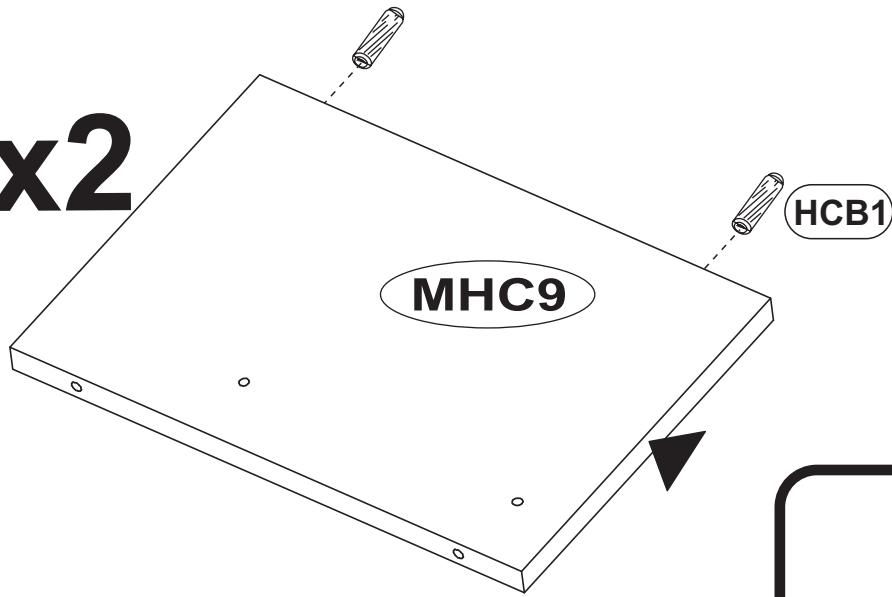

x2

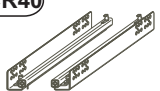

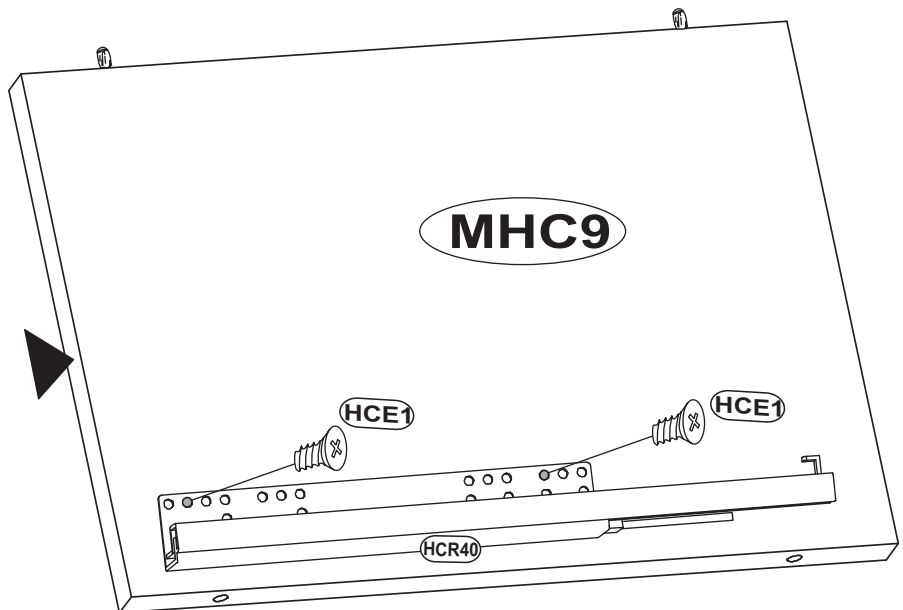
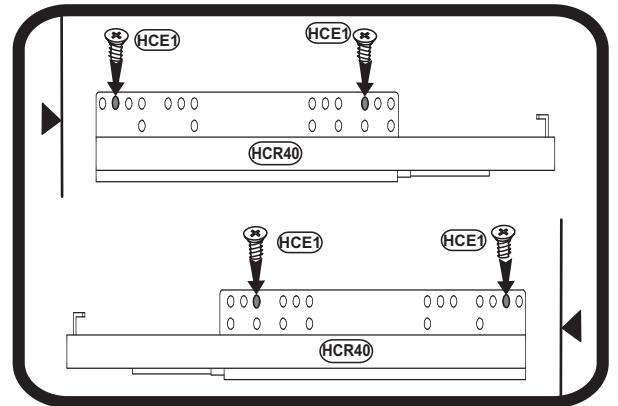
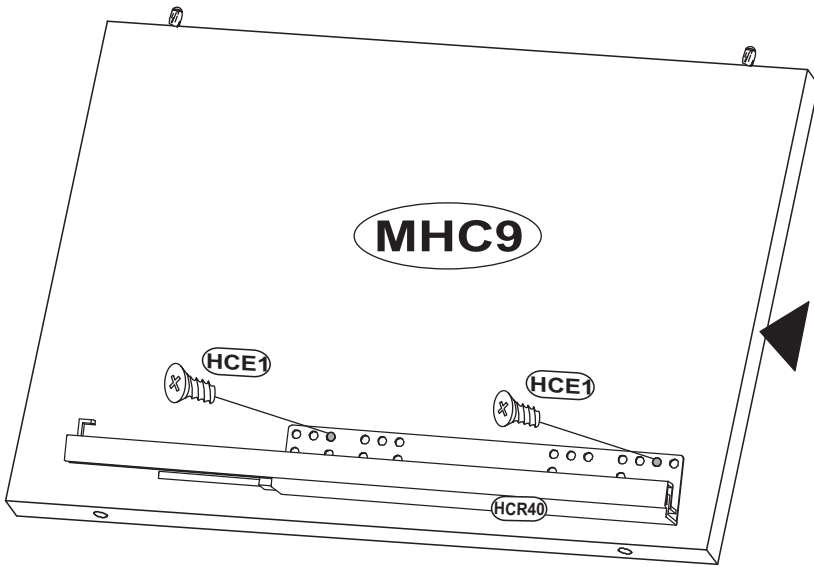
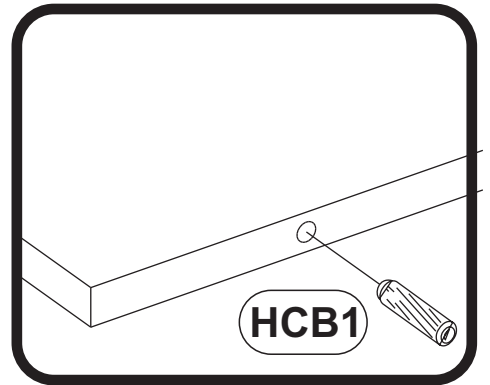

HCB1		1018
	8x28	x4
HCR40		60497
	250	x1
HCE1		1008
	ES 6,3x9,5	x4

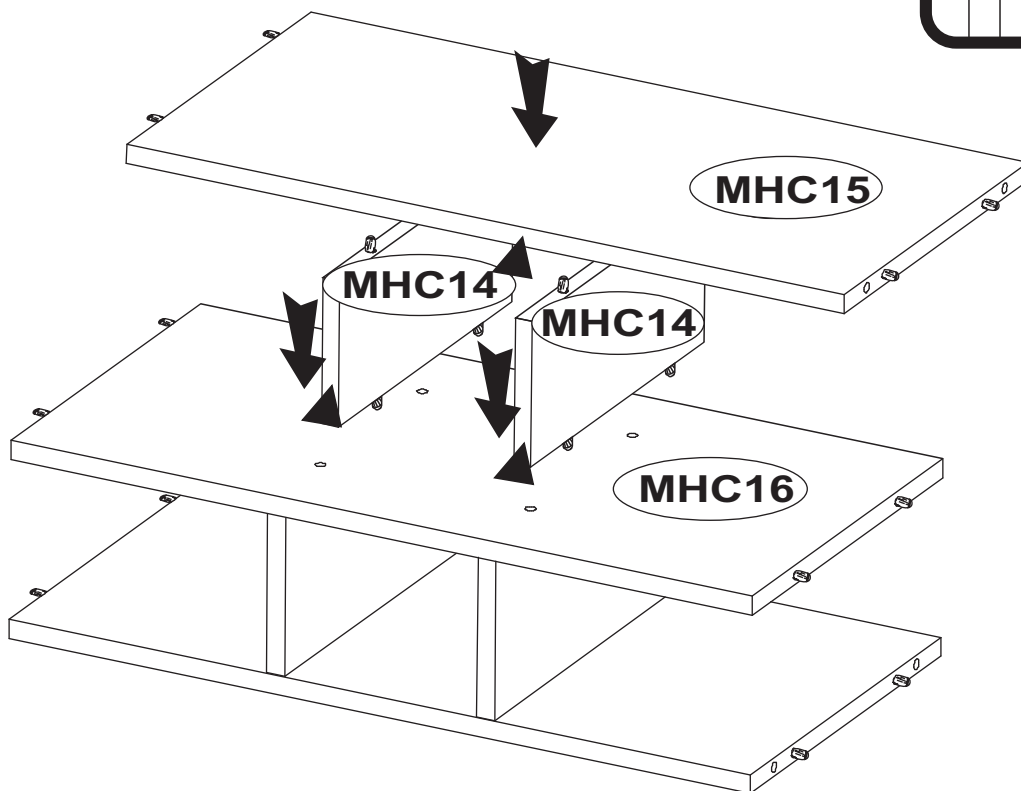
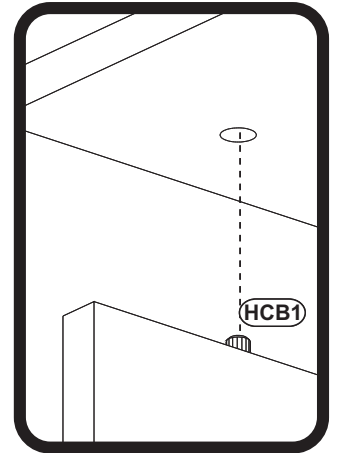
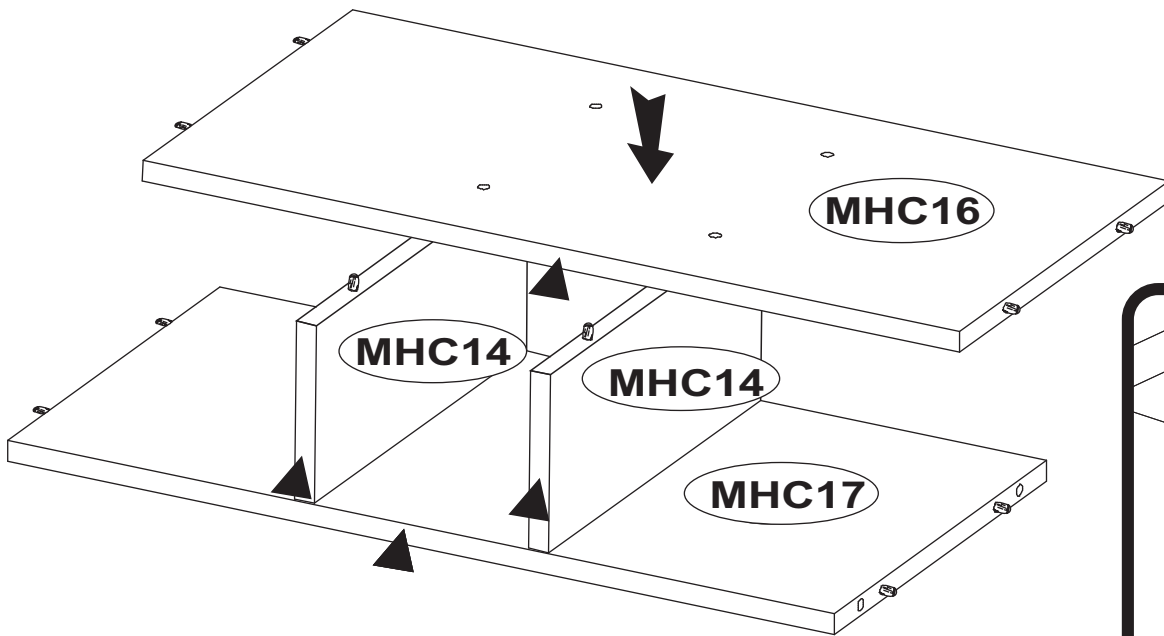
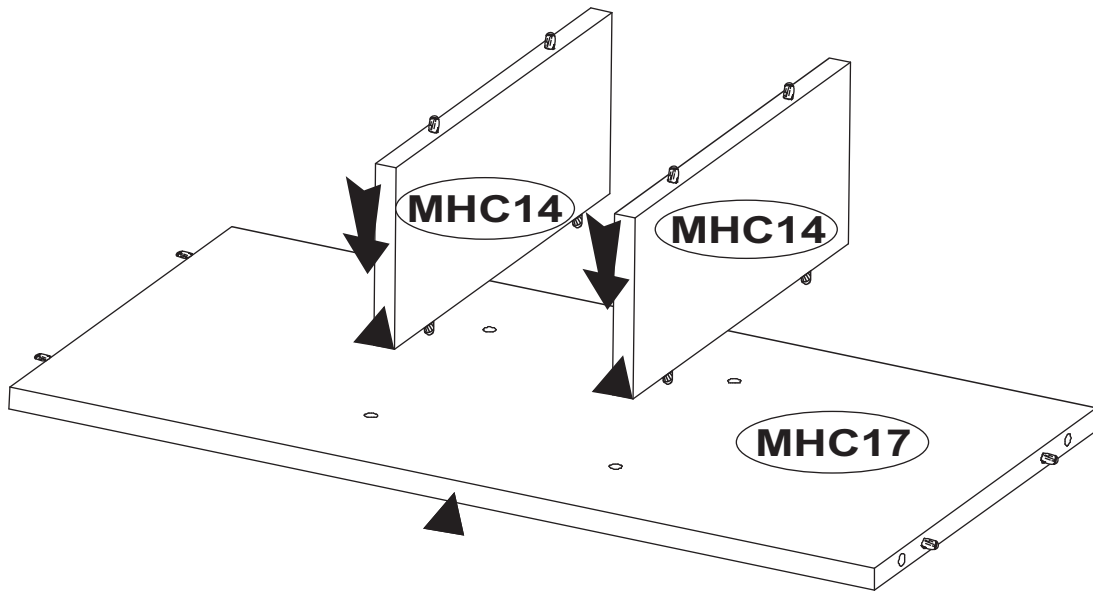

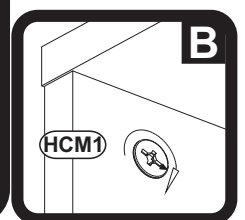
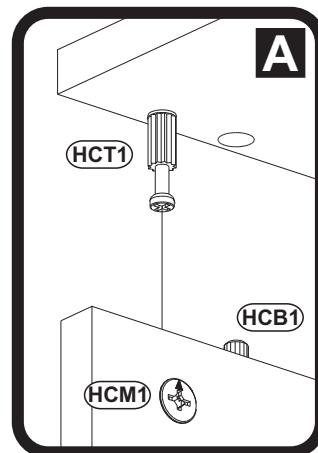
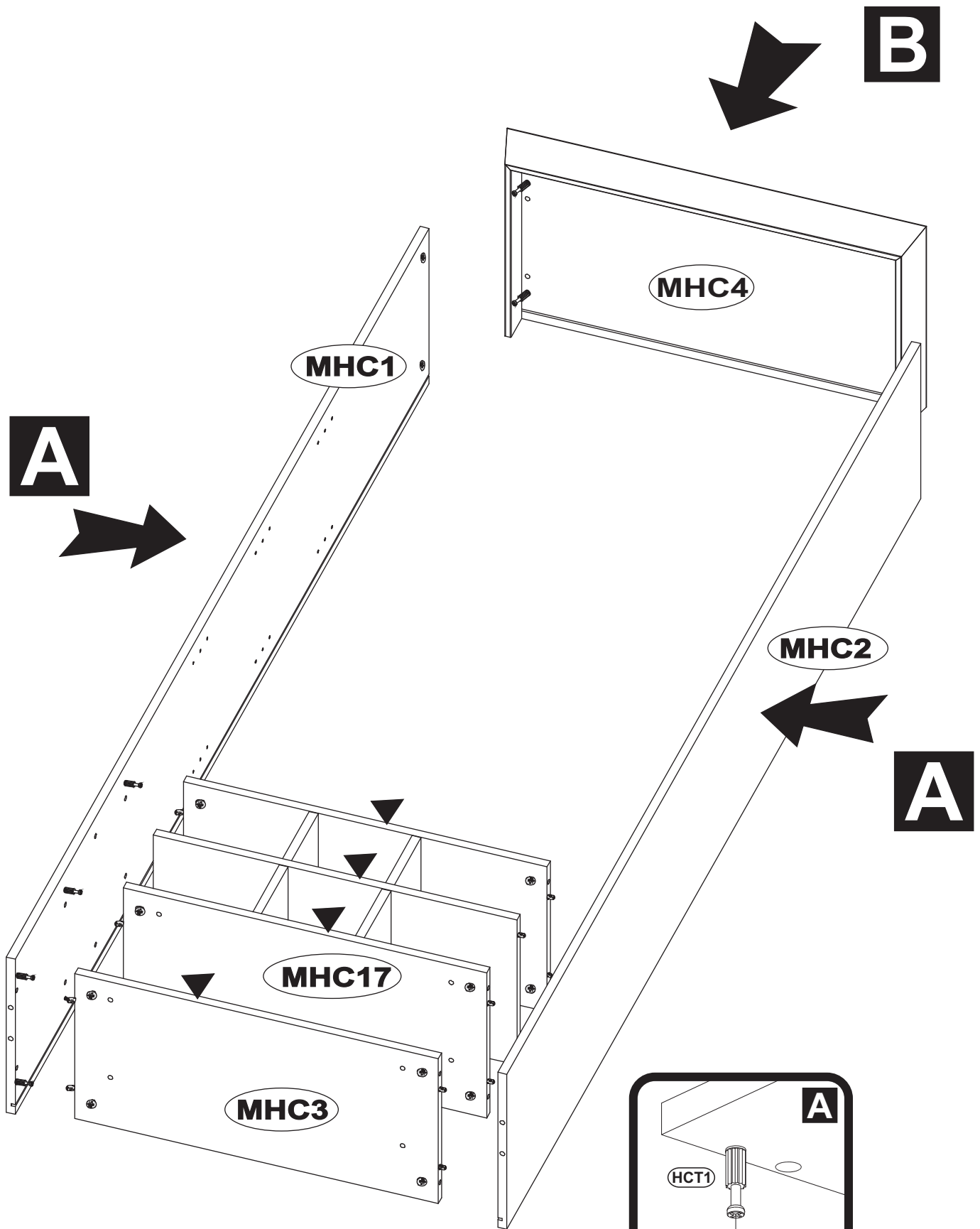



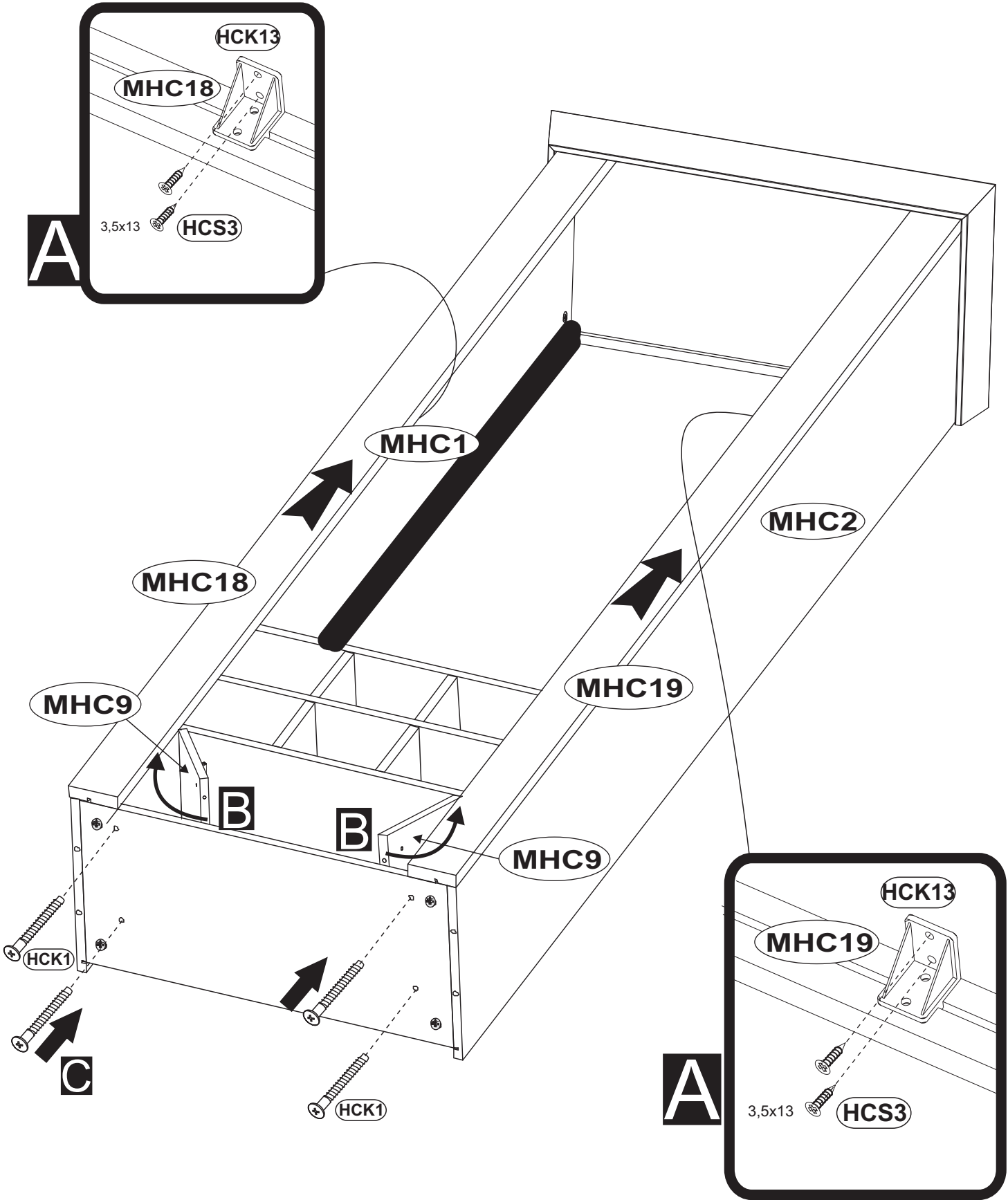

HCS3		1011
	3,5x13	x24
HCK1		1354
	7x50	x4

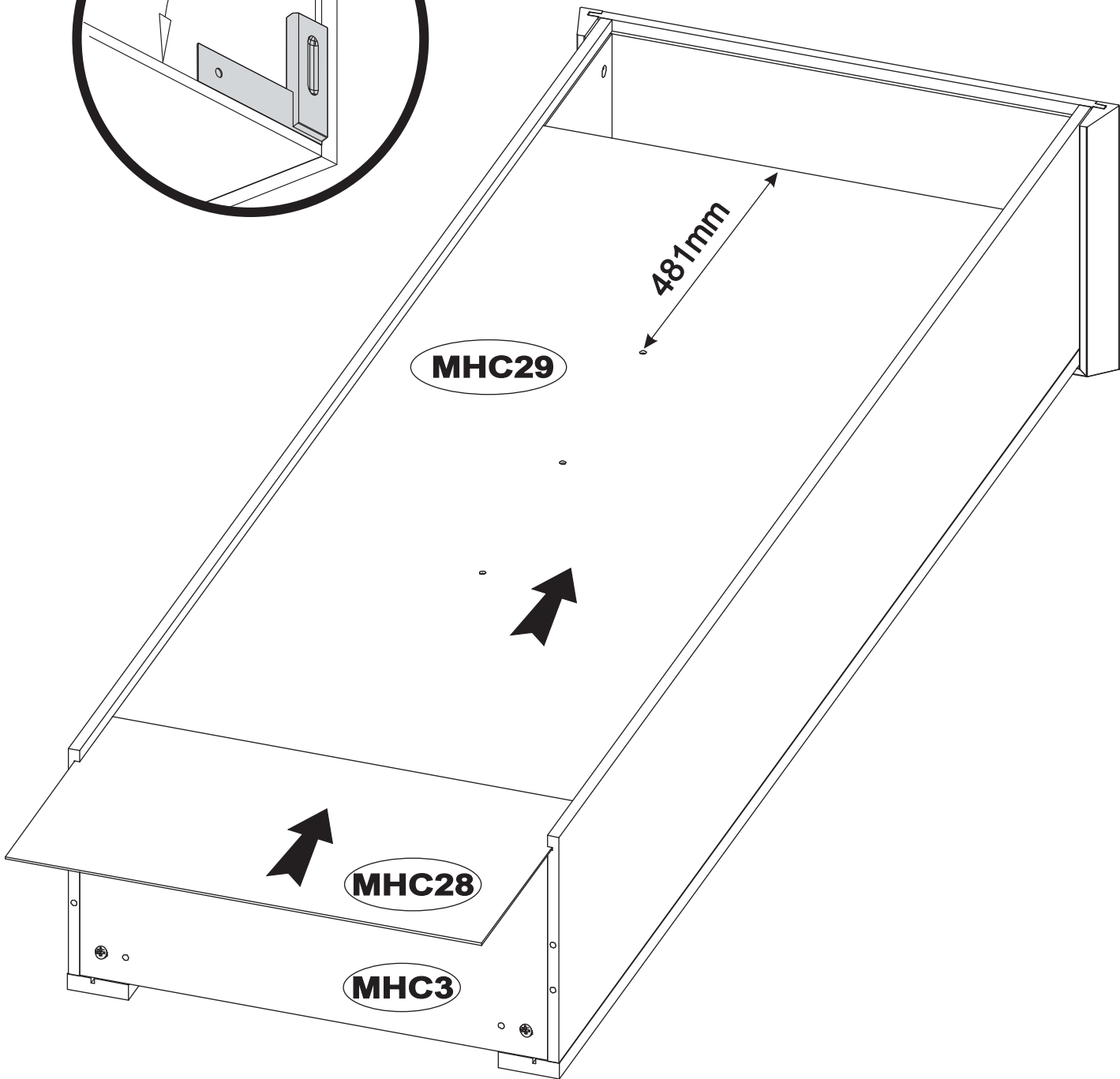
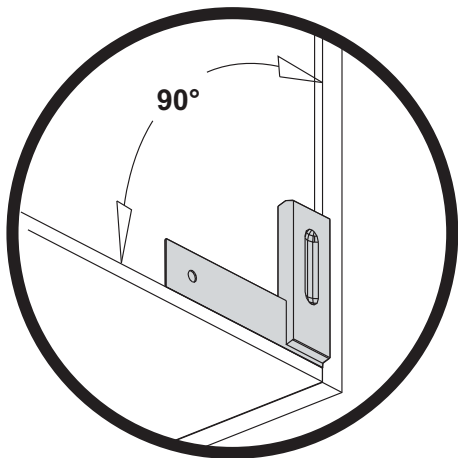







HCS3		1011
	3,5x13	x8

HCJ23		1302
		x14

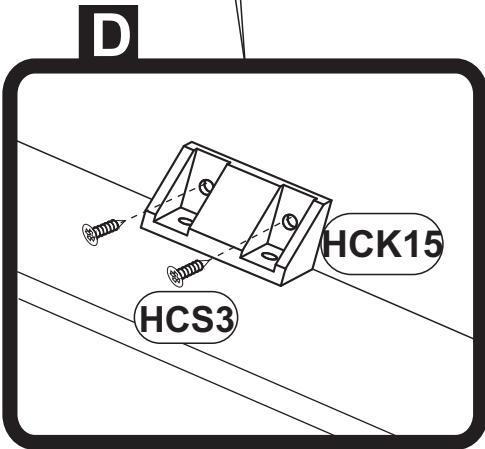
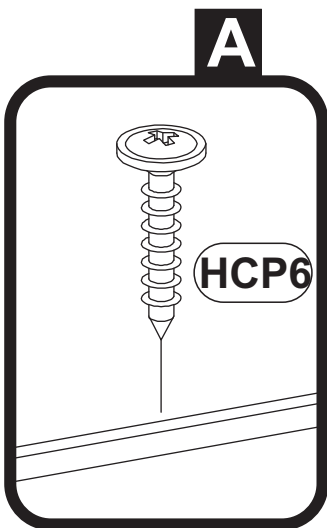
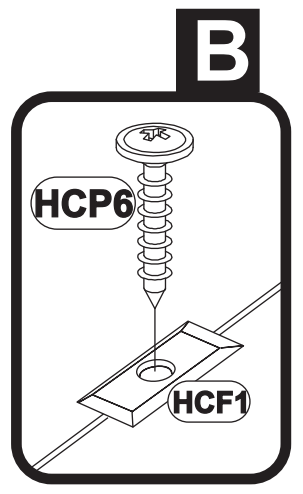
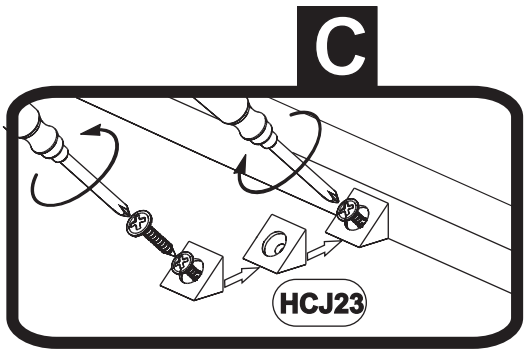
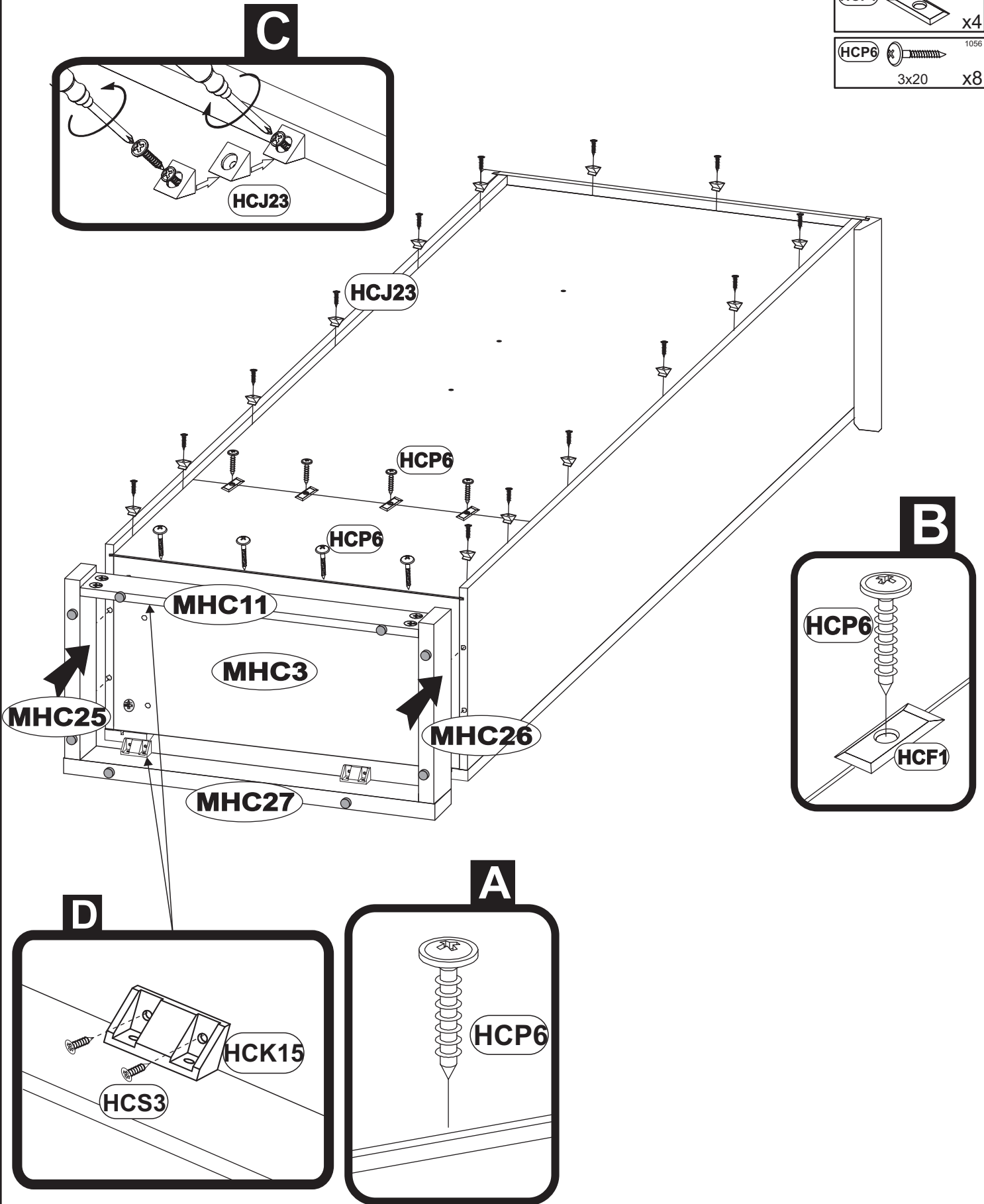
HCF1		1415
		x4

HCP6		1056
	3x20	x8



HCS3		1011
	3,5x13	x4
HCW2		1290
		x12
HCJ11		1267
		x1

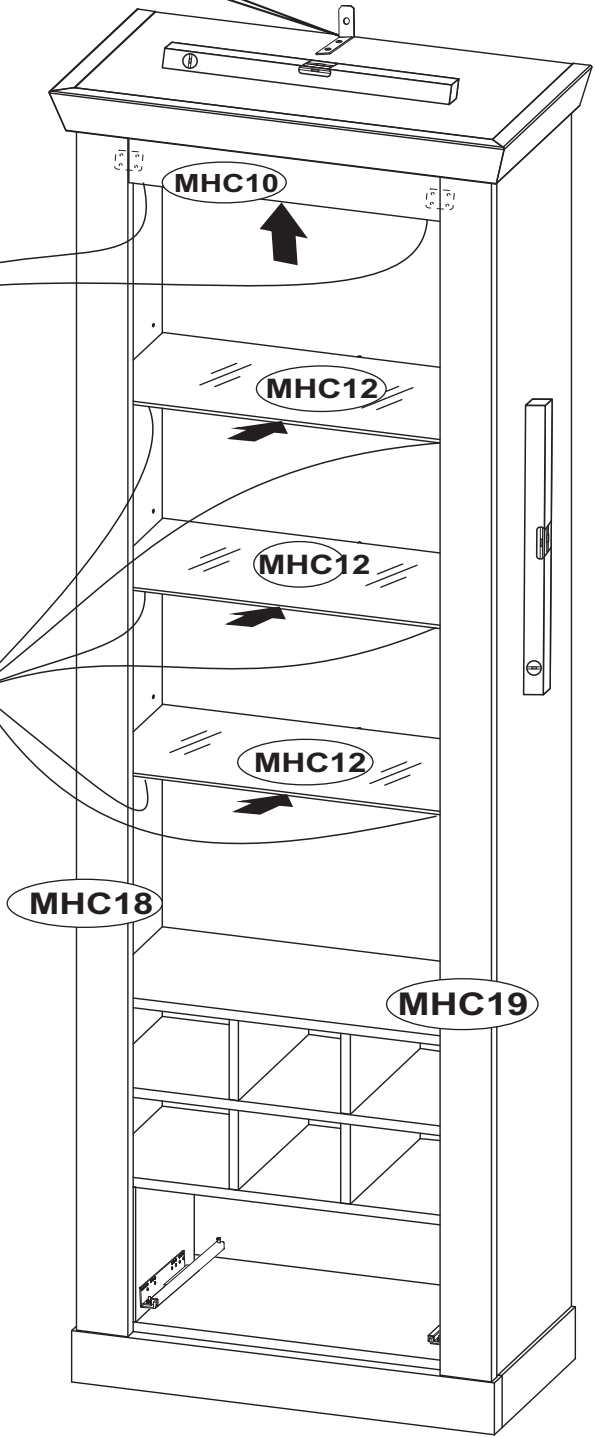
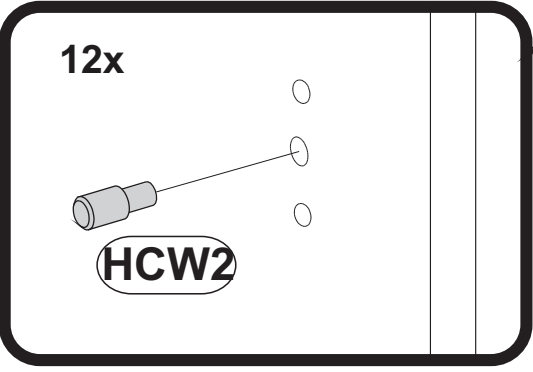
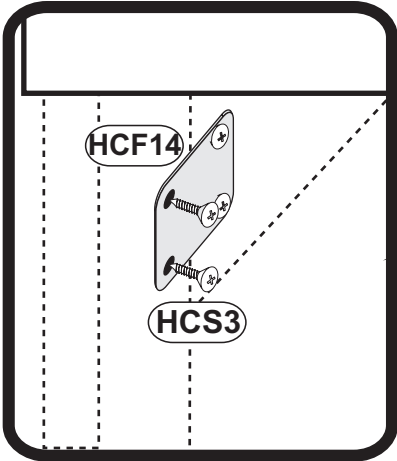
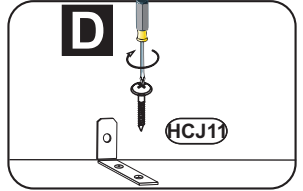
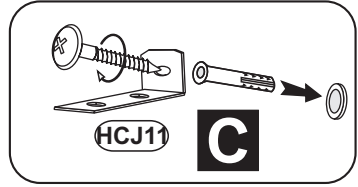
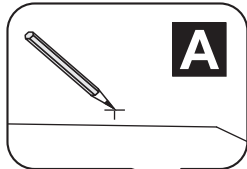
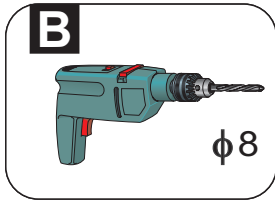



HCA6		2549	x4
HCU4		133907	x2
HCG54		126680	x1
HCP2		1014	x1
HCC6		00000	x8

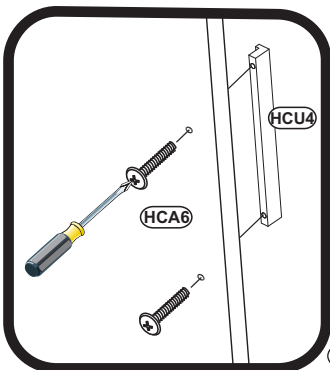

MHC34

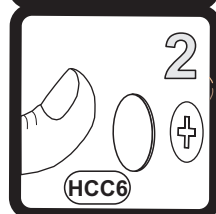
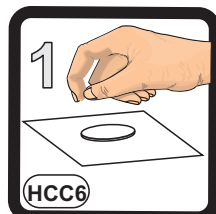
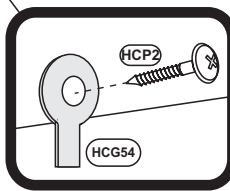

MHC19

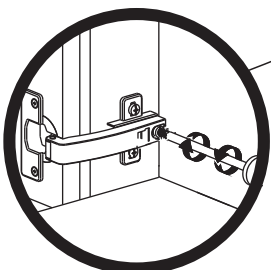

MHC18

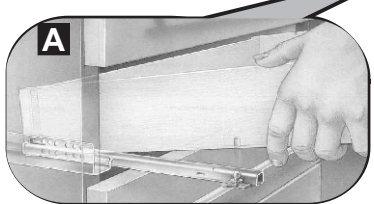
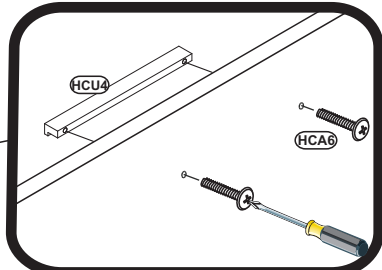

A

MHC30

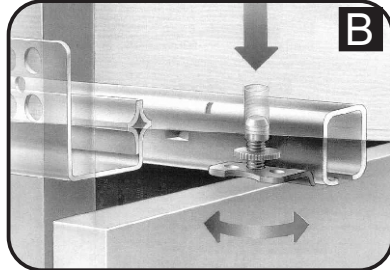

B

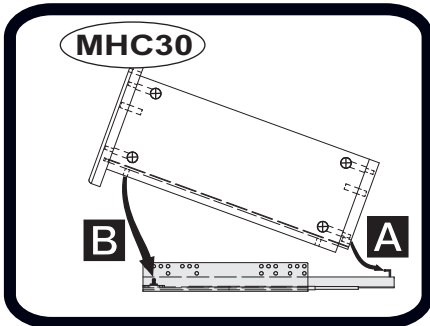

MHC30

B

A

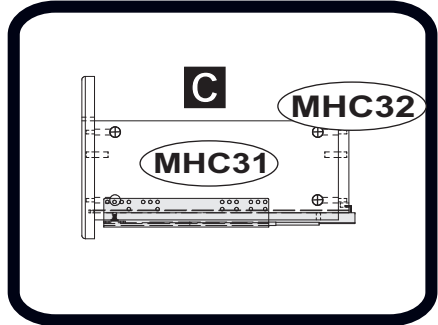



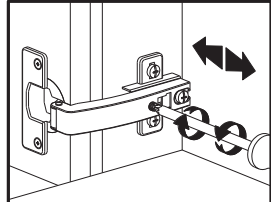
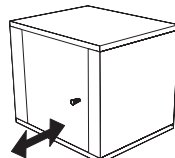
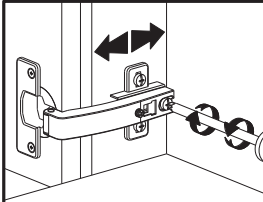
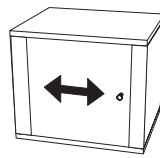
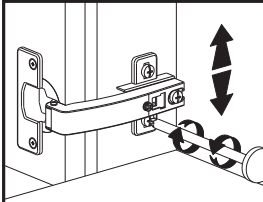
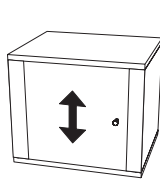

C

MHC31

MHC32



HCA6		2549
	WPM 4x22	x4
HCU4		133907
	L-160	x2
HCG54		126680
		x1
HCP2		1014
	3,5x13	x1
HCC6		00000
	φ20	x8

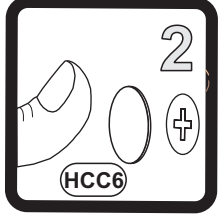
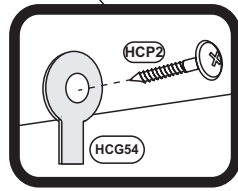
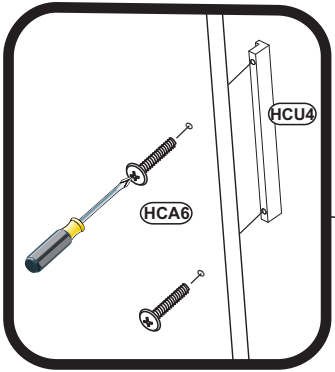

MHC18

MHC34

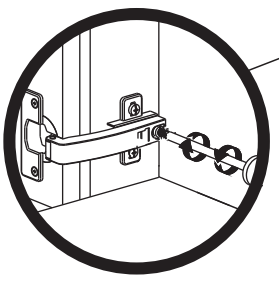

MHC19

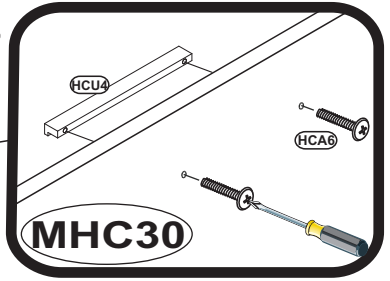

MHC30

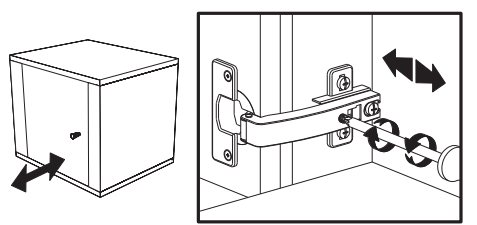
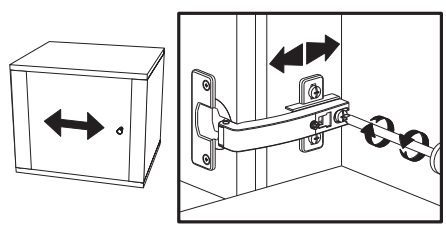
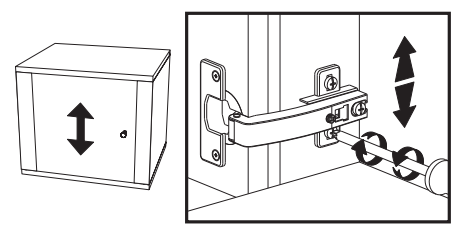
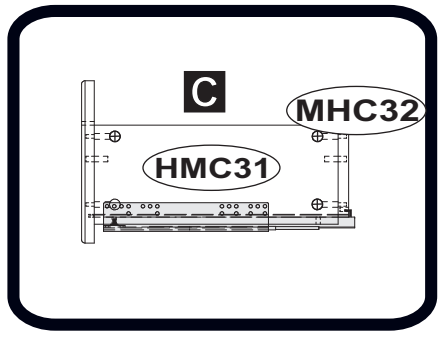
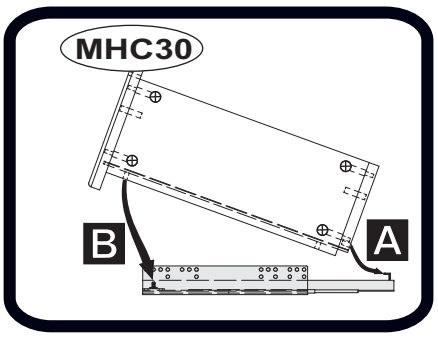
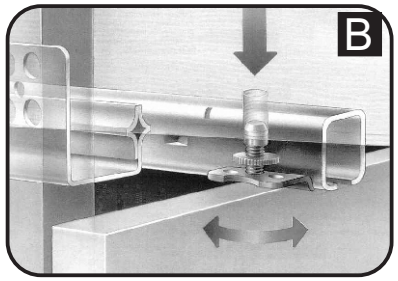
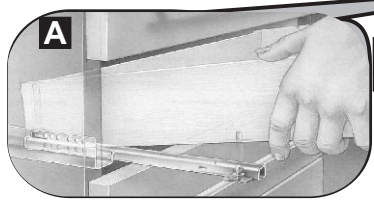

SIENA 23M

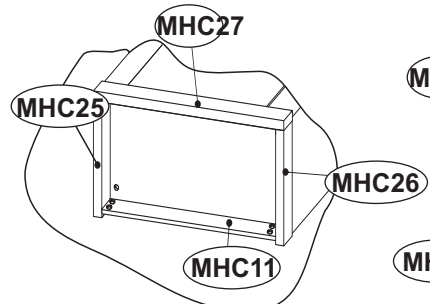
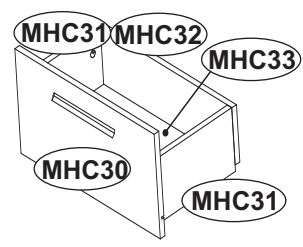
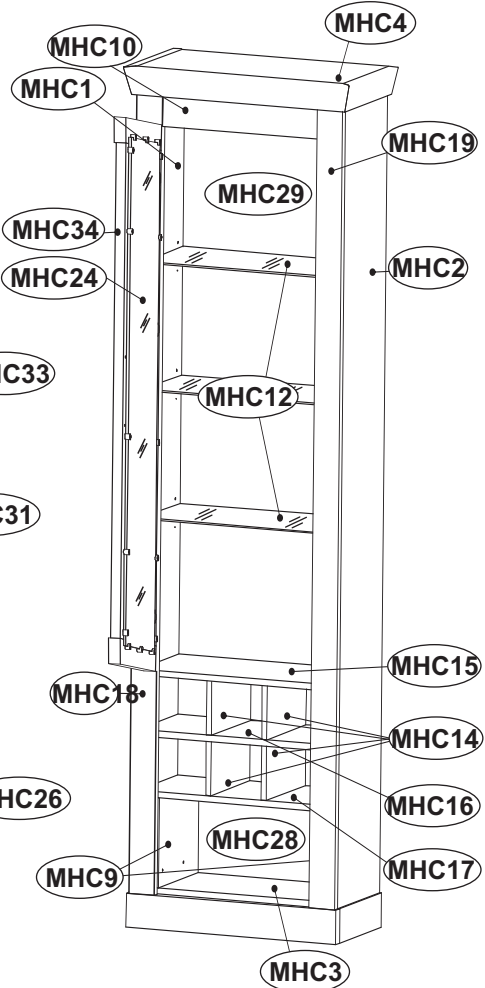

D Unser Direktservice für Beschlagteile
Sollte Ihnen ein Beschlagteil fehlen, können Sie diese Servicekarte direkt an die untenstehende Adresse mailen. Wir können allerdings nur Beschlagteile auf diesem Wege verschicken. Sollten Sie eine andere Beanstandung an Ihrem Möbelstück haben, so wenden Sie sich bitte direkt an Ihr Möbelhaus.

GB Our direct order service for fittings
If a fitting part is missing, you can e-mail this service card directly to the address below. However, we can only send fitting parts in this way. If you have any other cause for complaint concerning your item of furniture, please contact your furniture store directly.

CZ Naše přímé služby pro kování
Chybí-li vám nějaký díl z kování, můžete tuto servisní kartu odeslat e-mailem přímo na níže uvedenou adresu. Touto cestou však můžeme zoslat jen díly kování. Pokud byste reklamovali jiný díl nábytku, obraťte se přímo na svého prodejce nábytku.

F Bien étudier la notice de montage
S'il vous manque une ferrure, veuillez envoyer directement la présente carte service à l'adresse e-mail indiquée ci-dessous. Cependant, ceci nous permet uniquement d'envoyer des ferrures. Pour tout autre type de réclamation concernant votre meuble, veuillez contacter directement votre magasin d'ameublement.

I Il nostro servizio diretto per l'ordine della ferramenta
Qualora Vi dovesse mancare un pezzo di fissaggio, allora Vi preghiamo di inviare questa carta di servizio immediatamente all'indirizzo sottostante. Possiamo inviare i pezzi di fissaggio solamente per mezzo di questo procedimento. Qualora doveste avere qualche altra reclamazione in merito al mobile, allora Vi preghiamo di rivolgerVi direttamente al Vostro Negozio di mobili.

BG Нашата директна услуга за обкове
Ако липсват части от комплекта, попълнете настоящата сервисна карта и ни я изпратете на e-mail адреса, посочен по-долу. По този начин можем да доставяме само липсващи елементи от обкова. Ако установите други дефекти по мебелната Ви съветваме да се обърнете към мебелната къща/магазин, от който сте закупили стоката.

NL Onze directservice voor losse onderdelen
Wanneer er een onderdeel ontbreekt, kunt u deze servicekaart direct aan onderstaand e-mailadres sturen. Wij kunnen langs deze weg echter alleen beslagdelen versturen. Mocht u een ander probleem aan uw meubel hebben, verzoeken wij u contact op te nemen met uw meubeldealer.

PL Nasz bezpośredni serwis części montażowych
Jeżeli brakuje części koniecznych do montażu, prosimy o przesłanie nam niniejszej karty serwisowej na niżej podany adres e-mailowy. W ten sposób możemy przelać Państwu tylko brakujące części. W przypadku innych reklamacji dotyczących mebla, prosimy zgłosić się do salonu meblowego, w którym został dokonany zakup.

HR Servis za okove
U slučaju da nedostaje neki od dijelova molimo vas da na dolje navedenu mail adresu pošaljete ovaj servisni obrazac. Na ovaj način mogu se dostaviti samo okovi. U slučaju da imate dodatne prigovore vezane uz komad namještaja molimo vas da se obratite izravno trgovini namještaja gdje je isti kupljen.

HU Direktszolgáltatunk vasalátok esetén
Ha hiányzik egy vasalatt, ezt a kártyát közvetlenül elküldheti az alább található címre. Azonban csak vasalátokat tudunk így küldeni. Amennyiben másfajta reklamáció áll fenn bútoráruját illetően, forduljon közvetlenül a bútoráruhoz.

SK Naš priamy servis pre časti kovania
Ak by Vám chýbala nejaká časť kovania, môžete poslať túto servisnú kartu poslať e-mailom na nižšie uvedenu adresu. Diely kovania vieme poslať iba týmto spôsobom. Ak by ste mali inú reklamáciu ohľadom Vašho nábytku, obraťte sa priamo na Vašu predajňu nábytku.

SLO Naše direktne uslužne storitve za okovje
Če vam manjka kakšno okovje, lahko to servisno kartico pošljete po e-pošti direktno na spodnji naslov. Po tej poti vam lahko pošljemo samo okovje. Če želite reklamirati kakšen drug del pohištva, se obrnite neposredno na vašo trgovino pohištva.

RO Service-ul nostru direct pentru feronerie
În cazul în care vă lipsește o piesă de feronerie puteți să trimiteți direct acest card de service prin e-mail la adresa de mai jos. Noi nu putem expedia piese de feronerie decât pe această cale. Dacă aveți o altă reclamație referitoare la piesa de mobilier, atunci vă rugăm să vă adresați direct la magazinul dvs. de mobilă.

RUS Наш прямой сервис для поставок фурнитуры
Если окажется, что Вам не хватает того или иного элемента фурнитуры, Вы можете отправить сервисную карту по факсу непосредственно на нижеприведенный адрес электронной почты. Однако, таким образом мы можем пересылать лишь фурнитуру. Если же у Вас возникнут иные претензии относительно приобретенной мебели, пожалуйста, обращайтесь непосредственно в организацию, осуществившую продажу.

S Vår direktservice för beslagdelar
Om du saknar en beslagdel kan du skicka detta servicekort direkt till e-postadressen som anges nedan. Tänk på att detta är den enda möjligheten att skicka beslagdelar till dig. Om du vill reklamera din möbel av en annan anledning måste du kontakta ditt möbelhus direkt.

ES Nuestro servicio directo para accesorios
Si le falta algún accesorio, puede enviar esta tarjeta de servicio directamente a la siguiente dirección. No obstante, por este método solo podemos enviar accesorios. Si tiene alguna otra objeción sobre su mueble, consulte directamente con su mueblería.

TR Donatılar için doğrudan servisimiz
Bir donatınız eksikse bu servis kartını doğrudan aşağıda bulunan adrese doğrudan mail yazabilirsiniz. Sadece bu yolla donatıları gönderebiliriz. Mobilyanızda başka şikayetleriniz varsa lütfen doğrudan mobilya satıcınıza danışın.

MHC1	x1	1911	320	15	2/2
MHC2	x1	1911	320	15	2/2
MHC3	x1	611	299	15	1/2
MHC4	x1	706	374	65	1/2
MHC9	x2	209	250	15	2/2
MHC10	x1	483	124	18	2/2
MHC11	x1	590	80	15	1/2
MHC12	x3	610	290	15	1/2
MHC14	x4	124	298	15	1/2
MHC15	x1	611	299	15	1/2
MHC16	x1	611	299	15	1/2
MHC17	x1	611	299	15	1/2

MHC18	x1	1911	80	22	2/2
MHC19	x1	1911	80	22	2/2
MHC24	x1	1189	386	4	2/2
MHC25	x1	313	80	32	1/2
MHC26	x1	313	80	32	1/2
MHC27	x1	655	80	32	1/2
MHC28	x1	368	623	3	2/2
MHC29	x1	1546	623	3	2/2
MHC30	x1	477	230	15	2/2
MHC31	x2	237	140	15	1/2
MHC32	x1	466	126	15	2/2
MHC33	x1	447	258	3	2/2
MHC34	x1	1159	477	18	2/2

SIENA 23M

Unser Direktservice für Beschlagteile

Sollte Ihnen ein Beschlagteil fehlen, können Sie diese Servicekarte direkt an die untenstehende Adresse mailen. Wir können allerdings nur Beschlagteile auf diesem Wege verschicken. Sollten Sie eine andere Beanspruchung an Ihren Möbelstück haben, so wenden Sie sich bitte direkt an Ihr Möbelhaus.

Our direct order service for fitting

If a fitting part is missing, you can e-mail this service card directly to the address below. However, we can only send fitting parts in this way. If you have any other cause for complaint concerning your item of furniture, please contact your furniture store directly.

Naše priamé služby pro kování

Chybil-li vám nějaký díl z kování, můžete tuto servisní kartu odeslat e-mailem přímo na níže uvedenou adresu. Touto cestou však můžeme zoslat jen díly kování. Pokud byste reklamovali jiný díl nábytku, obraťte se přímo na svého prodejce nábytku.

Bien étudier la notice de montage

Si l'un vous manque une ferrure, veuillez envoyer directement la présente carte service à l'adresse e-mail indiquée ci-dessous. Cependant, ceci nous permet uniquement d'envoyer des ferrures. Pour tout autre type de réclamation concernant votre meuble, veuillez contacter directement votre magasin d'ameublement.

Il nostro servizio diretto per l'ordine della ferramenta

Qualora Vi dovesse mancare un pezzo di fissaggio, allora Vi preghiamo di inviare questa carta di servizio immediatamente all'indirizzo sottostante. Possiamo inviare i pezzi di fissaggio solamente per mezzo di questo procedimento. Qualora dovesse avere qualche altra reclamazione in merito al mobile, allora Vi preghiamo di rivolgerVi direttamente al Vostro Negozio di mobili.

Нашата директна услуга за обкова

Ако липсват части от комплекта, попълнете настоящата сервисна карта и ни я изпратете на e-mail адреса, посочен по-долу. По този начин можем да доставяме само липсващи елементи от обкова. Ако установите други дефекти по мебелите, Ви съветваме да се обрънете към мебелната къща/магазин, от който сте закупили стоката.

Onze directservice voor losse onderdelen

Wanneer er een onderdeel ontbreekt, kunt u deze servicekaart direct aan onderstaand e-mailadres sturen. Wij kunnen langs deze weg echter alleen beslagdelen versturen. Mocht u een ander probleem aan uw meubel hebben, verzoek wij u contact op te nemen met uw meubeldealer.

Nasz bezpośredni serwis czeszczy montażowych

Jezeli brakuje części koniecznych do montażu, prosimy o przesłanie nam niniejszej karty serwisowej na niżej podany adres e-mailowy. W ten sposób możemy przesać Państwu tylko brakujące części. W przypadku innych reklamacji dotyczących mebla, prosimy zgłosić się do salonu meblowego, w którym został dokonany zakup.

Servis za okova

U slučaju da nedostaje neki od dijelova molimo vas da na dolje navedenu mail adresu pošaljete ovaj servisni obrazac. Na ovaj način mogu se dostaviti samo okovi. U slučaju da imate dodatne prigovore vezane uz komad namještaja molimo vas da se obratite izravno trgovini namještaja gdje je isti kupljen.

Direktzolgáltatunk vasalattok esetén

Ha hiányzik egy vasalat, ezi a kártyát közvetlenül elküldheti az alább található címre. Azonban csakis vasalattokat tudunk így küldeni. Amennyiben másfajta reklamáció áll fenn bütördarabját illetően, forduljon közvetlenül a butorháználhoz.

Náš priamy servis pre časti kovania

Ak by Vám chýbala nejaká časť kovania, môžete poslať túto servisnú kartu poslať e-mailom na nižšie uvedenú adresu. Díly kovania vieme poslať iba týmto spôsobom. Ak by ste mali inú reklamáciu ošhadom Vašho nábytku, obráťte sa priamo na Vašu predajňu nábytku.

Naše direktne uslužne storitve za okovje

Če vam manjka kakšno okovje, lahko to servisno kartico pošljete po e-pošti direktno na spodnji naslov. Po tej poti vam lahko pošljemo samo okovje. Če želite reklamirati kakšen drug del pohištva, se obrnite neposredno na vašo trgovino pohištva.

Service-ul nostru direct pentru feronerie

În cazul în care vă lipsește o piesă de feronerie puteți să trimiteți direct acest card de service prin e-mail la adresa de mai jos. Noi nu putem expedia piese de feronerie decât pe această cale. Dacă aveți o altă reclamație referitoare la piesa de mobilier, atunci vă rugăm să vă adresați direct la magazinul dvs. de mobilă.

Наш прямой сервис для поставок фурнитуры

Если окажется, что Вам не хватает того или иного элемента фурнитуры, Вы можете отправить сервисную карту по факсу непосредственно на нижеприведенный адрес электронной почты. Однако, таким образом мы можем переслать лишь фурнитуру. Если же у Вас возникнут иные претензии относительно приобретенной мебели, пожалуйста, обращайтесь непосредственно в организацию, осуществляющую продажу.

Vår direktservice för beslagsdelar















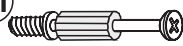





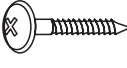

Om du saknar en beslagsdel kan du skicka detta servicekort direkt till e-postadressen som anges nedan. Tänk på att detta är den enda möjligheten att skicka beslagsdelar till dig. Om du vill reklamera din möbel av en annan anledning måste du kontakta ditt möbelhus direkt.

Nuestro servicio directo para accesorios

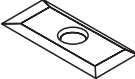
Si le falta algún accesorio, puede enviar esta tarjeta de servicio directamente a la siguiente dirección. No obstante, por este método solo podemos enviar accesorios. Si tiene alguna otra objeción sobre su mueble, consulte directamente con su mueblería.

Donatilar için doğrudan servisimiz

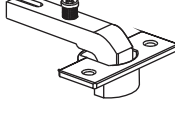
Bir donatınız eksikse bu servis kartını doğrudan aşağıda bulunan adrese doğrudan mail yazabilirsiniz. Sadece bu yolla donatılar gönderiliriz. Mobilyanızda başka şikayetleriniz varsa lütfen doğrudan mobilya satıcınıza danışın.

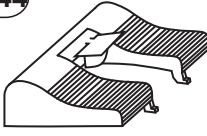
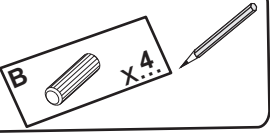
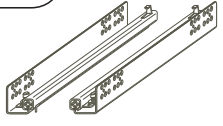
HCB1		1018	HCG5		1356
	8x28	X...			X...
HCM1		1336	HCS11		1073
		X...		3x16	X...
HCT1		1336	HCS3		1011
		X...		3,5x13	X...
HCJ23		1302	HCK13		49716
		X...			X...
HCW2		1290	HCU4		133907
		X...		L-160	X...
HCC6		00000	HCJ11		1267
	φ20	X...			X...
HCF36		1305	HCP6		1056
		X...		3x20	X...
HCA6		2549	HCE1		1008
	WPM 4x22	X...		ES 6,3x9,5	X...
HCG54		126680	HCF1		1415
		X...			X...
HCP2		1267	HCD14		23515
	3,5x13	X...		H4	X...
HCK1		1354	HCZ4		49365
	7x50	X...			X...
HCF14		1021		φ35 90°	X...
		X...			X...
HCK15		000000	HCF44		116795
		X...			X...
			HCR40		60497
				250	X...

SIENA 31M

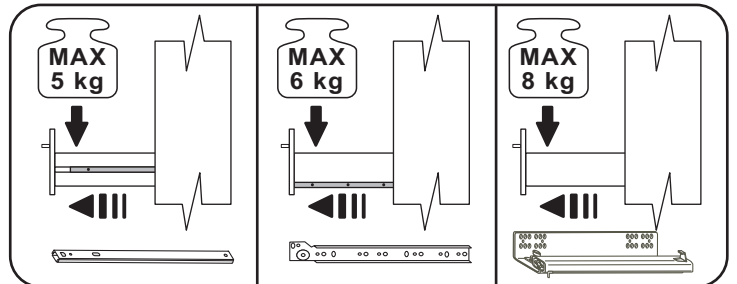
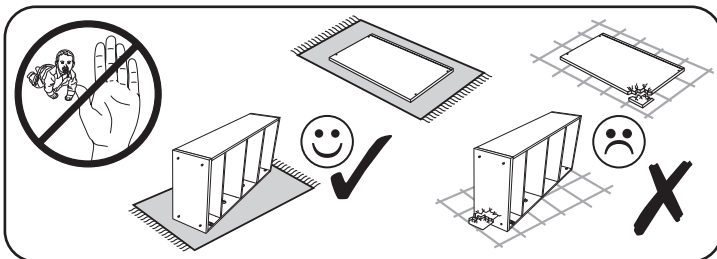
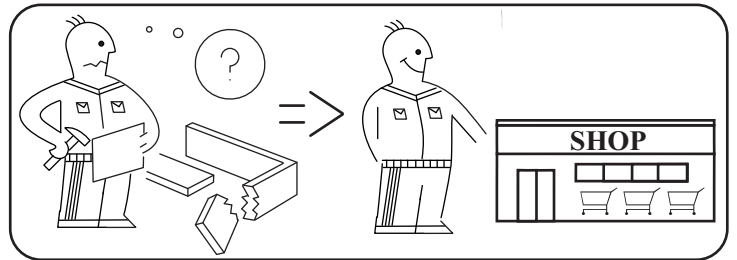
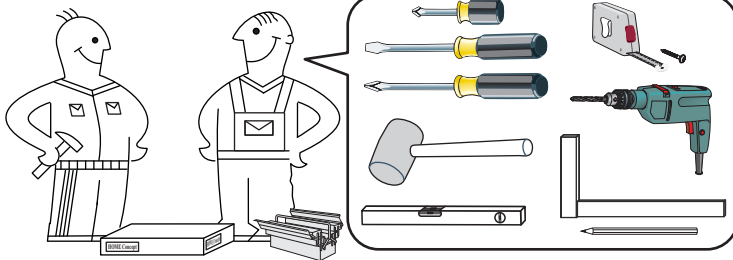
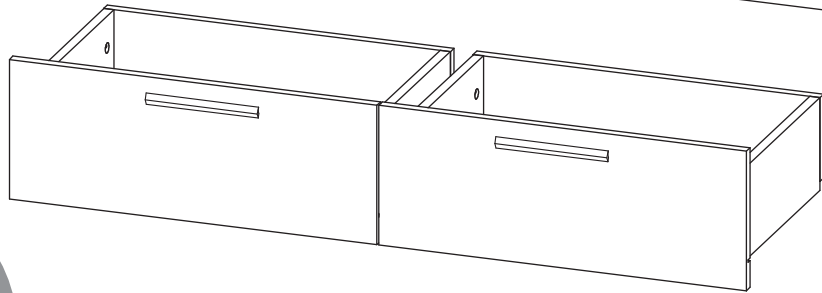
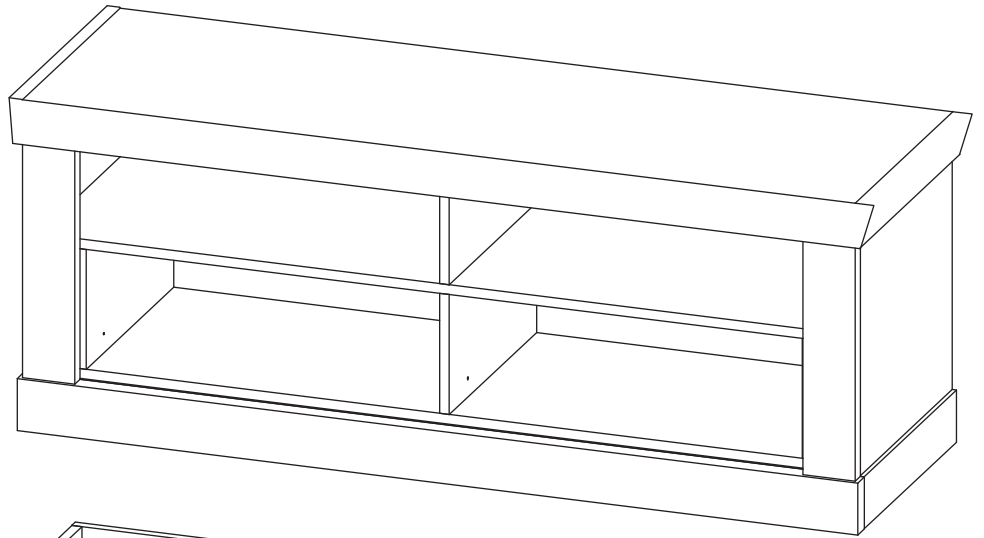
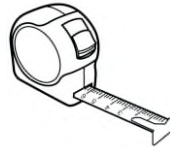
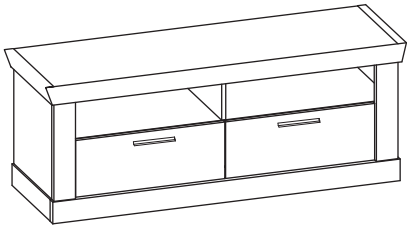

SIENA 31M

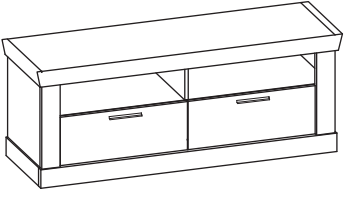

max.



MHC3 MHC4

max.



MHC8

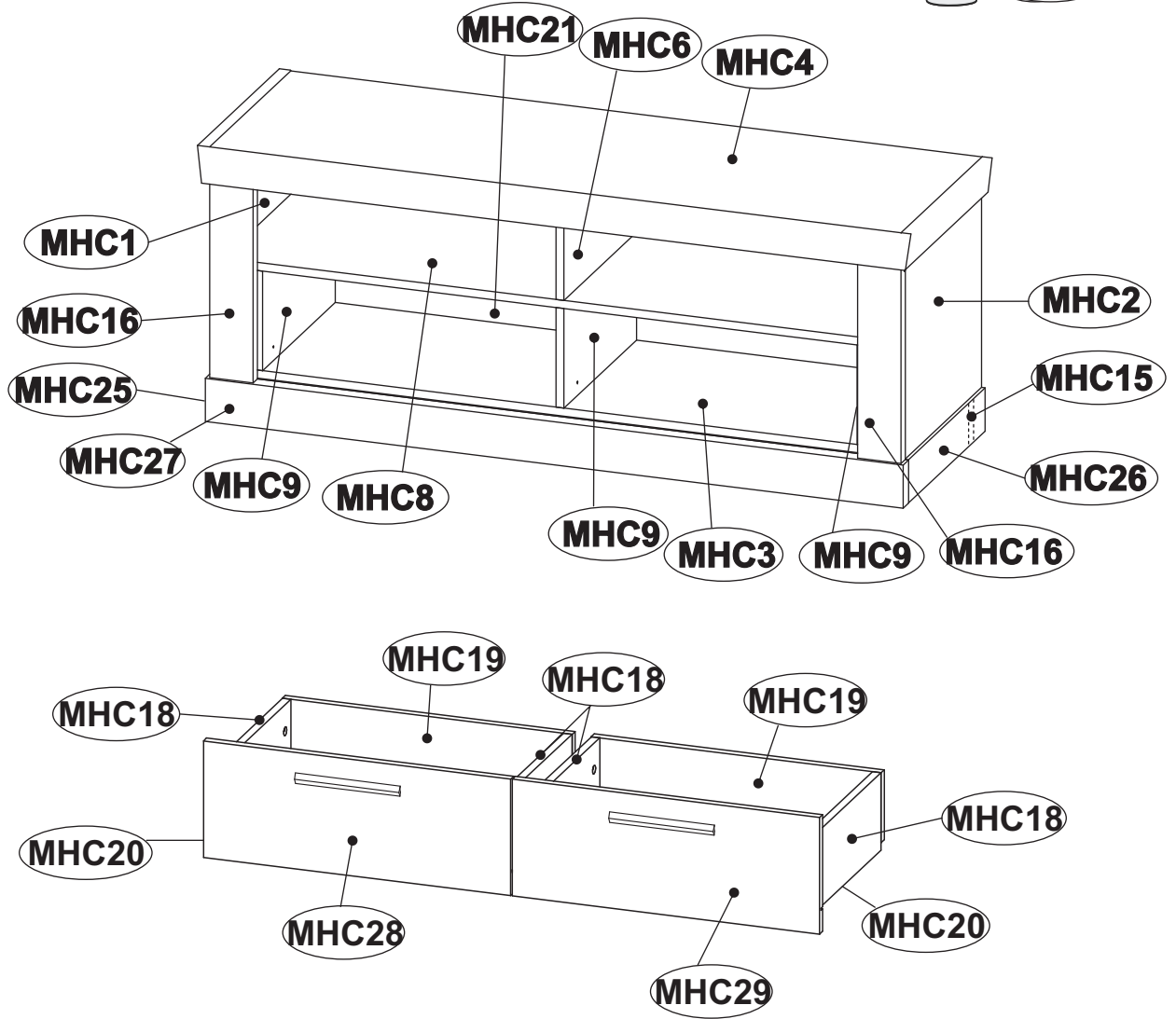

MHC1	x1	411	389	15	1/1
MHC2	x1	411	389	15	1/1
MHC3	x1	1244	368	15	1/1
MHC4	x1	1339	443	65	1/1
MHC6	x1	196	367	15	1/1
MHC8	x1	1244	368	15	1/1
MHC9	x3	185	368	18	1/1
MHC15	x1	1223	80	15	1/1
MHC16	x2	411	80	22	1/1
MHC18	x4	305	140	15	1/1
MHC19	x2	534	126	15	1/1

MHC20	x2	515	326	3	1/1
MHC21	x1	1256	416	3	1/1
MHC25	x1	382	80	32	1/1
MHC26	x1	382	80	32	1/1
MHC27	x1	1288	80	32	1/1
MHC28	x1	553	210	15	1/1
MHC29	x1	553	210	15	1/1

SIENA 31M

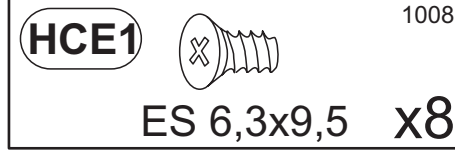
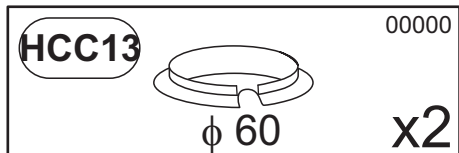
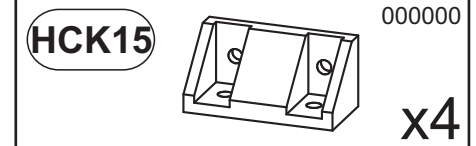
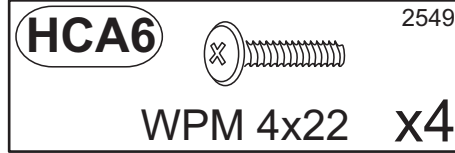
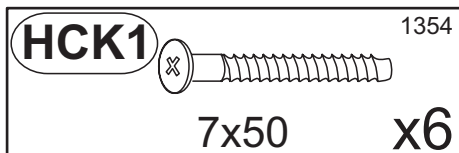
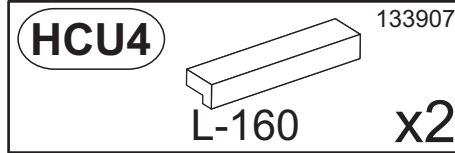
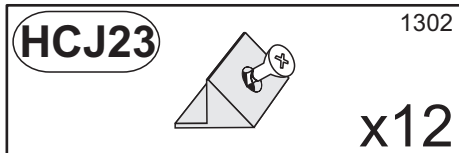
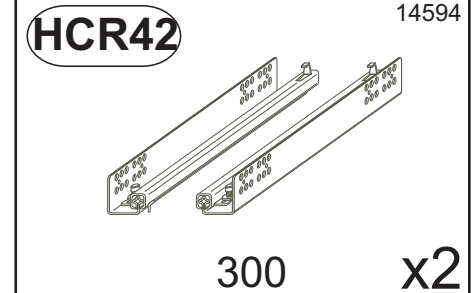
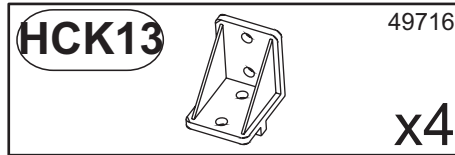
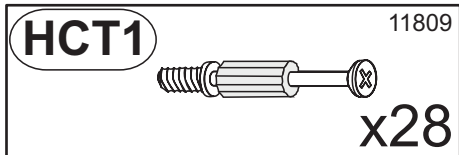
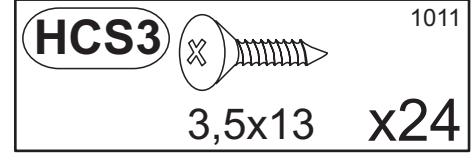
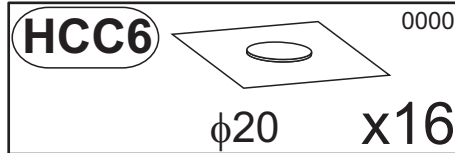
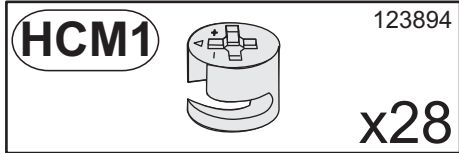
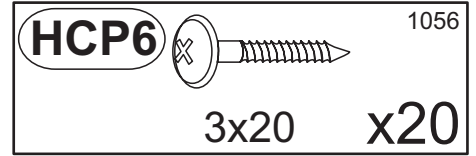
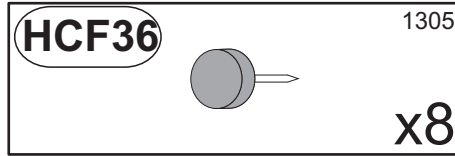
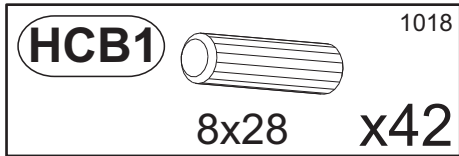

1



HCB1		1018
	8x28	x16
HCM1		123894
		x8
HCT1		11809
		x8

x4

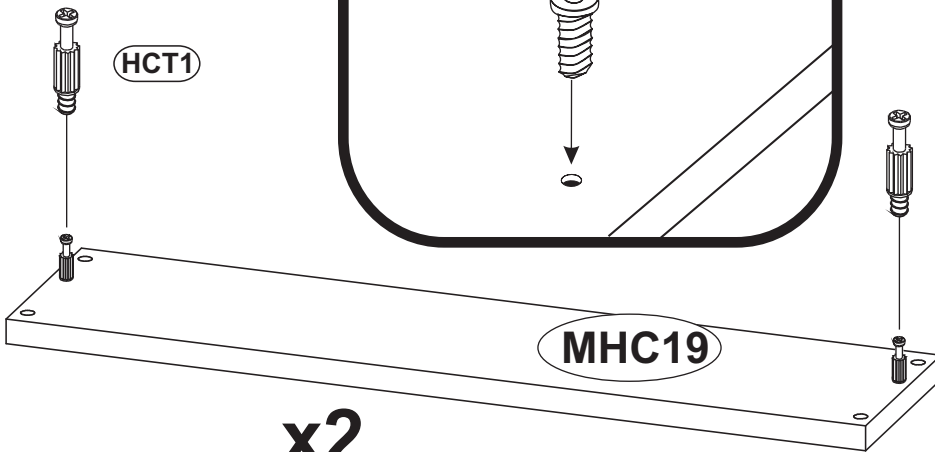
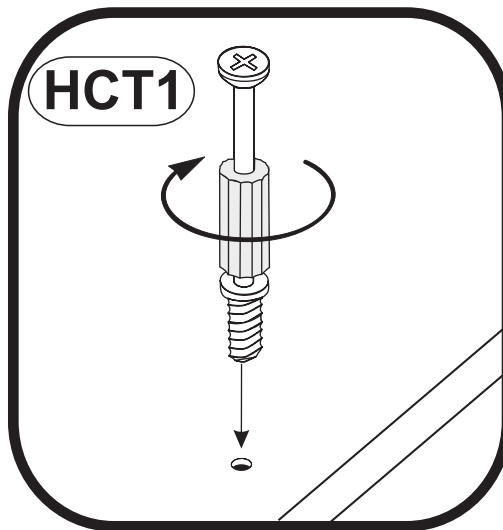
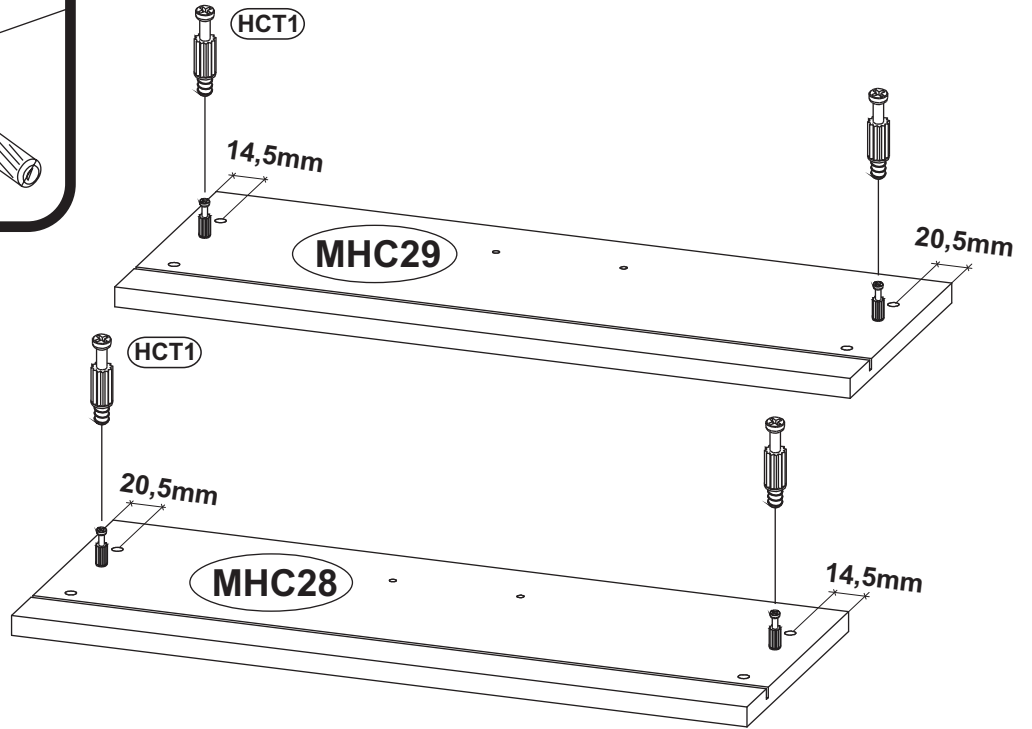
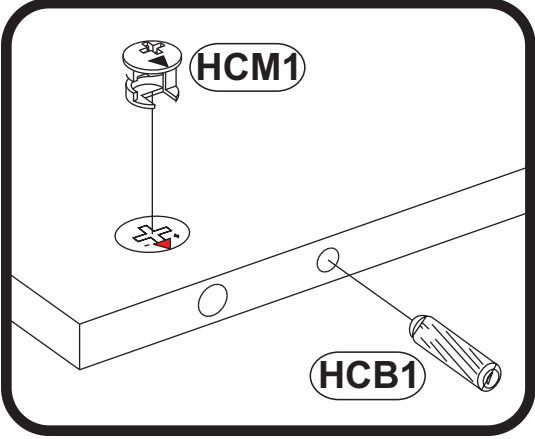

x2

2

HCJ23		1302	x4
HCP6		1056	x8
		3x20	



x2

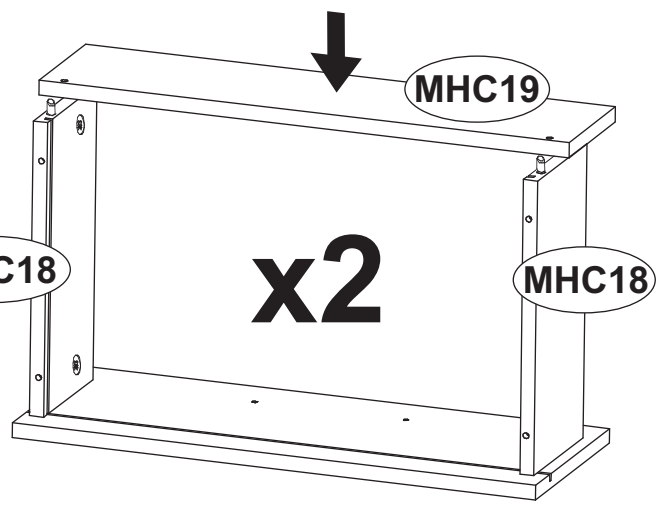

x2

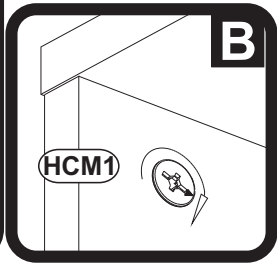
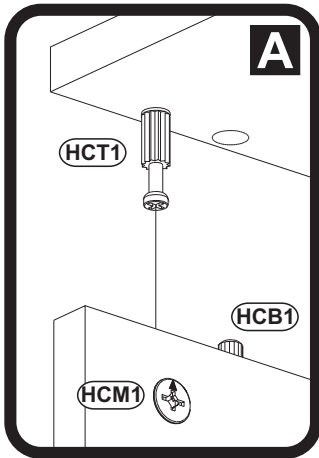
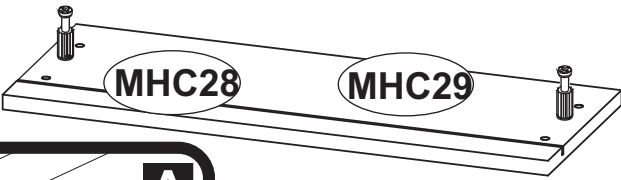

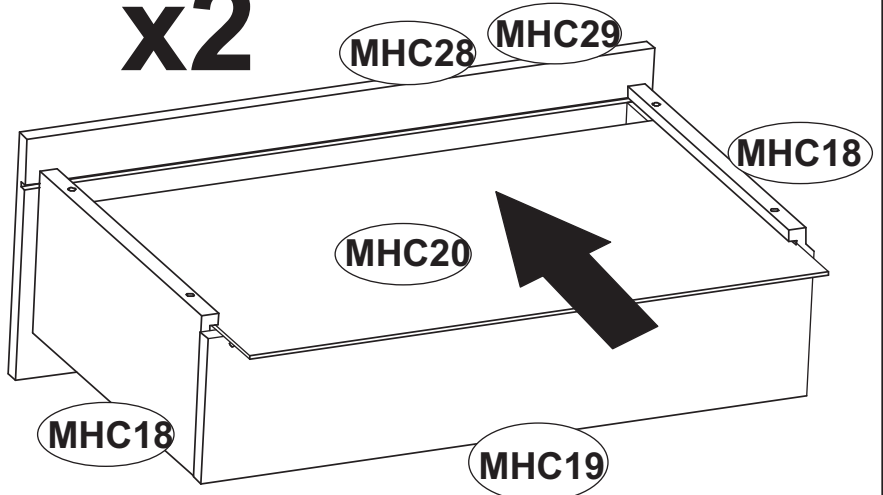

x2

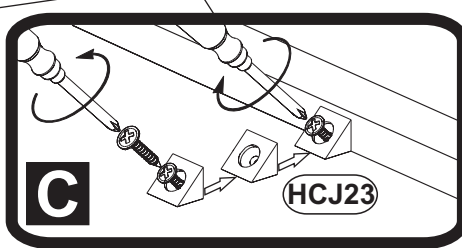
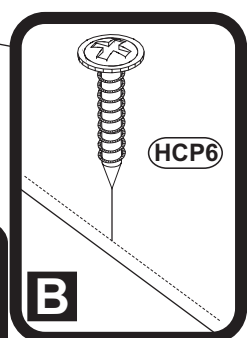
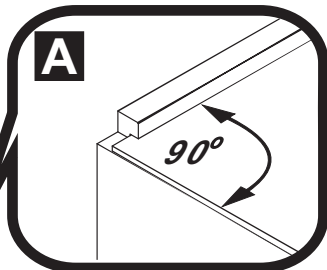
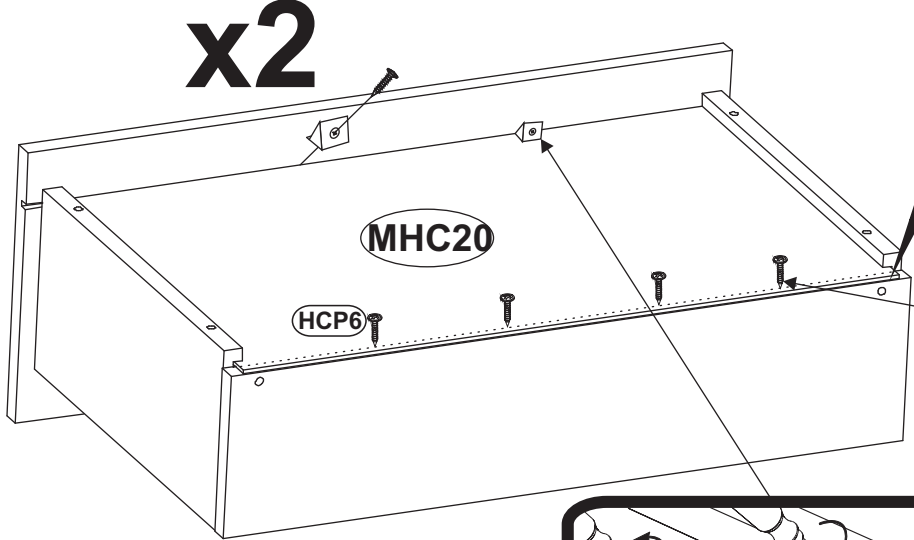

x2

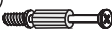

3

HCB1		1018
	8x28	x8
HCM1		123894
		x8
HCT1		11809
		x4

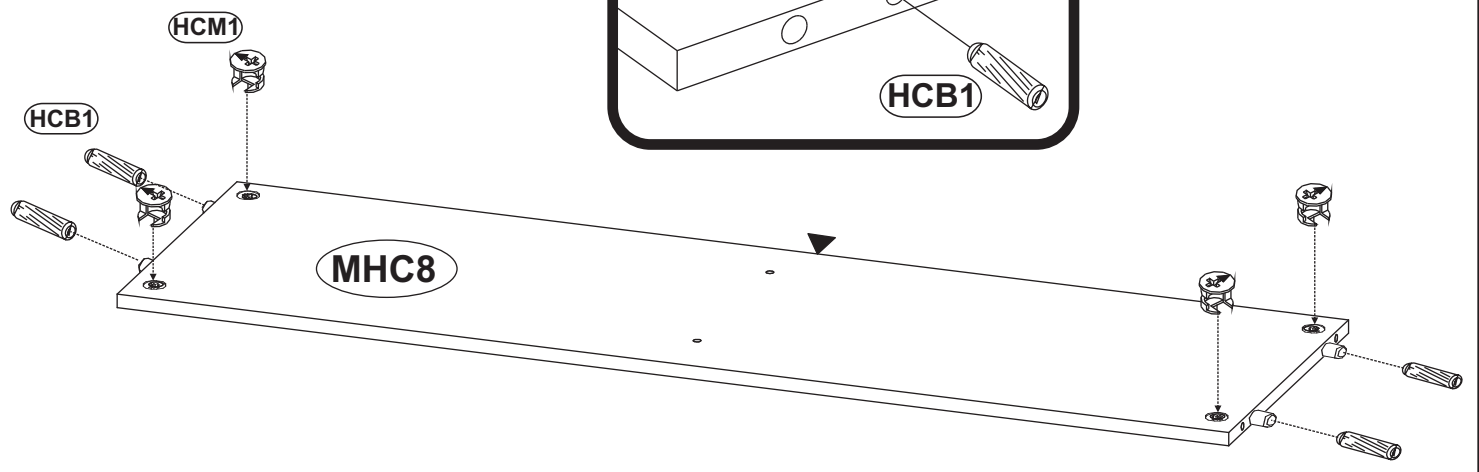
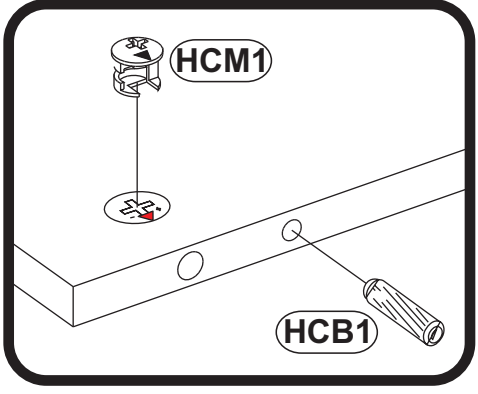
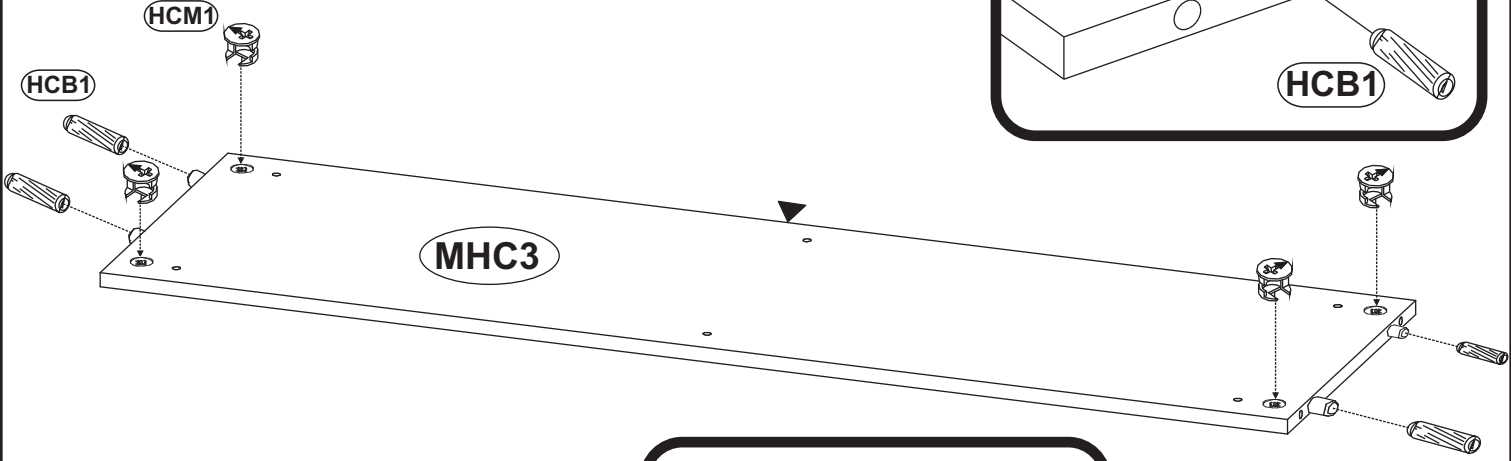
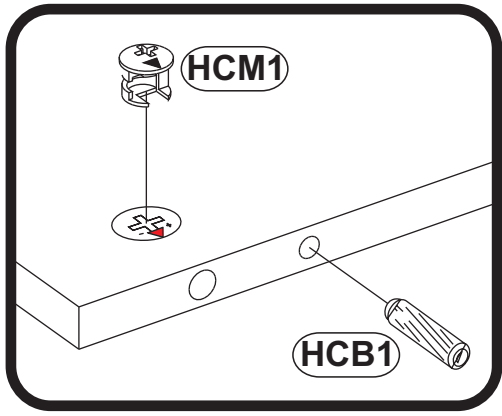
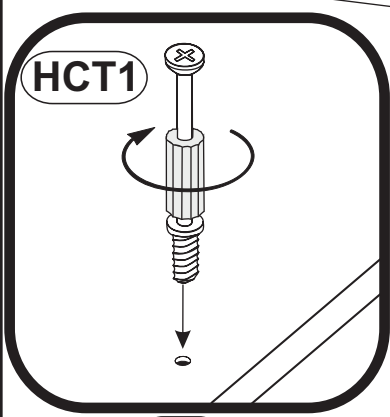
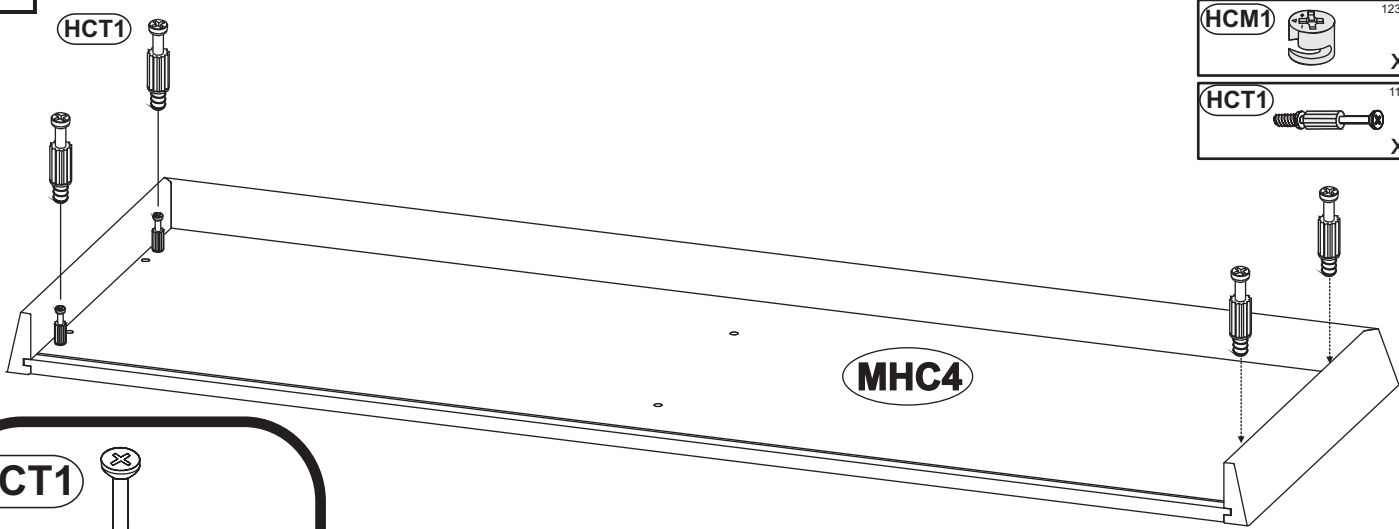

4

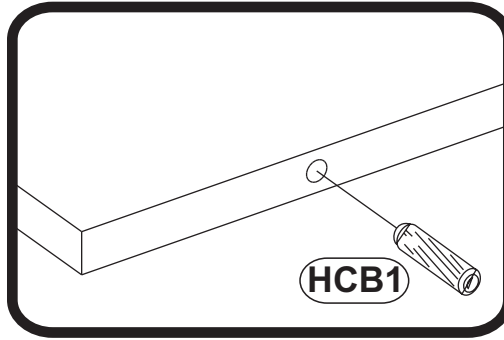
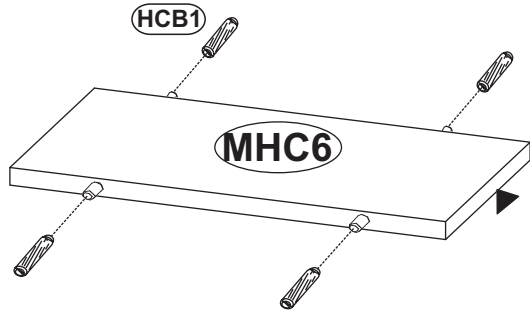

HCB1 1018
8x28 x10

HCR42 14594
300 x2

HCE1 1008
ES 6,3x9,5 x8

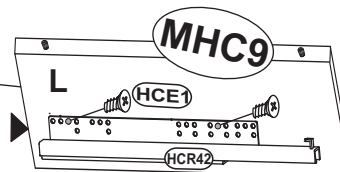
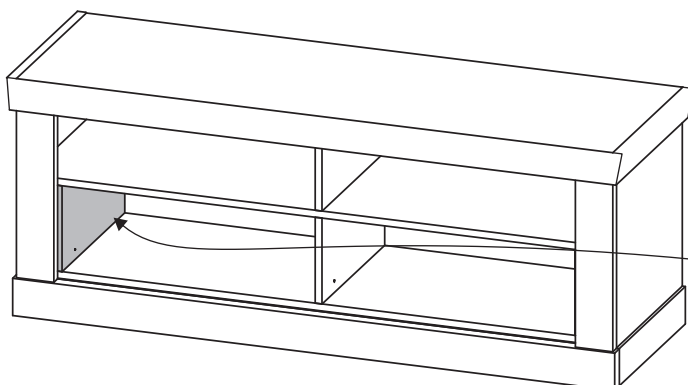
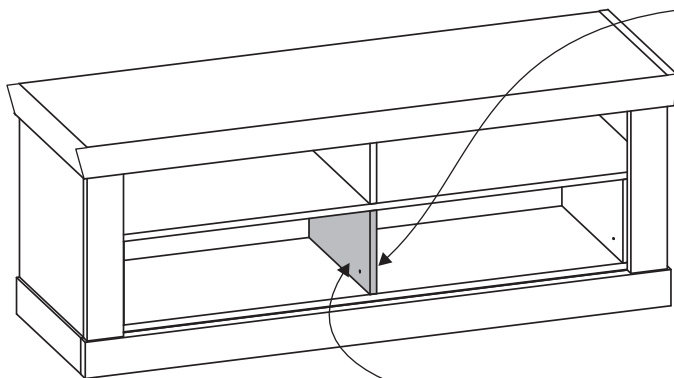
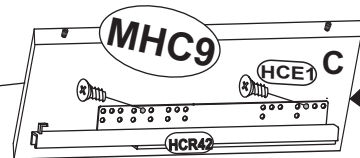
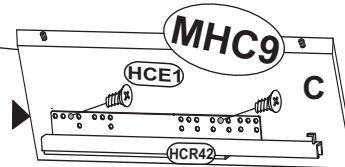
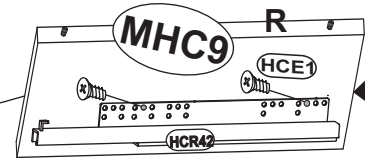
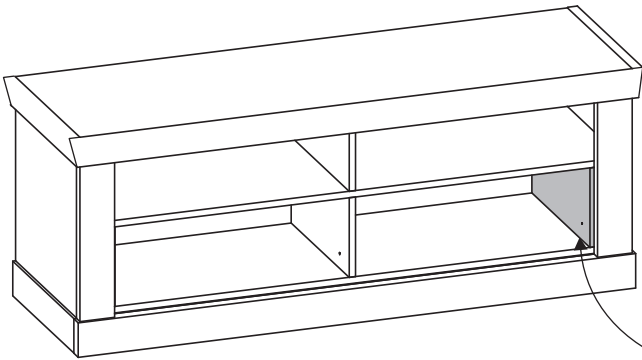
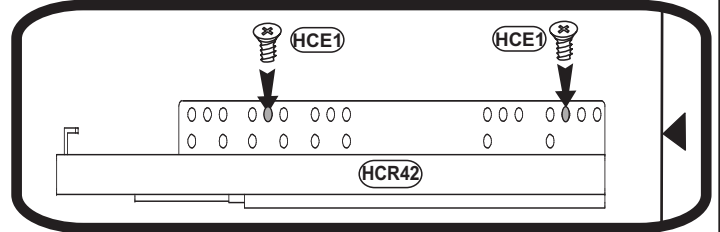
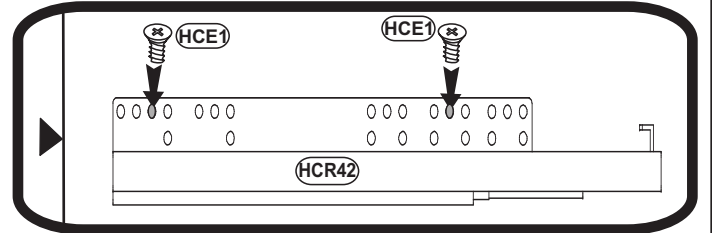
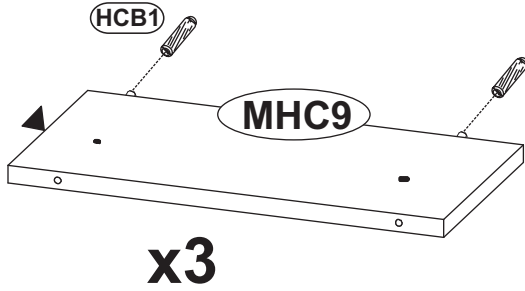

5

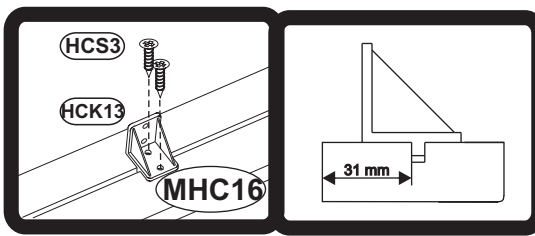

HCB1		1018
	8x28	x4
HCM1		123894
		x4
HCT1		11809
		x8
HCK13		49716
		x4
HCS3		1011
	3,5x13	x8

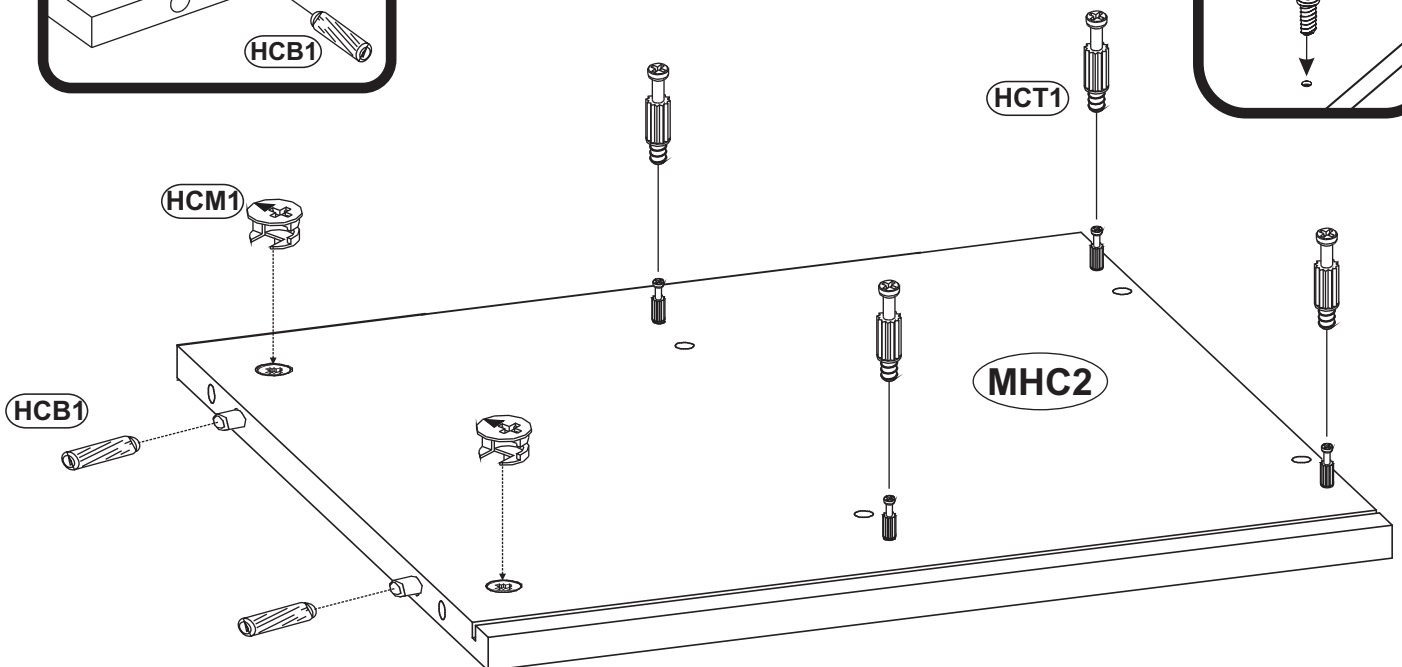
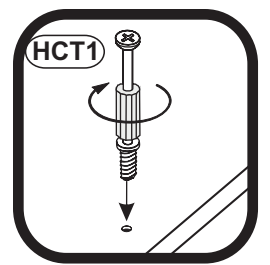
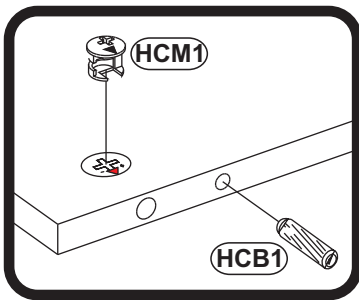
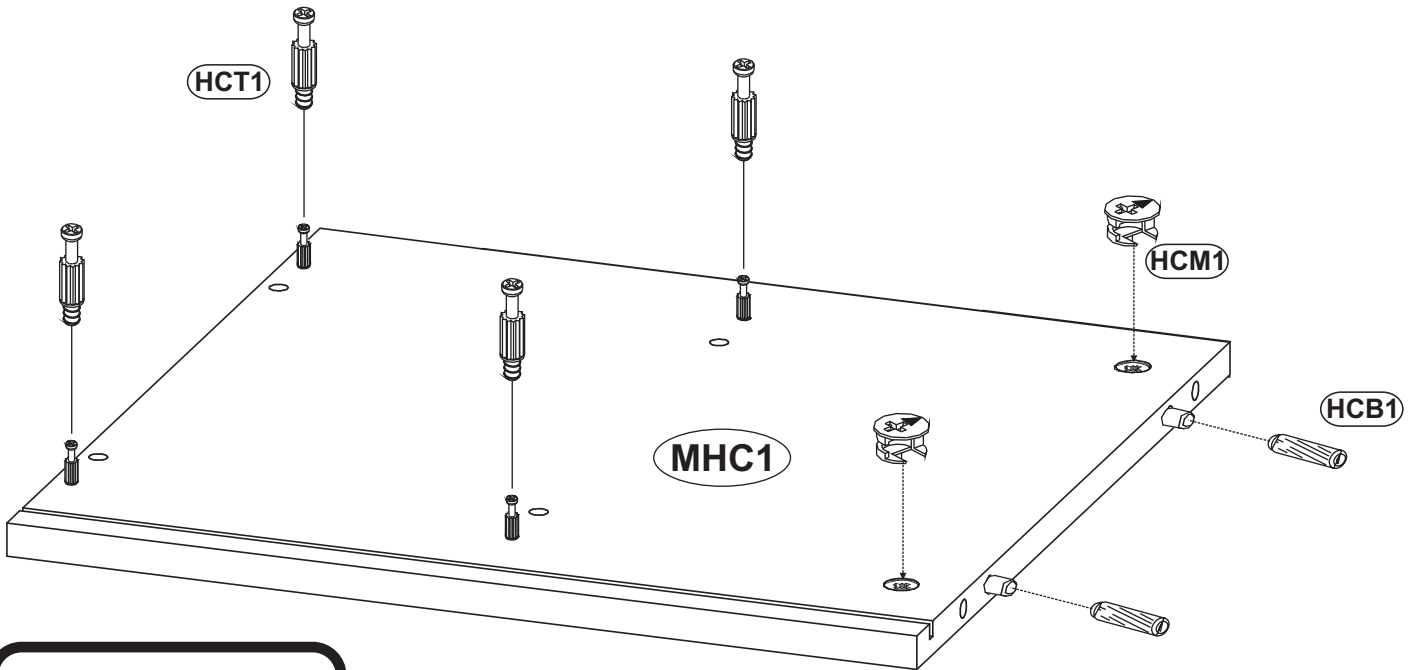
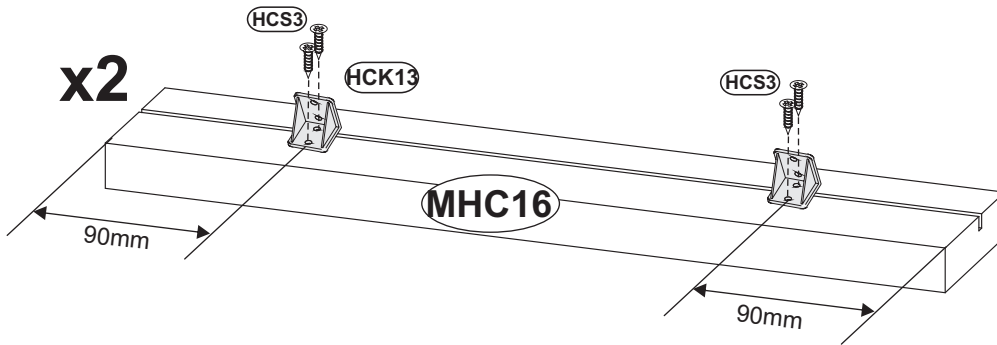

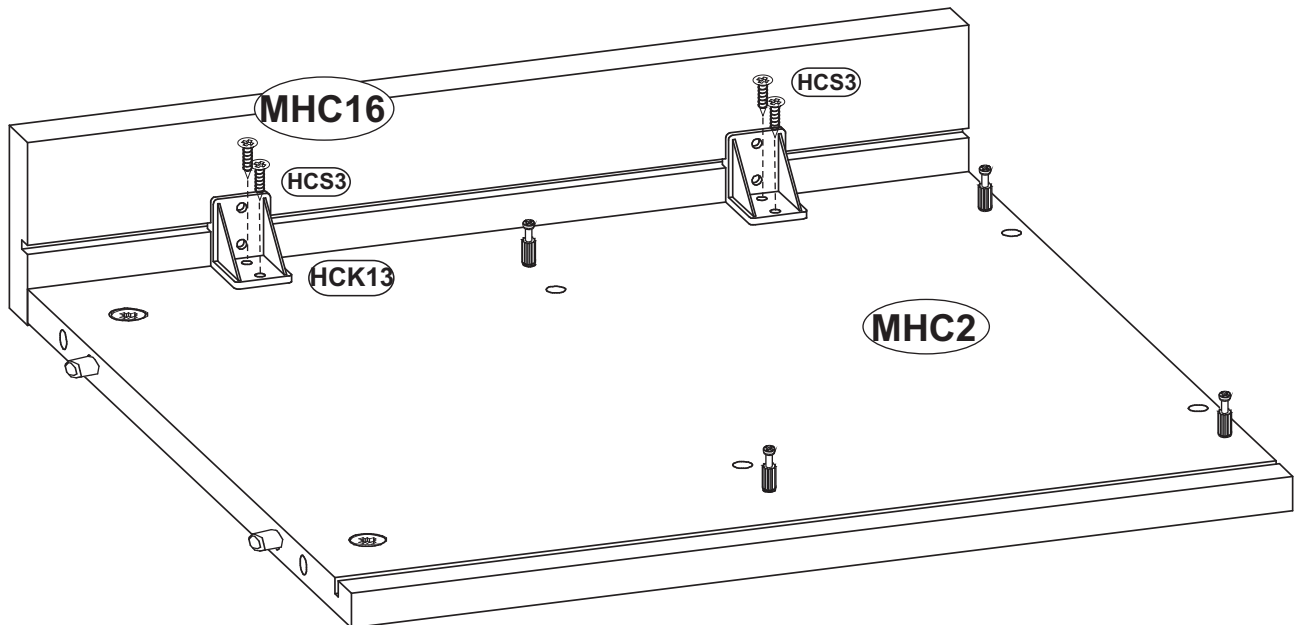
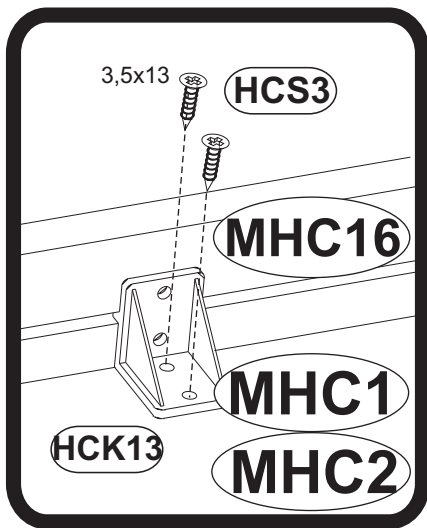
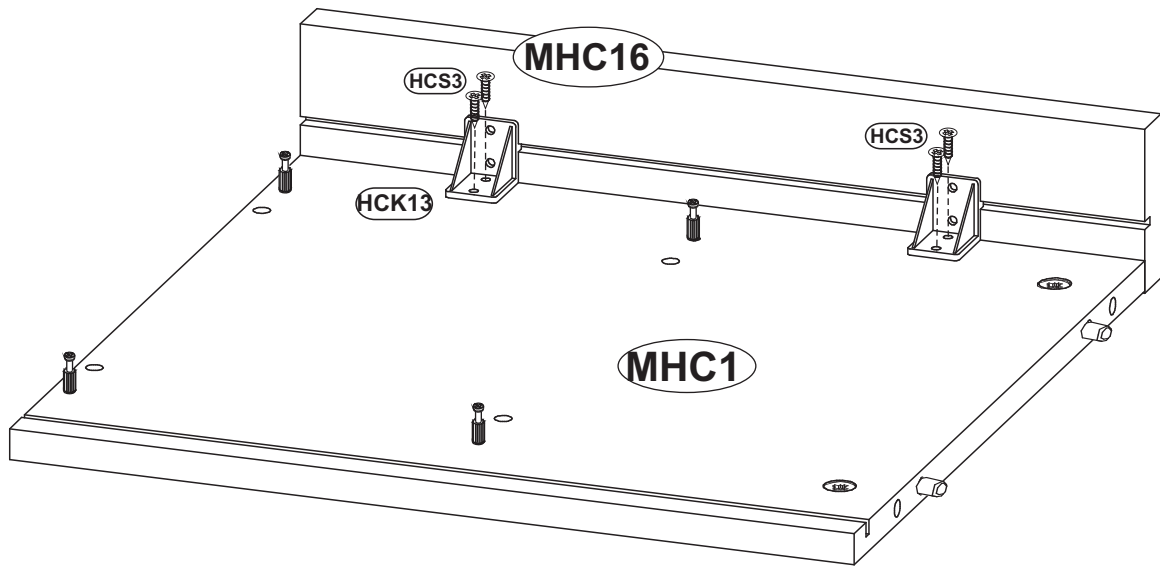

7

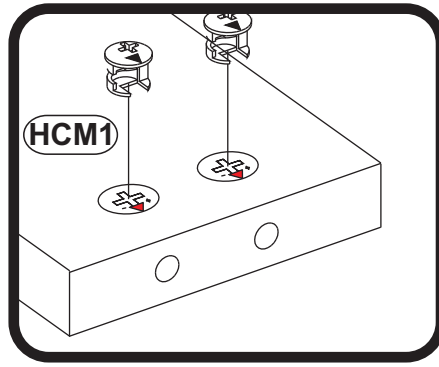
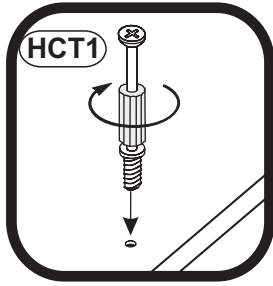

HCM1		123894	x8
HCT1		11809	x4
HCS3		1011	x4
HCK15		000000	x2
HCB1		1018	x4

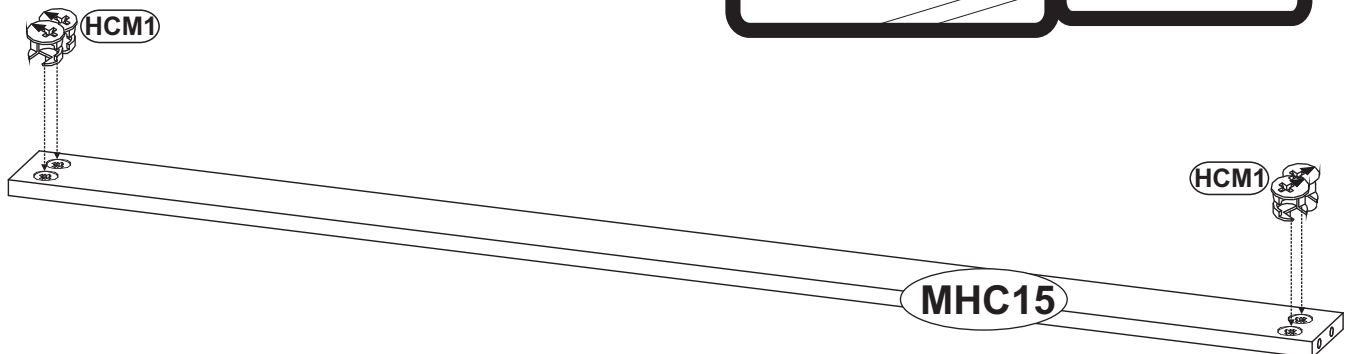
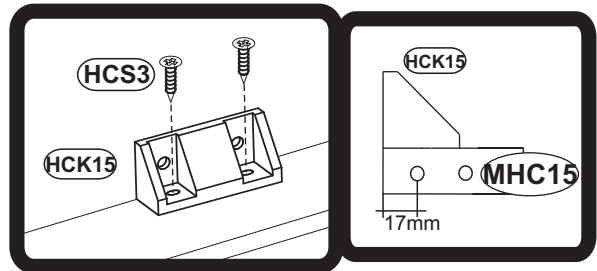
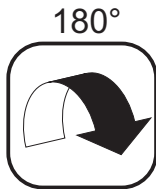
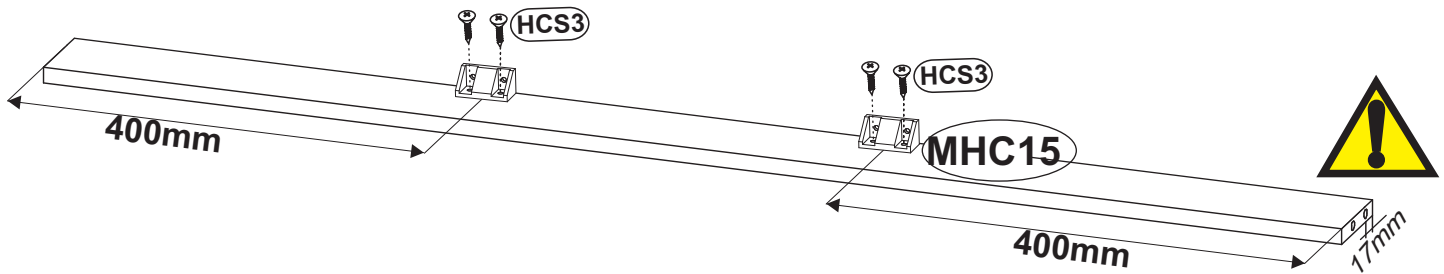
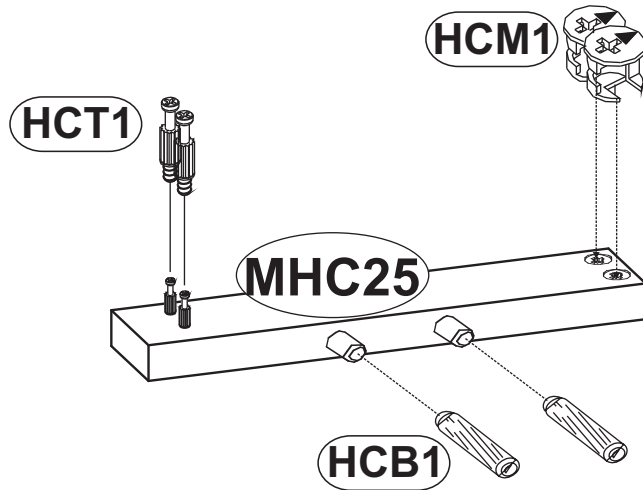
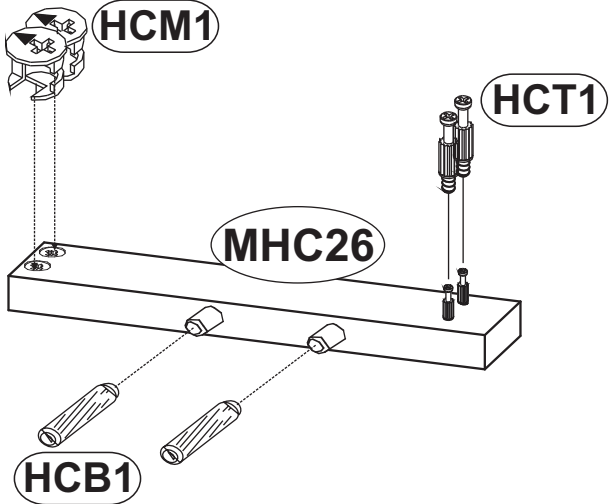

8

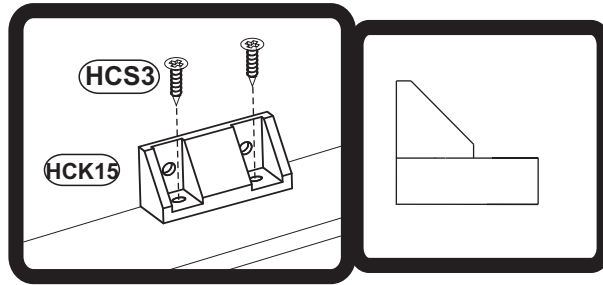
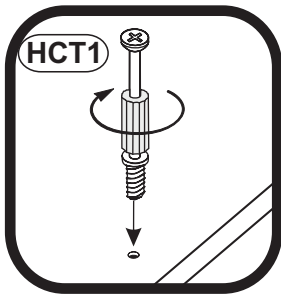

HCT1		11809	x4
HCS3		1011	x4
HCK19		000000	x2
HCF36		1305	x8

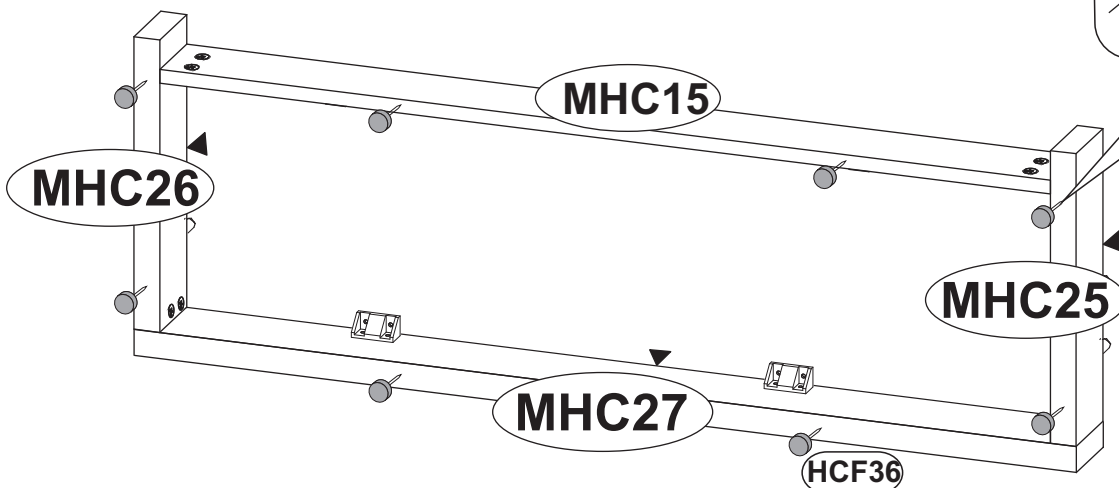
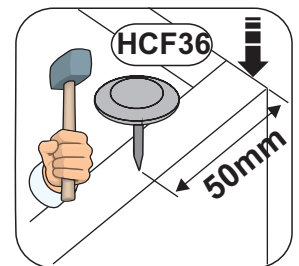
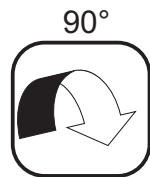
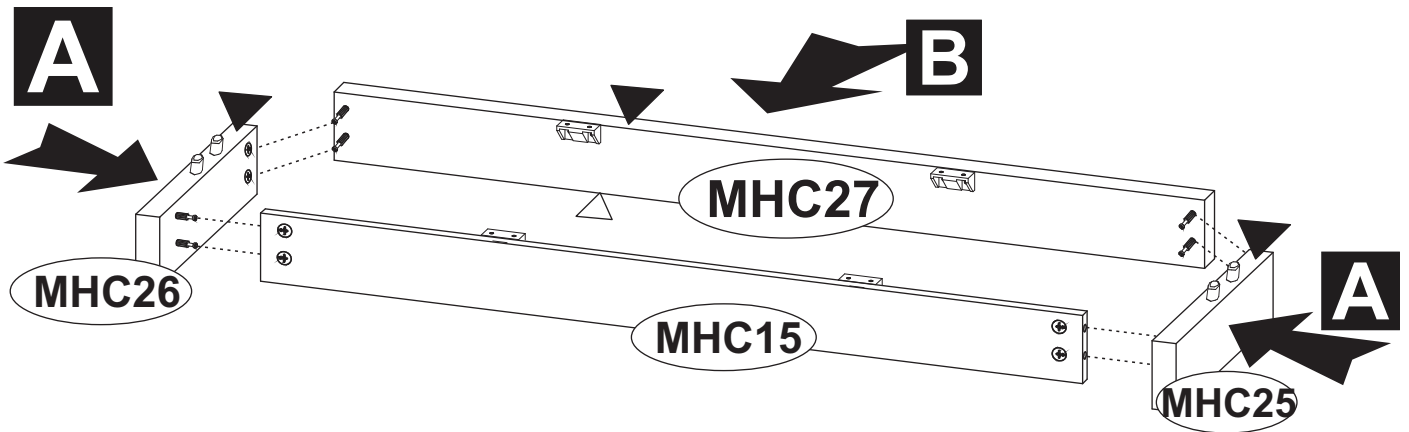
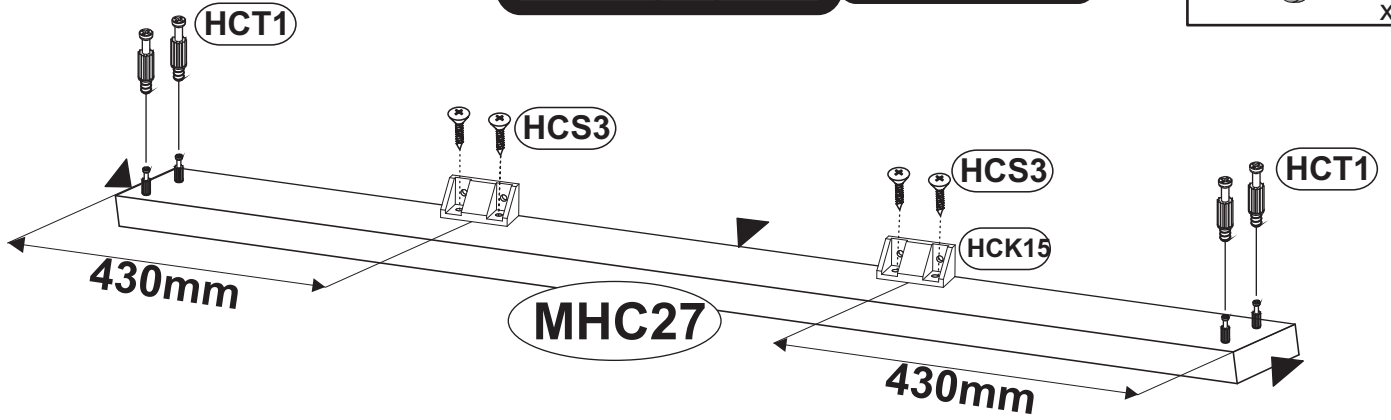

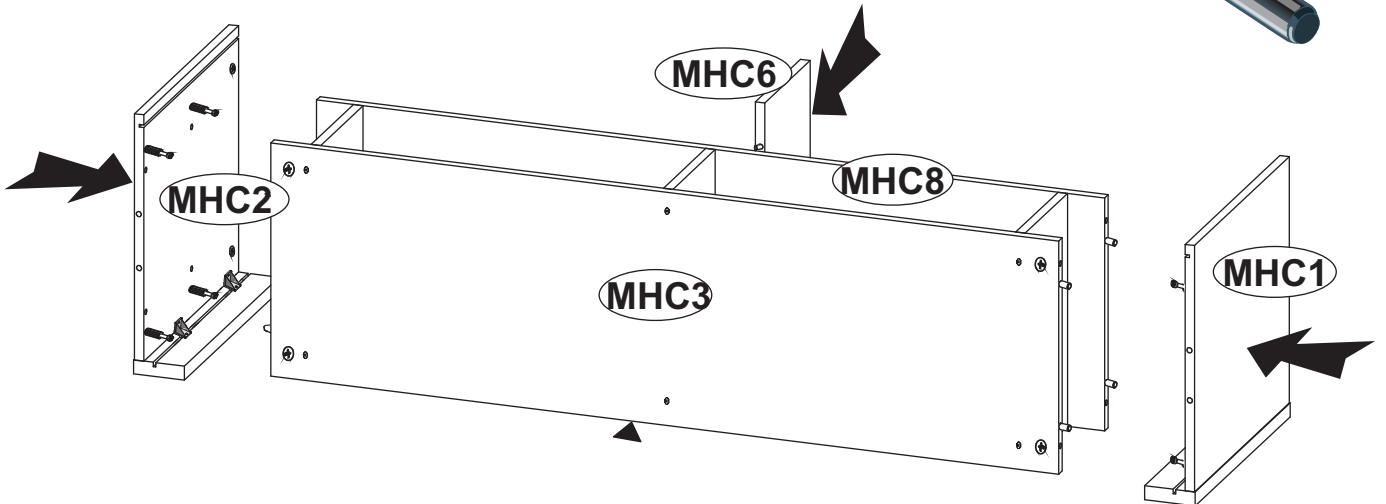
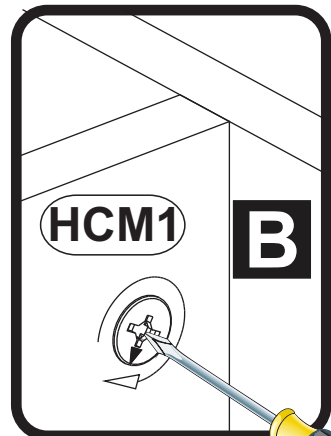
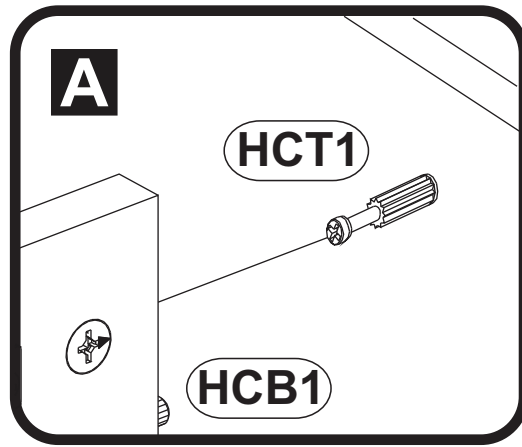
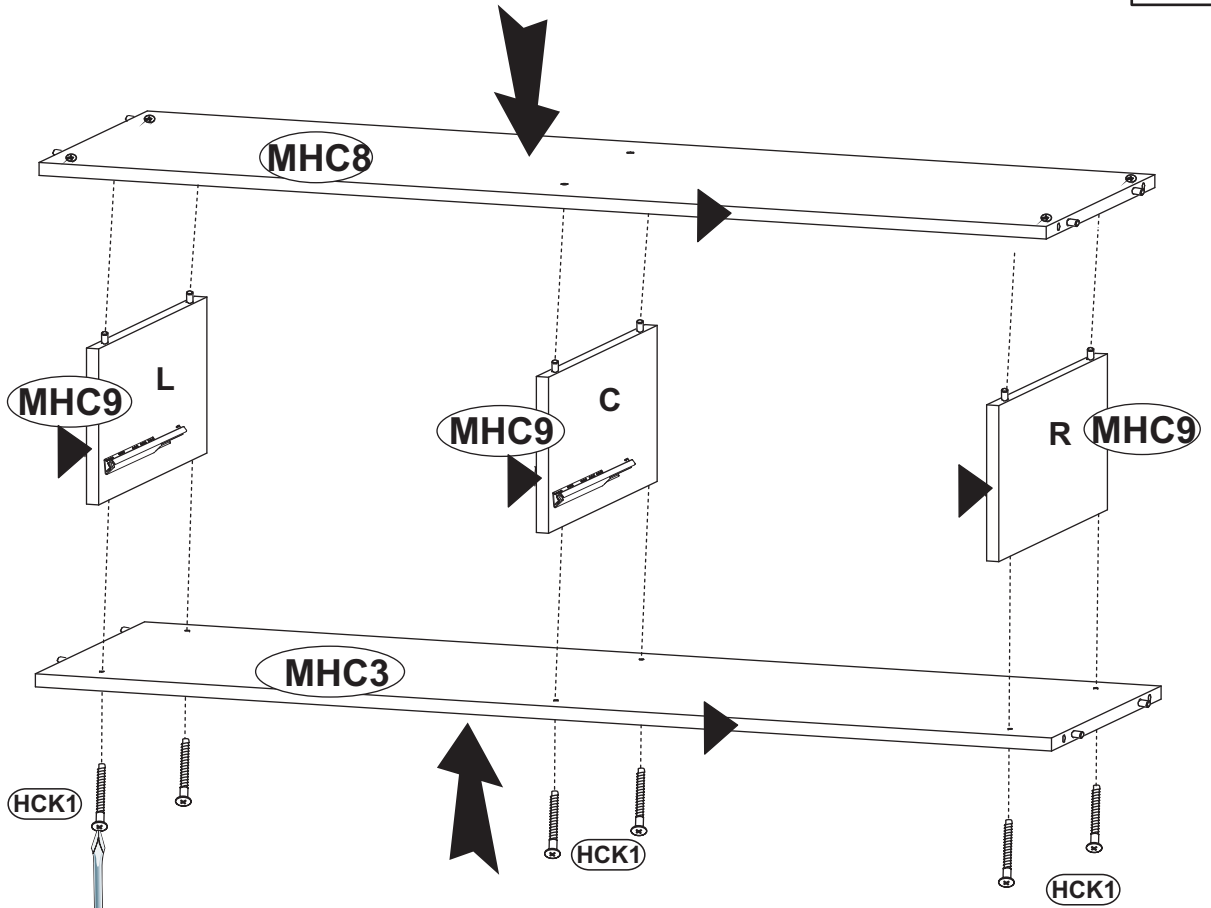

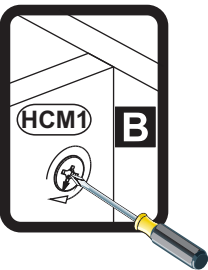
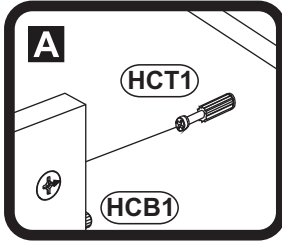
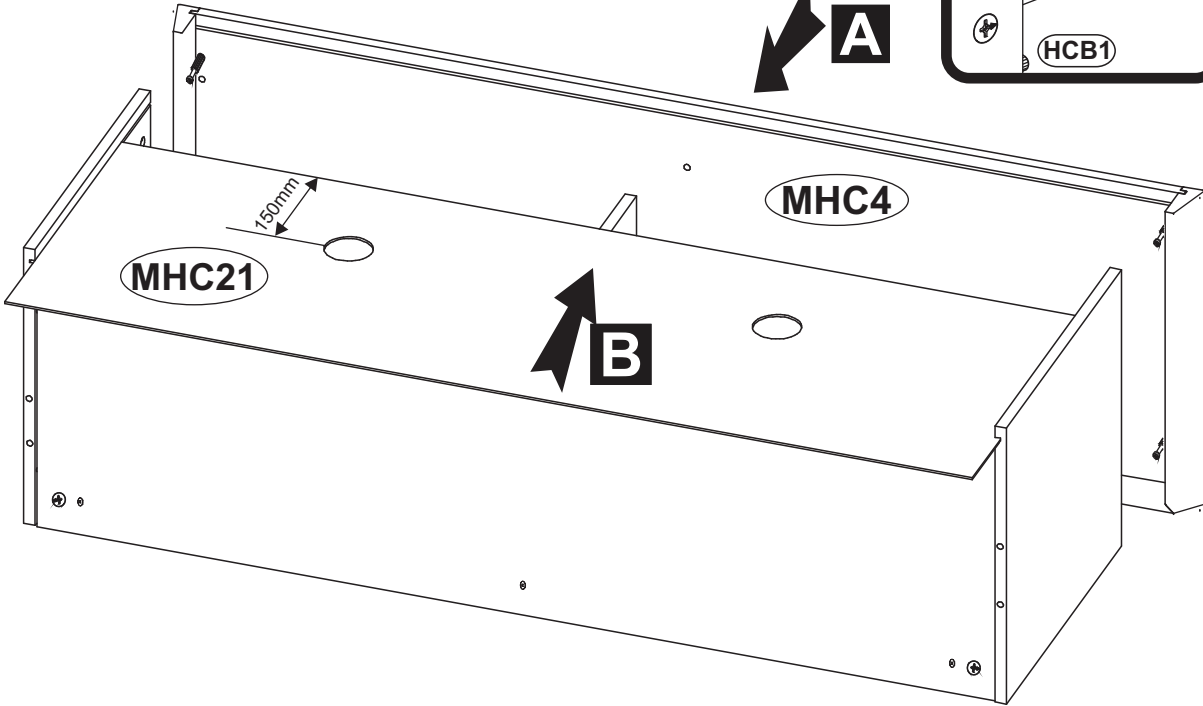

10



11

- HCS3**  1011
3,5x13 x8
- HCJ23**  1302
x8
- HCP6**  1056
3x20 x12

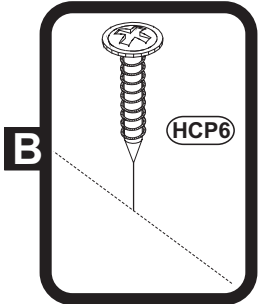
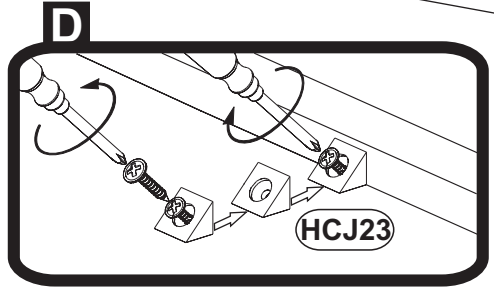
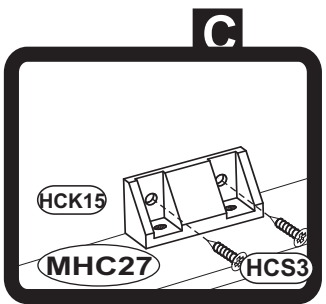
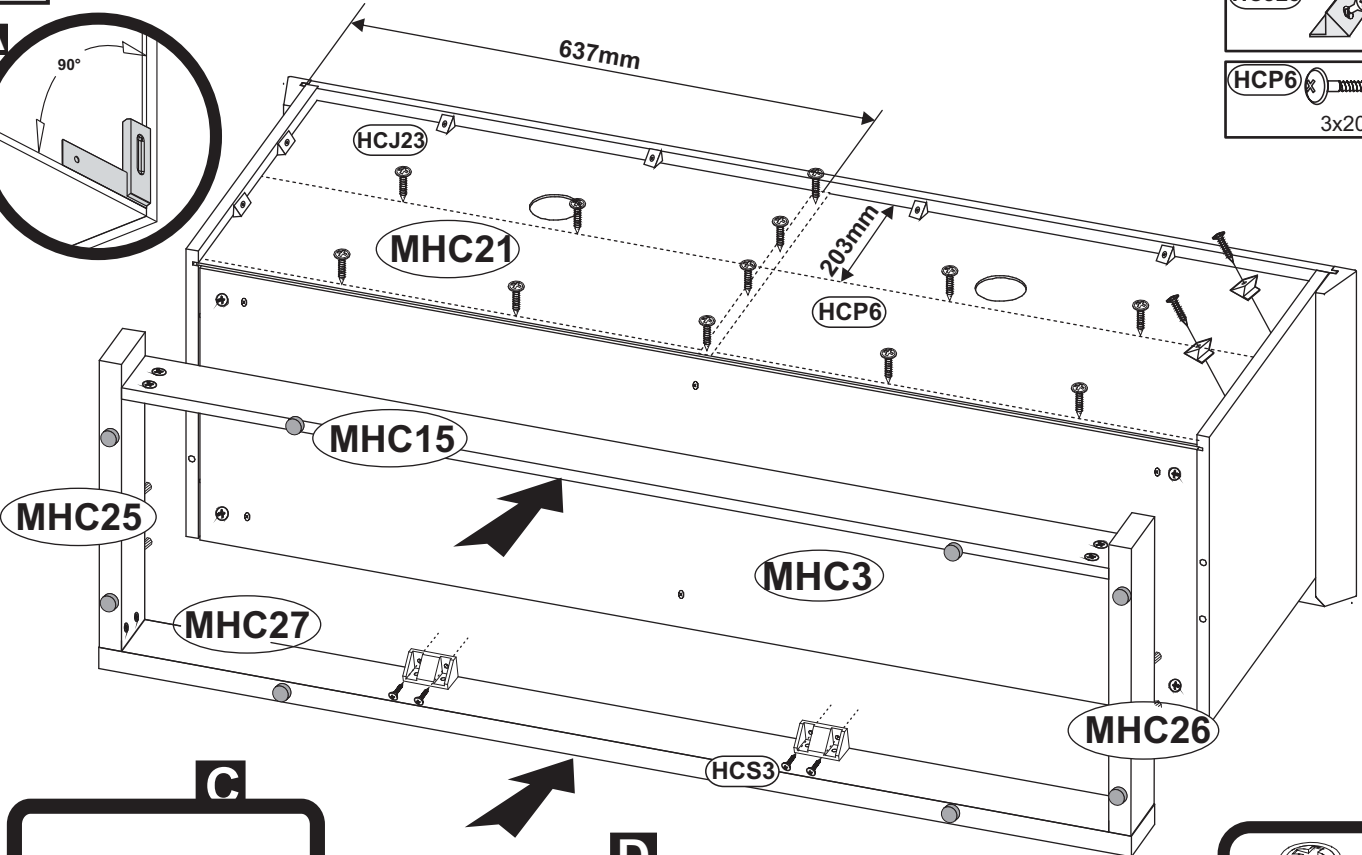
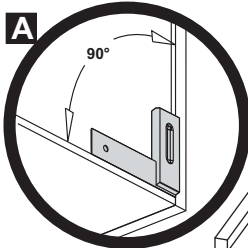

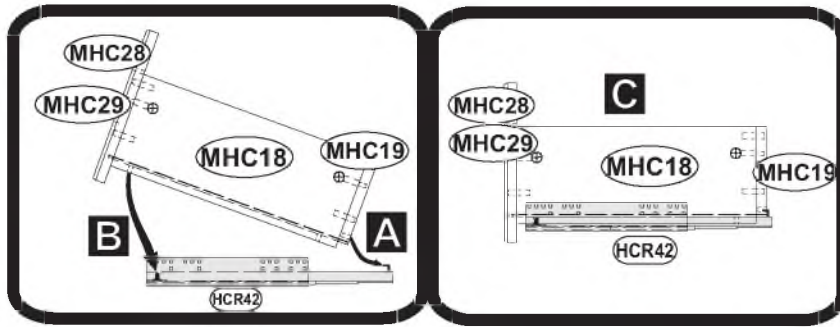

HCC6		0000
	φ20	x16
HCA6		2540
	WPM 4x22	x4
HCU4		133907
	L-160	x2
HCC13		00000
	φ 60	x2

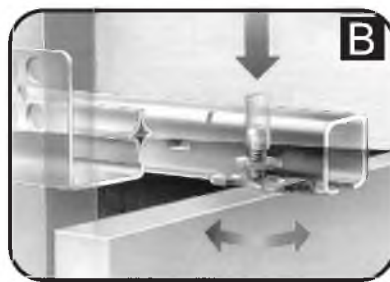
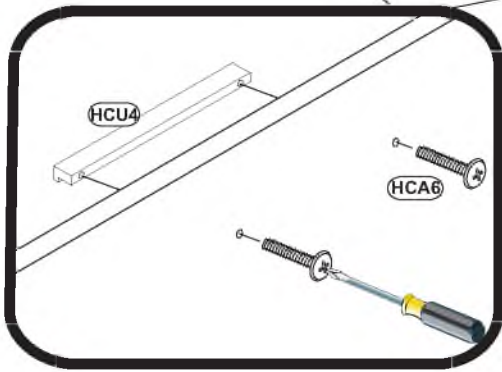
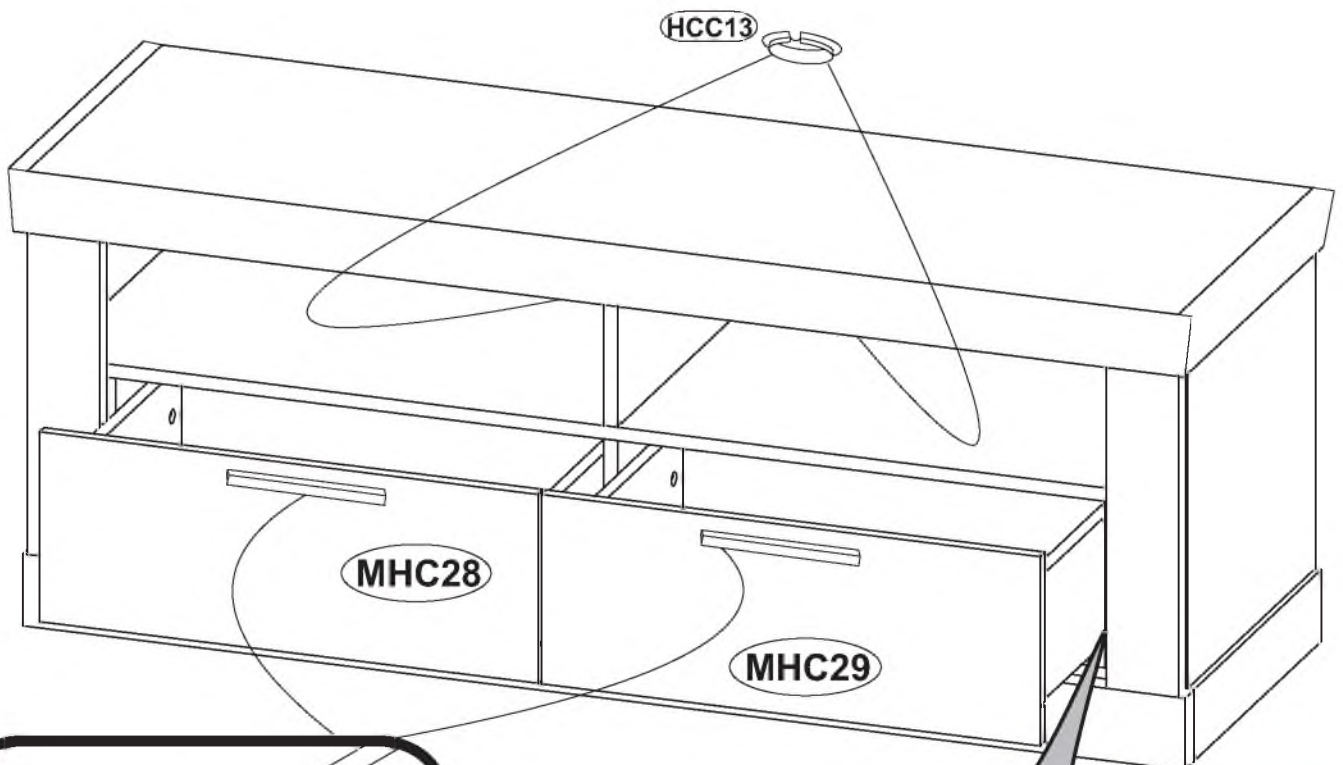

SIENA 31M

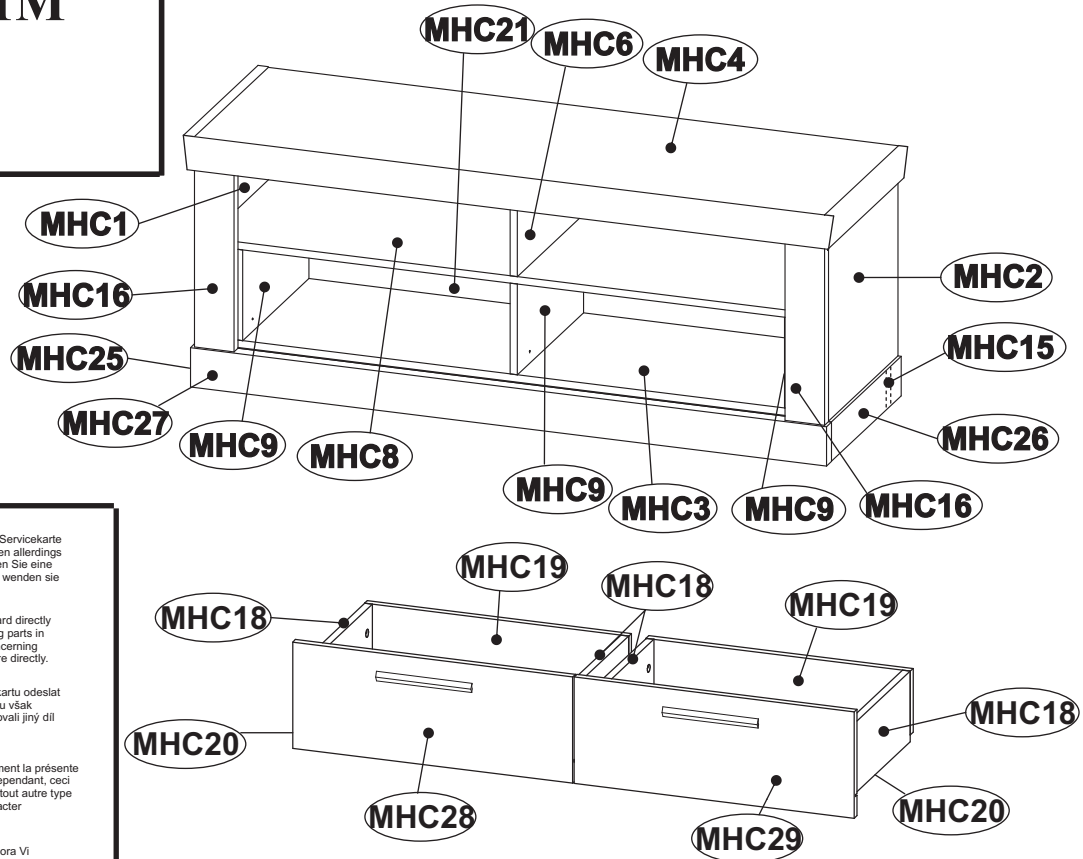

Unser Direktservice für Beschlagteile

D Sollte Ihnen ein Beschlagteil fehlen, können Sie diese Servicekarte direkt an die untenstehende Adresse mailen. Wir können allerdings nur Beschlagteile auf diesem Wege verschicken. Sollten Sie eine andere Beanstandung an Ihrem Möbelstück haben, so wenden Sie sich bitte direkt an Ihr Möbelhaus.

Our direct order service for fitting

GB If a fitting part is missing, you can e-mail this service card directly to the address below. However, we can only send fitting parts in this way. If you have any other cause for complaint concerning your item of furniture, please contact your furniture store directly.

Naše primé služby pro kování

CZ Chybí-li vám nějaký díl z kování, můžete tuto servisní kartu odeslat e-mailem přímo na níže uvedenou adresu. Touto cestou však můžeme rozesílat jen díly kování. Pokud byste reklamovali jiný díl nábytku, obraťte se přímo na svého prodejce nábytku.

Bien étudier la notice de montage

F Si l'un des éléments de montage est manquant, veuillez envoyer directement la présente carte service à l'adresse e-mail indiquée ci-dessous. Cependant, ceci nous permet uniquement d'envoyer des ferrures. Pour tout autre type de réclamation concernant votre meuble, veuillez contacter directement votre magasin d'ameublement.

Il nostro servizio diretto per l'ordine della ferramenta

I Qualora Vi dovesse mancare un pezzo di fissaggio, allora Vi preghiamo di inviare questa carta di servizio immediatamente all'indirizzo sottostante. Possiamo inviare i pezzi di fissaggio solamente per mezzo di questo procedimento. Qualora dovesse avere qualche altra reclamazione in merito al mobile, allora Vi preghiamo di rivolgerVi direttamente al Vostro Negozio di mobili.

Нашата директна услуга за обков

BG Ако липсват части от комплекта, попълнете настоящата сервисна карта и ни я изпратете на e-mail адреса, посочен по-долу. По този начин можем да доставяме само липсващи елементи от обкова. Ако установите други дефекти по мебелите, Ви съветваме да се обърнете към мебелната къща/магазин, от който сте закупили стоката.

Onze directservice voor losse onderdelen

NL Wanneer er een onderdeel ontbreekt, kunt u deze servicekaart direct aan onderstaand e-mailadres sturen. Wij kunnen langs deze weg echter alleen beslagdelen versturen. Mocht u een ander probleem aan uw meubel hebben, verzoeken wij u contact op te nemen met uw meubeldealer.

Nasz bezpośredni serwis części montażowych

PL Jeżeli brakuje części koniecznych do montażu, prosimy o przesłanie nam niniejszej karty serwisowej na niżej podany adres e-mailowy. W ten sposób możemy przesyłać Państwu tylko brakujące części. W przypadku innych reklamacji dotyczących mebla, prosimy zgłosić się do salonu meblowego, w którym został dokonany zakup.

Servis za okove

HR U slučaju da nedostaje neki od dijelova molimo vas da na dolje navedenu mail adresu pošaljete ovaj servisni obrazac. Na ovaj način mogu se dostaviti samo okovi. U slučaju da imate dodatne prigovore vezane uz komad namještaja molimo vas da se obratite izravno trgovini namještaja gdje je isti kupljen.

Direktszolgáltatunk vasalatók esetén

HU Ha hiányzik egy vasalat, ezt a kártyát közvetlenül elküldheti az alább található címre. Azonban csak a vasalatókat tudunk így küldeni. Amennyiben másfajta reklamációt áll fenn bútoráruháztól illetően, forduljon közvetlenül a bútorházhoz.

Naš priamy servis pre časti kovania

SK Ak by Vám chýbala niekaka časť kovania, môžete poslať túto servisnú kartu pošou e-mailom na nižšie uvedenú adresu. Diely kovania vieme poslať iba týmto spôsobom. Ak by ste mali inú reklamáciu ohtľadom Vášho nábytku, obráťte sa priamo na Vašu predajňu nábytku.

Naše direktne uslužne storitve za okovje

SLO Če vam manjka kakšno okovje, lahko to servisno kartico pošljete po e-pošti direktno na spodnji naslov. Po tej poti vam lahko pošljemo samo okovje. Če želite reklamirati kakšen drug del pohištva, se obrnite neposredno na vašo trgovino pohištva.

Servicio-ul nostru direct pentru feronerie

RO În cazul în care vă lipseşte o piesă de feronerie puteţi să trimiteţi direct acest card de service prin e-mail la adresa de mai jos. Noi nu putem expedia piese de feronerie decât pe această cale. Dacă aveţi o altă reclamaţie referitoare la piesa de mobilier, atunci vă rugăm să vă adresaţi direct la magazinul dvs. de mobilă.

Наш прямой сервис для поставок фурнитуры

RUS Если окажется, что Вам не хватает того или иного элемента фурнитуры, Вы можете отправить сервисную карту по факсу непосредственно на нижеприведенный адрес электронной почты. Однако, таким образом мы можем переслать лишь фурнитуру. Если же у Вас возникнут иные претензии относительно приобретенной мебели, пожалуйста, обращайтесь непосредственно в организацию, осуществившую продажу.

Vi direktservice för beslagdelar

S Om du saknar en beslagdel kan du skicka detta servicekort direkt till e-postadressen som anges nedan. Tank på att detta är den enda möjligheten att skicka beslagdelar till dig. Om du vill reklamera ditt möbel av en annan anledning måste du kontakta ditt möbelhus direkt.

Nuestro servicio directo para accesorios

ES Si le falta algún accesorio, puede enviar esta tarjeta de servicio directamente a la siguiente dirección. No obstante, por este método solo podemos enviar accesorios. Si tiene alguna otra objeción sobre su mueble, consulte directamente con su mueblería.

Donatilar için doğrudan servisimiz

TR Bir donatınız eksikse bu servis kartını doğrudan aşağıda bulunan adrese doğrudan mail yazabilirsiniz. Sadece bu yolla donatıları gönderebiliriz. Mobilyanızda başka şikayetleriniz varsa lütfen doğrudan mobilya satıcınıza danışın.

MHC1	x1	411	389	15	1/1
MHC2	x1	411	389	15	1/1
MHC3	x1	1244	368	15	1/1
MHC4	x1	1339	443	65	1/1
MHC6	x1	196	367	15	1/1
MHC8	x1	1244	368	15	1/1
MHC9	x3	185	368	18	1/1
MHC15	x1	1223	80	15	1/1
MHC16	x2	411	80	22	1/1
MHC18	x4	305	140	15	1/1
MHC19	x2	534	126	15	1/1

MHC20	x2	515	326	3	1/1
MHC21	x1	1256	416	3	1/1
MHC25	x1	382	80	32	1/1
MHC26	x1	382	80	32	1/1
MHC27	x1	1288	80	32	1/1
MHC28	x1	553	210	15	1/1
MHC29	x1	553	210	15	1/1

SIENA 31M

Unser Direktservice für Beschlagteile

Sollte Ihnen ein Beschlagteil fehlen, können Sie diese Servicekarte direkt an die untenstehende Adresse mailen. Wir können allerdings nur Beschlagteile auf diesem Wege verschicken. Sollen Sie eine andere Beanstandung an Ihrem Möbelstück haben, so wenden sie sich bitte direkt an Ihr Möbelhaus.

Our direct order service for fitting

If a fitting part is missing, you can e-mail this service card directly to the address below. However, we can only send fitting parts in this way. If you have any other cause for complaint concerning your item of furniture, please contact your furniture store directly.

Naše primé služby pro kování

Chybí-li vám nějaký díl z kování, můžete tuto servisní kartu odeslat e-mailem přímo na níže uvedenou adresu. Touto cestou však můžeme rozeslat jen díly kování. Pokud byste reklamovali jiný díl nábytku, obraťte se přímo na svého prodejce nábytku.

Bien étudier la notice de montage

S'il vous manque une ferrure, veuillez envoyer directement la présente carte service à l'adresse e-mail indiquée ci-dessous. Cependant, ceci nous permet uniquement d'envoyer des ferrures. Pour tout autre type de réclamation concernant votre meuble, veuillez contacter directement votre magasin d'ameublement.

Il nostro servizio diretto per l'ordine della ferramenta

Qualora Vi dovesse mancare un pezzo di fissaggio, allora Vi preghiamo di inviare questa carta di servizio immediatamente all'indirizzo sottostante. Possiamo inviare i pezzi di fissaggio solamente per mezzo di questo procedimento. Qualora dovesse avere qualche altra reclamazione in merito al mobile, allora Vi preghiamo di rivolgerVi direttamente al Vostro Negozio di mobili.

Нашата директна услуга за обкоя

Ако липсват части от комплекта, попълнете настоящата сервисна карта и ни я изпратете на e-mail адреса, посочен по-долу. По този начин можем да доставяме само липсващи елементи от обкоя. Ако установите други дефекти по мебелите, Ви съветваме да се обърнете към мебелната къща/магазин, от който сте закупили стоката.

Onze directservice voor losse onderdelen

Wanneer er een onderdeel ontbreekt, kunt u deze servicekaart direct aan onderstaand e-mailadres sturen. Wij kunnen alleen de weg echter alleen beslagdelen versturen. Mocht u een ander probleem aan uw meubel hebben, verzoeken wij u contact op te nemen met uw meubeldealer.

Nasz bezpośredni serwis czeski montażowych

Jeżeli brakuje części koniecznych do montażu, prosimy o przesłanie nam niniejszej karty serwisowej na niżej podany adres e-mailowy. W ten sposób możemy przesłać Państwu tylko brakujące części. W przypadku innych reklamacji dotyczących mebla, prosimy zgłosić się do salonu meblowego, w którym został dokonany zakup.

Servis za okove

U slučaju da nedostaje neki od dijelova molimo vas da na dolje navedenu mail adresu pošaljete ovaj servisni obrazac. Na ovaj način mogu se dostaviti samo okovi. U slučaju da imate dodatne prigovore vezane uz komad namještaja molimo vas da se obratite izravno trgovini namještaja gdje je isti kupljen.

Direktszolálatunk vasalatok esetén

Ha hiányzik egy vasalát, ezt a kártyát közvetlenül elküldheti az alább található címre. Azonban csak vasalatókat tudunk így küldeni. Amennyiben másfajta reklamáció al fenn bútorárbaját illetően, forduljon közvetlenül a bútorházhoz.

Náš priamy servis pre časti kovania

Ak by Vám chýbala nejaká časť kovania, môžete poslať túto servisnú kartu pošou e-mailom na nižšie uvedenu adresu. Díly kovania vieme pošou iba týmto spôsobom. Ak by ste mali inú reklamáciu oľhadom Vášho nábytku, obraťte sa priamo na Vašu predajňu nábytku.

Naše direktne uslužne storitve za okovje

Ce vam manjka kakšno okovje, lahko to servisno kartico pošljete po e-pošti direktno na spodnji naslov. Po tej poti vam lahko pošljemo samo okovje. Če želite reklamirati kakšen drug del pohištva, se obrnite neposredno na vašo trgovino pohištva.

Service-ul nostru direct pentru feronerie

În cazul în care vă lipsește o piesă de feronerie puteți să trimiteți direct acest card de service prin e-mail la adresa de mai jos. Noi nu putem expedia piese de feronerie decât pe această cale. Dacă aveți o altă reclamație referitoare la piesa de mobilier, atunci vă rugăm să vă adresați direct la magazinul dvs. de mobilă.

Наш прямой сервис для поставок фурнитуры

Если окажется, что Вам не хватает того или иного элемента фурнитуры, Вы можете отправить сервисную карту по факсу непосредственно на нижеприведенный адрес электронной почты. Однако, таким образом мы можем пересылать лишь фурнитуру. Если же у Вас возникли иные претензии относительно приобретенной мебели, пожалуйста, обращайтесь непосредственно в организацию, осуществившую продажу.

Vir direktservice för beslagsdelar

Om du saknar en beslagsdel kan du skicka detta servicekort direkt till e-postadressen som anges nedan. Tänk på att detta är den enda möjligheten att skicka beslagsdelar till dig. Om du vill reklamera din möbel av en annan anledning måste du kontakta ditt möbelför direkt.

Nuestro servicio directo para accesorios

Si le falta algún accesorio, puede enviar esta tarjeta de servicio directamente a la siguiente dirección. No obstante, por este método solo podemos enviar accesorios. Si tiene alguna otra objeción sobre su mueble, consulte directamente con su mueblería.

Donatilar için doğrudan servisimiz

Bir donatınız eksikse bu servis kartını doğrudan aşağıda bulunan adrese doğrudan mail yazabilirsiniz. Sadece bu yolla donatılar gönderiliriz. Mobilyanızda başka şikayetleriniz varsa lütfen doğrudan mobilya satıcınıza danışın.

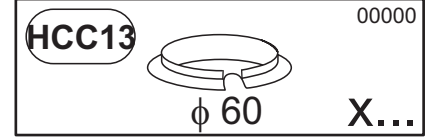
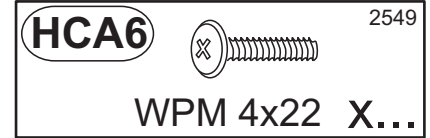
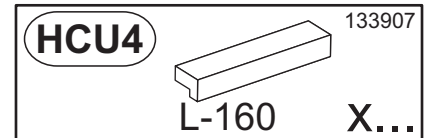
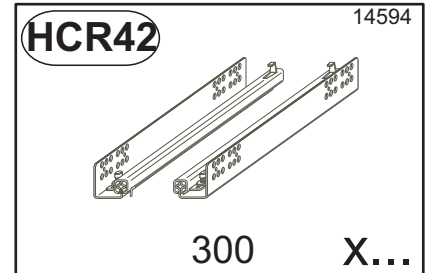
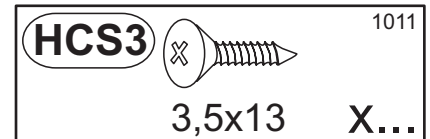
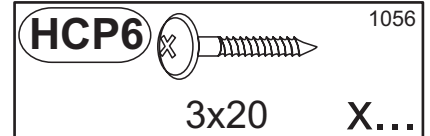
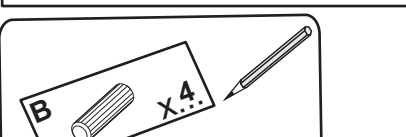
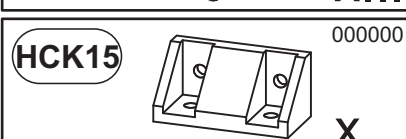
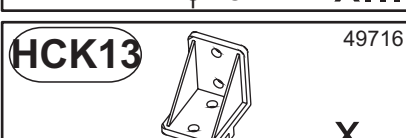
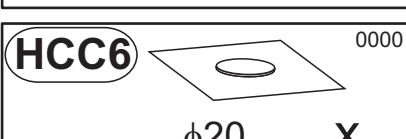
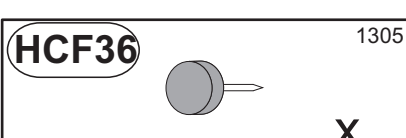
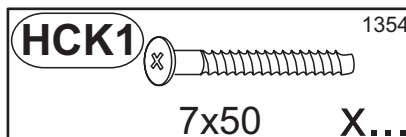
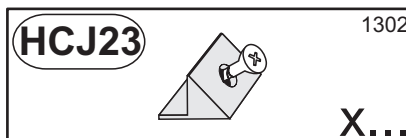
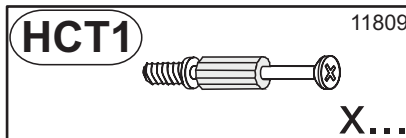
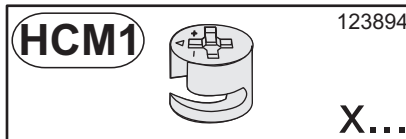
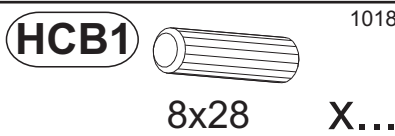

SIENA 41M

OPTION L

OPTION R

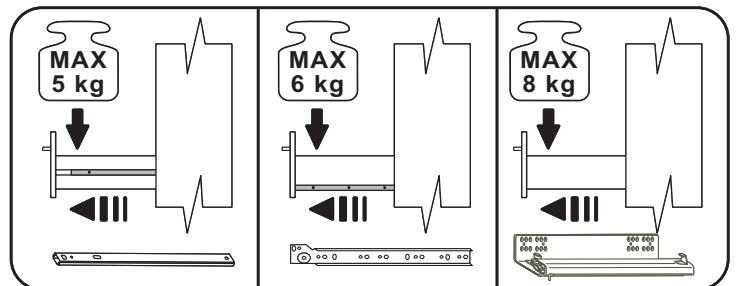
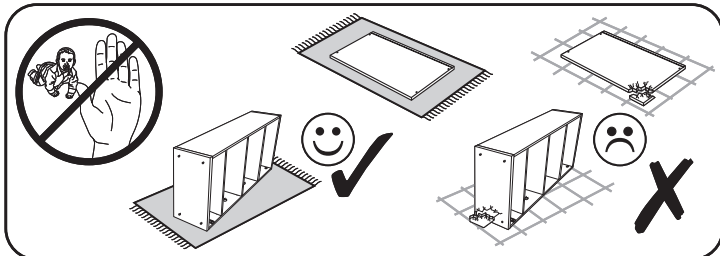
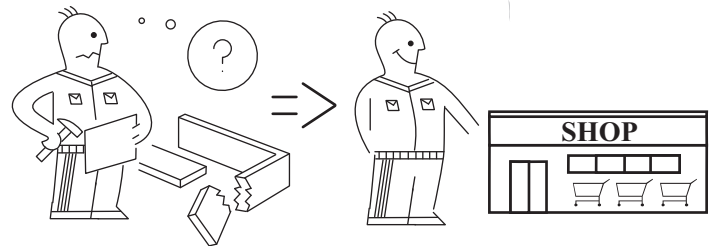
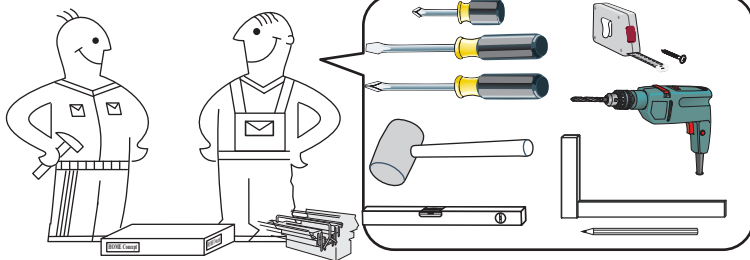
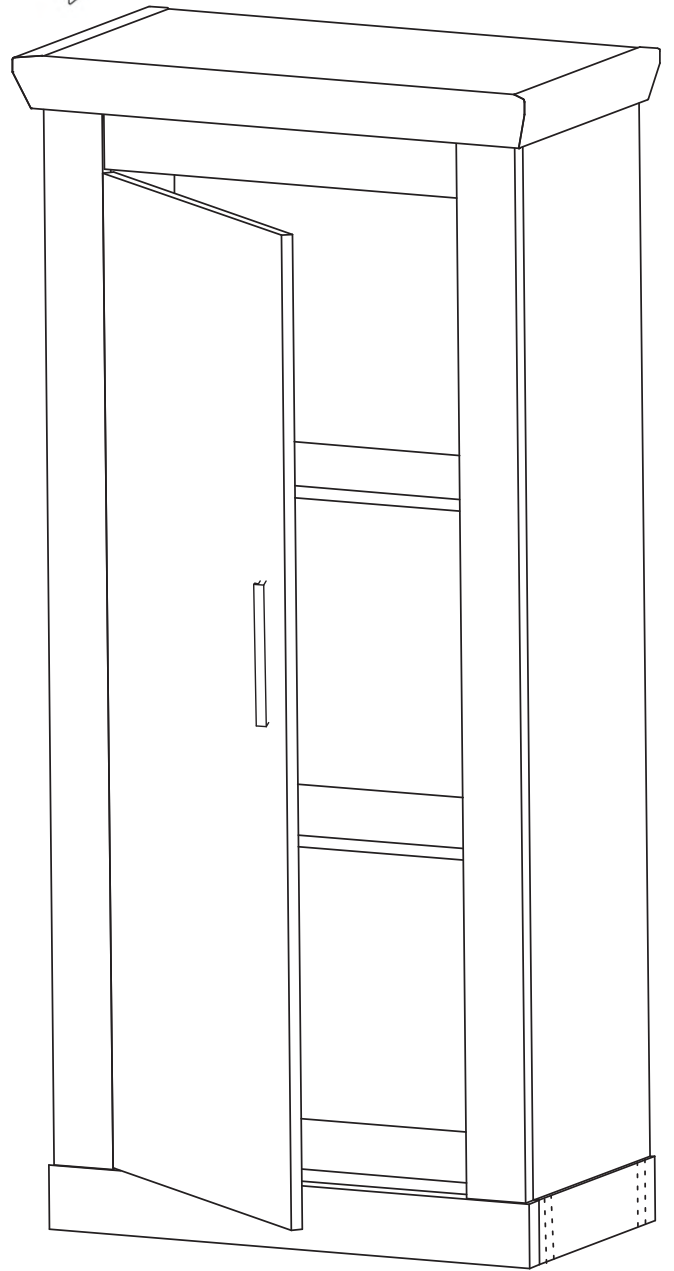
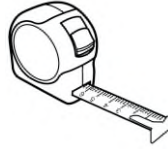
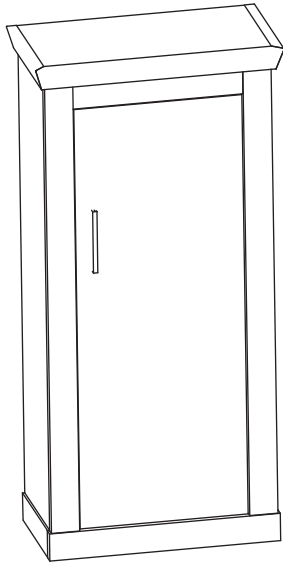
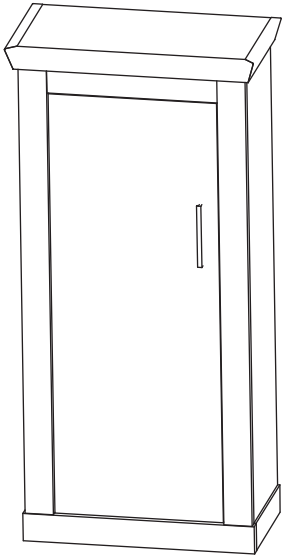

SIENA 41M

max.



MHC3

MHC4

MHC8

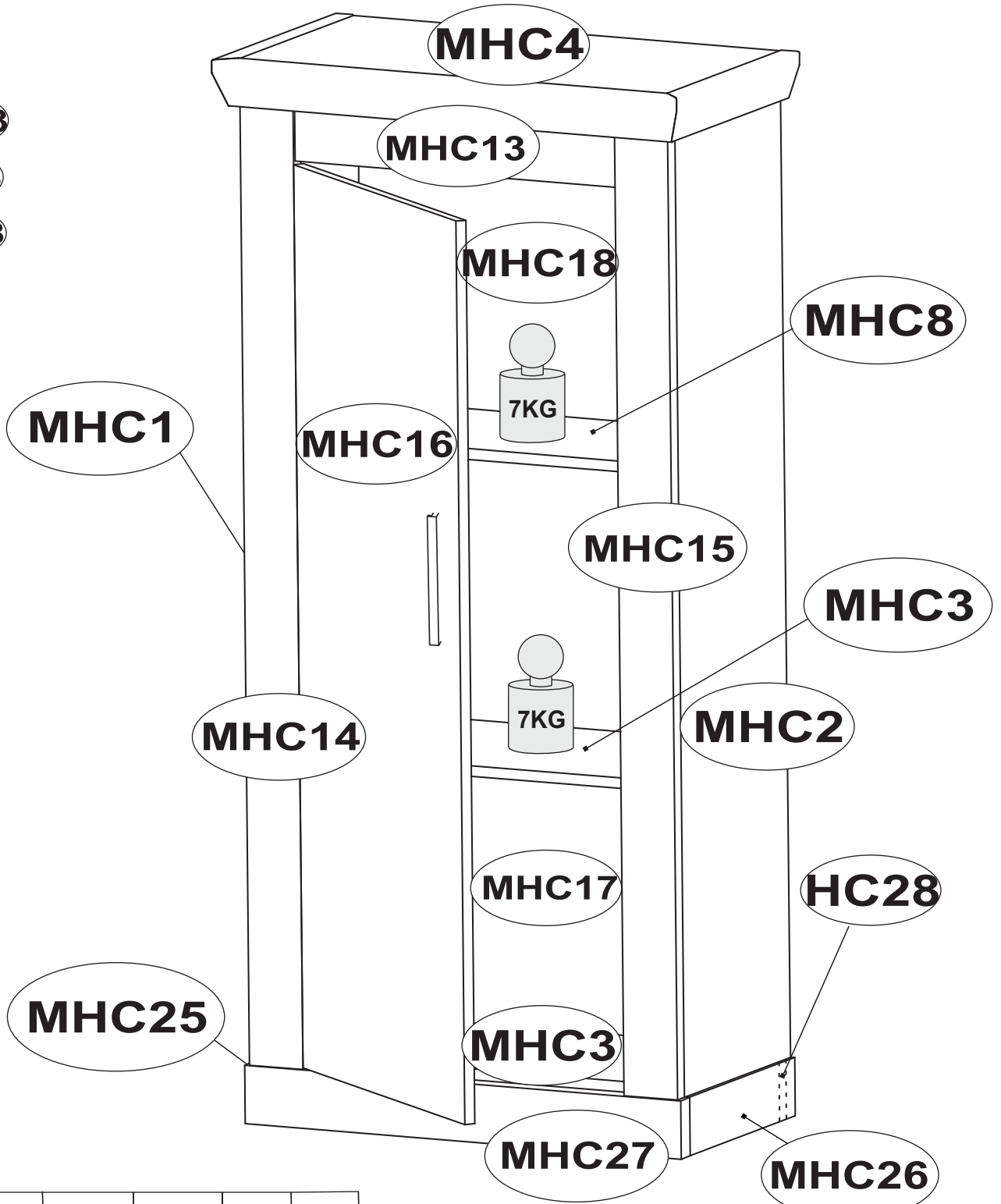



MHC1	x1	1361	320	15	1/1
MHC2	x1	1361	320	15	1/1
MHC3	x2	611	299	15	1/1
MHC4	x1	705	373	65	1/1
MHC8	x1	610	267	15	1/1
MHC13	x1	483	124	18	1/1
MHC14	x1	1361	80	22	1/1
MHC15	x1	1361	80	22	1/1

MHC16	x1	1231	477	15	1/1
MHC17	x1	421	623	3	1/1
MHC18	x1	945	623	3	1/1
MHC25	x1	313	80	32	1/1
MHC26	x1	313	80	32	1/1
MHC27	x1	655	80	32	1/1
MHC28	x1	590	80	15	1/1

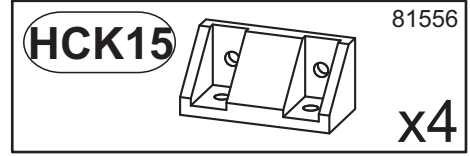
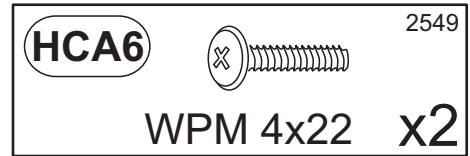
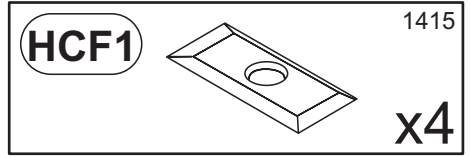
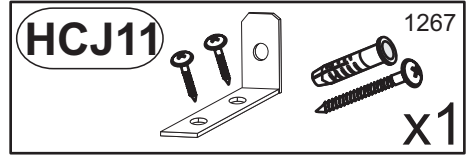
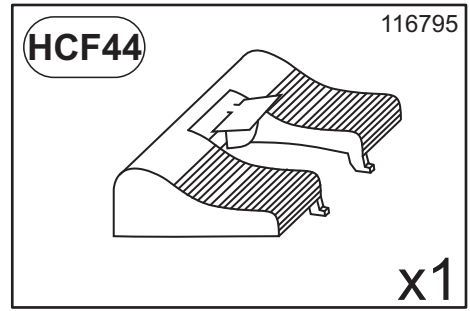
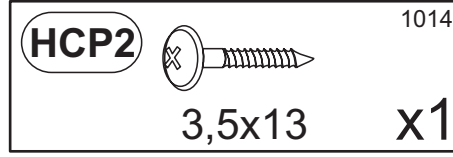
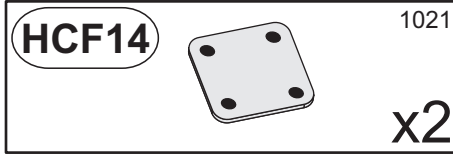
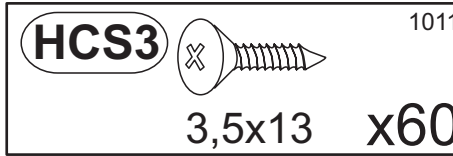
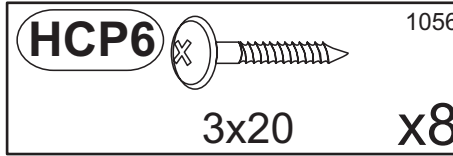
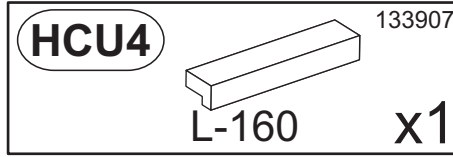
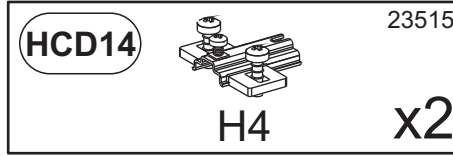
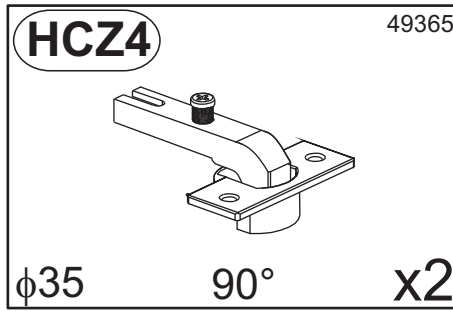
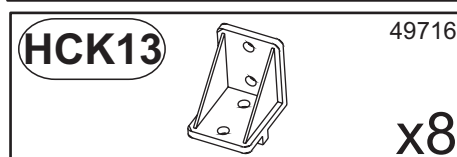
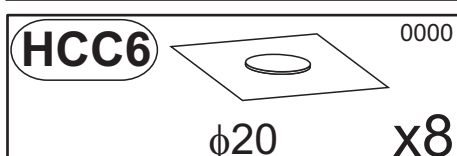
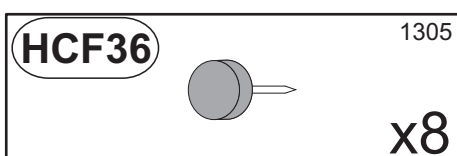
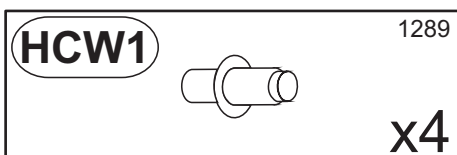
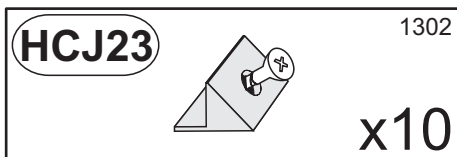
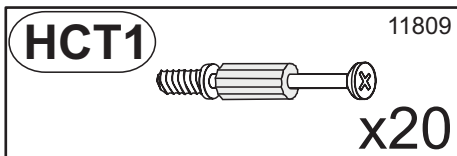
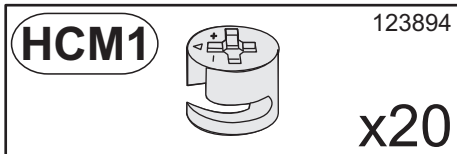
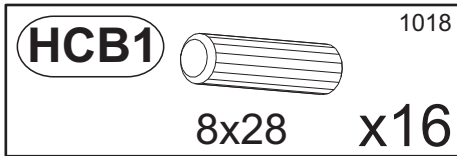
SIENA 41M



1

HCM1		123894	x4
HCK15		81556	x2
HCS3		1011	x4
		3,5x13	x4

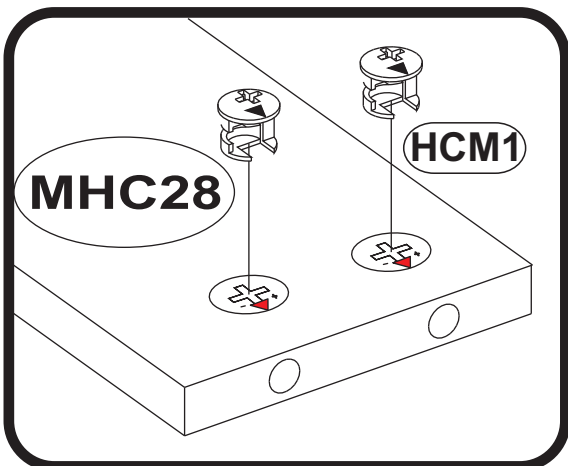
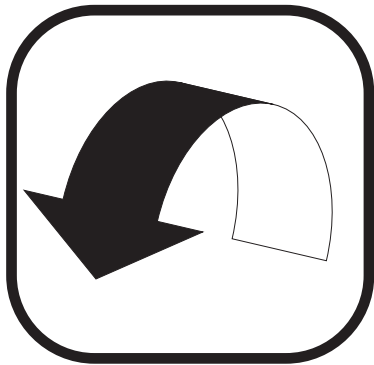
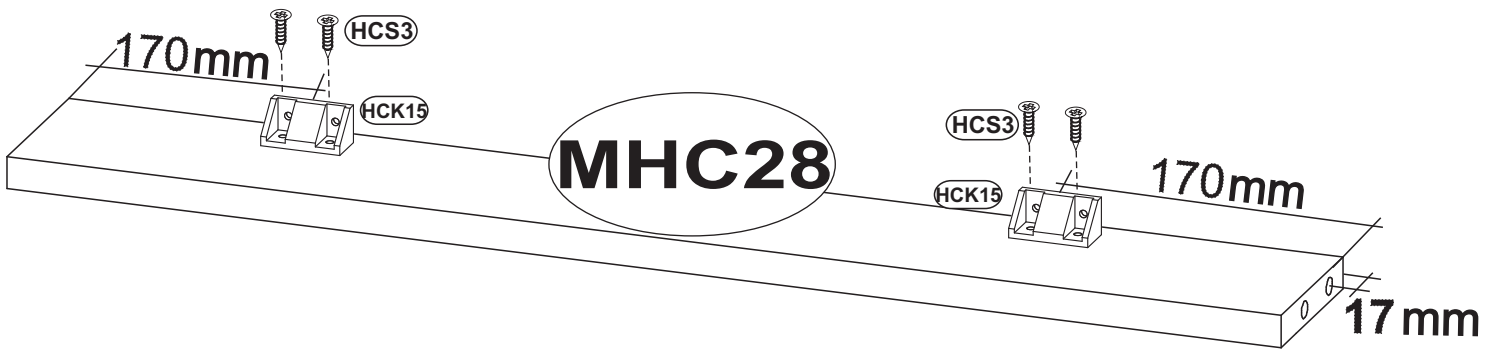
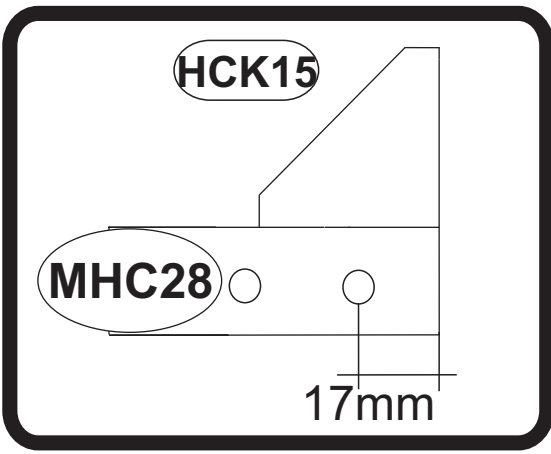
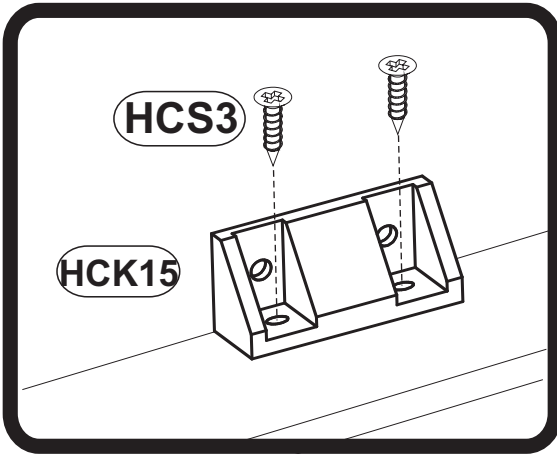

2

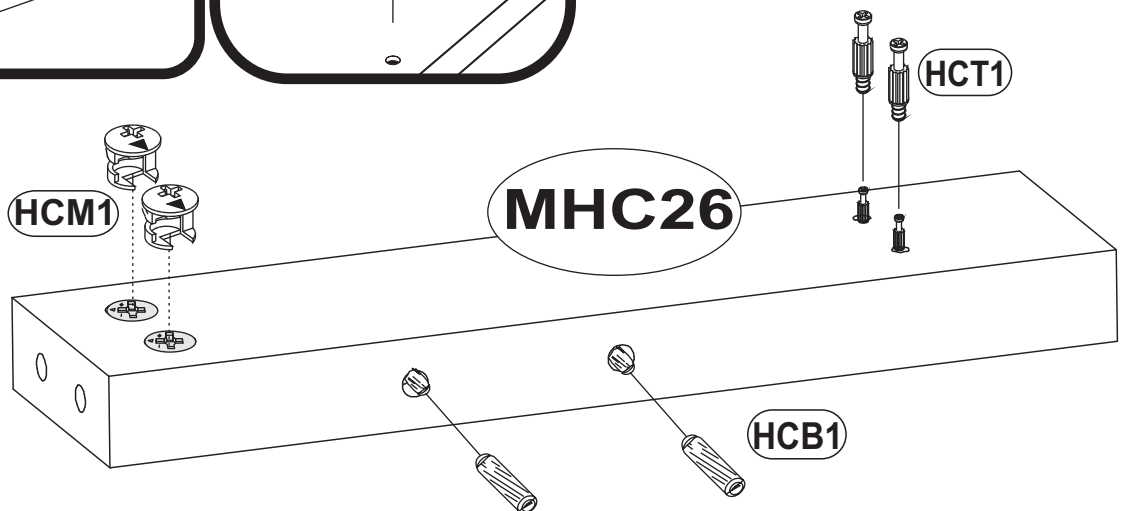
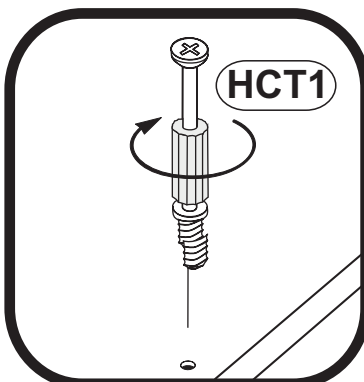
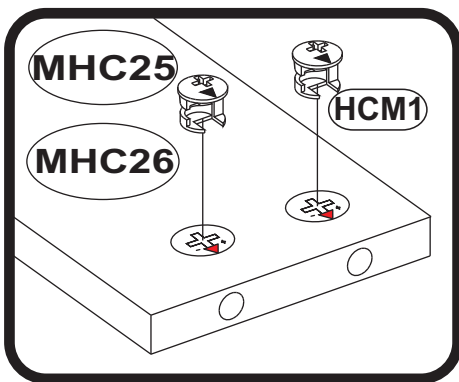
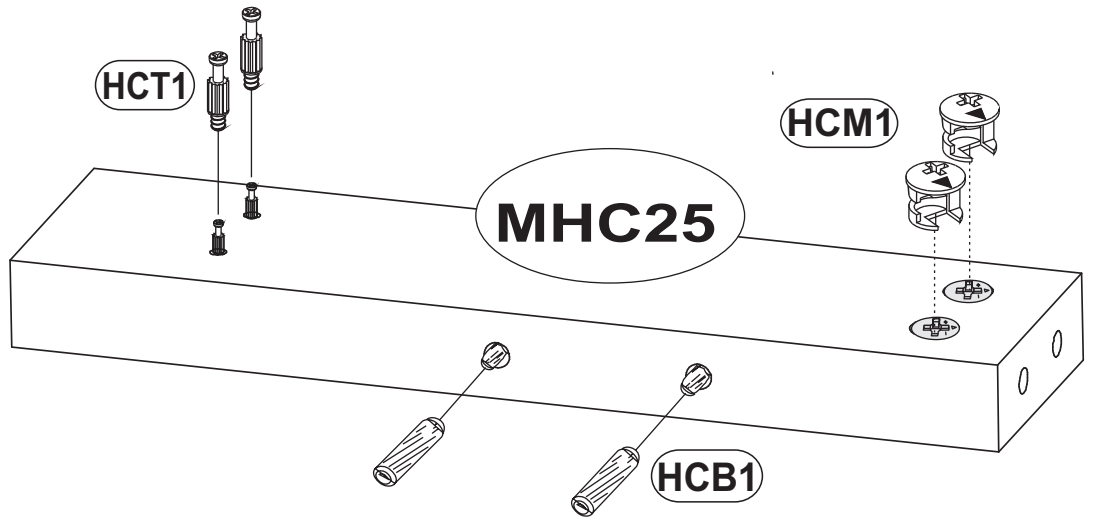
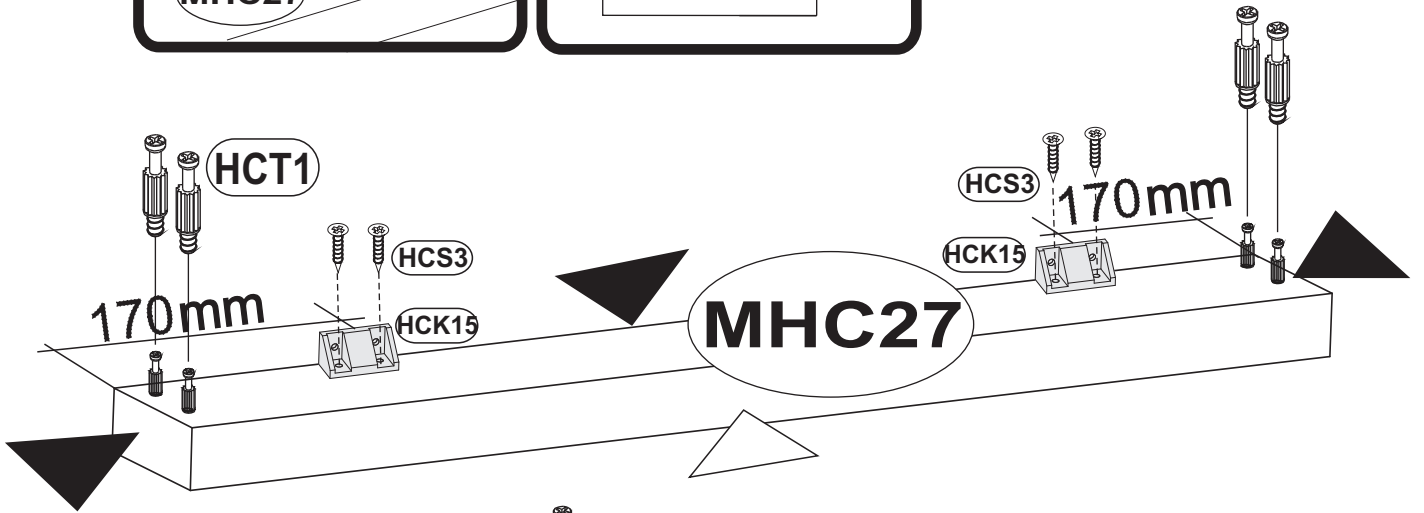
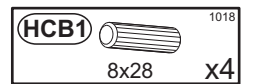
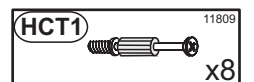
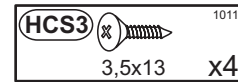
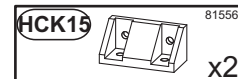
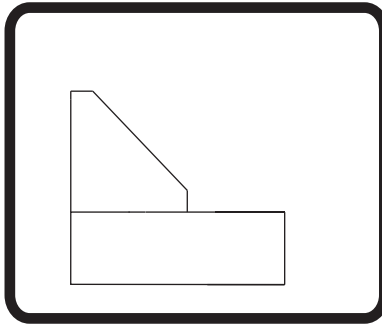
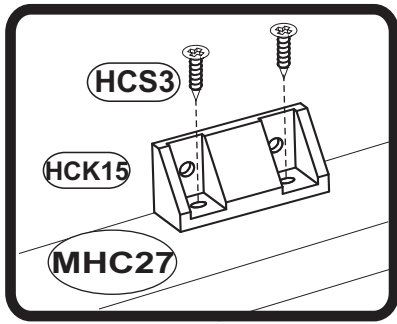

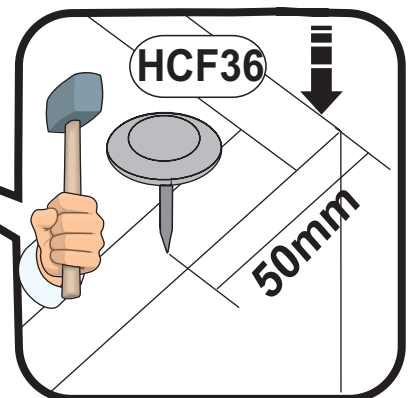
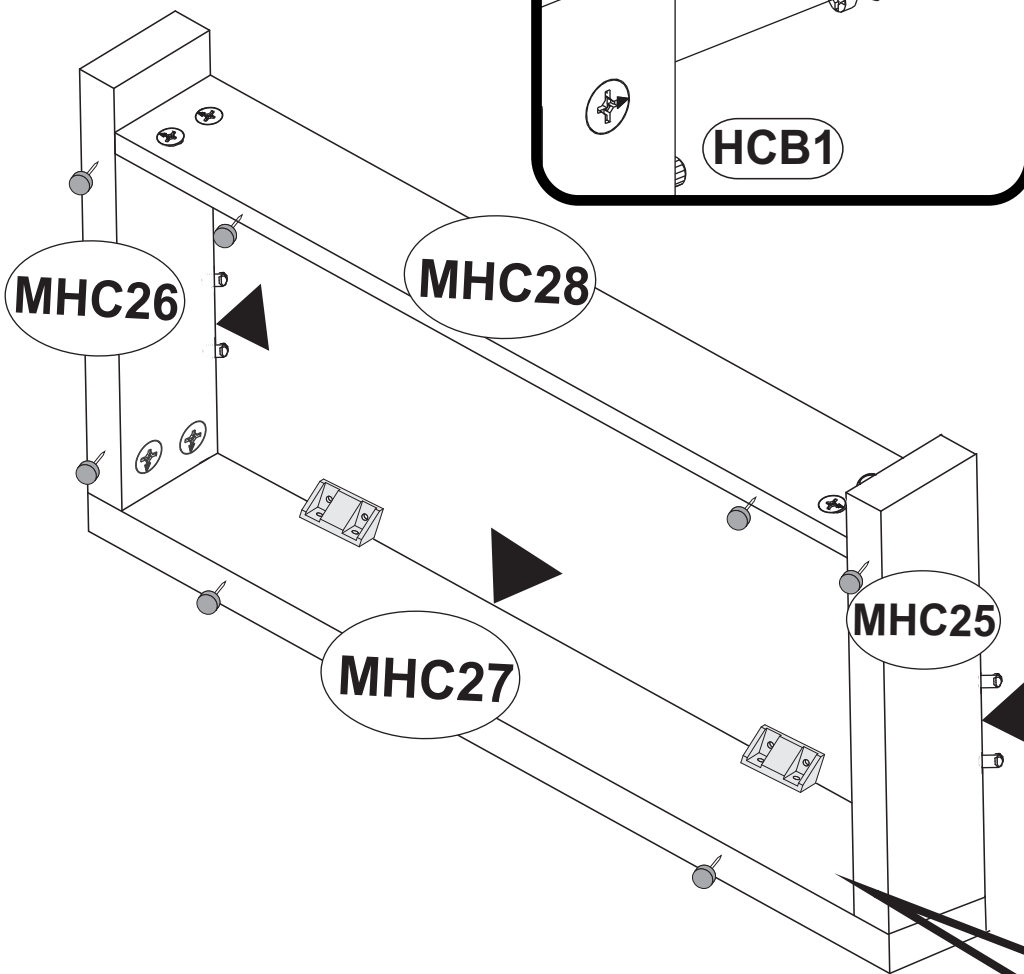
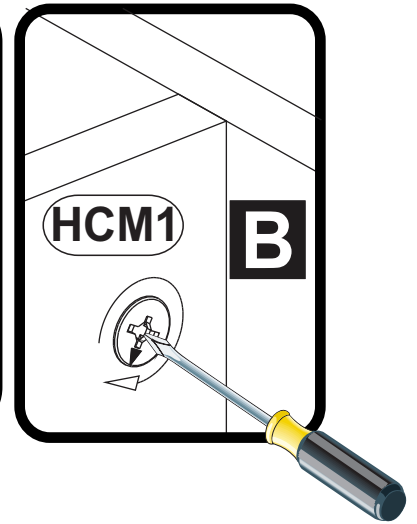
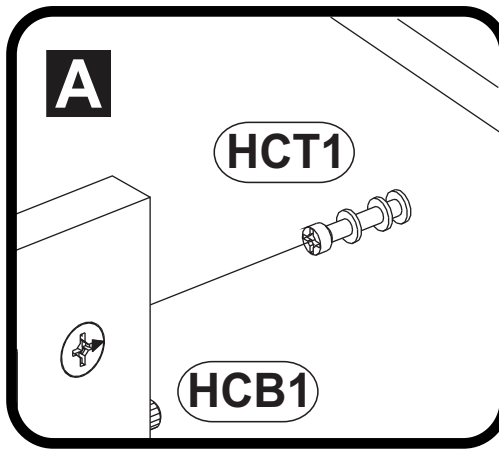
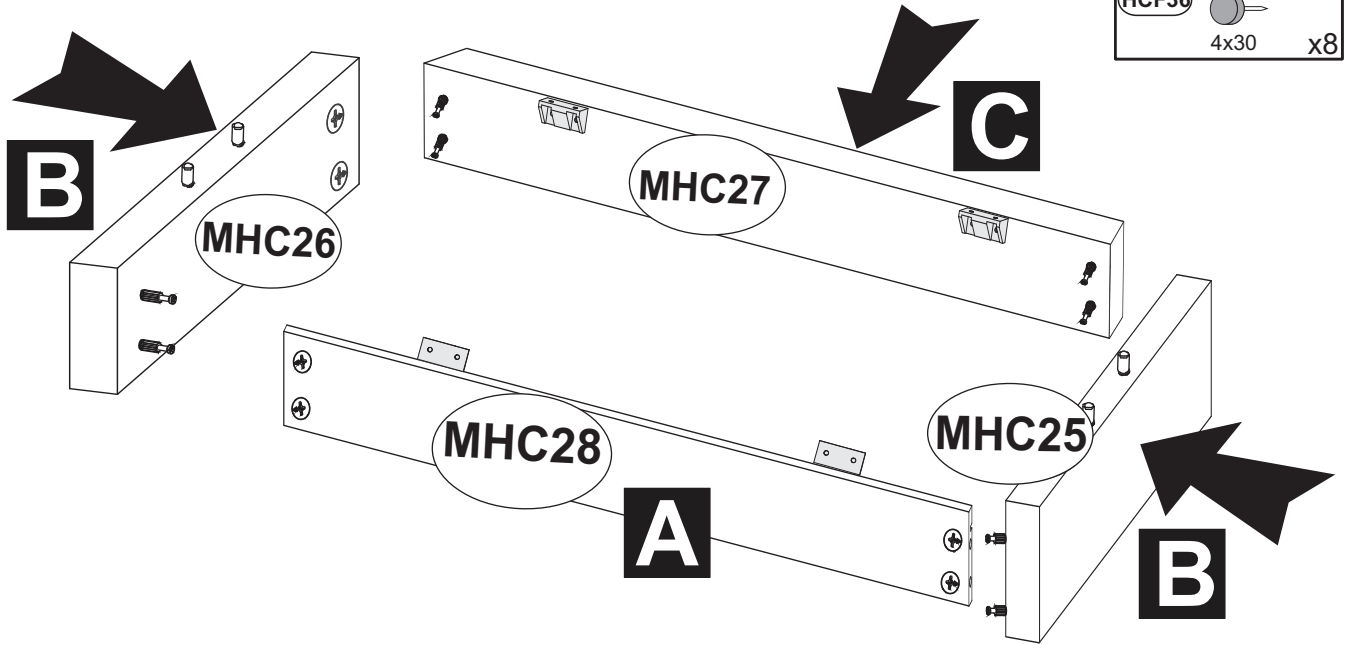

3

HCF36 1305
4x30 x8

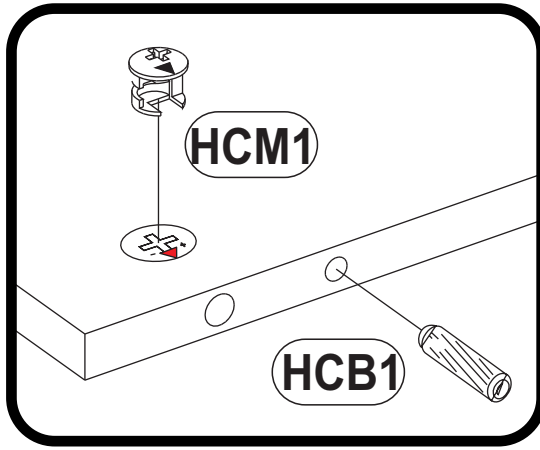
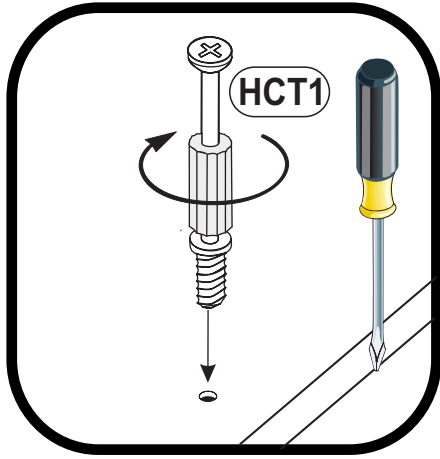

4

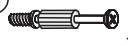

HCB1		1018
	8x28	x4
HCM1		123894
		x4
HCT1		11809
		x8

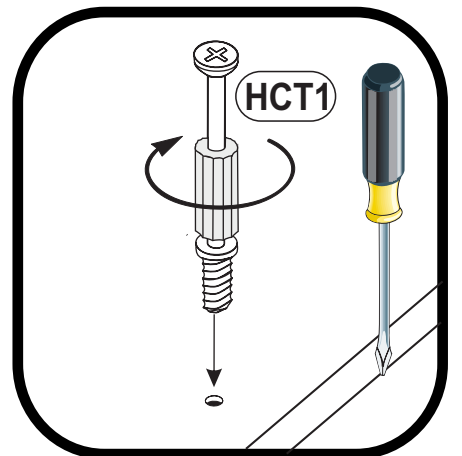
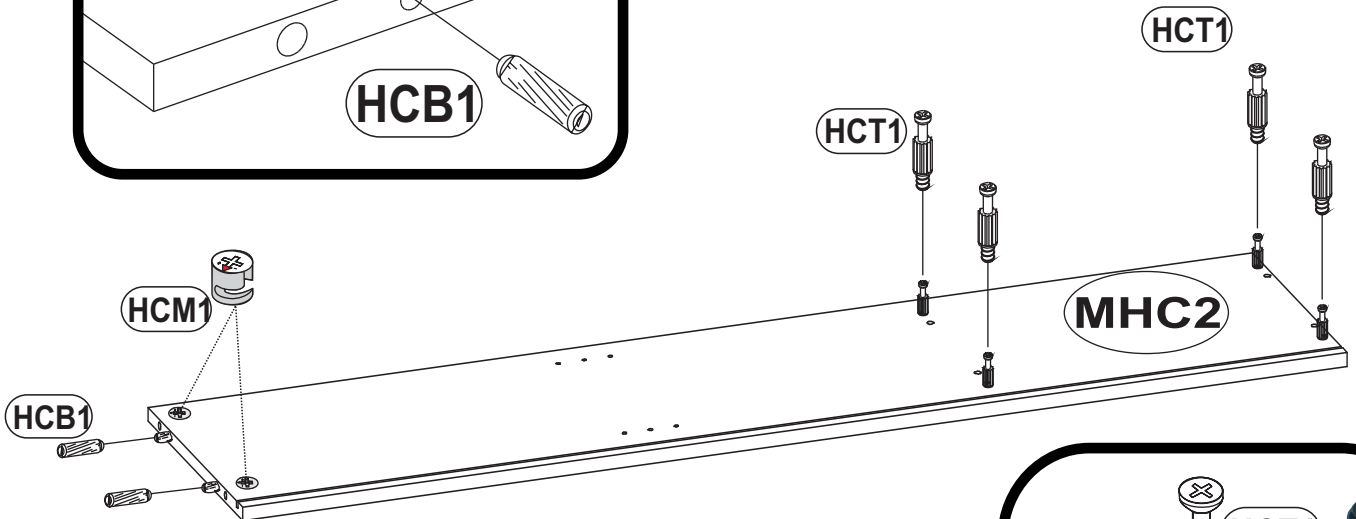
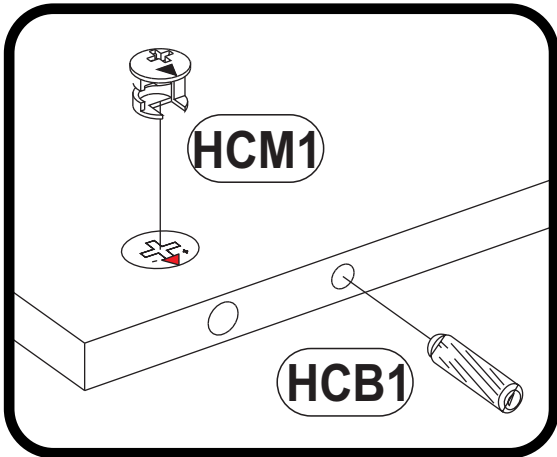
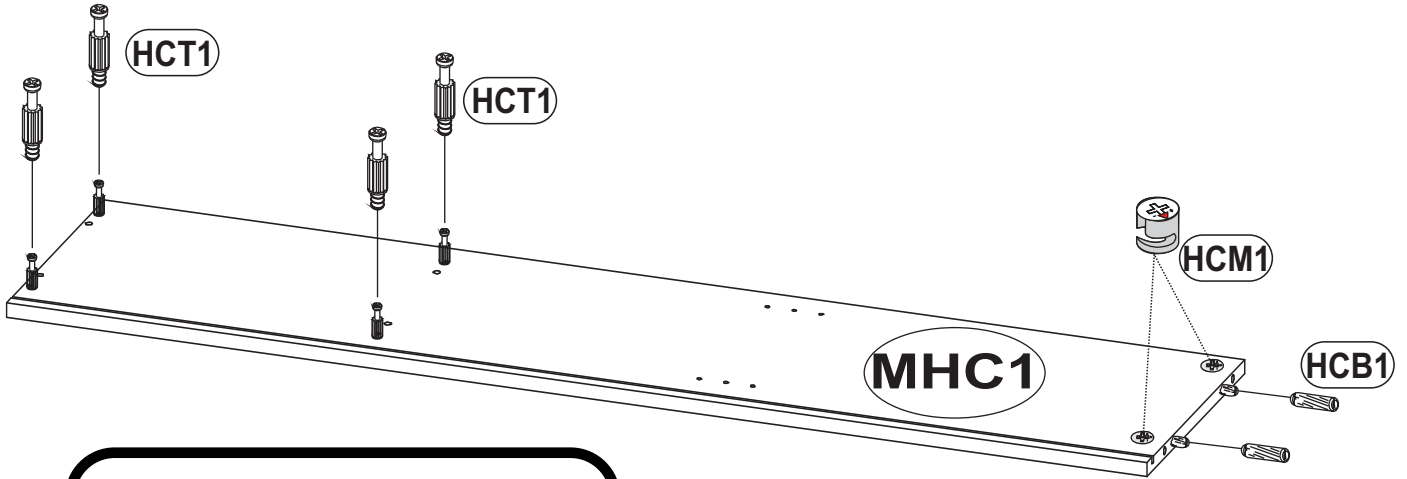

5

OPTION L

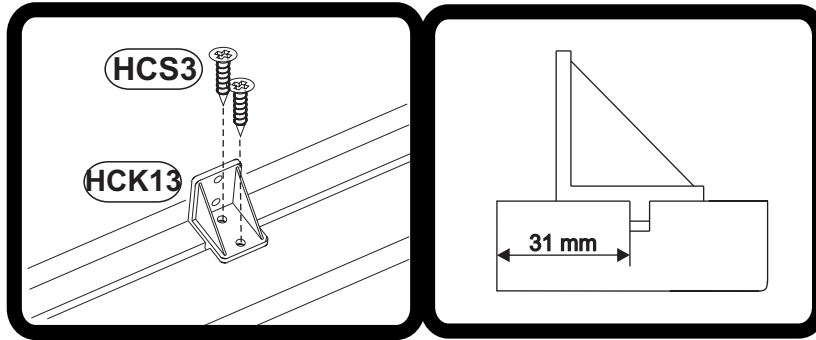
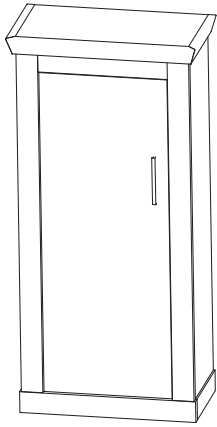

HCS3 1011
3,5x13 x16

HCD14 23515
H4 x2

HCK13 49716
x8

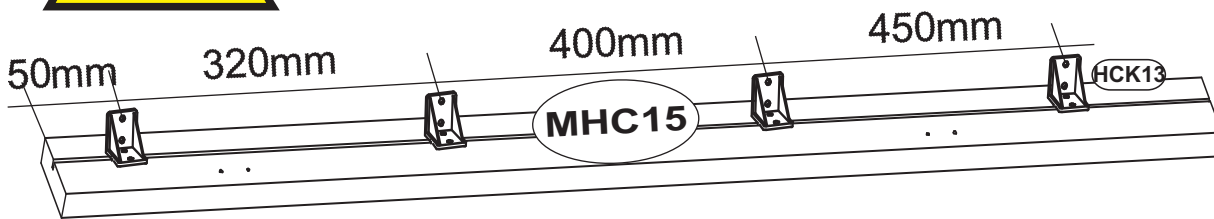
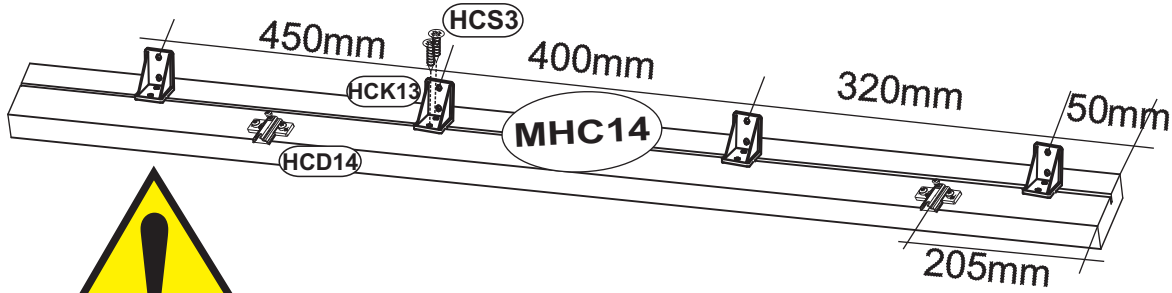
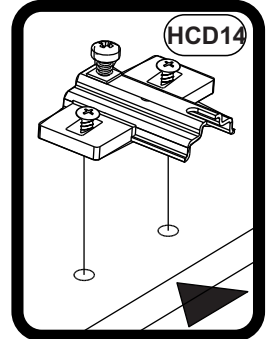

OPTION R

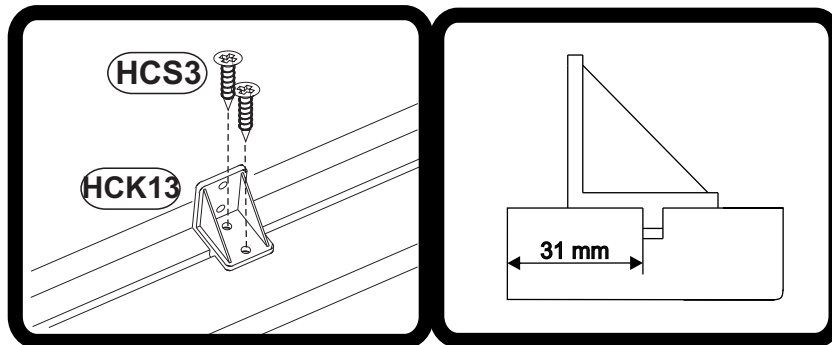
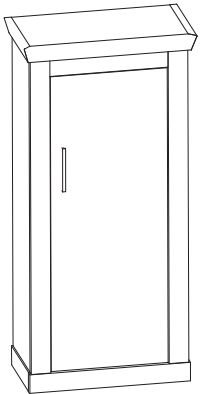



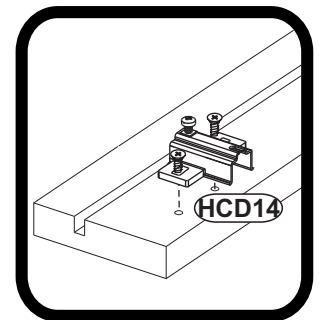
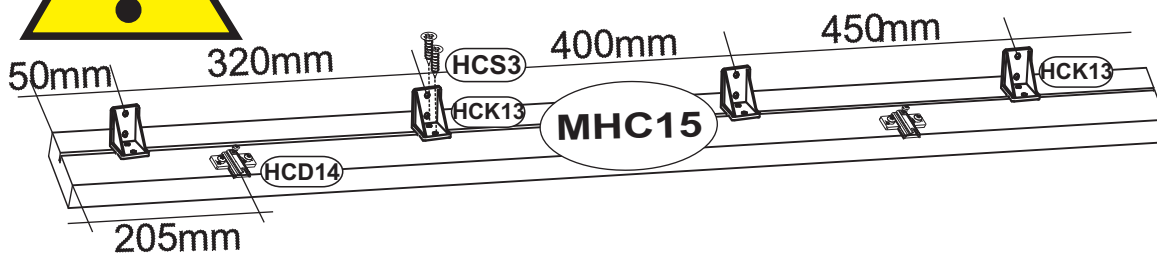
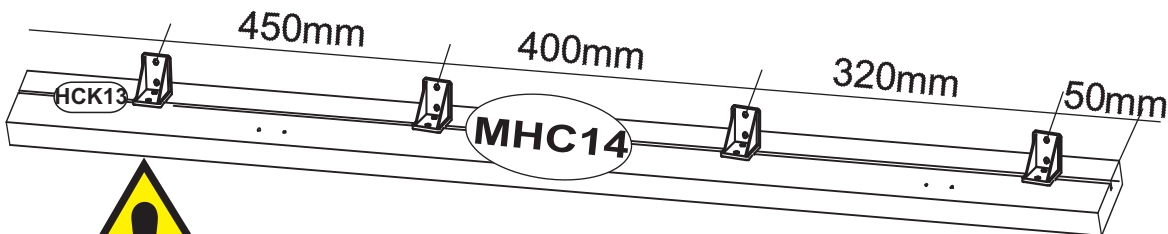

HCS3 1011
3,5x13 x16

HCD14 23515
H4 x2

HCK13 49716
x8



6

HCF14		1021	HCB1		1018
		x2		8x28	x8
HCS3		1011	HCM1		123894
	3,5x13	x4			x8

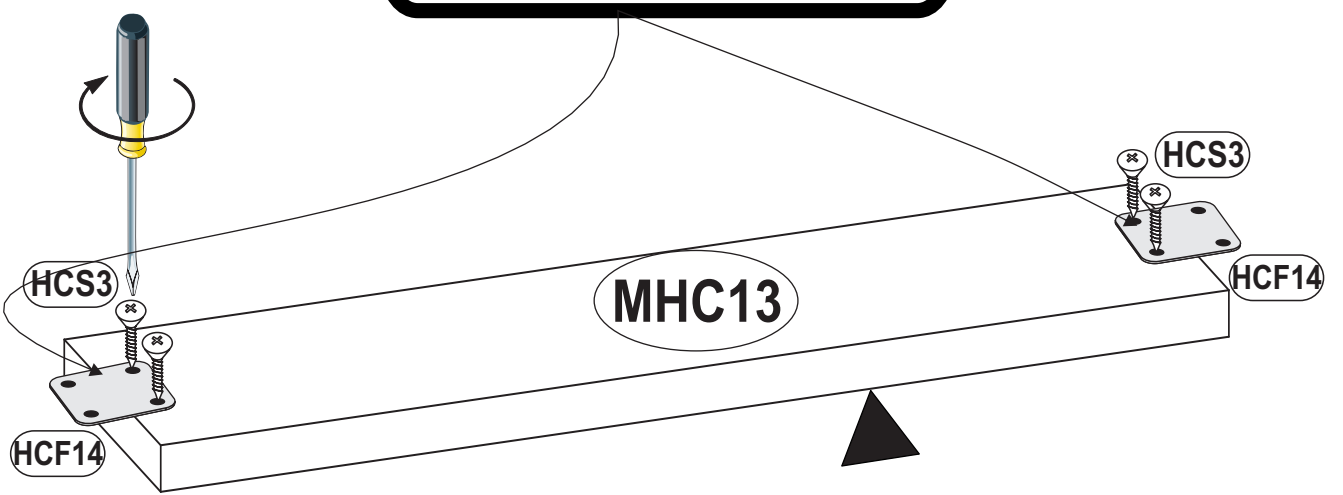
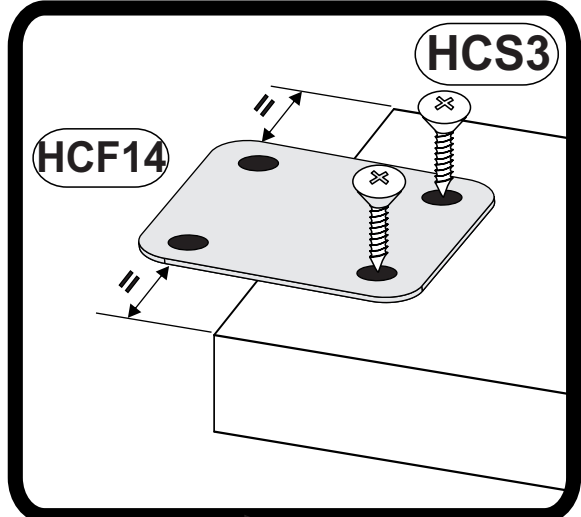
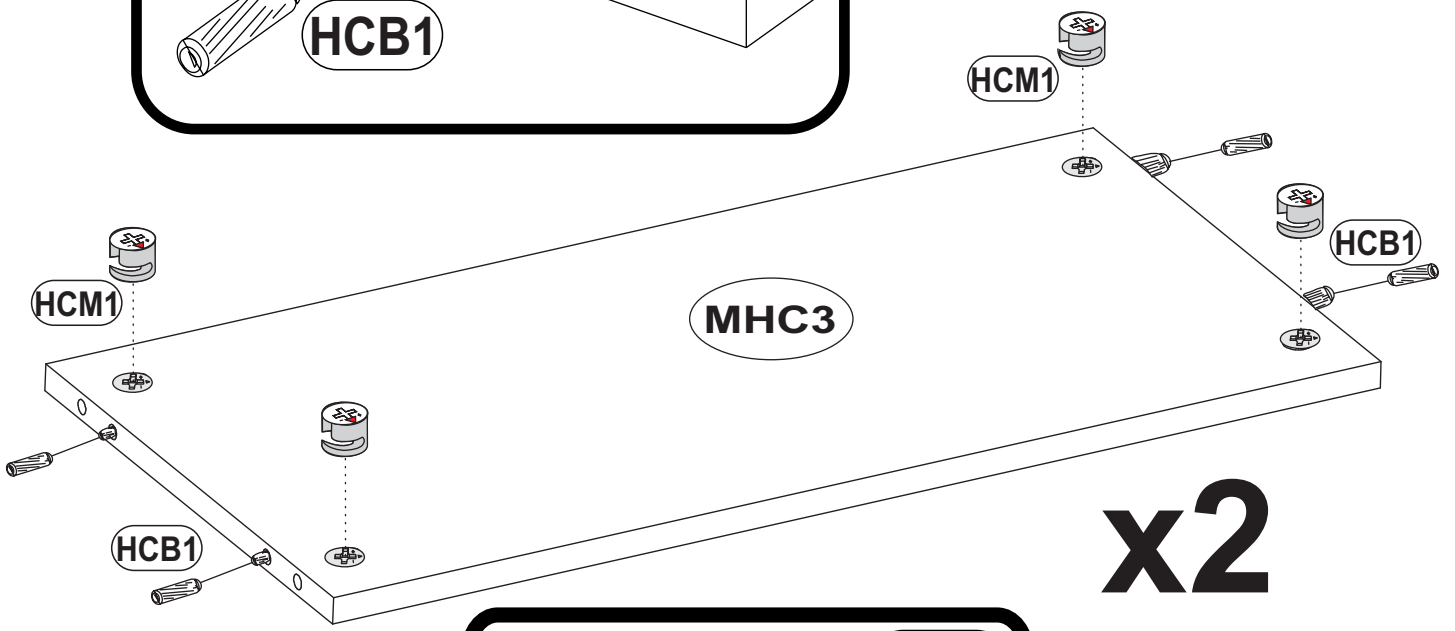
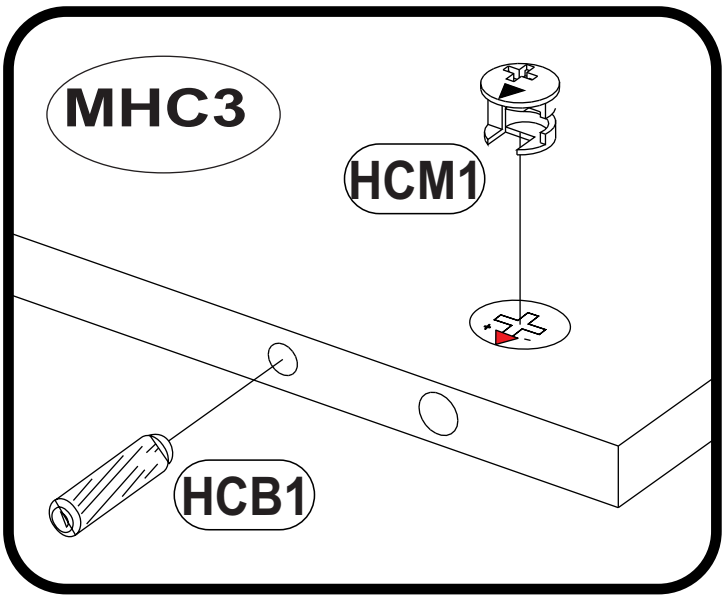



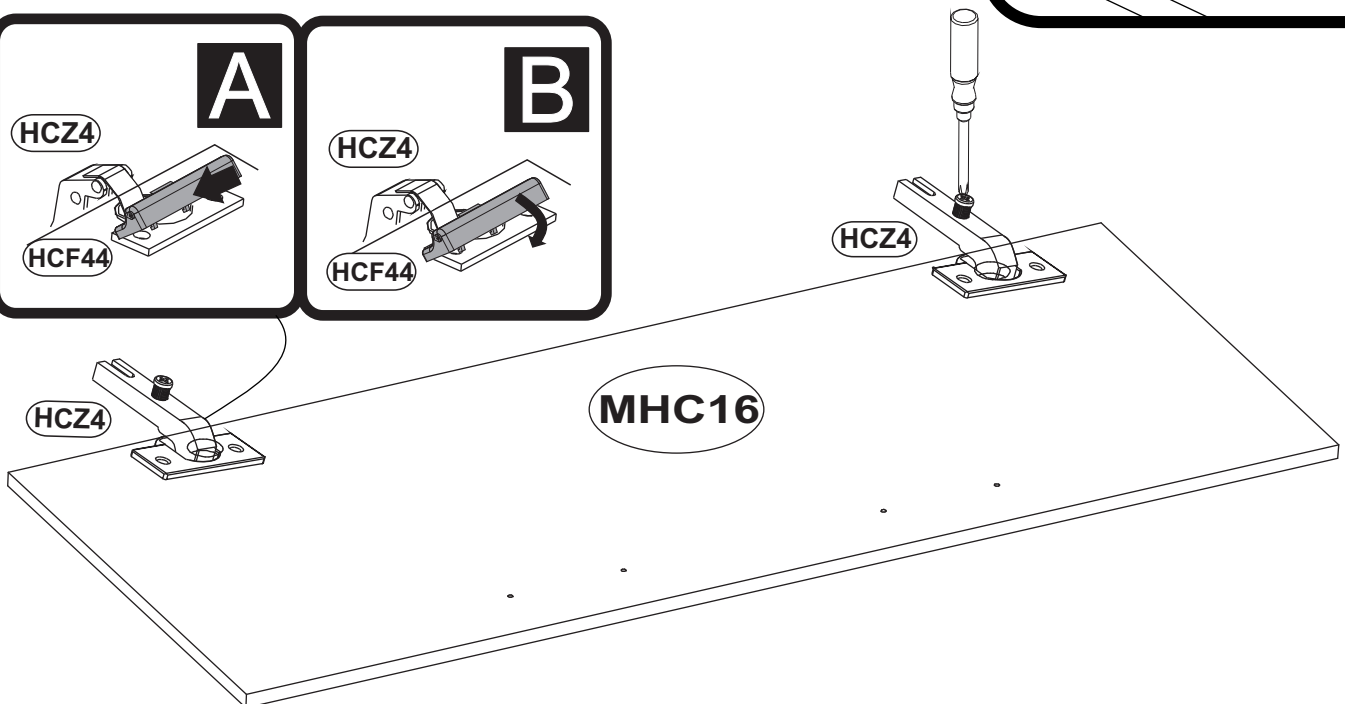
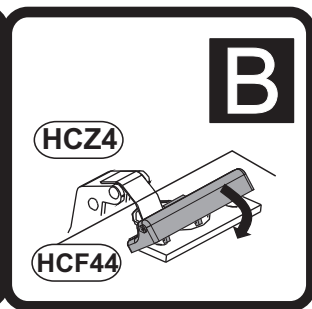
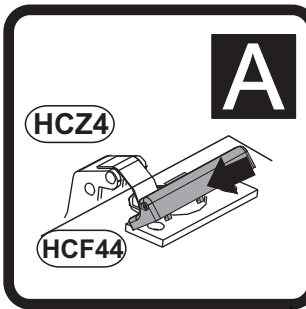
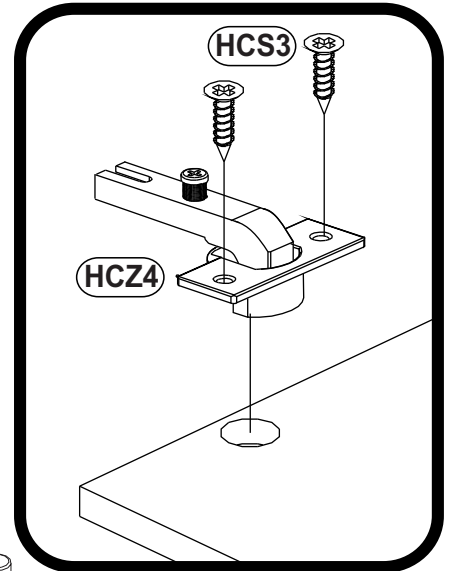
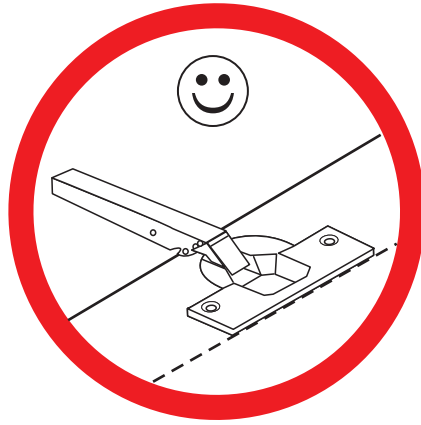
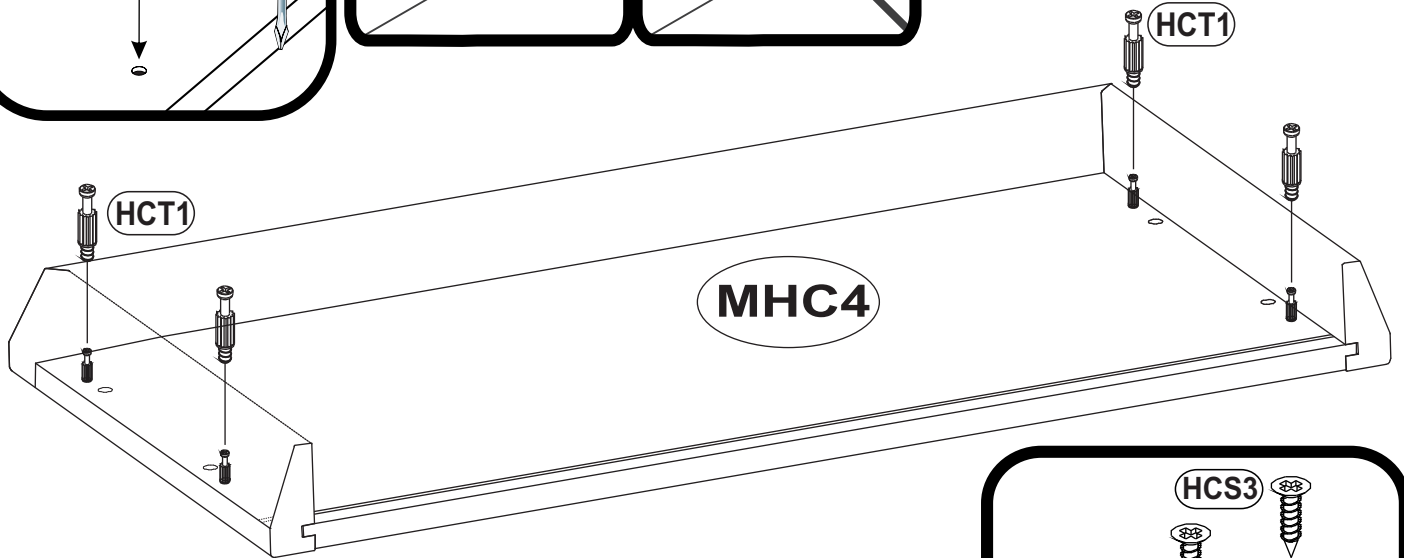
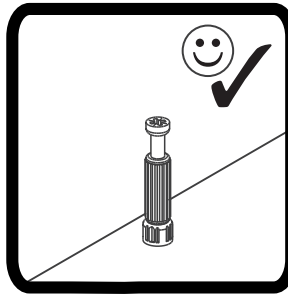
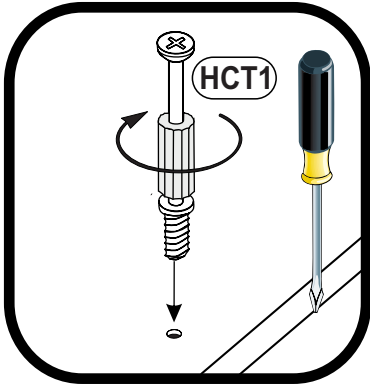
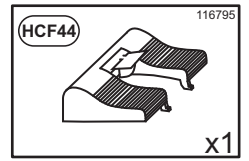
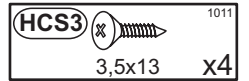
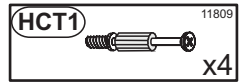
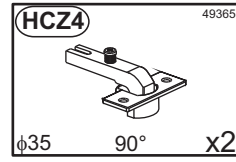

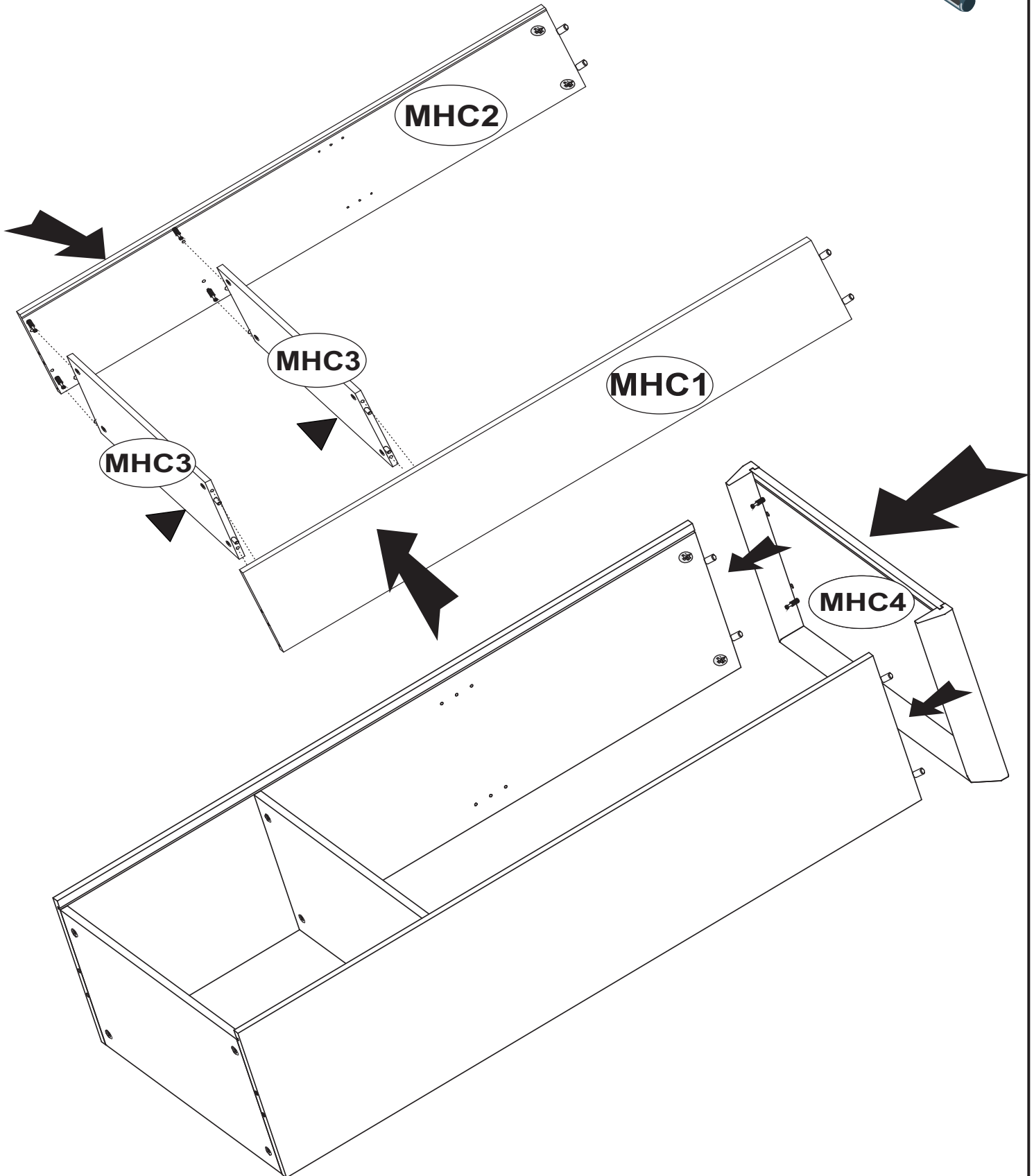
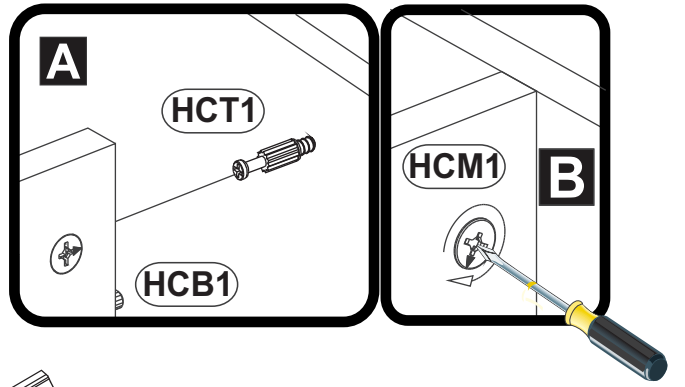
7





9

HCS3 	1011
3,5x13	x8
HCP6 	1056
3x20	x8
HCJ23 	1302
	x10
HCF1 	1415
	x4

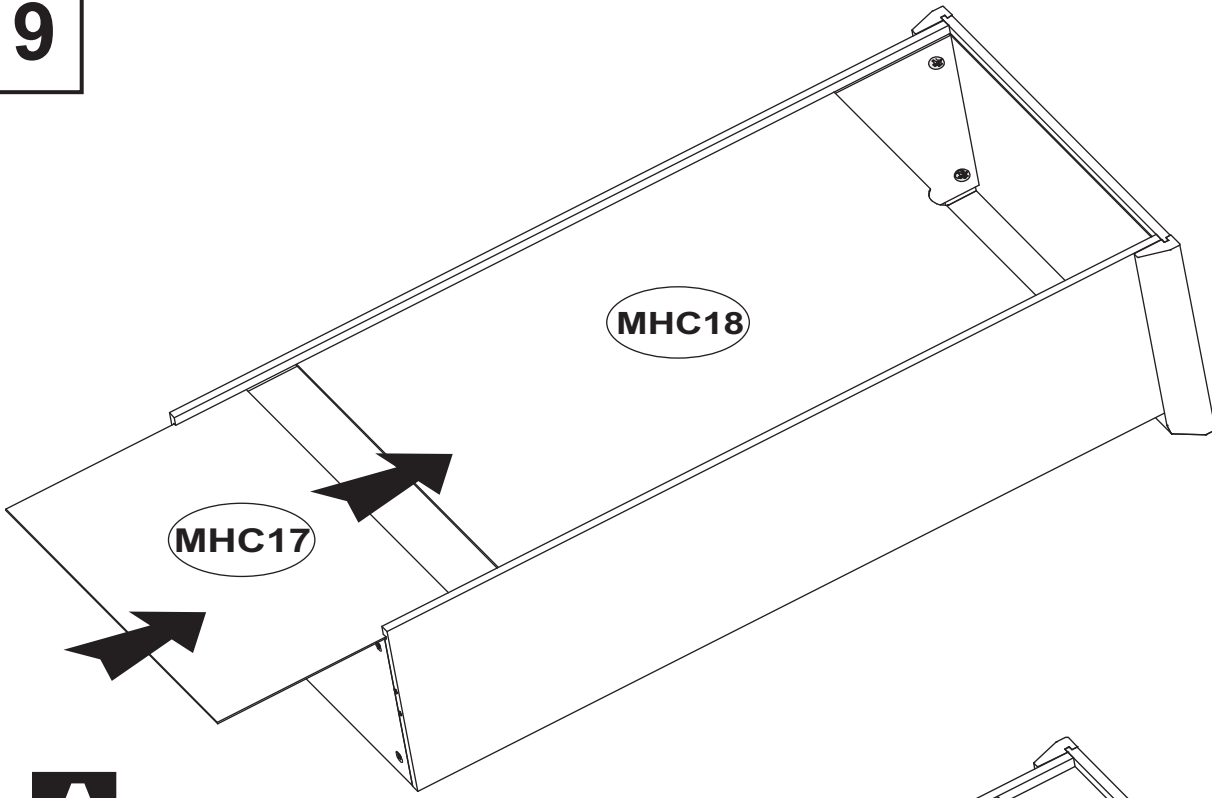

A

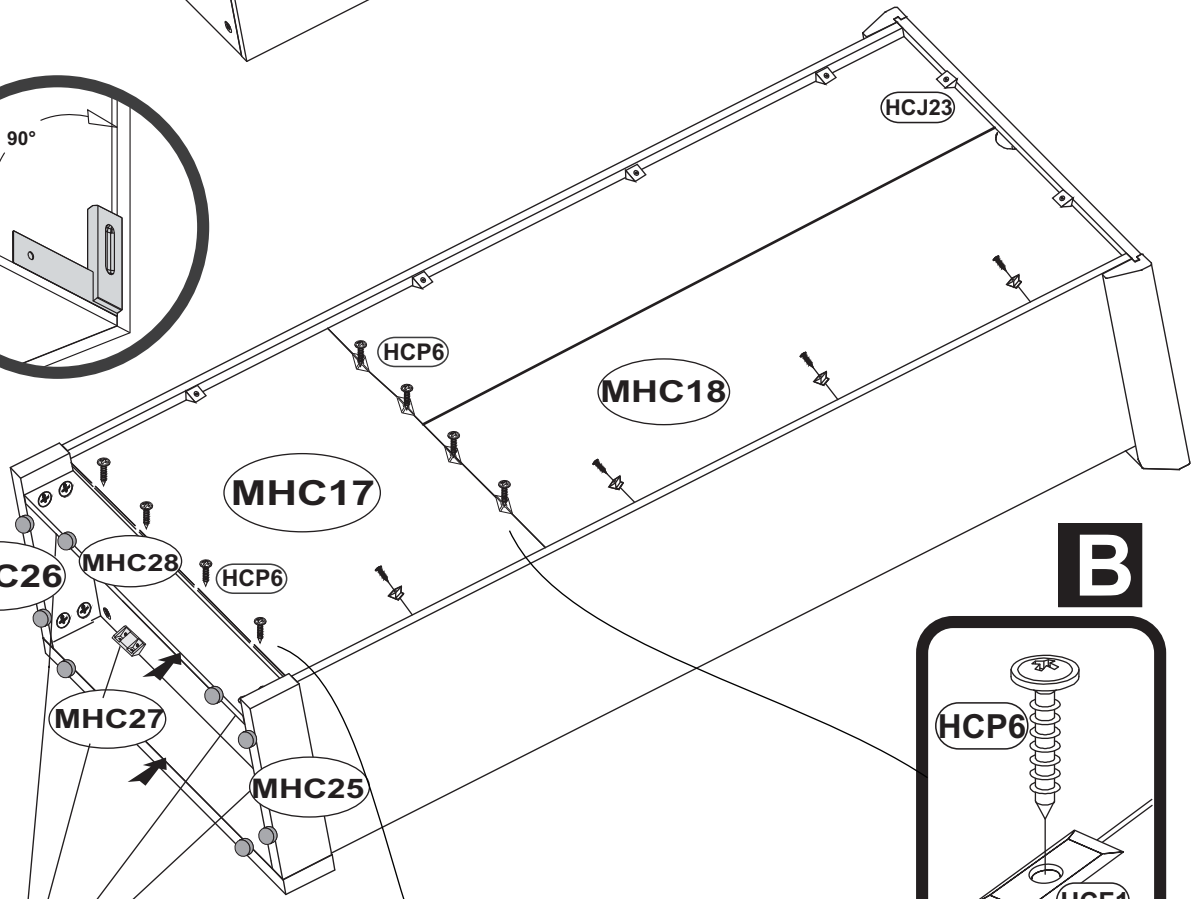
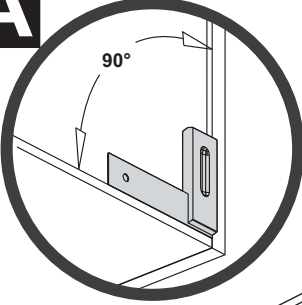

B

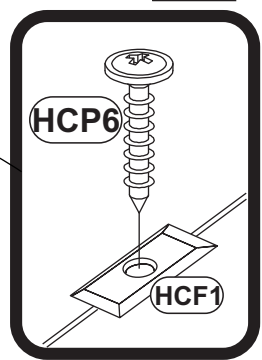

D

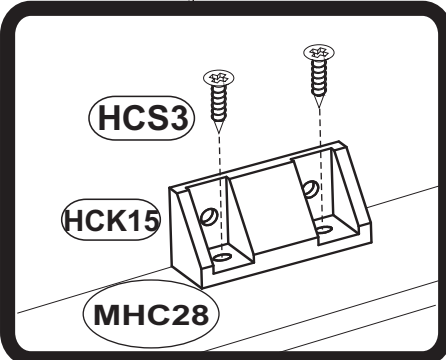

B

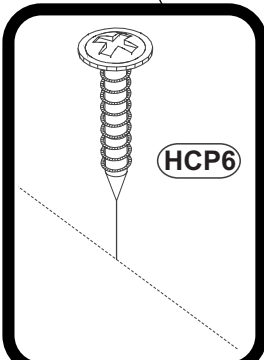



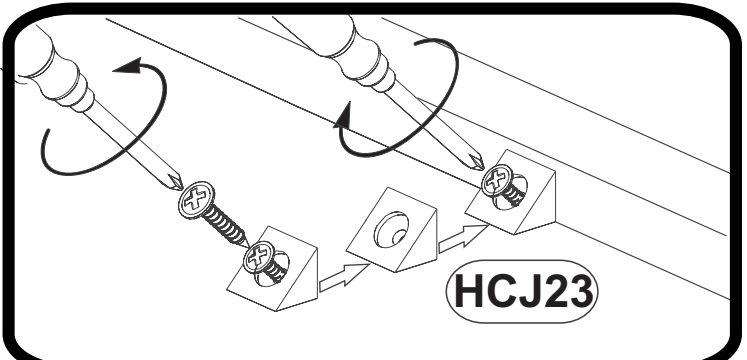

C

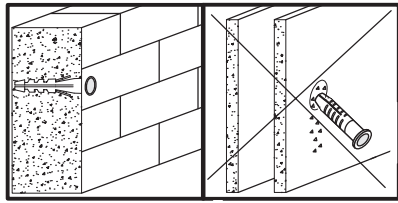
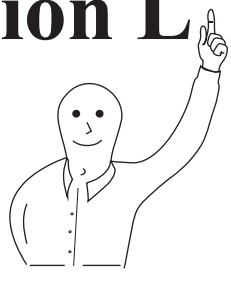

10A

Option L



HCS3 	1011
3,5x13	x20
HCW1 	1289
	x4
HCJ11 	1267
	x1

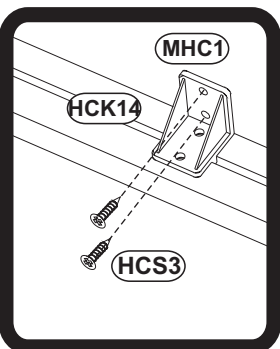
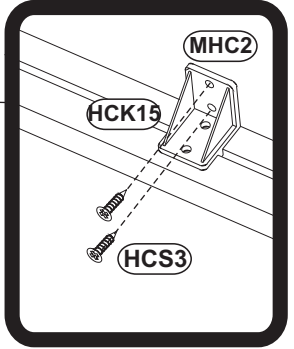
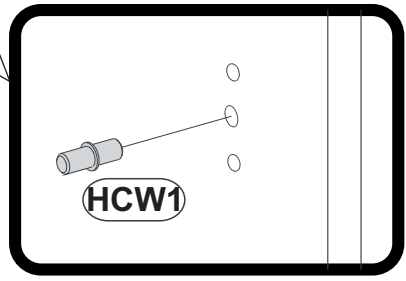
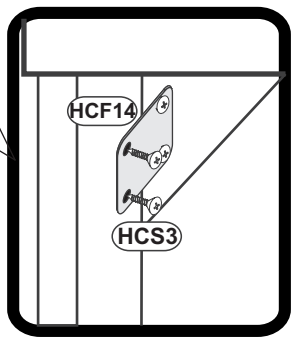
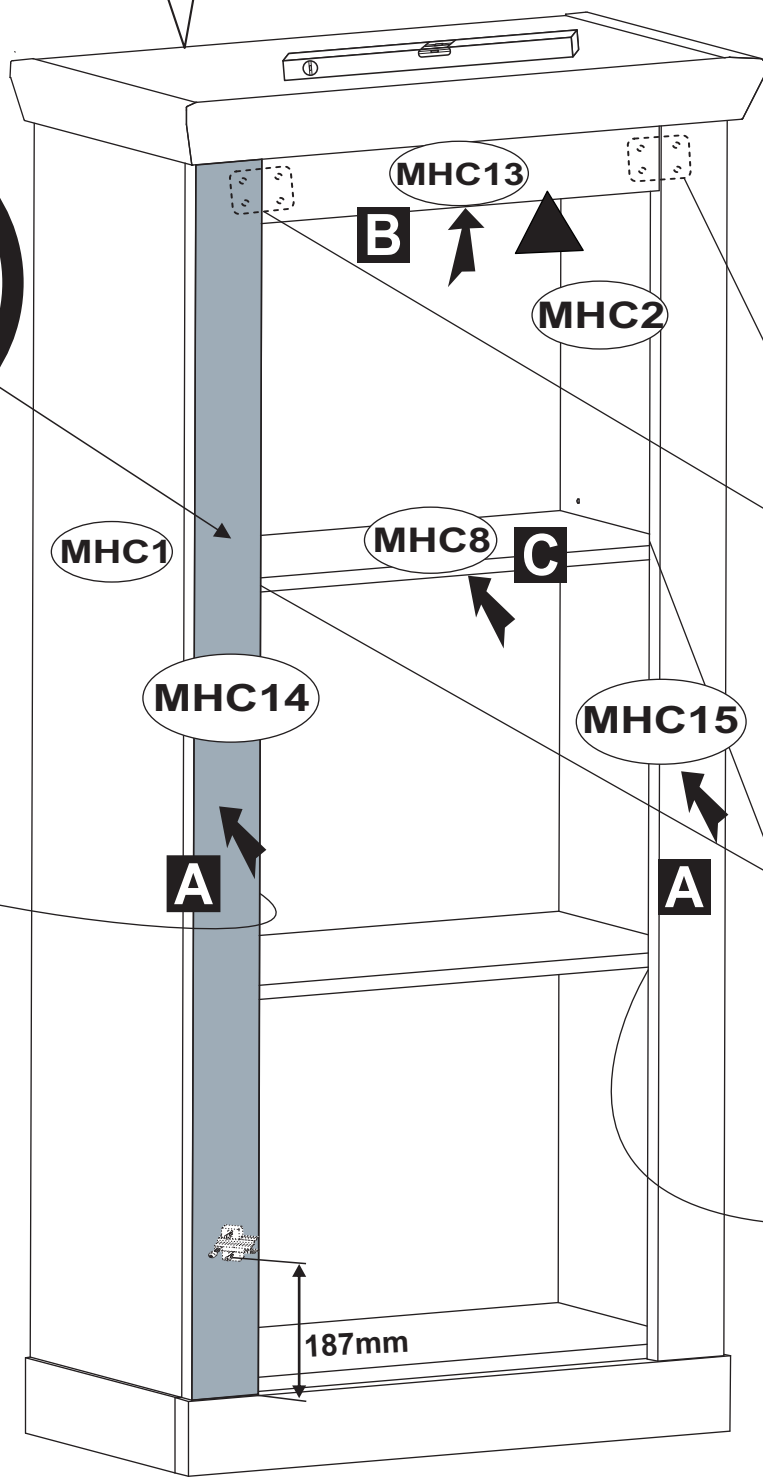
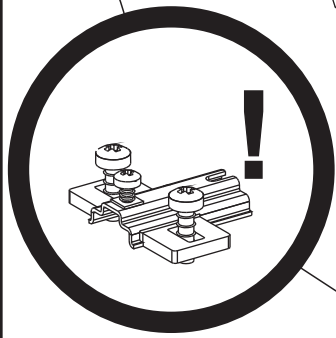
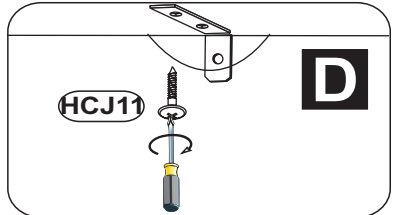
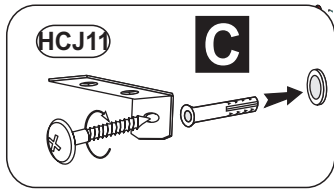
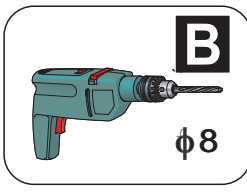
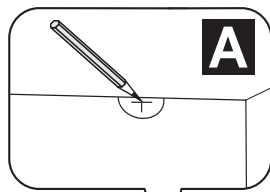
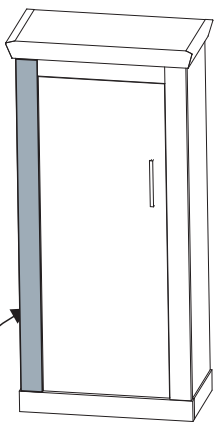

187mm

10B





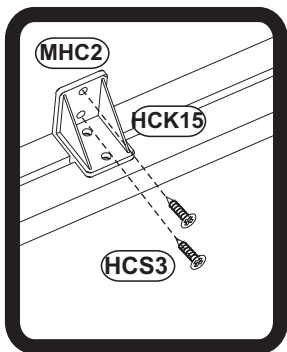
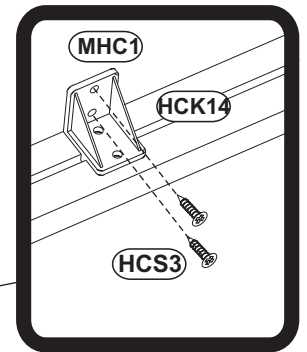
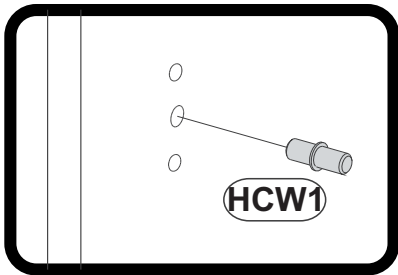
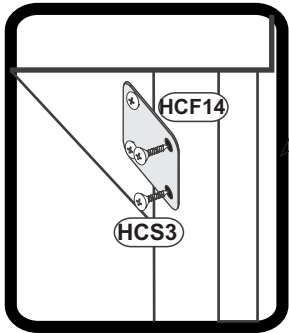
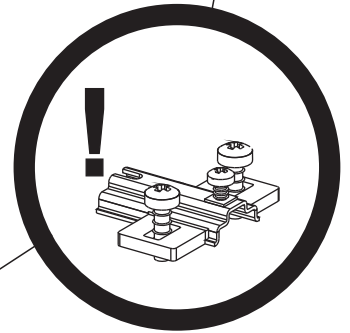
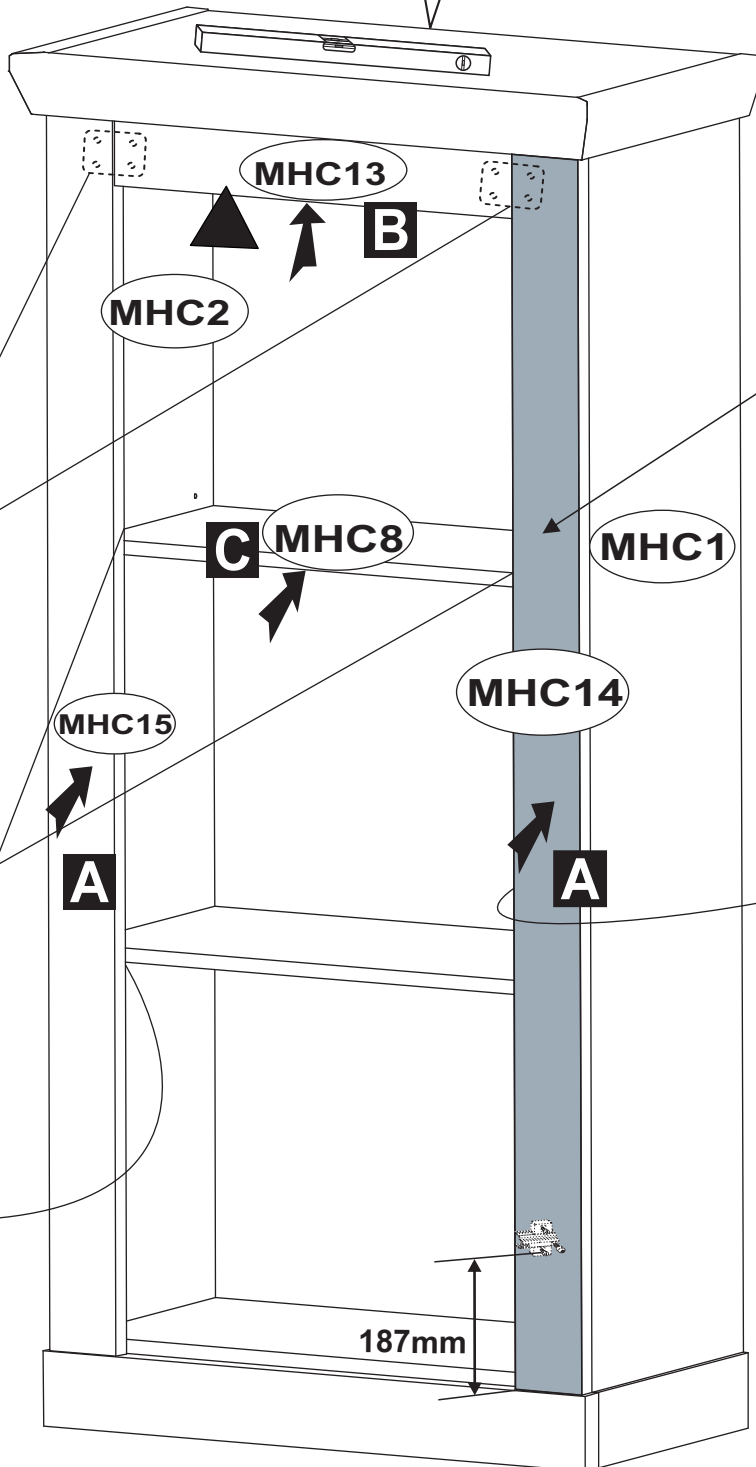
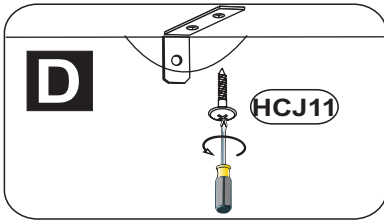
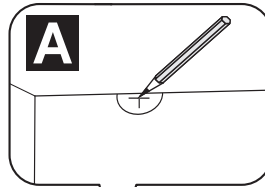
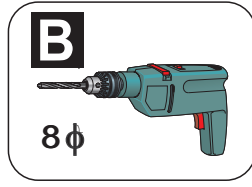
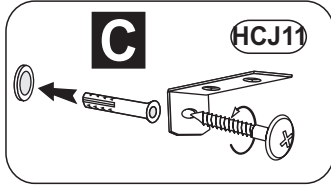
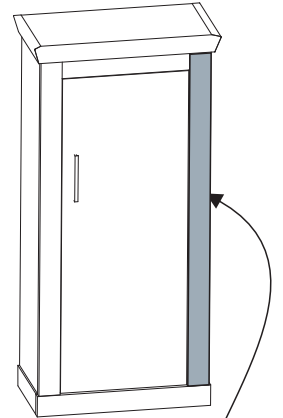
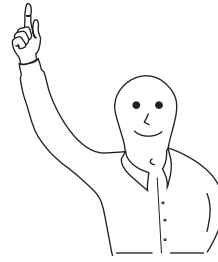
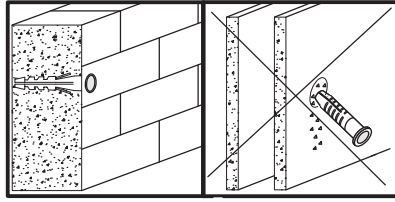

Option R

HCS3		1011
	3,5x13	x20
HCW1		1289
		x4
HCJ11		1267
		x1



11

OPTION L

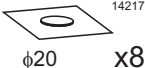
HCU4		133907	x1
HCG54		126680	x1
HCP2		1014	x1
HCA6		2549	x2
HCC6		14217	x8

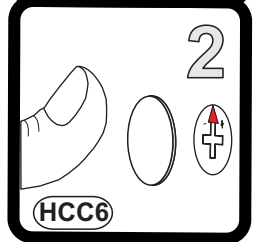
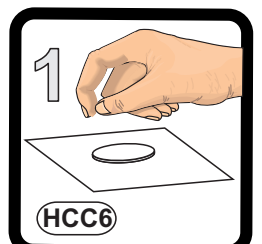
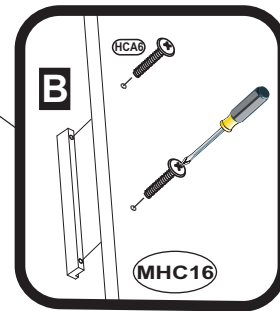
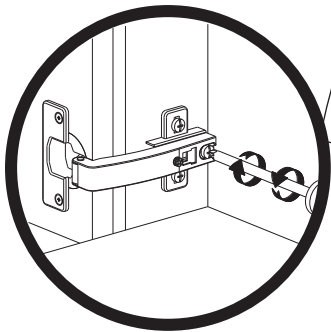
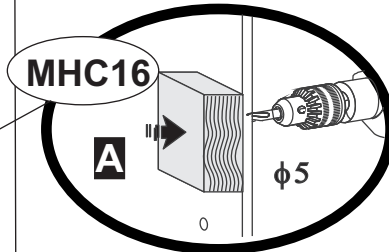
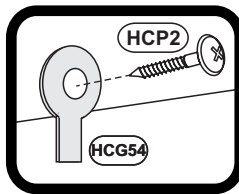
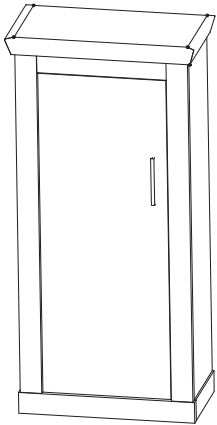

OPTION R

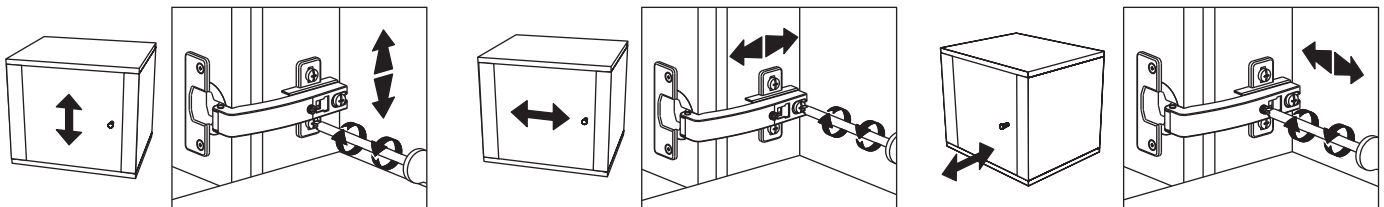
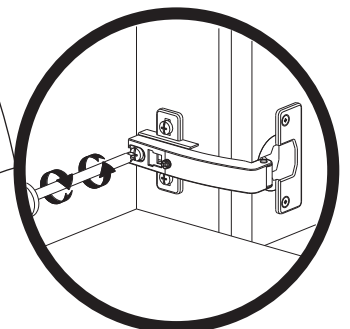
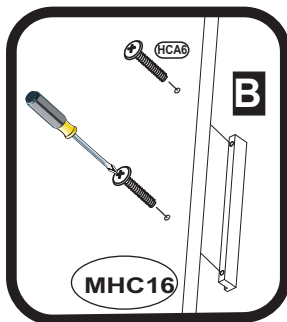
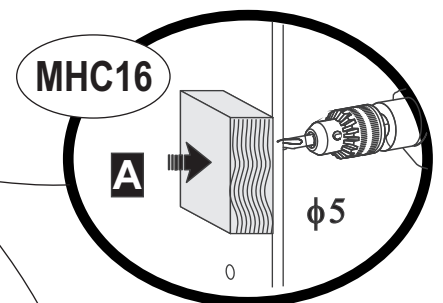
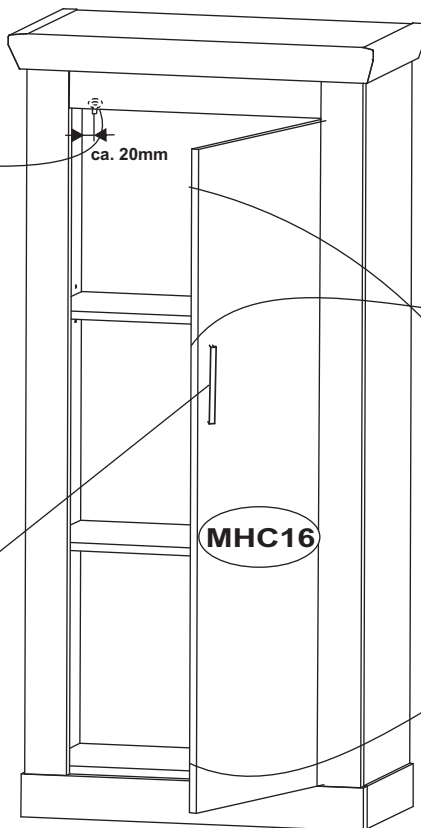
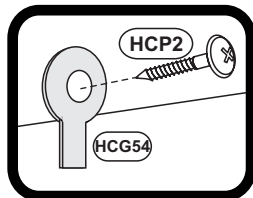
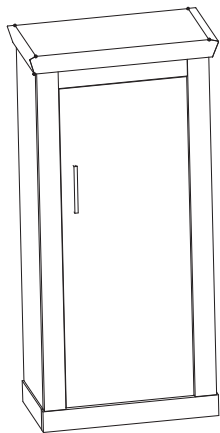

SIENA 41M

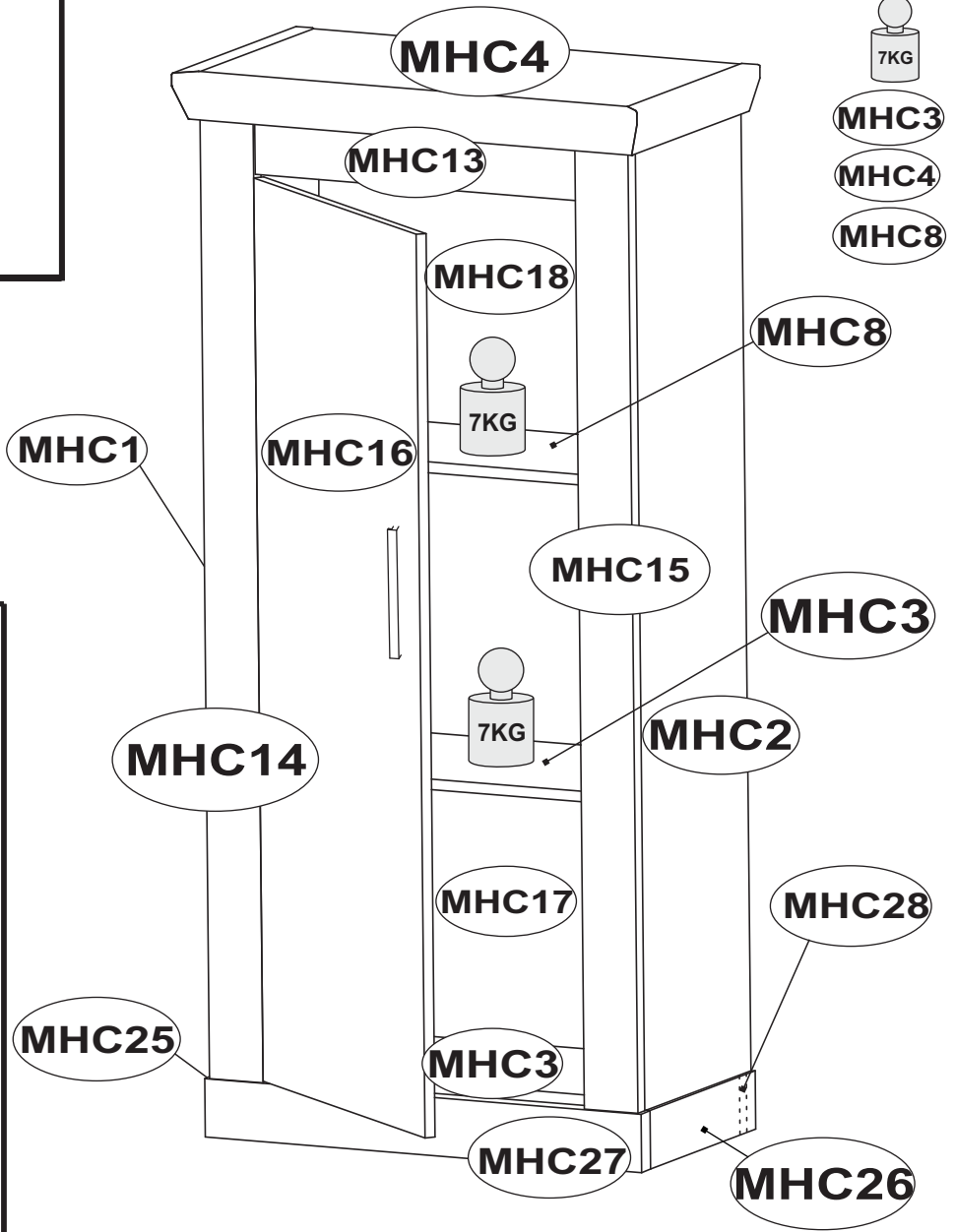
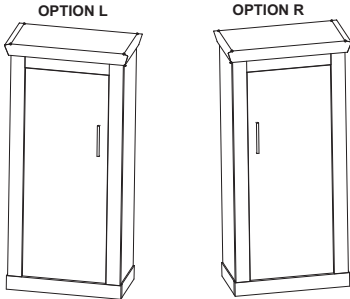

D Unser Direktservice für Beschlagteile
Sollte Ihnen ein Beschlagteil fehlen, können Sie diese Servicekarte direkt an die untenstehende Adresse mailen. Wir können allerdings nur Beschlagteile auf diesem Wege verschicken. Sollten Sie eine andere Beanstandung an Ihrem Möbelstück haben, so wenden Sie sich bitte direkt an Ihr Möbelhaus.

GB Our direct order service for fitting
If a fitting part is missing, you can e-mail this service card directly to the address below. However, we can only send fitting parts in this way. If you have any other cause for complaint concerning your item of furniture, please contact your furniture store directly.

CZ Naše přímé služby pro kování
Chybí-li vám nějaký díl z kování, můžete tuto servisní kartu odeslat e-mailem přímo na níže uvedenou adresu. Touto cestou však můžeme zoslat jen díly kování. Pokud byste reklamovali jiný díl nábytku, obraťte se přímo na svého prodejce nábytku.

F Bien étudier la notice de montage
S'il vous manque une ferrure, veuillez envoyer directement la présente carte service à l'adresse e-mail indiquée ci-dessous. Cependant, ceci nous permet uniquement d'envoyer des ferrures. Pour tout autre type de réclamation concernant votre meuble, veuillez contacter directement votre magasin d'ameublement.

I Il nostro servizio diretto per l'ordine della ferramenta
Qualora Vi dovesse mancare un pezzo di fissaggio, allora Vi preghiamo di inviare questa carta di servizio immediatamente all'indirizzo sottostante. Possiamo inviare i pezzi di fissaggio solamente per mezzo di questo procedimento. Qualora doveste avere qualche altra reclamazione in merito al mobile, allora Vi preghiamo di rivolgerVi direttamente al Vostro Negozio di mobili.

BG Нашата директна услуга за обикво
Ако липсват части от комплекта, попълнете настоящата сервисна карта и ни я изпратете на e-mail адреса, посочен по-долу. По този начин можем да доставяме само липсващи елементи от обикво. Ако установите други дефекти по мебелите, Ви съветваме да се обичете към мебелната къща/магазин, от който сте закупили стоката.

NL Onze directservice voor losse onderdelen
Wanneer er een onderdeel ontbreekt, kunt u deze servicekaart direct aan onderstaand e-mailadres sturen. Wij kunnen langs deze weg echter alleen beslagdelen versturen. Mocht u een ander probleem aan uw meubel hebben, verzoeken wij u contact op te nemen met uw meubeldealer.

PL Nasz bezpośredni serwis czesci montazowych
Jeżeli brakuje czesci koniecznych do montazu, prosimy o przeslanie nam niniejszej karty serwisowej na nizsze podany adres e-mailowy. W ten sposob mozemy przelacac Panstwu tylko brakujace czesci. W przypadku innych reklamacji dotyczacych mebla, prosimy zglosic sie do salonu meblowego, w ktorym zostal dokonany zakup.

HR Servis za okove
U slucaju da nedostaje neki od dijelova molimo vas da na dolje navedenu mail adresu posaljete ovaj servisni obrazac. Na ovaj nacin mogu se dostaviti samo okovi. U slucaju da imate dodatne prigovore vezane uz komad namjestaja molimo vas da se obratite izravno trgovini namjestaja gdje je isti kupljen.

HU Direktszoqlalatunk vasalatok esetén
Ha hiányzik egy vasalat, ezt a kártyát közvetlenül elküldheti az alább található címre. Azonban csak a vasalatoikat tudunk így küldeni. Amennyiben másfajta reklamációt áll fenn bútorárbaját illetően, forduljon közvetlenül a bútorházhoz.

SK Naše priamy servis pro častí kovania
Ak by Vám chýbala nejaká časť kovania, môžete poslať túto servisnú kartu poslať e-mailom na nižšie uvedenú adresu. Diely kovania vieme poslať iba týmto spôsobom. Ak by ste mali inú reklamáciu ohľadom Vášho nábytku, obraťte sa priamo na Vašu predajňu nábytku.

SLO Naše direktne uslužne storitve za okovje
Če vam manjka kakšno okovje, lahko to servisno kartico pošljete po e-pošti direktno na spodnji naslov. Po tej poti vam lahko pošljemo samo okovje. Če želite reklamirati kakšen drug del pohištva, se obrnite neposredno na vašo trgovino pohištva.

RO Serviciul nostru direct pentru feronerie
In cazul in care va lipsesc o piesa de feronerie puteti sa trimiteți direct acest card de service prin e-mail la adresa de mai jos. Noi nu putem expedia piese de feronerie decât pe această cale. Dacă aveți o altă reclamație referitoare la piesa de mobilier, atunci vă rugăm să vă adresați direct la magazinul dvs. de mobilier.

RUS Наш прямой сервис для поставок фурнитуры
Если окажется, что Вам не хватает того или иного элемента фурнитуры, Вы можете отправить сервисную карту по факсу непосредственно на нижеприведенный адрес электронной почты. Однако, таким образом мы можем переслать лишь фурнитуру. Если же у Вас возникнут иные претензии относительно приобретенной мебели, пожалуйста, обращайтесь непосредственно в организацию, осуществлявшую продажу.

S Vir direktservice för beslagsdelar
Om du saknar en beslagsdel kan du skicka detta servicekort direkt till e-postadressen som anges nedan. Tänk på att detta är den enda möjligheten att skicka beslagsdelar till dig. Om du vill reklamera din möbel av en annan anledning måste du kontakta ditt möbelhus direkt.

ES Nuestro servicio directo para accesorios
Si le falta algún accesorio, puede enviar esta tarjeta de servicio directamente a la siguiente dirección. No obstante, por esta método solo podemos enviar accesorios. Si tiene alguna otra objeción sobre su mueble, consulte directamente con su mueblería.

TR Donatılar için doğrudan servisimiz
Bir donatınız eksikse bu servis kartını doğrudan aşağıda bulunan adrese doğrudan mail yazabilirsiniz. Sadece bu yolla donatıları gönderilebilir. Mobilyanızda başka şikayetleriniz varsa lütfen doğrudan mobilya satıcınıza danışın.

MHC1	x1	1361	320	15	1/1
MHC2	x1	1361	320	15	1/1
MHC3	x2	611	299	15	1/1
MHC4	x1	705	373	65	1/1
MHC8	x1	610	267	15	1/1
MHC13	x1	483	124	18	1/1
MHC14	x1	1361	80	22	1/1
MHC15	x1	1361	80	22	1/1

MHC16	x1	1231	477	15	1/1
MHC17	x1	421	623	3	1/1
MHC18	x1	945	623	3	1/1
MHC25	x1	313	80	32	1/1
MHC26	x1	313	80	32	1/1
MHC27	x1	655	80	32	1/1
MHC28	x1	590	80	15	1/1

SIENA 41M

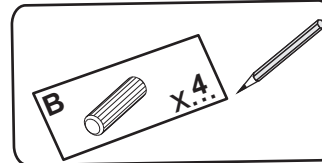
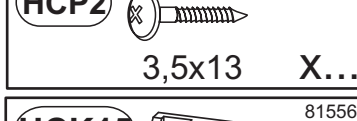
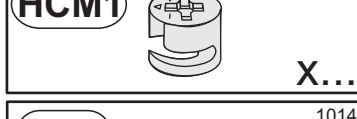
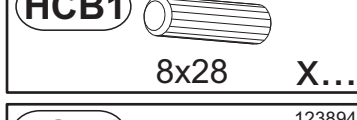
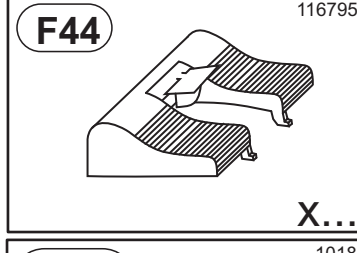
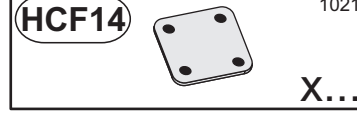
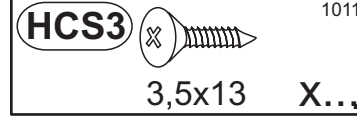
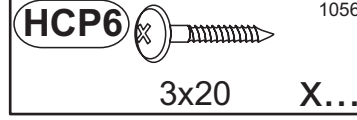
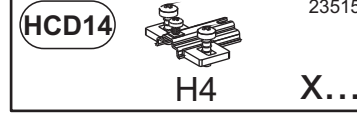
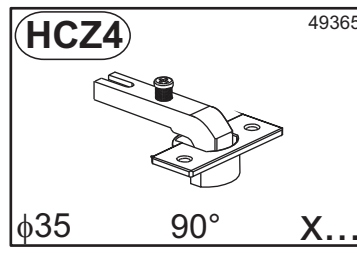
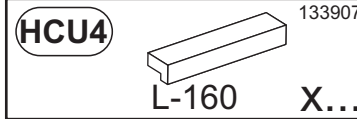
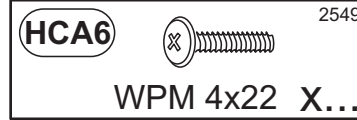
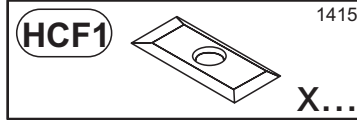
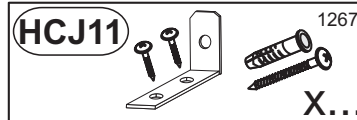
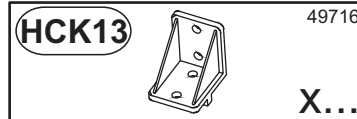
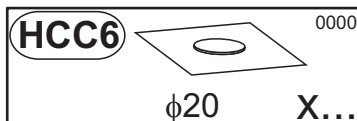
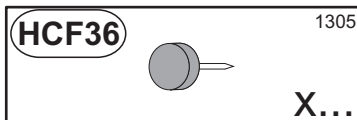
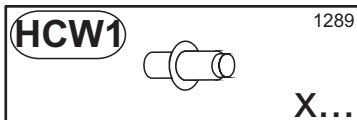
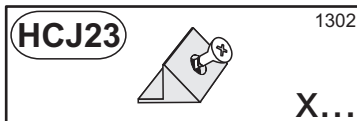
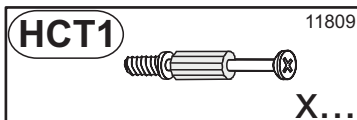

D Unser Direktservice für Beschlagteile
Sollte Ihnen ein Beschlagteil fehlen, können Sie diese Servicekarte direkt an die untenstehende Adresse mailen. Wir können allerdings nur Beschlagteile auf diesem Wege verschicken. Sollten Sie eine andere Beanstandung an Ihrem Möbelstück haben, so wenden sie sich bitte direkt an Ihr Möbelhaus.

GB Our direct order service for fitting
If a fitting part is missing, you can e-mail this service card directly to the address below. However, we can only send fitting parts in this way. If you have any other cause for complaint concerning your item of furniture, please contact your furniture store directly.

CZ Naše primé služby pro kování
Chybí-li vám nějaký díl z kování, můžete tuto servisní kartu odeslat e-mailem přímo na níže uvedenou adresu. Touto cestou však můžeme rozesílat jen díly kování. Pokud byste reklamovali jiný díl nábytku, obraťte se přímo na svého prodejce nábytku.

F Bien étudier la notice de montage
S'il vous manque une ferrure, veuillez envoyer directement la présente carte service à l'adresse e-mail indiquée ci-dessous. Cependant, ceci nous permet uniquement d'envoyer des ferrures. Pour tout autre type de réclamation concernant votre meuble, veuillez contacter directement votre magasin d'ameublement.

I Il nostro servizio diretto per l'ordine della ferramenta
Qualora Vi dovesse mancare un pezzo di fissaggio, allora Vi preghiamo di inviare questa carta di servizio immediatamente all'indirizzo sottostante. Possiamo inviare i pezzi di fissaggio solamente per mezzo di questo procedimento. Qualora dovesse avere qualche altra reclamazione in merito al mobile, allora Vi preghiamo di rivolgerVi direttamente al Vostro Negozio di mobili.

BG Нашата директна услуга за обкоя
Ако липсват части от комплекта, попълнете настоящата сервисна карта и ни я изпратете на e-mail адреса, посочен по-долу. По този начин можем да доставяме само липсващи елементи от обкоя. Ако установите други дефекти по мебелите, Ви съветваме да се обърнете към мебелната къща/магазин, от който сте закупили стоката.

NL Onze directservice voor losse onderdelen
Wanneer er een onderdeel ontbreekt, kunt u deze servicekaart direct aan onderstaand e-mailadres sturen. Wij kunnen alleen de weg echter alleen beslagdelen versturen. Mocht u een ander probleem aan uw meubel hebben, verzoeken wij u contact op te nemen met uw meubeldealer.

PL Nasz bezpośredni serwis części montażowych
Jeżeli brakuje części koniecznych do montażu, prosimy o przesłanie nam niniejszej karty serwisowej na niżej podany adres e-mailowy. W ten sposób możemy przesyłać Państwu tylko brakujące części. W przypadku innych reklamacji dotyczących mebla, prosimy zgłosić się do salonu meblowego, w którym został dokonany zakup.

HR Servis za okove
U slučaju da nedostaje neki od dijelova molimo vas da na dolje navedenu mail adresu pošaljete ovaj servisni obrazac. Na ovaj način mogu se dostaviti samo okovi. U slučaju da imate dodatne prigovore vezane uz komad namještaja molimo vas da se obratite izravno trgovini namještaja gdje je isti kupljen.

HU Direktszolgáltatunk vasalatok esetén
Ha hiányzik egy vasalattól, ezt a kártyát közvetlenül elküldheti az alább található címre. Azonban csak vasalattokat tudunk így küldeni. Amennyiben másfajta reklamáció áll fenn bútorárbaját illetően, forduljon közvetlenül a bútorházához.

SK Naš priamy servis pre časti kovania
Ak by Vám chýbala nejaká časť kovania, môžete poslať túto servisnú kartu poslať e-mailom na nižšie uvedenú adresu. Diely kovania vieme poslať iba týmto spôsobom. Ak by ste mali inú reklamáciu ohľadom Vášho nábytku, obráťte sa priamo na Vašu predajňu nábytku.

SLO Naše direktne uslužbne storitve za okovje
Ce vam manjka kakšno okovje, lahko to servisno kartico pošljete po e-pošti direktno na spodnji naslov. Po tej poti vam lahko pošljemo samo okovje. Ce želite reklamirati kakšen drug del pohištva, se obrnite neposredno na vašo trgovino pohištva.

RO Service-ul nostru direct pentru feronerie
In cazul in care va lipseste o piesa de feronerie puteti sa trimiteți direct acest card de service prin e-mail la adresa de mai jos. Noi nu putem expedia piese de feronerie decât pe această cale. Dacă aveți o altă reclamație referitoare la piesa de mobilier, atunci vă rugăm să vă adresați direct la magazinul dvs. de mobilă.

RUS Наш прямой сервис для поставок фурнитуры
Если окажется, что Вам не хватает того или иного элемента фурнитуры, Вы можете отправить сервисную карту по факсу непосредственно на нижеприведенный адрес электронной почты. Однако, таким образом мы можем пересылать лишь фурнитуру. Если же у Вас возникнут иные претензии относительно приобретенной мебели, пожалуйста, обращайтесь непосредственно в организацию, осуществившую продажу.

S Vir direktservice för beslagsdelar
Om du saknar en beslagsdel kan du skicka detta servicekort direkt till e-postadressen som anges nedan. Tänk på att detta är den enda möjligheten att skicka beslagsdelar till dig. Om du vill reklamera din möbel av en annan anledning måste du kontakta ditt möbelför direkt.

ES Nuestro servicio directo para accesorios
Si le falta algún accesorio, puede enviar esta tarjeta de servicio directamente a la siguiente dirección. No obstante, por este método solo podemos enviar accesorios. Si tiene alguna otra objeción sobre su mueble, consulte directamente con su mueblería.

TR Donatılar için doğrudan servisimiz
Bir donatınız eksikse bu servis kartını doğrudan aşığada bulunan adrese doğrudan mail yazabilirsiniz. Sadece bu yolla donatıları gönderebilirsiniz. Mobilyanızda başka şikayetleriniz varsa lütfen doğrudan mobilya satıcınıza danışın.

SIENA 71M

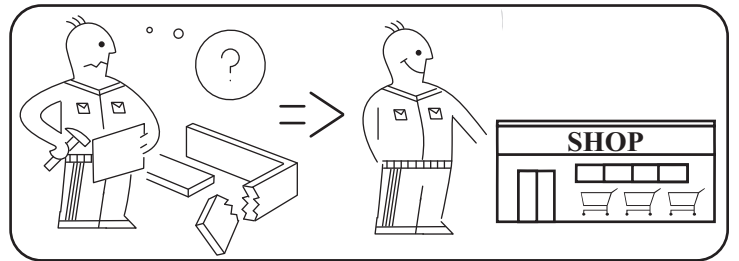
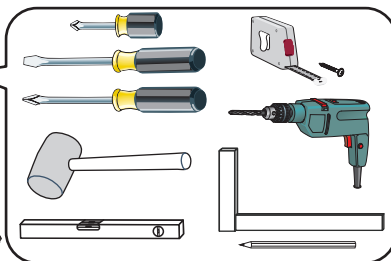
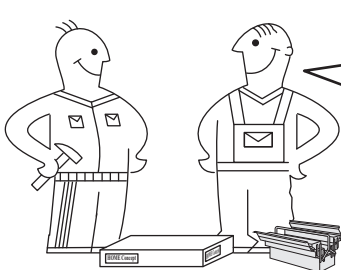
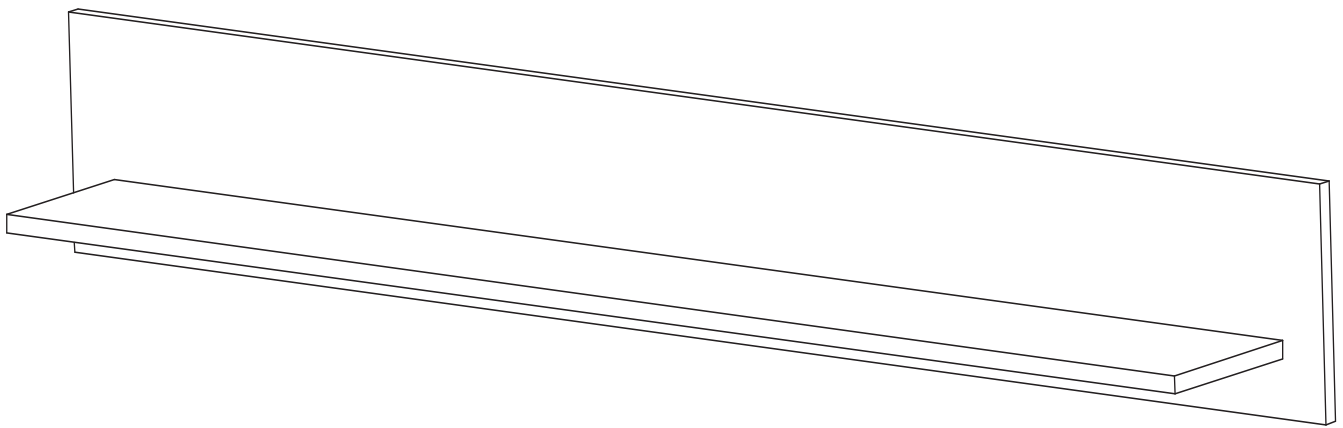
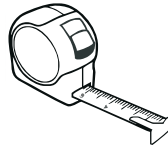

SIENA 71M

max.



MHC2

MHC2

max.



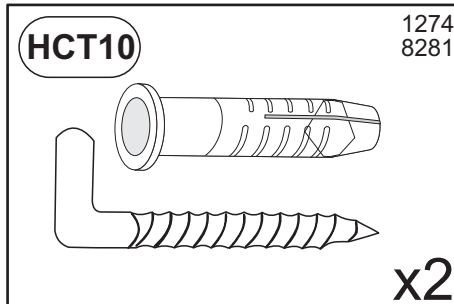
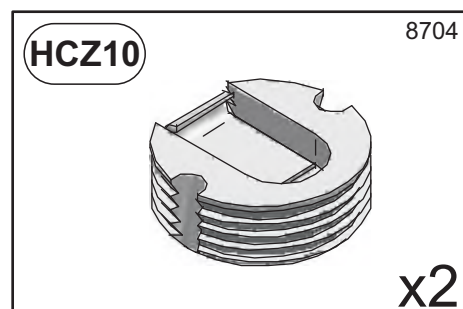
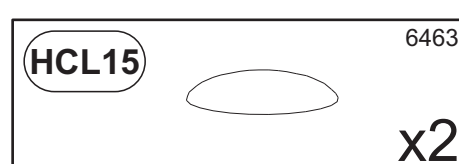
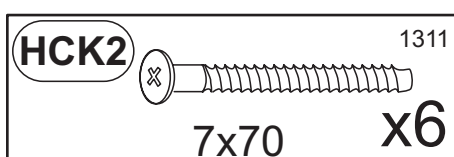
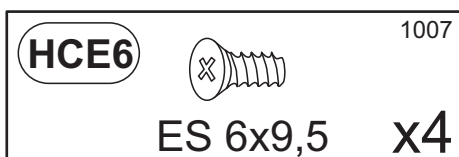

MHC1

MHC1	x1	1500	200	15	1/1
MHC2	x1	1400	169	15	1/1



1

HCZ10		8704
		x2
HCE6		1007
	ES 6x9,5	x4

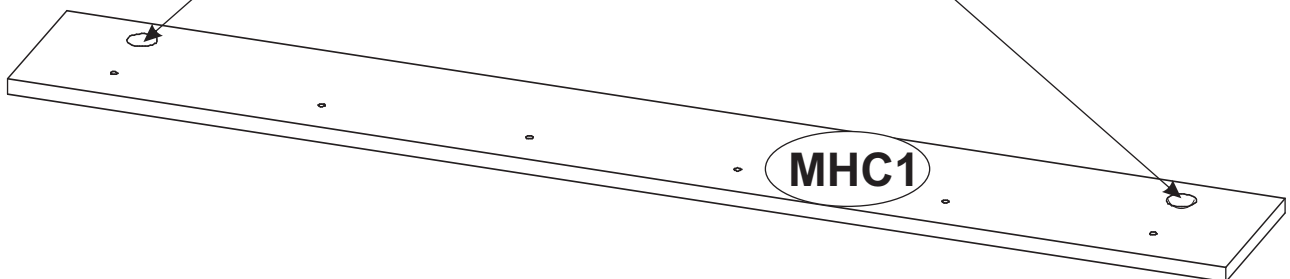
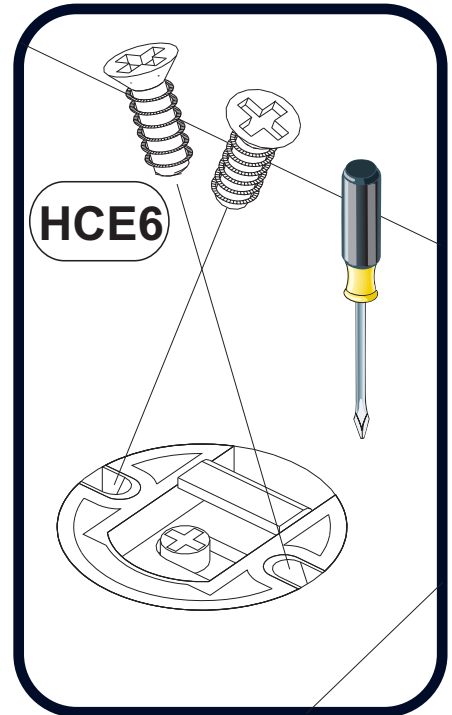
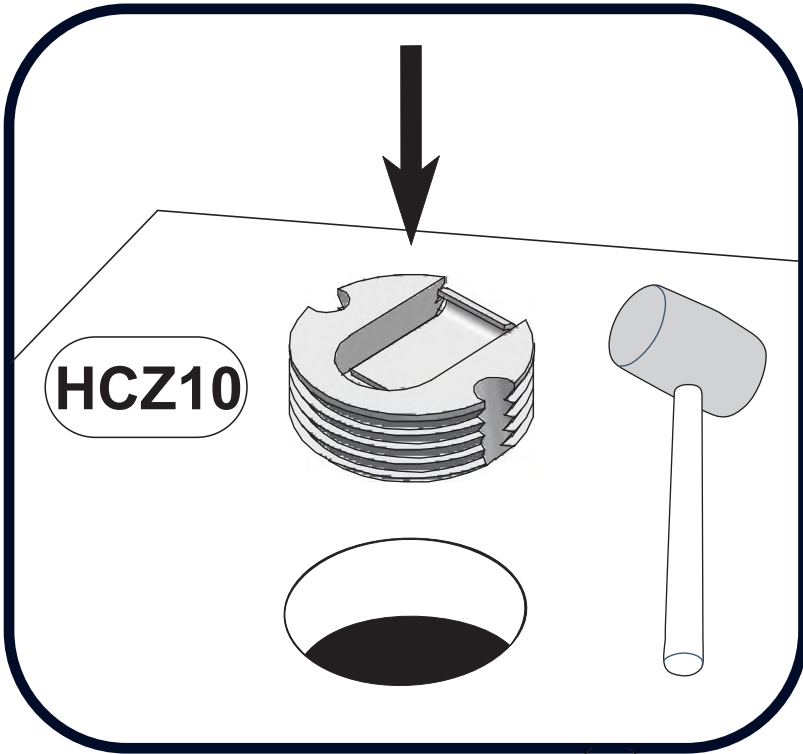

2

HCK2 7x70 x6

HCL15 6463 x2

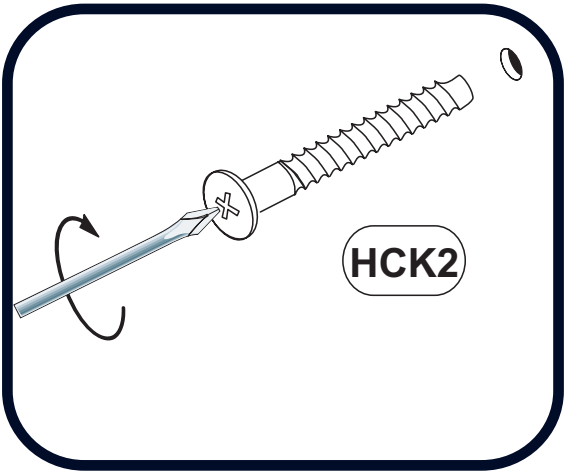
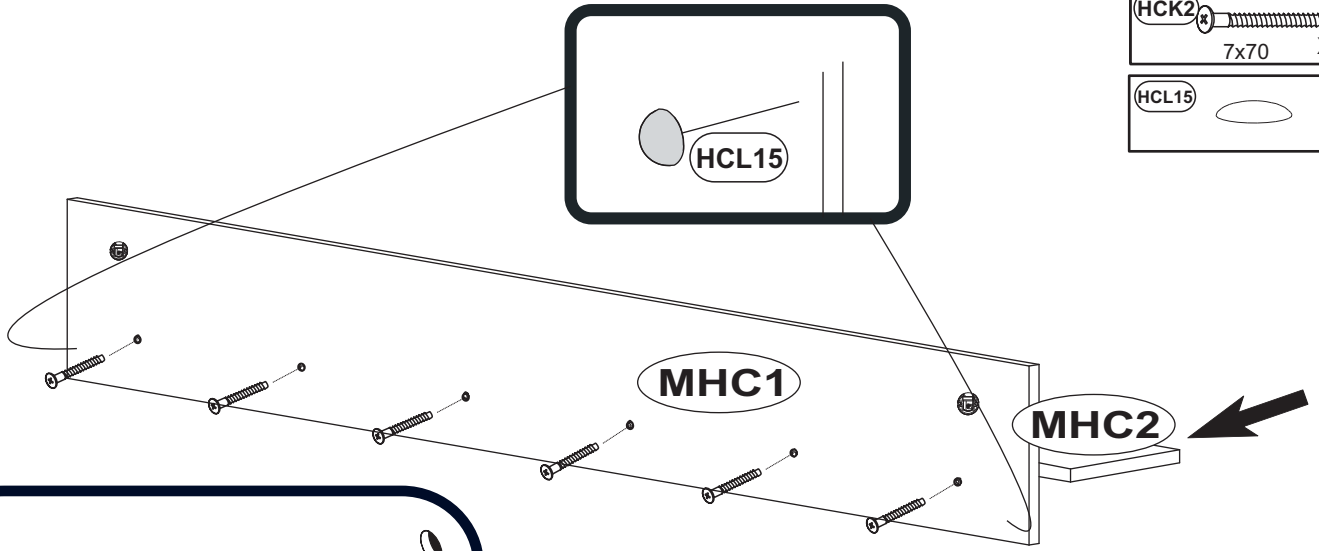

3

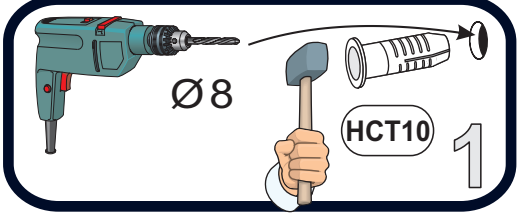

HCT10 1274 8281 x2

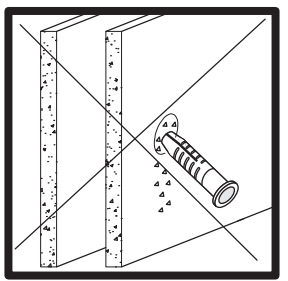
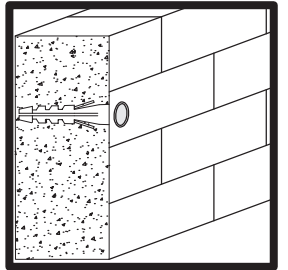
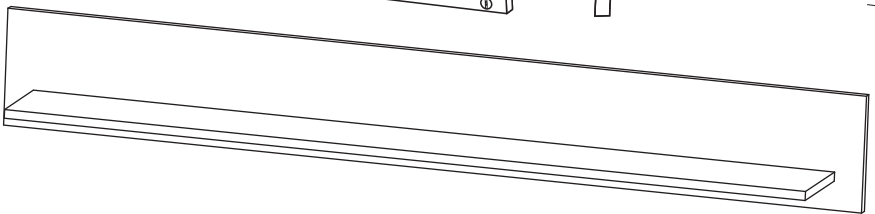
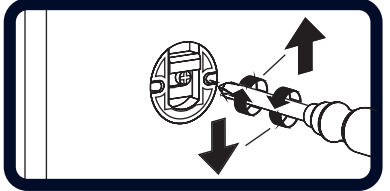
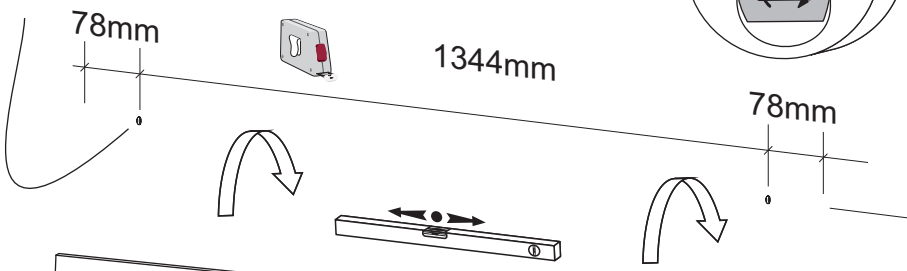

SIENA 71M

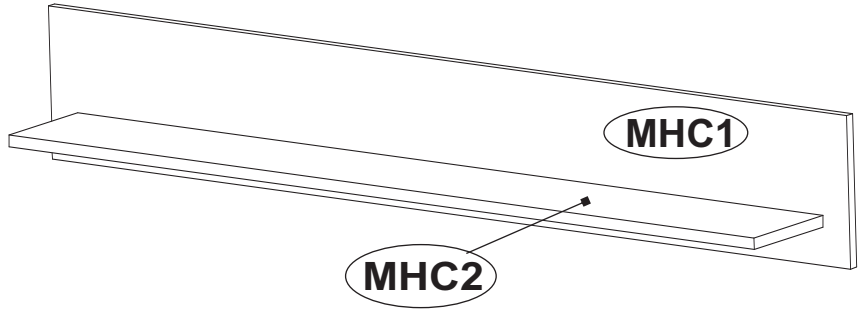

Unser Direktservice für Beschlagteile

D Sollte Ihnen ein Beschlagteil fehlen, können Sie diese Servicekarte direkt an die untenstehende Adresse mailen. Wir können allerdings nur Beschlagteile auf diesem Wege verschicken. Sollten Sie eine andere Beanstandung an Ihrem Möbelstück haben, so wenden Sie sich bitte direkt an Ihr Möbelhaus.

Our direct order service for fitting

GB If a fitting part is missing, you can e-mail this service card directly to the address below. However, we can only send fitting parts in this way. If you have any other cause for complaint concerning your item of furniture, please contact your furniture store directly.

Naše primé služby pro kování

CZ Chybí-li vám nějaký díl z kování, můžete tuto servisní kartu odeslat e-mailem přímo na níže uvedenou adresu. Touto cestou však můžeme zoslat jen díly kování. Pokud byste reklamovali jiný díl nábytku, obraťte se přímo na svého prodejce nábytku.

Bien étudier la notice de montage

F Si vous manque une ferrure, veuillez envoyer directement la présente carte service à l'adresse e-mail indiquée ci-dessous. Cependant, ceci nous permet uniquement d'envoyer des ferrures. Pour tout autre type de réclamation concernant votre meuble, veuillez contacter directement votre magasin d'ameublement.

Il nostro servizio diretto per l'ordine della ferramenta

I Qualora Vi dovesse mancare un pezzo di fissaggio, allora Vi preghiamo di inviare questa carta di servizio immediatamente all'indirizzo sottostante. Possiamo inviare i pezzi di fissaggio solamente per mezzo di questo procedimento. Qualora dovesse avere qualche altra reclamazione in merito al mobile, allora Vi preghiamo di rivolgerVi direttamente al Vostro Negozio di mobili.

Нашата директна услуга за обков

BG Ако липсват части от комплекта, попълнете настоящата сервисна карта и ни я изпратете на e-mail адреса, посочен по-долу. По този начин можем да доставяме само липсващи елементи от обкова. Ако установите други дефекти по мебелите, Ви съветваме да се обърнете към мебелната къща/магазин, от който сте закупили стоката.

Onze directservice voor losse onderdelen

NL Wanneer er een onderdeel ontbreekt, kunt u deze servicekaart direct aan onderstaand e-mailadres sturen. Wij kunnen langs deze weg echter alleen beslagdelen versturen. Mocht u een ander probleem aan uw meubel hebben, verzoeken wij u contact op te nemen met uw meubeldealer.

Nasz bezpośredni serwis części montażowych

PL Jeżeli brakuje części koniecznych do montażu, prosimy o przesłanie nam niniejszej karty serwisowej na niżej podany adres e-mailowy. W ten sposób możemy przesać Państwu tylko brakujące części. W przypadku innych reklamacji dotyczących mebla, prosimy zgłosić się do salonu meblowego, w którym został dokonany zakup.

Servis za okove

HR U slučaju da nedostaje neki od dijelova molimo vas da na dolje navedenu mail adresu pošaljete ovaj servisni obrazac. Na ovaj način mogu se dostaviti samo okovi. U slučaju da imate dodatne prigovore vezane uz komad namještaja molimo vas da se obratite izravno trgovini namještaja gdje je isti kupljen.

Direktszolgáltatunk vasalatok esetén

HU Ha hiányzik egy vasalat, ezt a kártyát közvetlenül elküldheti az alább található címre. Azonban csak vasalatokat tudunk így küldeni. Amennyiben másfajta reklamáció áll fenn bútordarabját illetően, forduljon közvetlenül a bútortházhoz.

Náš priamy servis pre časti kovania

SK Ak by Vám chýbala nejaká časť kovania, môžete poslať túto servisnú kartu poslať e-mailom na nižšie uvedenú adresu. Diely kovania vieme poslať iba týmto spôsobom. Ak by ste mali inú reklamáciu ohtľadom Vášho nábytku, obráťte sa priamo na Vašu predajňu nábytku.

Naše direktne uslužne storitve za okovje

SLO Če vam manjka kakšno okovje, lahko to servisno kartico pošljete po e-pošti direktno na spodnji naslov. Po tej poti vam lahko pošljemo samo okovje. Če želite reklamirati kakšen drug del pohištva, se obrnite neposredno na vašo trgovino pohištva.

Servicio-ul nostru direct pentru feronerie

RO În cazul în care vă lipsește o piesă de feronerie puteți să trimiteți direct acest card de service prin e-mail la adresa de mai jos. Noi nu putem expedia piese de feronerie decât pe această cale. Dacă aveți o altă reclamație referitoare la piesa de mobilier, atunci vă rugăm să vă adresați direct la magazinul dvs. de mobilă.

Наш прямой сервис для поставок фурнитуры

RUS Если окажется, что Вам не хватает того или иного элемента фурнитуры, Вы можете отправить сервисную карту по факсу непосредственно на нижеприведенный адрес электронной почты. Однако, таким образом мы можем переслать лишь фурнитуру. Если же у Вас возникнут иные претензии относительно приобретенной мебели, пожалуйста, обращайтесь непосредственно в организацию, осуществившую продажу.

Vir direktservice för beslagsdelar

S Om du saknar en beslagsdel kan du skicka detta servicekort direkt till e-postadressen som anges nedan. Tank på att detta är den enda möjligheten att skicka beslagsdelar till dig. Om du vill reklamera din möbel av en annan anledning måste du kontakta ditt möbelfhus direkt.

Nuestro servicio directo para accesorios

ES Si le falta algún accesorio, puede enviar esta tarjeta de servicio directamente a la siguiente dirección. No obstante, por este método solo podemos enviar accesorios. Si tiene alguna otra objeción sobre su mueble, consulte directamente con su mueblería.

Donatilar için doğrudan servisimiz

TR Bir donatınız eksikse bu servis kartını doğrudan aşağıda bulunan adrese doğrudan mail yazabilirsiniz. Sadece bu yolla donatılar gönderiliriz. Mobilyanızda başka şikayetleriniz varsa lütfen doğrudan mobilya satıcınıza danışın.

MHC1	x1	1500	200	15	1/1
MHC2	x1	1400	169	15	1/1

SIENA 71M

Unser Direktservice für Beschlagteile

Sollte Ihnen ein Beschlagteil fehlen, können Sie diese Servicekarte direkt an die untenstehende Adresse mailen. Wir können allerdings nur Beschlagteile auf diesem Wege verschicken. Sollten Sie eine andere Beanstandung an Ihrem Möbelstück haben, so wenden sie sich bitte direkt an Ihr Möbelhaus.

Our direct order service for fitting

If a fitting part is missing, you can e-mail this service card directly to the address below. However, we can only send fitting parts in this way. If you have any other cause for complaint concerning your item of furniture, please contact your furniture store directly.

Naše přímé služby pro kování

Chybí-li vám nějaký díl z kování, můžete tuto servisní kartu odeslat e-mailem přímo na níže uvedenou adresu. Touto cestou však můžeme rozesílat jen díly kování. Pokud byste reklamovali jiný díl nábytku, obraťte se přímo na svého prodejce nábytku.

Bien étudier la notice de montage

S'il vous manque une ferrure, veuillez envoyer directement la présente carte service à l'adresse e-mail indiquée ci-dessous. Cependant, ceci nous permet uniquement d'envoyer des ferrures. Pour tout autre type de réclamation concernant votre meuble, veuillez contacter directement votre magasin d'ameublement.

Il nostro servizio diretto per l'ordine della ferramenta

Qualora Vi dovesse mancare un pezzo di fissaggio, allora Vi preghiamo di inviare questa carta di servizio immediatamente all'indirizzo sottostante. Possiamo inviare i pezzi di fissaggio solamente per mezzo di questo procedimento. Qualora doveste avere qualche altra reclamazione in merito al mobile, allora Vi preghiamo di rivolgerVi direttamente al Vostro Negozio di mobili.

Нашата директна услуга за обкоя

Ако липсват части от комплекта, попълнете настоящата сервисна карта и ни я изпратете на e-mail адреса, посочен по-долу. По този начин можем да доставяме само липсващи елементи от обкоя. Ако установите други дефекти по мебелите, Ви съветваме да се обвърнете към мебелната къща/магазин, от който сте закупили стоката.

Onze directservice voor losse onderdelen

Wanneer er een onderdeel ontbreekt, kunt u deze servicekaart direct aan onderstaand e-mailadres sturen. Wij kunnen langs deze weg echter alleen beslagdelen versturen. Mocht u een ander probleem aan uw meubel hebben, verzoeken wij u contact op te nemen met uw meubeldealer.

Nasz bezpośredni serwis czeski montazowych

Jeżeli brakuje części koniecznych do montażu, prosimy o przesłanie nam niniejszej karty serwisowej na niżej podany adres e-mailowy. W ten sposób możemy przesyłać Państwu tylko brakujące części. W przypadku innych reklamacji dotyczących mebla, prosimy zgłosić się do salonu meblowego, w którym został dokonany zakup.

Servis za okove

U slučaju da nedostaje neki od dijelova molimo vas da na dolje navedenu mail adresu pošaljete ovaj servisni obrazac. Na ovaj način mogu se dostaviti samo okovi. U slučaju da imate dodatne prigovore vezane uz komad namještaja molimo vas da se obratite izravno trgovini namještaja gdje je isti kupljen.

Direktszolóalatlunk vasalatok esetén

Ha hiányzik egy vasalat, ezt a kártyát közvetlenül elküldheti az alább található címre. Azonban csak is vasalatoskat tudunk így küldeni. Amennyiben másfajta reklamáció áll fenn bútorárbaját illetően, forduljon közvetlenül a bútorházhoz.

Náš priamy servis pre časti kovania

Ak by Vám chýbala nejaká časť kovania, môžete poslať túto servisnú kartu poslať e-mailom na nižšie uvedenú adresu. Diely kovania vieme poslať iba týmto spôsobom. Ak by ste mali inú reklamáciu ohľadom Vášho nábytku, obráťte sa priamo na Vašu predajňu nábytku.

Naše direktne uslužne storitve za okovje

Ce vam manjka kakšno okovje, lahko to servisno kartico pošljete po e-pošti direktno na spodnji naslov. Po tej poti vam lahko pošljemo samo okovje. Če želite reklamirati kakšen drug del pohištva, se obrnite neposredno na vašo trgovino pohištva.

Service-ul nostru direct pentru feronerie

În cazul în care vă lipsește o piesă de feronerie puteți să trimiteți direct această card de service prin e-mail la adresa de mai jos. Noi nu putem expedia piese de feronerie decât pe această cale. Dacă aveți o altă reclamație referitoare la piesa de mobilier, atunci vă rugăm să vă adresați direct la magazinul dvs. de mobilă.

Наш прямой сервис для поставок фурнитуры

Если окажется, что Вам не хватает того или иного элемента фурнитуры, Вы можете отправить сервисную карту по факсу непосредственно на нижеприведенный адрес электронной почты. Однако, таким образом мы можем пересылать лишь фурнитуру. Если же у Вас возникли иные претензии относительно приобретенной мебели, пожалуйста, обращайтесь непосредственно в организацию, осуществившую продажу.

Vir direktservice för beslagsdelar

Om du saknar en beslagsdel kan du skicka detta servicekort direkt till e-postadressen som anges nedan. Tänk på att detta är den enda möjligheten att skicka beslagsdelar till dig. Om du vill reklamera din möbel av en annan anledning måste du kontakta ditt möbelhus direkt.

Nuestro servicio directo para accesorios

Si le falta algún accesorio, puede enviar esta tarjeta de servicio directamente a la siguiente dirección. No obstante, por este método solo podemos enviar accesorios. Si tiene alguna otra objeción sobre su mueble, consulte directamente con su mueblería.

Donatilar için doğrudan servisimiz

Bir donatınız eksikse bu servis kartını doğrudan aşağıda bulunan adrese doğrudan mail yazabilirsiniz. Sadece bu yolla donatılar gönderiliriz. Mobilyanızda başka şikayetleriniz varsa lütfen doğrudan mobilya satıcınıza danışın.

HCZ10

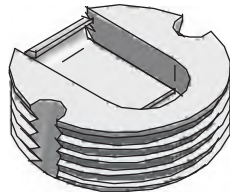

8704

X...

HCL15



6463

X...

HCK2



7x70

X...

1311

HCT10

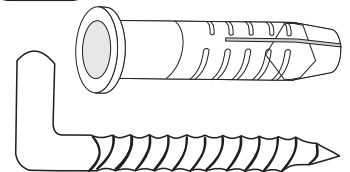

1274
8281

X...

HCE6



ES 6x9,5

X...

1007

