

# Carolina SKL 100\*200



- |                                       |   |
|---------------------------------------|---|
| <b>D</b> Montageanleitung             | <b>GB</b> Assembly instructions         |
| <b>NL</b> Handleiding voor de montage | <b>PL</b> Instrukcja montazu            |
| <b>TR</b> Montaj talimati             | <b>RU</b> Инструкция по монтажу         |
| <b>RO</b> Instructiunile de instalare | <b>I</b> Istruzioni per l'installazione |
| <b>F</b> Instructions d'installation  | <b>SK</b> Pokyny k inštalácii           |
| <b>CZ</b> Pokyny k instalaci          | <b>H</b> Telepítési utasítások          |

Dokument-Nr:

16019522

Ausgabe:

20120104

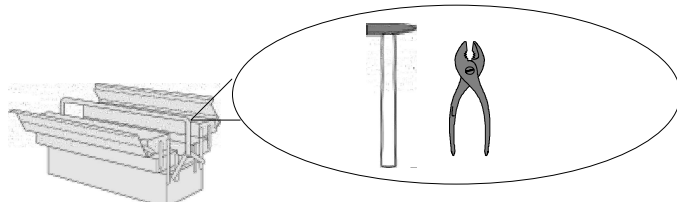
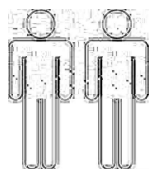

**Service • Dienstverlening • Serwis • Servis • Сервисная служба**

Name • Naam • Nazwa • İsim • Название  
**Carolina SKL**

Nr. • No. • Номер  
**16019522**

Typ • Type • Тип • Тип  
**Polsterbett 100 x200**

 **schwarz/weiß/beige**

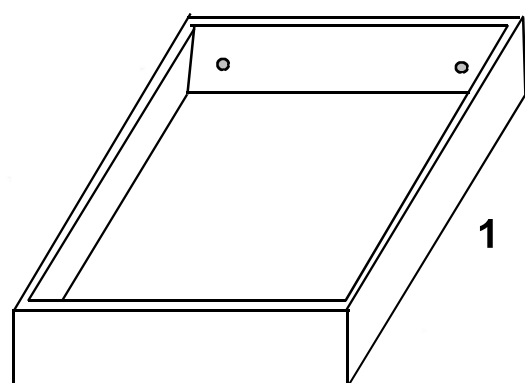
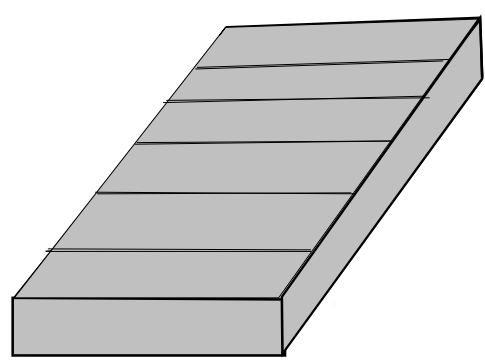
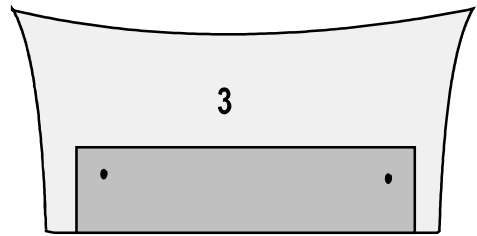
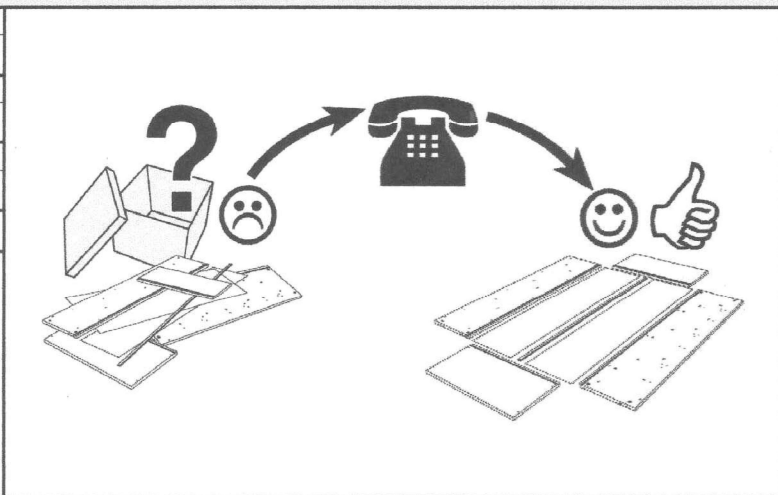
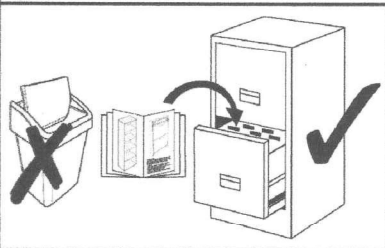

**2**

**1**

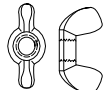
<b>A</b>		<b>2X</b>	<b>B</b>		<b>2X</b>
<b>SCHLOSSSCHRAUBE</b>			<b>FLÜGELMUTTER</b>		
<b>M 8 X 60</b>			<b>M 8</b>		

