

Montageanleitung

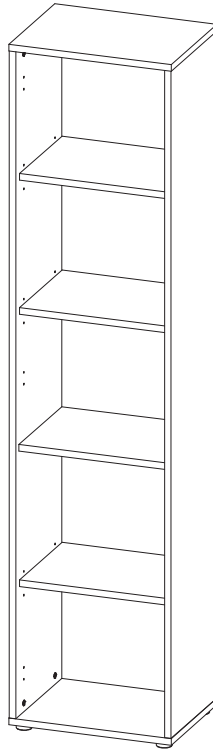

Sehr geehrte Kundin, sehr geehrter Kunde,
wir gratulieren Ihnen zum Erwerb Ihres neuen Möbelstückes.
Trotz größter Sorgfalt kann es aber vorkommen, dass in einem
Beschlagbeutel oder an einem Fertigungsteil ein Mangel ist.
Sollte dies bei Ihrem Möbelstück der Fall sein, kennzeichnen
Sie dieses deutlich auf der Skizze und geben Sie bitte die
fehlende Stückzahl an.

Für evtl. auftretende Rückfragen zum Artikel oder zur Montage
senden Sie uns bitte eine E-Mail:

support@bmg-moebel.de





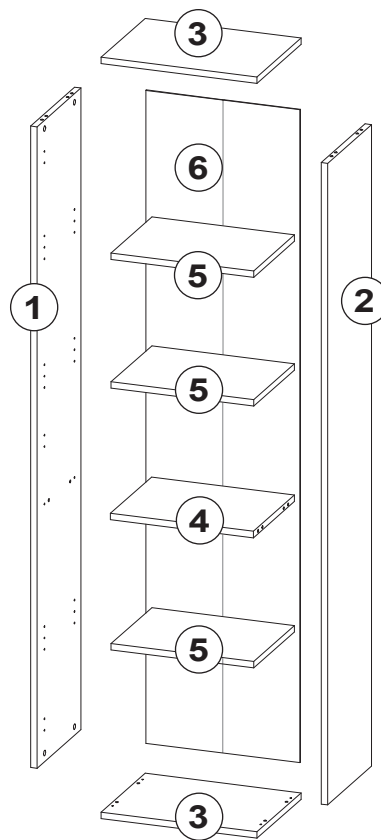
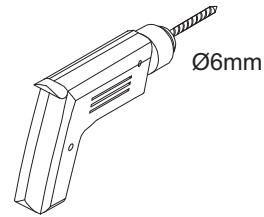
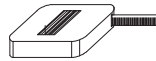
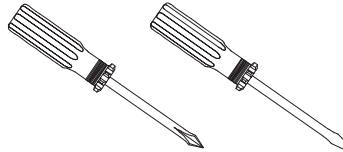
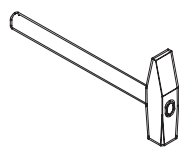
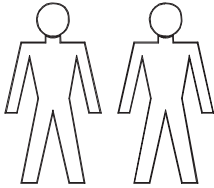

Bitte lesen Sie diese Montageanleitung gut durch, da wir für
Fehler, die durch falsche Montage entstehen keine Haftung
übernehmen!

Office

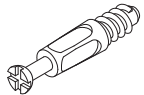
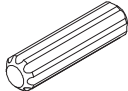
Regal hoch - schmal

Für die Montage dieser Type benötigen Sie:

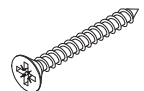

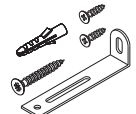
 AA 12 Stück Excenter	 BD 12 Stück Spannbolzen
 DA 12 Stück Holzdübel 30mm	 C 12 Stück Bodenträger
 H 50 Stück Nagel	 FU 4 Stück Gleitfuß
 SB 4 Stück Schraube 4,0x30	 AK 12 Stück Abdeckkappe
 ZA 1 Stück Befestigungssatz	

Name

.....

Straße

.....

PLZ, Ort

.....

Telefon für Rückfragen

.....

E-Mail für Rückfragen

.....

Gekauft bei

.....

Datum

.....

1

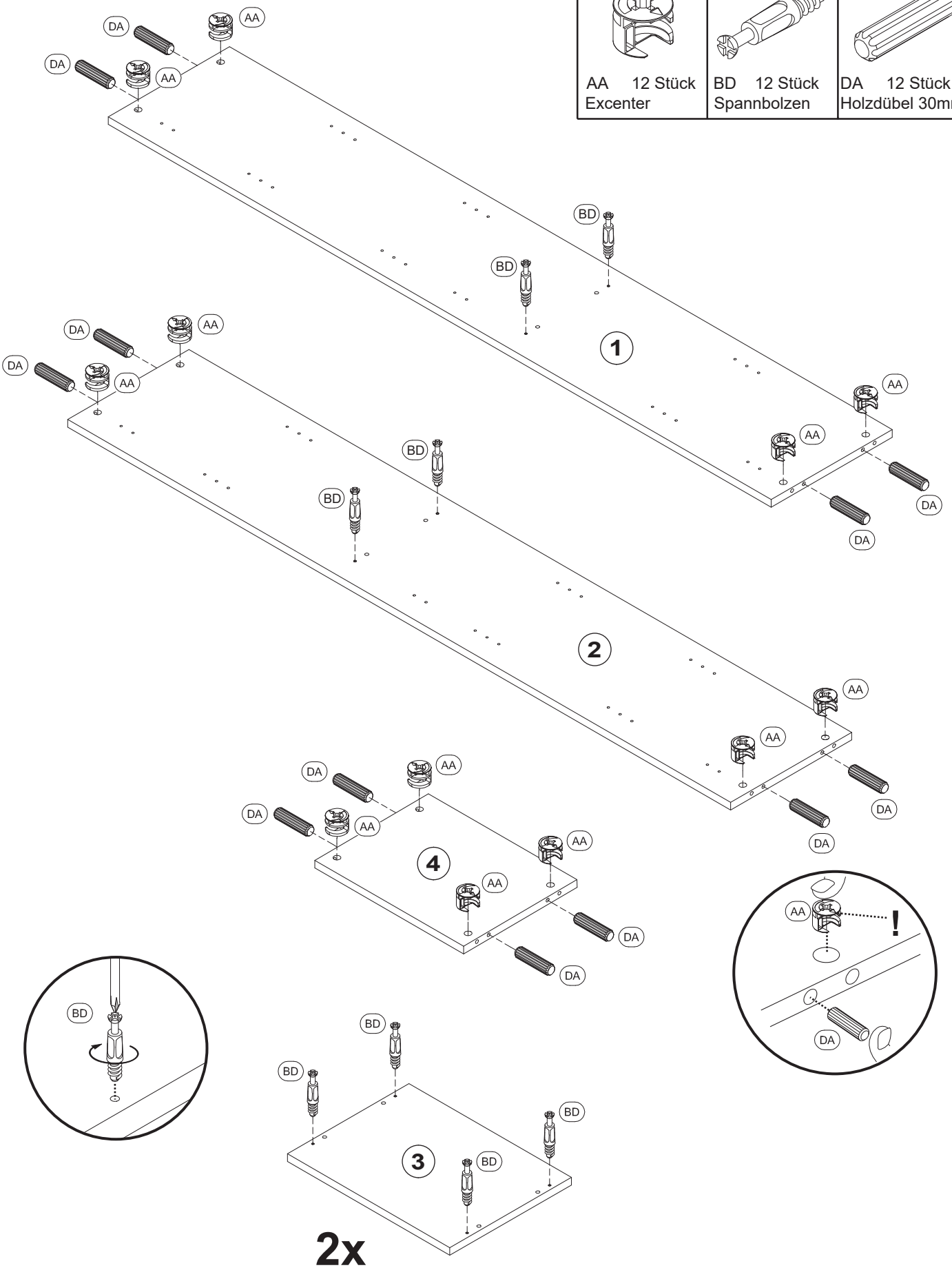

2

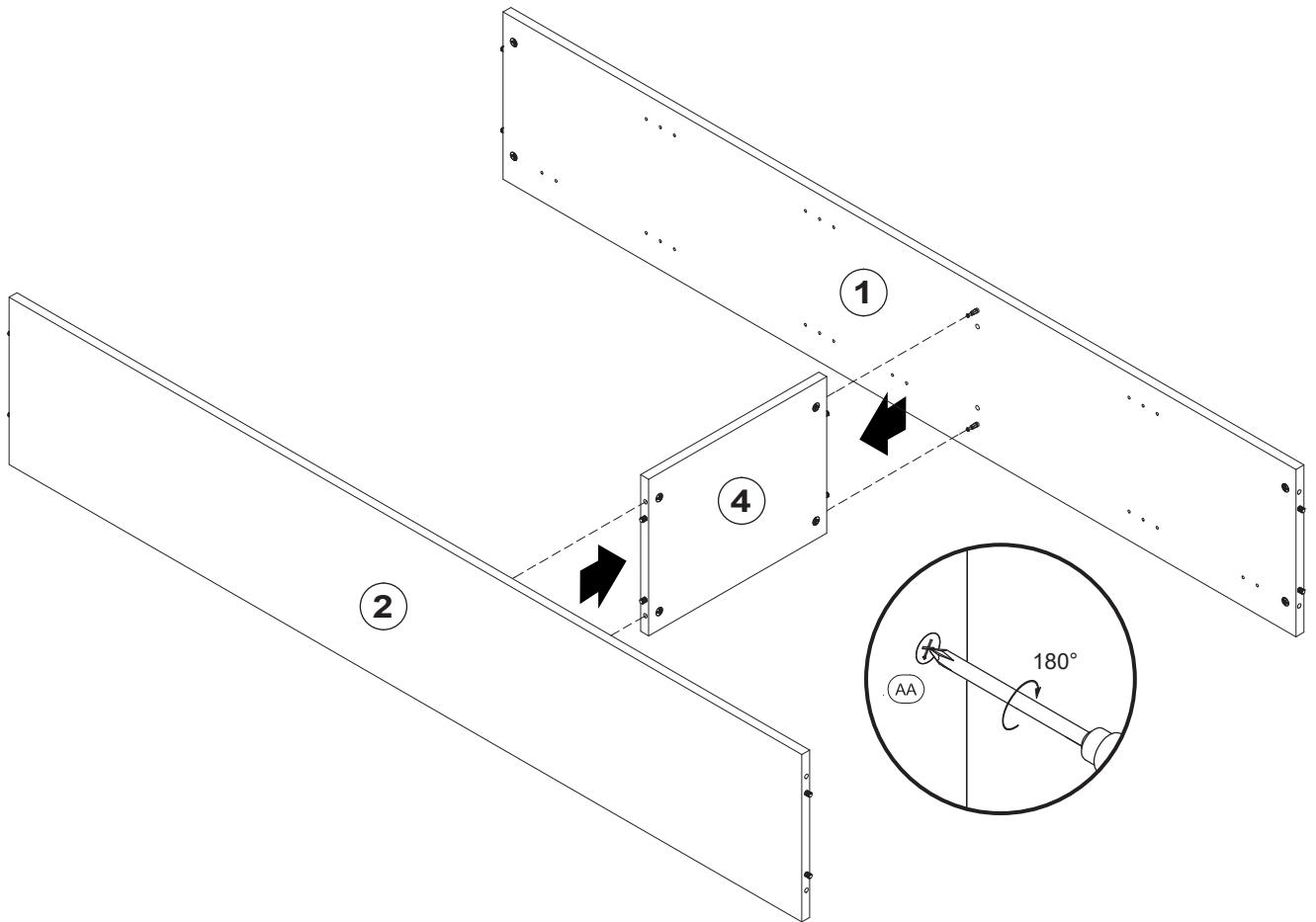

3

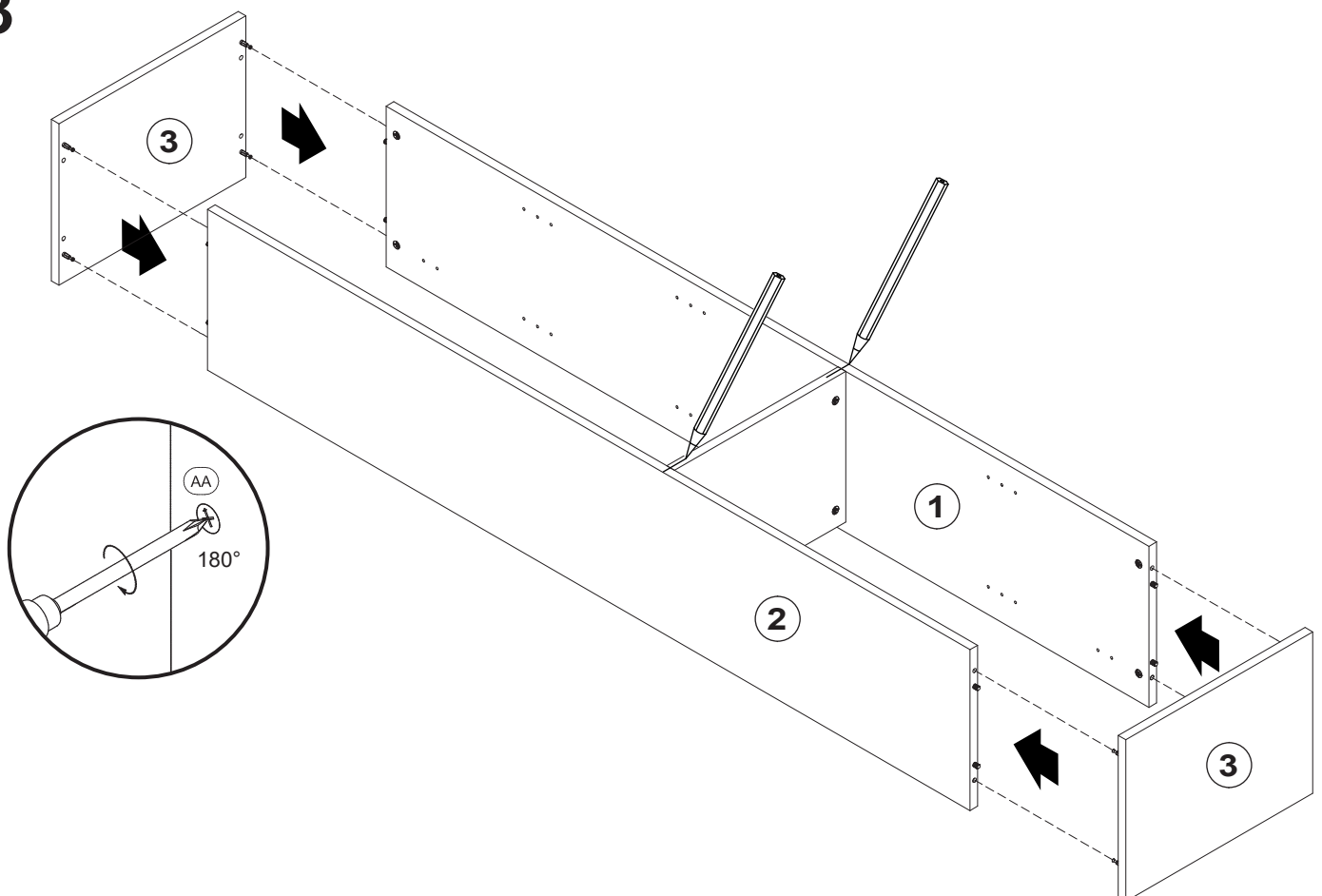

4

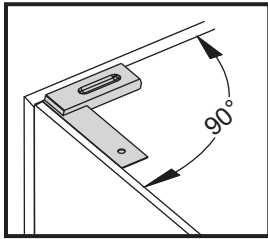

H 50 Stück Nagel	FU 4 Stück Gleitfuss	SB 4 Stück Schraube 4,0x30

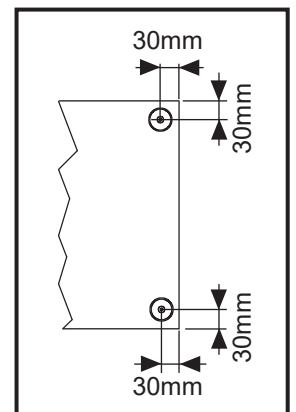
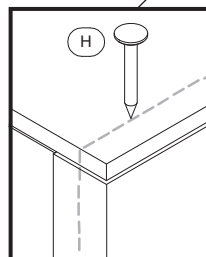
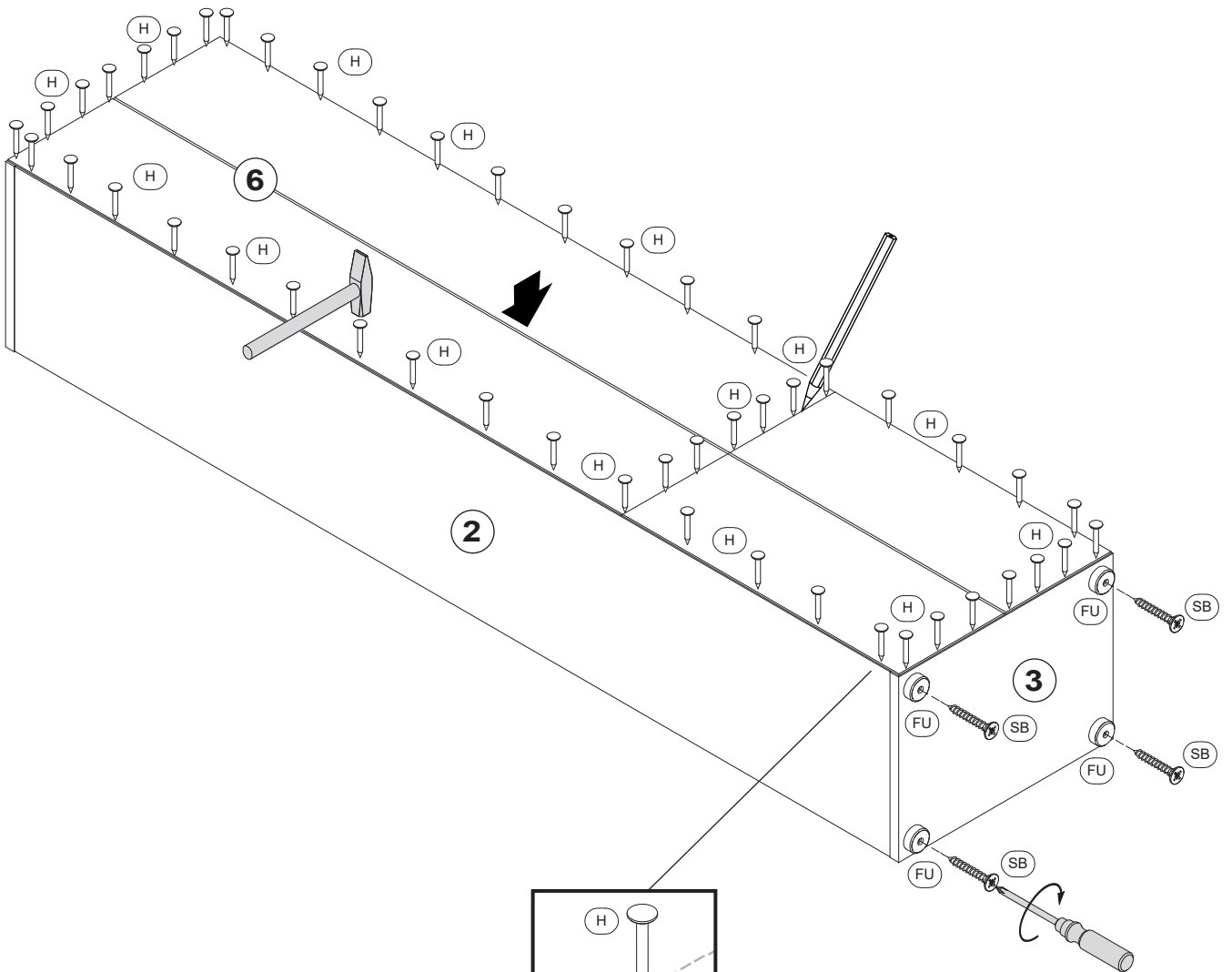

Office

Regal hoch - schmal

5



Achtung!
Wandbefestigung
zwingend erforderlich.

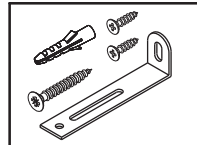

ZA 1 Stück
Befestigungssatz

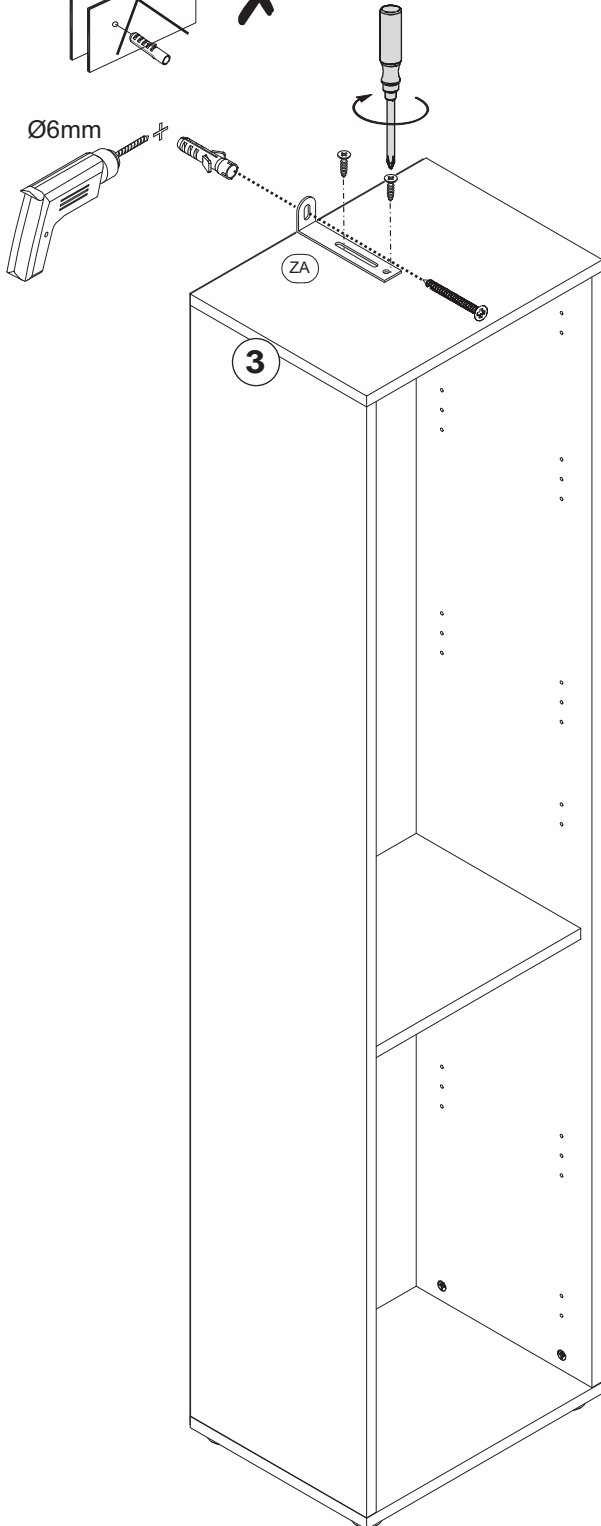
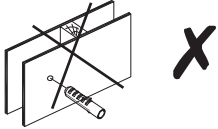
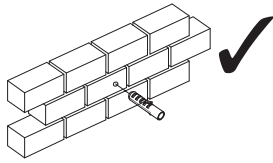

6

