

FACKELMANN®

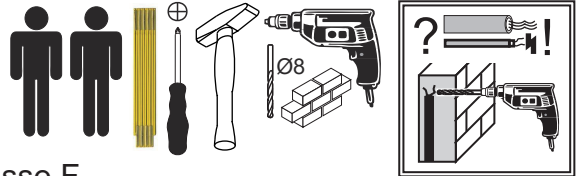

Dieses Produkt enthält Lichtquellen der Energieeffizienzklasse F.
This product contains light sources of energy efficiency class F.

mirrors
by **FACKELMANN®**

Breite	Artikelnr.	X (Maß)
400 mm	84512 84532	Seite 2 Page 2
600 mm	84513 84533	
800 mm	84514 84534	
1000 mm	84515 84535	

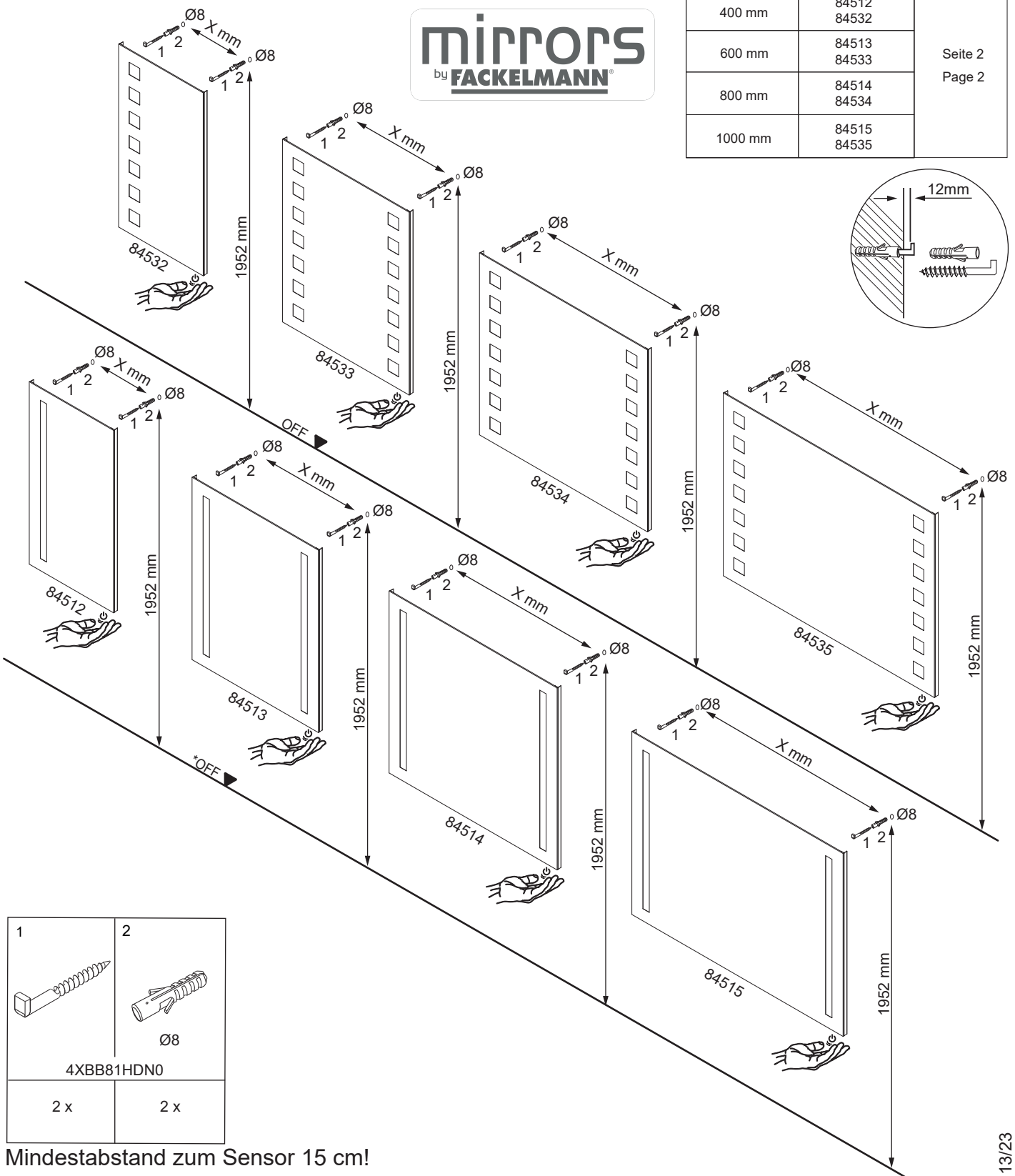

1	2
Ø8	
4XBB81HDN0	
2 x	2 x

Mindestabstand zum Sensor 15 cm!

The minimum distance to the sensor switch is 15 cm!

*OFF = Oberkante fertiger Fußboden

*OFF = Top edge of finished floor

Alle Maßangaben sind ca.-Maße und können geringfügig abweichen.

All measurements are approximate and may vary slightly.

FACKELMANN® GmbH + Co. KG

Sebastian-Fackelmann-Str. 6
91217 Hersbruck • Deutschland
FAX: 09151/811-294
Servicetelefon: 09151/811-206
servicebm@fackelmann.de
www.fackelmann.com

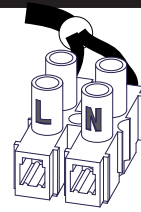

VDE 0100-701
IEC 60364-7-701 !

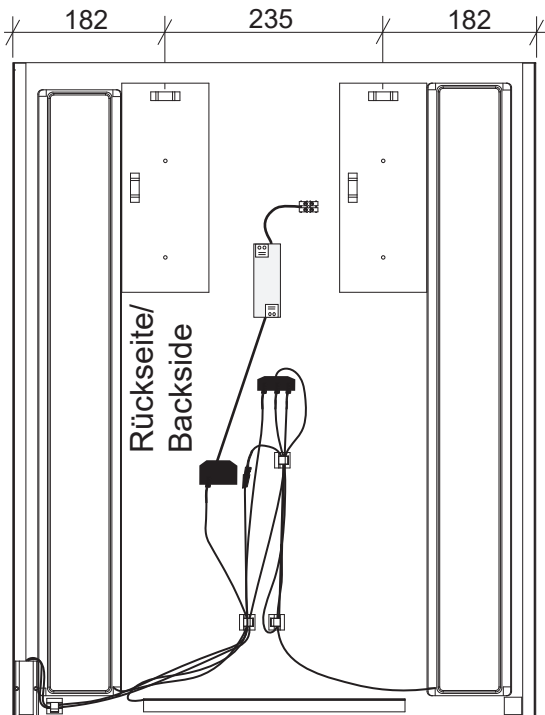

84513
84533

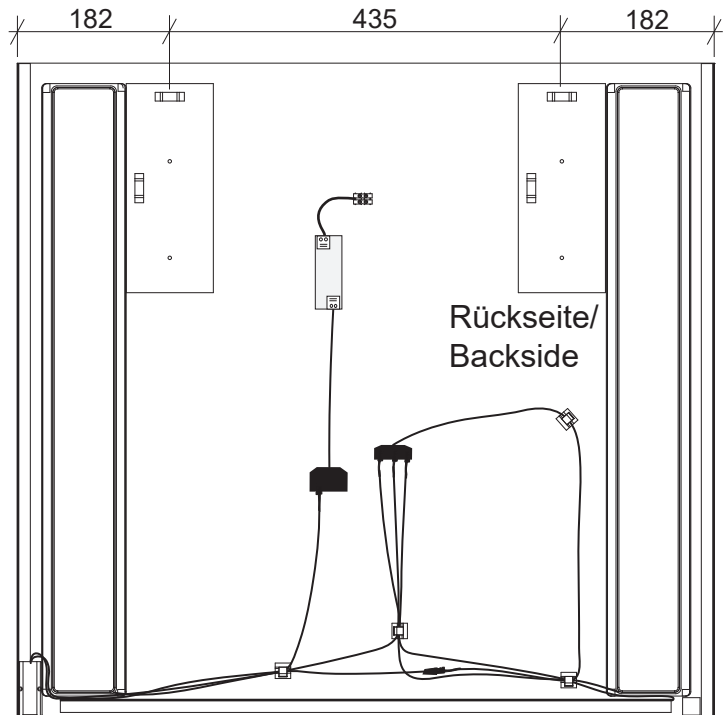

84514
84534

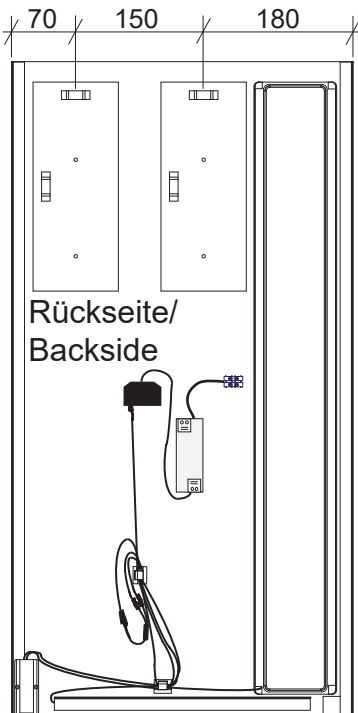

84512
84532

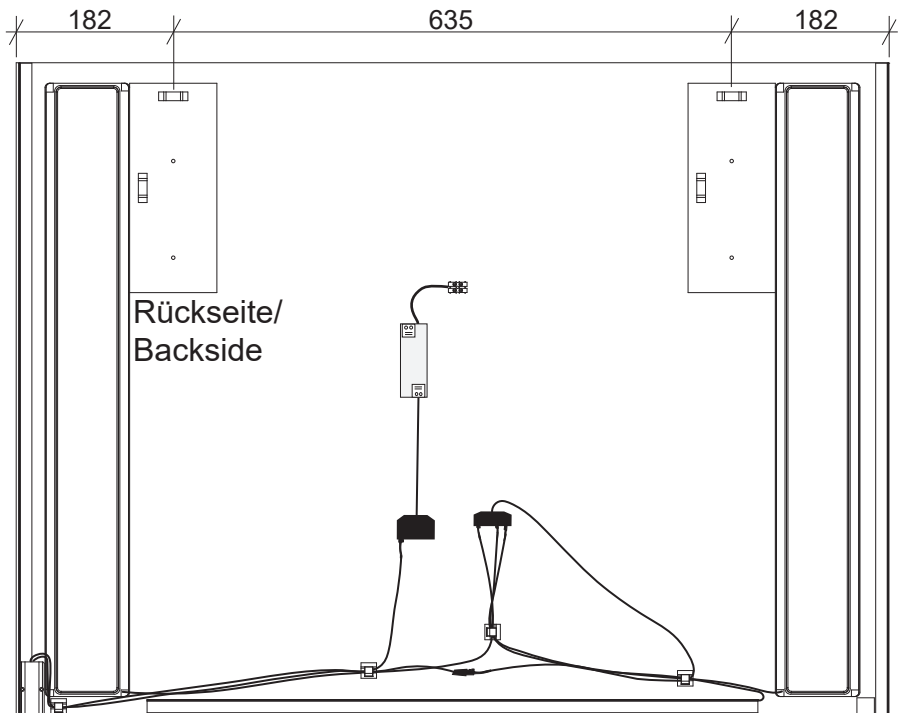

84515
84535

FACKELMANN®



Austausch Sensorschalter/
Change of sensor switch

Abbildungen beispielhaft.
Arbeitsfolge für alle Artikelnummern identisch.
Illustrations only exemplary.
Identical work sequences for all article numbers.

1

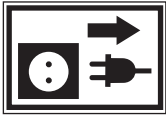

VDE 0100-701
IEC 60364-7-701

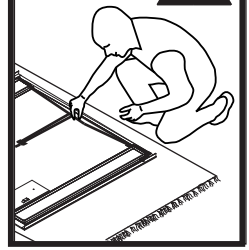

1.1

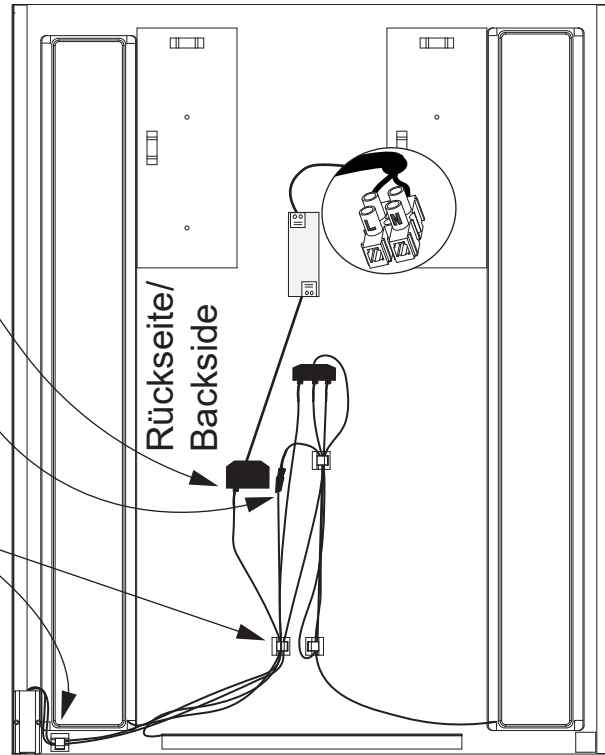
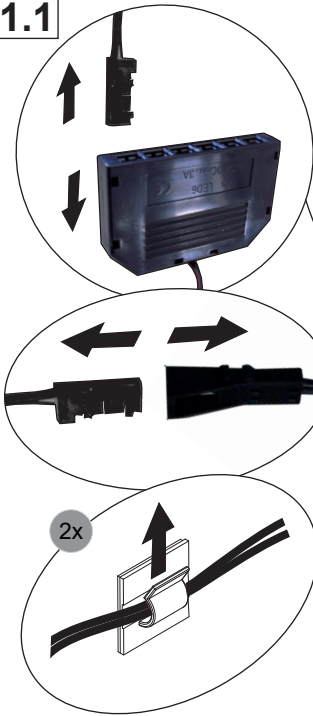

1.3

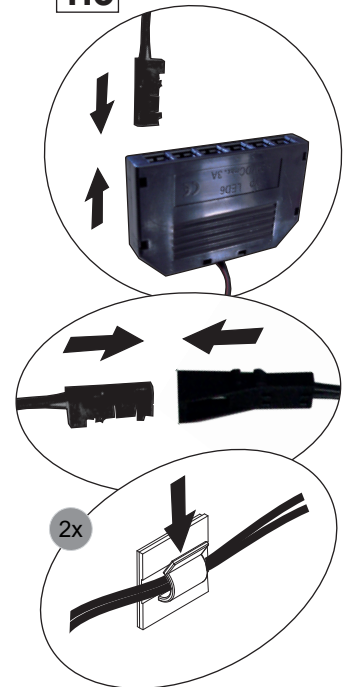

1.2

Ersatzteil/
Replacement part

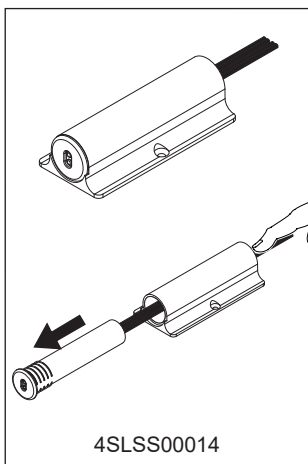

4SLSS00014

1 x

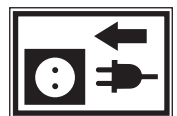
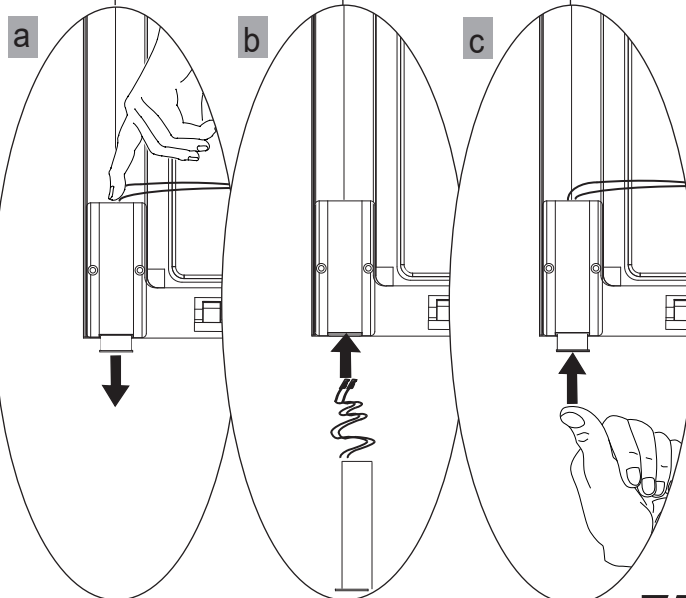

FACKELMANN

5BB0845130 S3 13/23



Austausch LED-Band der
Ambientebeleuchtung/
Change of LED-stripe of the
ambient lighting



Abbildungen beispielhaft.
Arbeitsfolge für alle Artikelnummern identisch.
Illustrations only exemplary.
Identical work sequences for all article numbers.

1

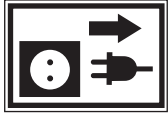

VDE 0100-701
IEC 60364-7-701

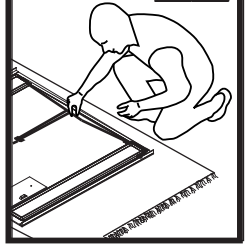

1.1

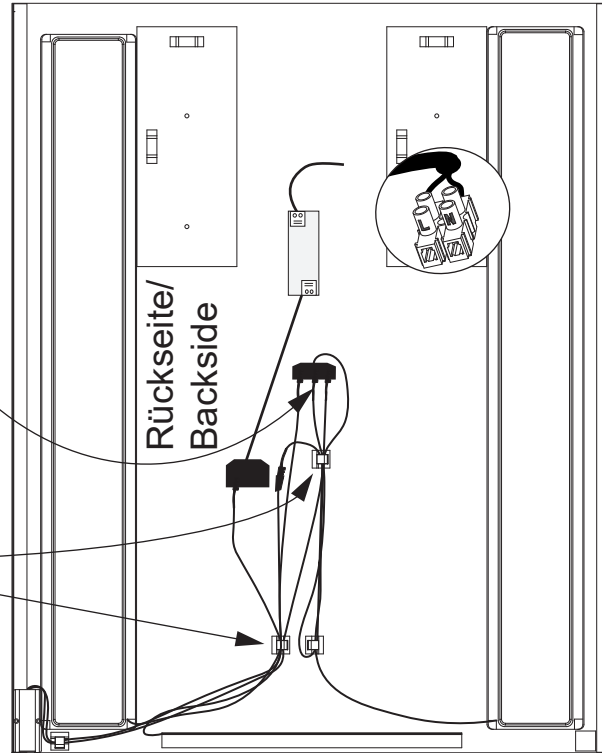
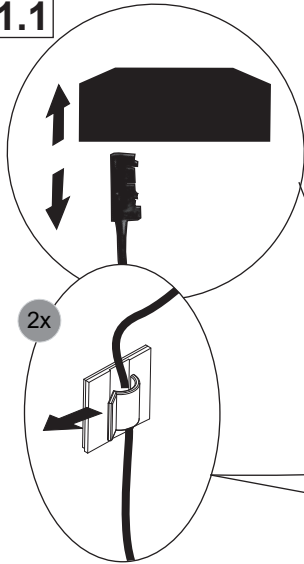

1.3

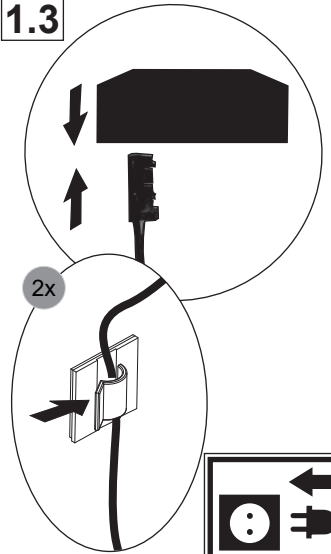

1.2

Ersatzteil/Replacement part		
84512/3	4SL0845120	
84532/3		
84514/5	4SL0845020	1x
84534/5		

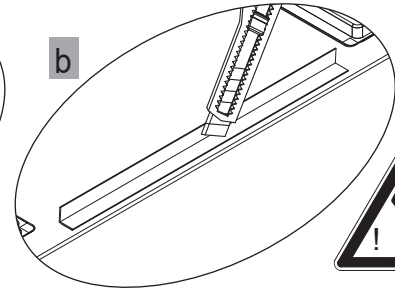
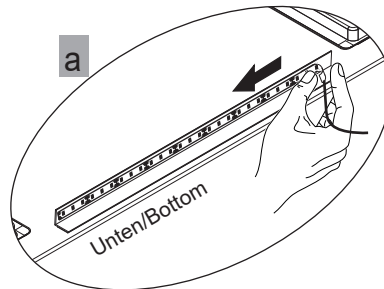

Klebereste vorsichtig entfernen/
Remove adhesive residues carefully

ACHTUNG: Heiß!
Caution! Hot!

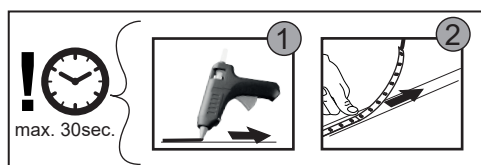
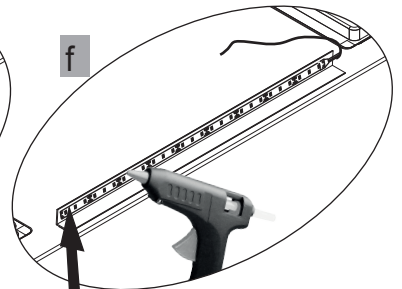
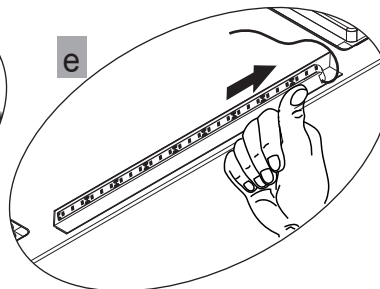
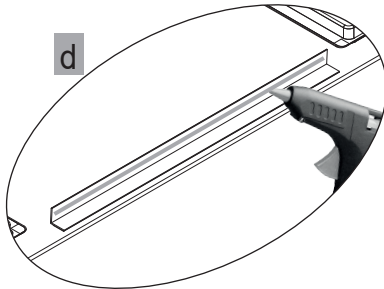
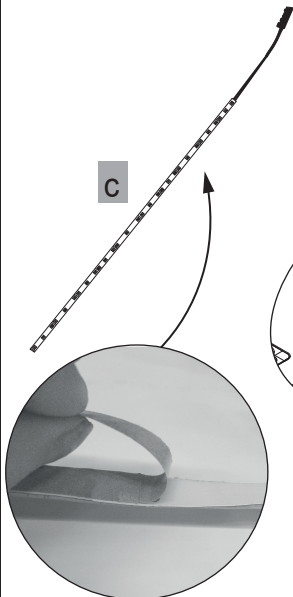

Obere Kante des LED-Bandes
mit Heißkleber fixieren/
Fix upper edge of LED-stripe
with hot glue

FAKELMANN



Austausch Kunststoffschalen
mit LED-Band/
Change of plastic shell with
LED-stripe

Abbildungen beispielhaft.
Arbeitsfolge für alle Artikelnummern identisch.
Illustrations only exemplary.
Identical work sequences for all article numbers.

1

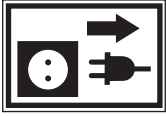

Artikel-Nr./ item number	Anzahl/number	Ersatzteil/ replacement part
84512 84532	1x	2MLSL84502
84513/4/5 84533/4/5	Frontansicht links/ front view left	1x 2MLSL84502
	Frontansicht rechts/ front view right	1x 2MLSR84502



1.1

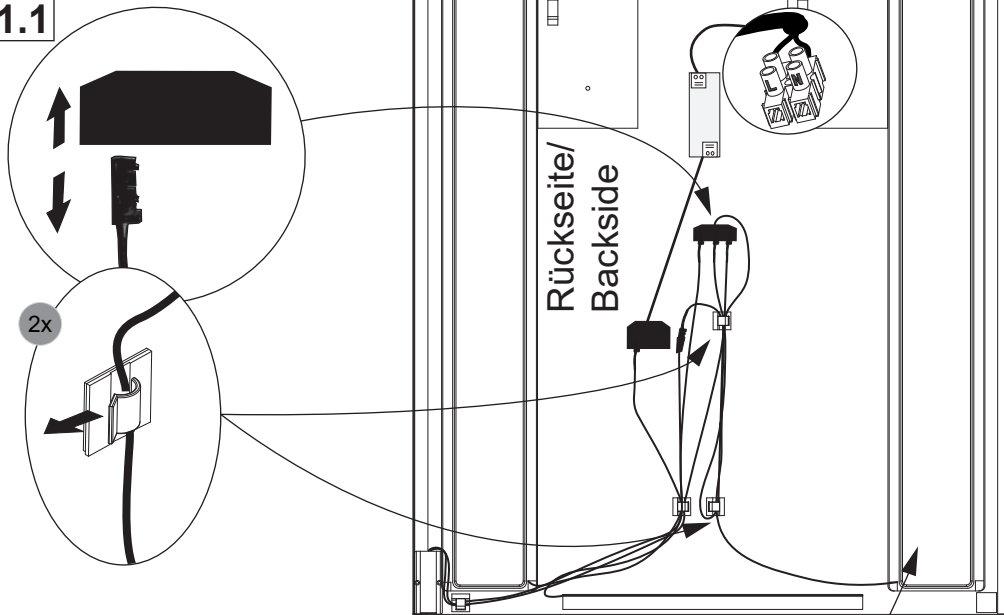

1.2

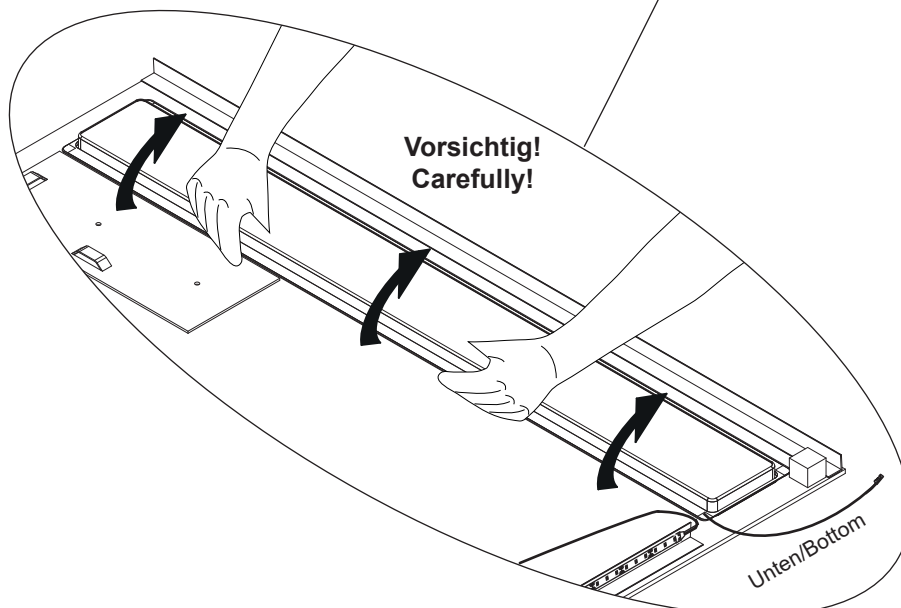

FACKELMANN®

5BB0845130 S5 13/23

2

2.1

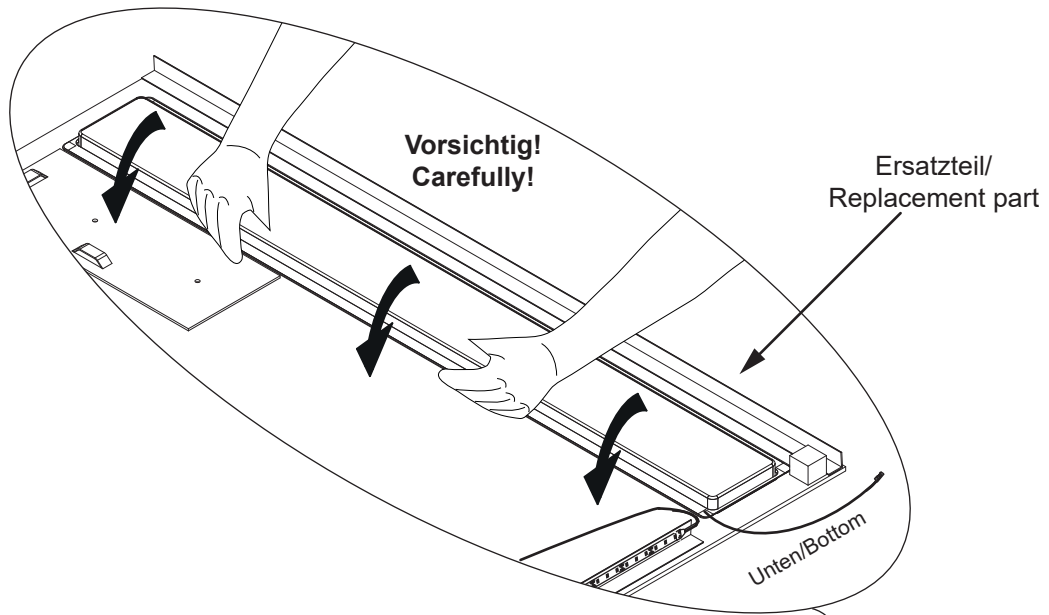

2.2

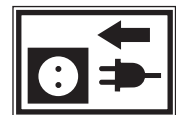
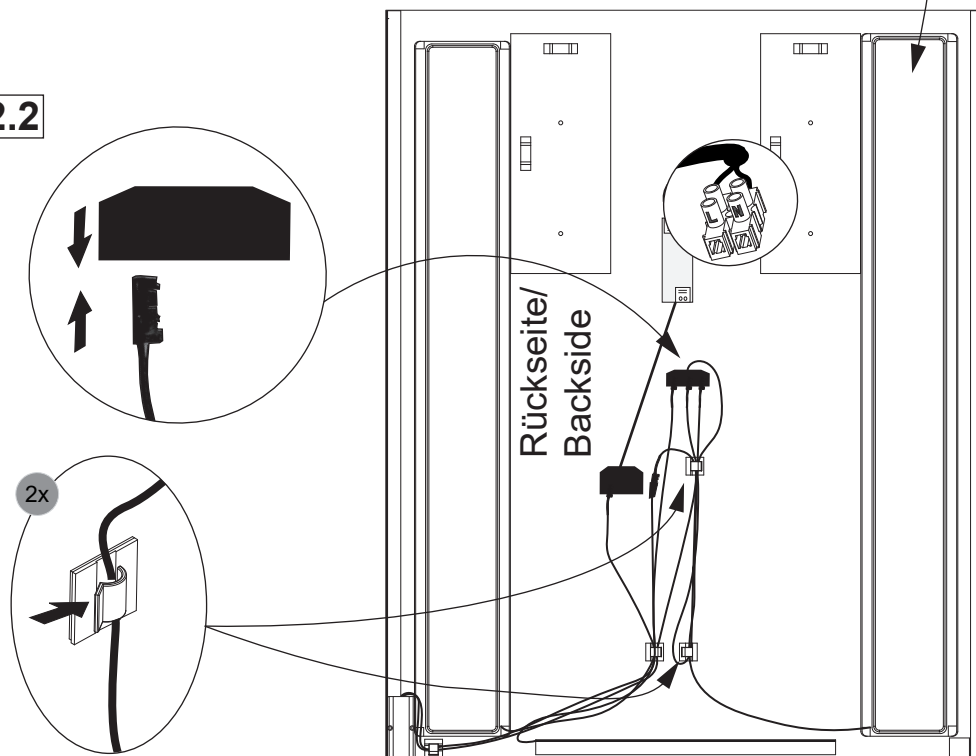

FACKELMANN®

5BB0845130 S6 13/23