

TRELLEBORG
8141/2503
2501/8142

- | | | | |
|-----------|--|-----------|---|
| D | MONTAGEANLEITUNG
BEDIENUNGSANLEITUNG | GB | ASSEMBLY INSTRUCTIONS
INSTRUCTION MANUAL |
| NL | HANDLEIDING VOOR DE MONTAGE
GEBRUIKSAANWIJZING | PL | INSTRUKCJA MONTAŻU
INSTRUKCJA OBSŁUGI |
| TR | MONTAJ TALIMATI
KULLANIM KLAVUZU | RU | ИНСТРУКЦИЯ ПО МОНТАЖУ
ИНСТРУКЦИЯ ПО ЭКСПЛУАТАЦИИ |
| RO | INSTRUCȚIUNI DE INSTALARE
INSTRUCȚIUNI DE UTILIZARE | IT | ISTRUZIONI DI MONTAGGIO
MANUALE DI ISTRUZIONI |
| FR | NOTICE DE MONTAGE
MANUEL INSTRUCTIONS | SK | MONTÁŽNY NÁVOD
NÁVOD NA POUŽITIE |
| HU | KÖZGYŰLÉS UTASÍTÁSOK
KEZELÉSI UTASÍTÁS | CZ | MONTÁŽNÍ NÁVOD
NÁVOD K POUŽITÍ |
| SI | NAVODILA ZA MONTAŽO
NAVODILA ZA UPORABO | PT | INSTRUÇÕES DE MONTAGEM
MANUAL DO USUÁRIO |
| ES | INSTRUCCIONES DE MONTAJE
MANUAL DEL USUARIO | HR | UPUTE ZA MONTAŽU
UPUTE ZA UPOTREBU |

B/F

210410

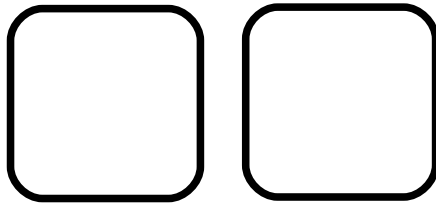

0019

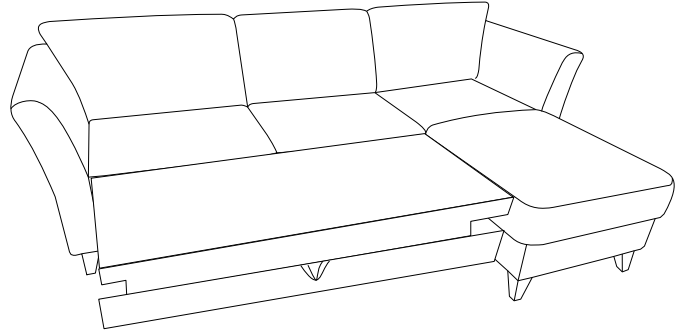
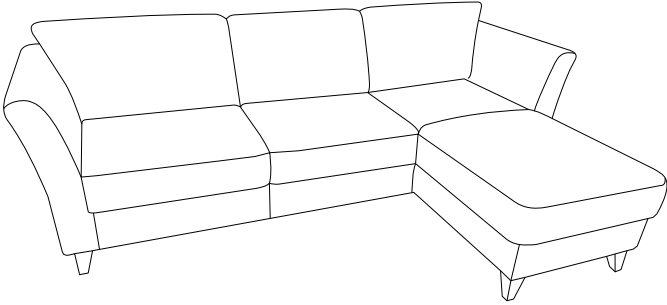

0019

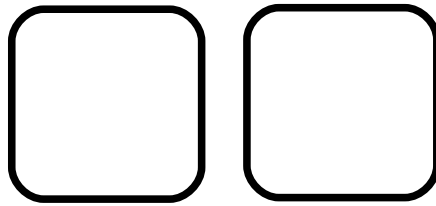

0089

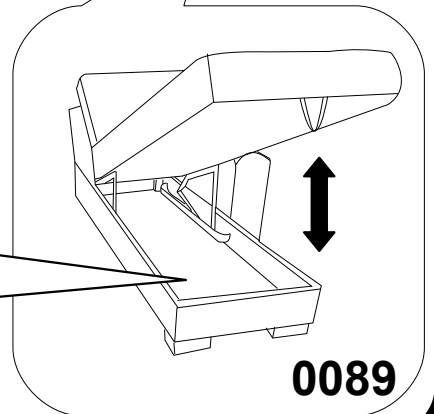
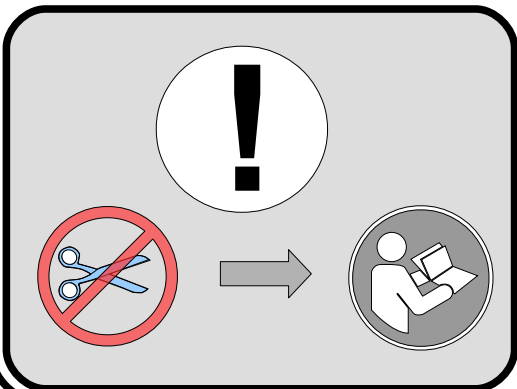
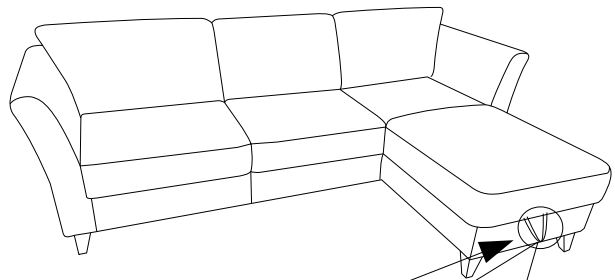
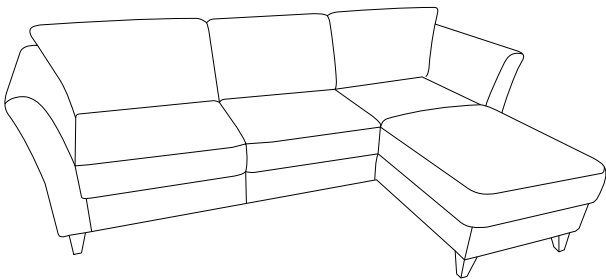

0089



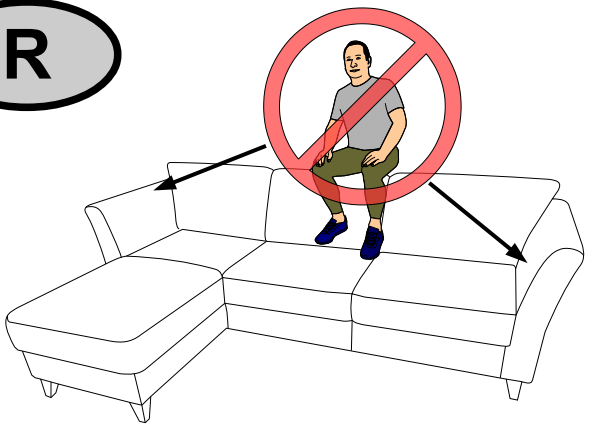

R

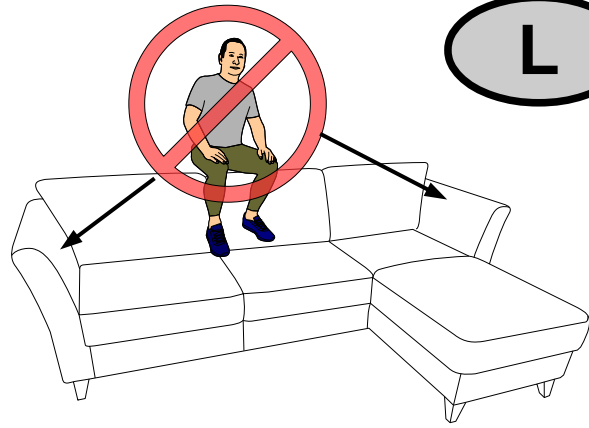







L

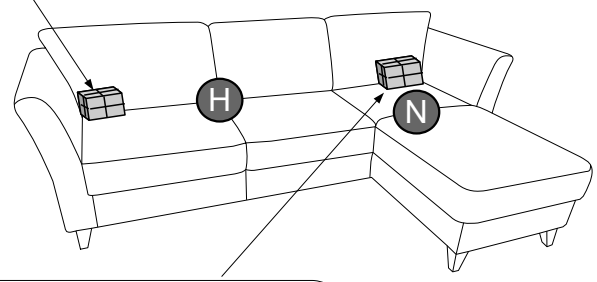
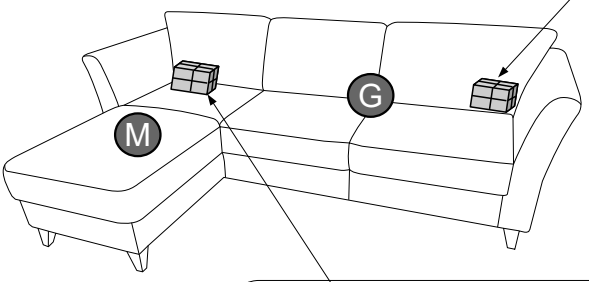

0
10
20
30
40
50
60
70
80
90
100
110
120
130
140
150
160
170
180
190
200

X Fi- 35  X2	S H- 120  X2	q M8*110  X2	i L- 5  X1	[mm]
--	--	--	---	------





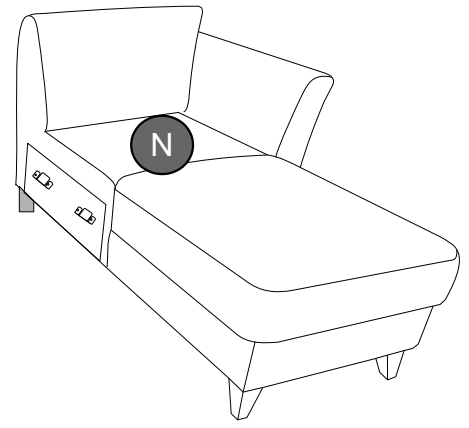
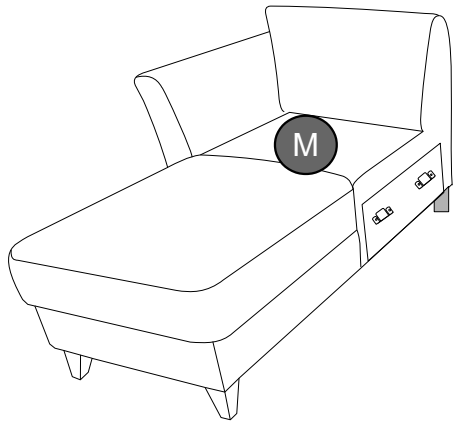
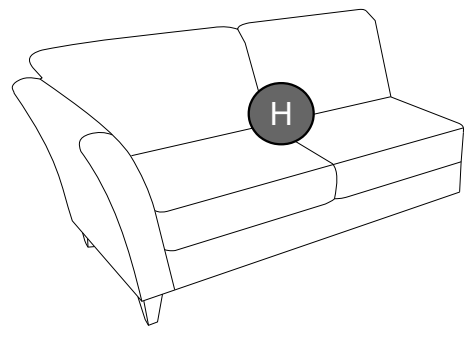
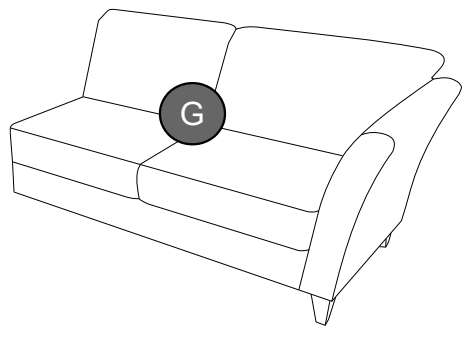

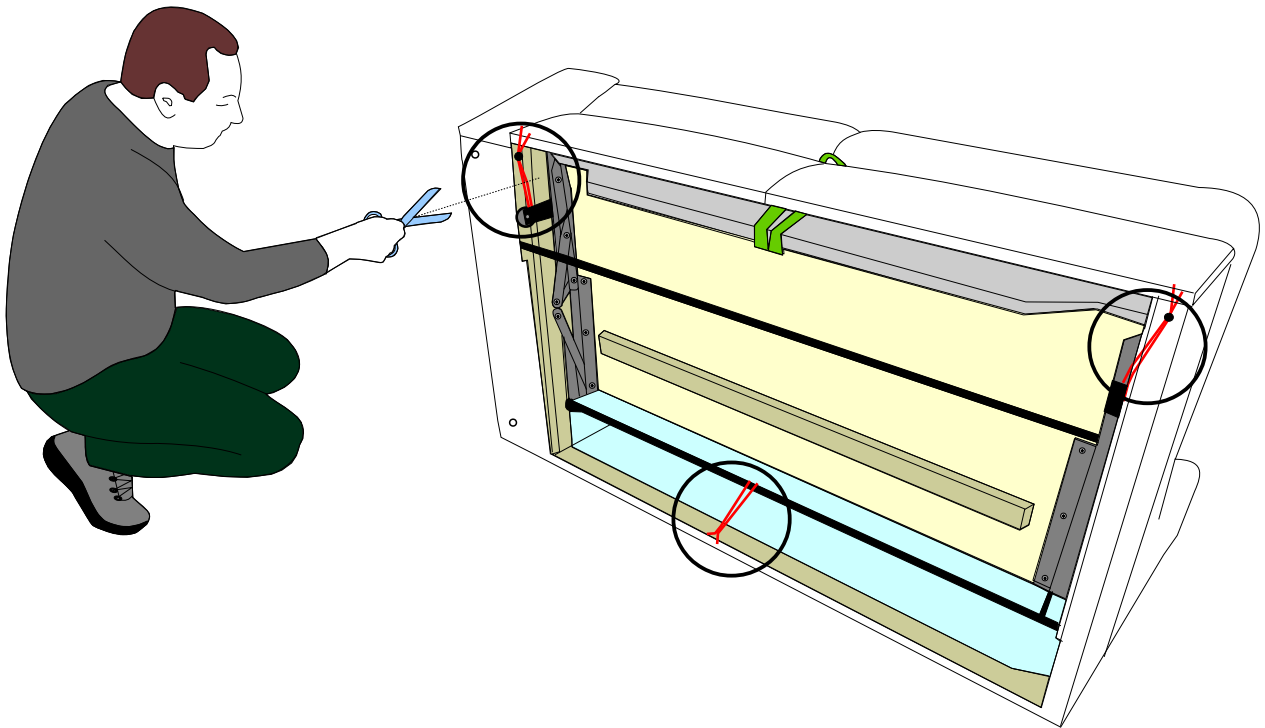
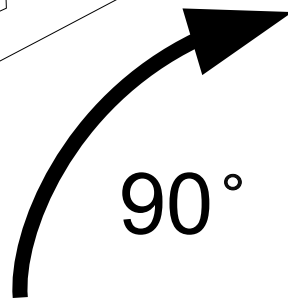
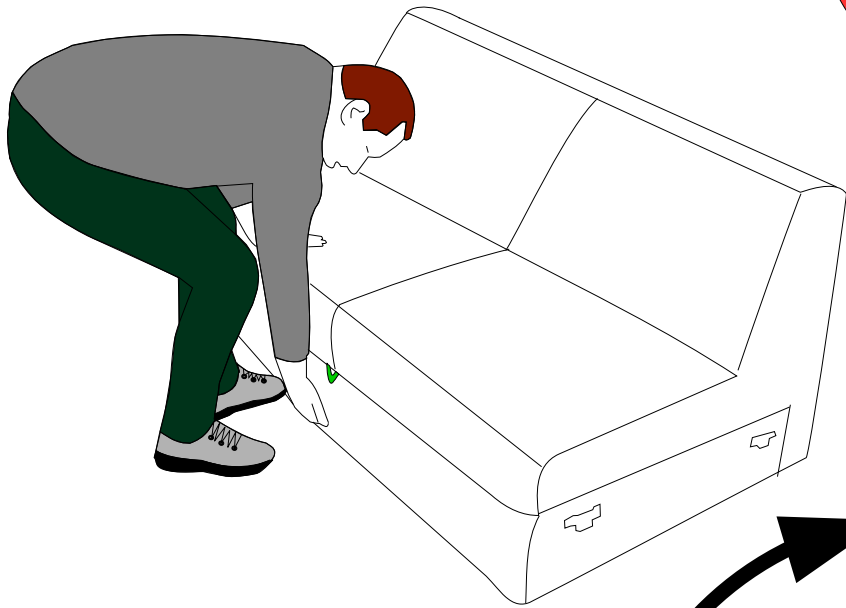

f H- 120  X1	Z H-120  X1	X Fi- 35  X4	S H- 120  X4	q M8*110  X4	i L- 5  X1
--	---	--	--	---	--





0019

f H-120  X1	Z H-120  X1	X Fi-35  X6	S H-120  X6	q M8*110  X6	i L-5  X1
---	---	---	---	---	---

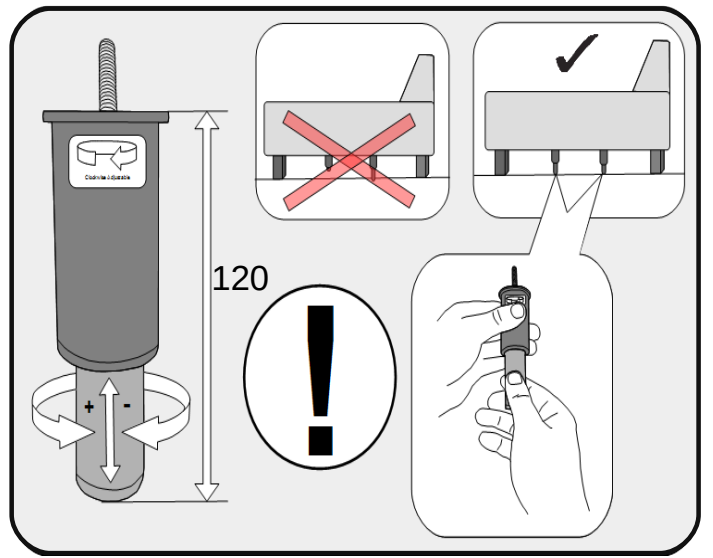
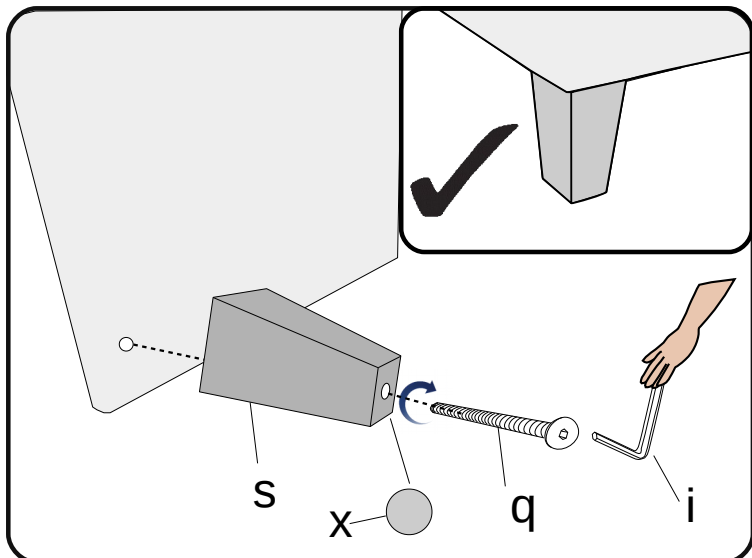
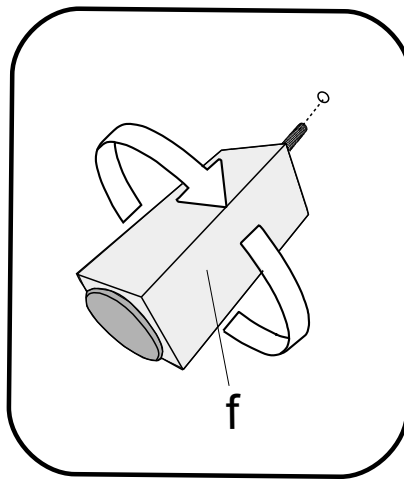
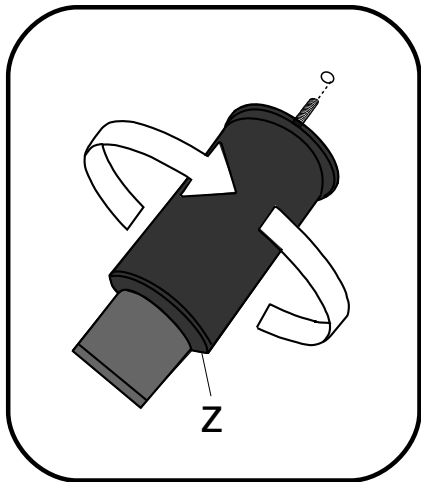
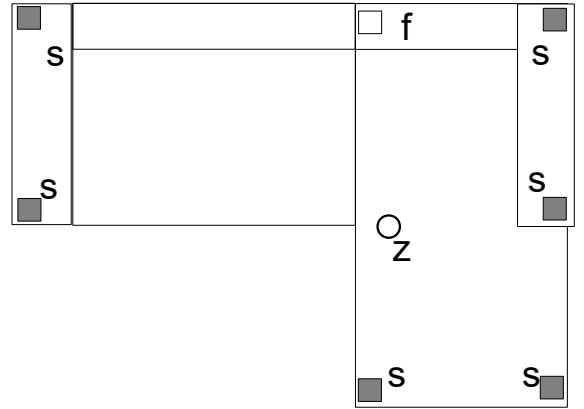
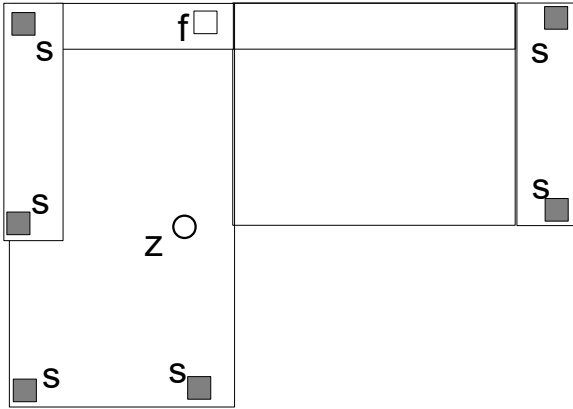
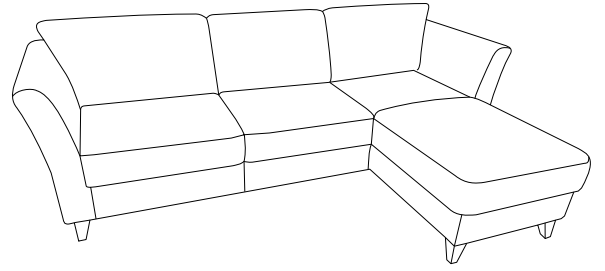
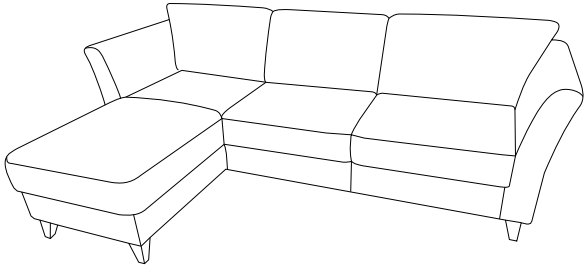

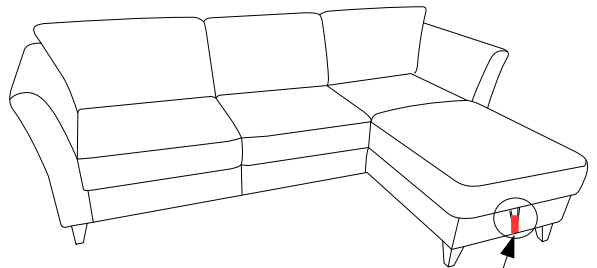
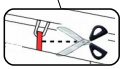
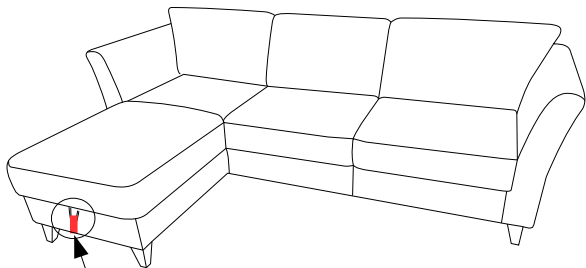
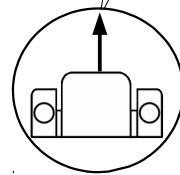
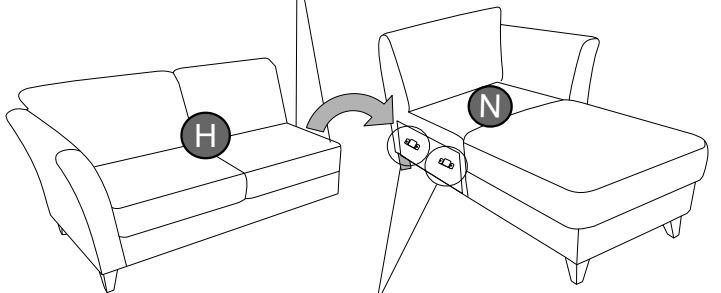
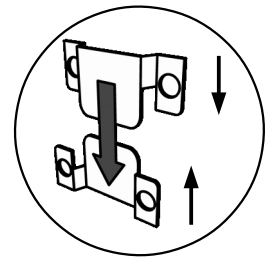
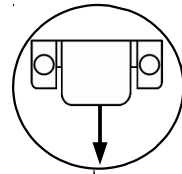
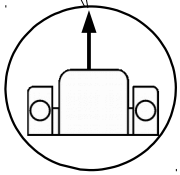
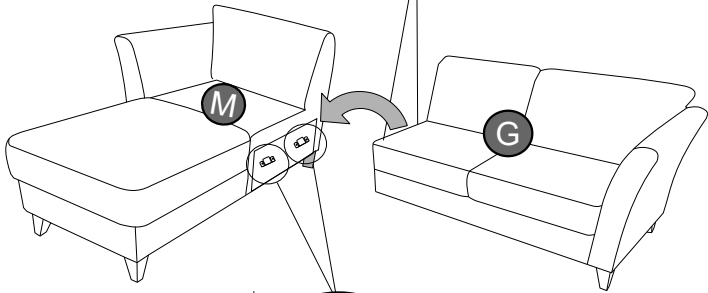
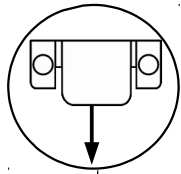
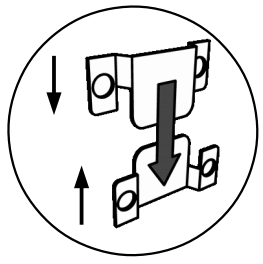
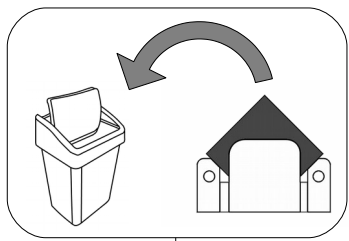

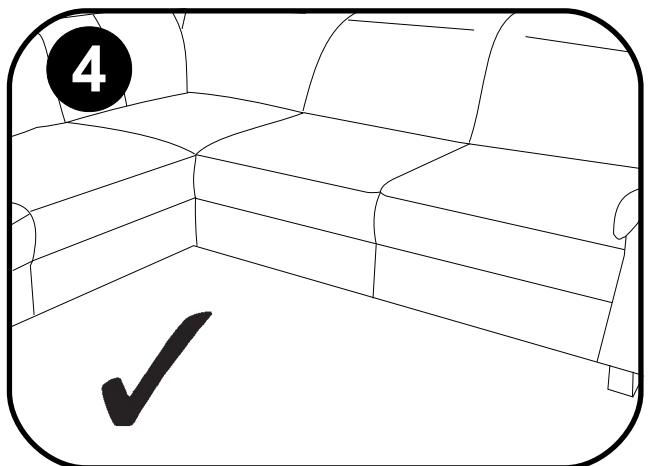
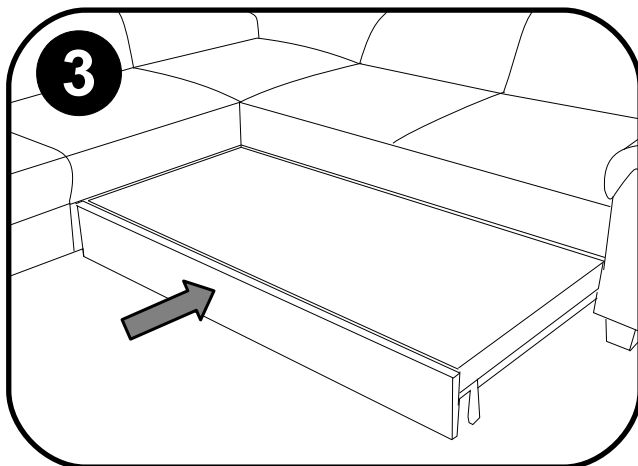
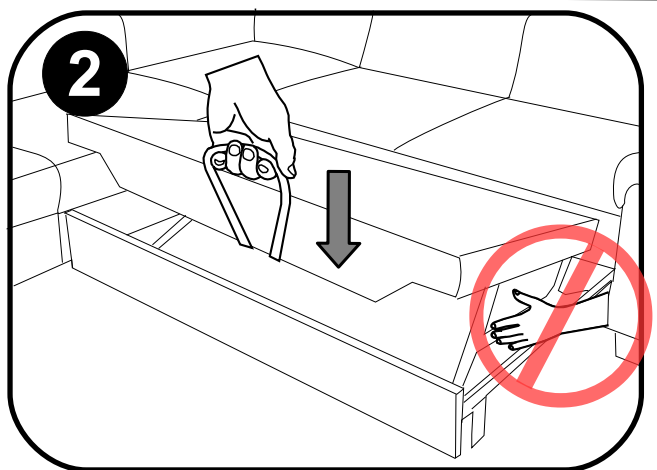
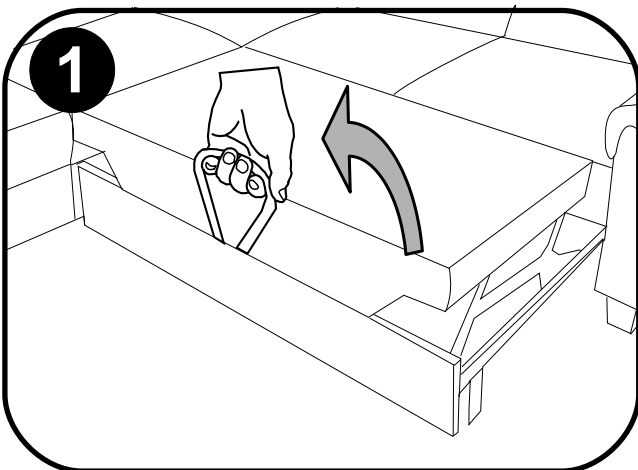
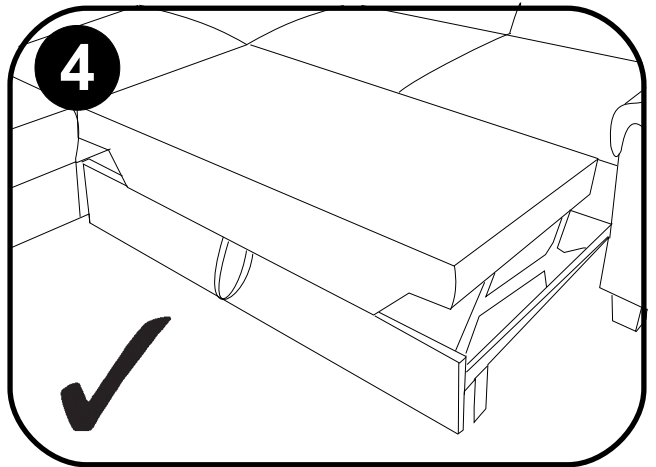
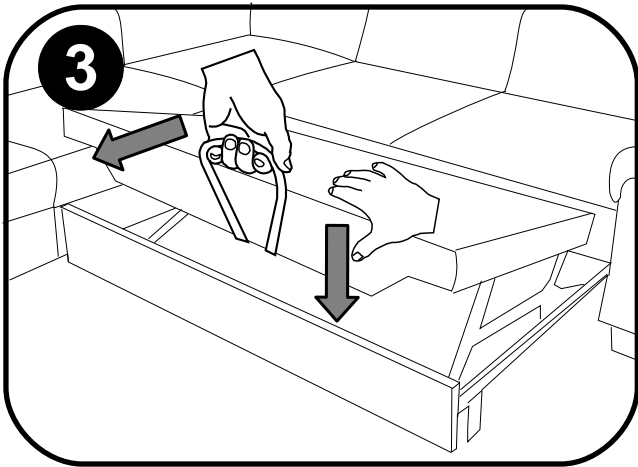
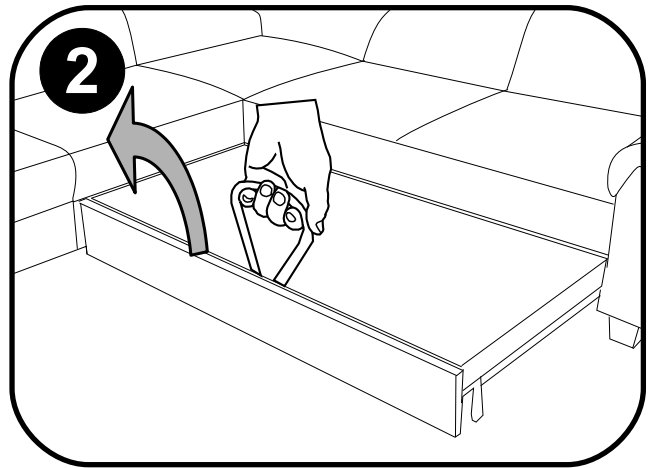
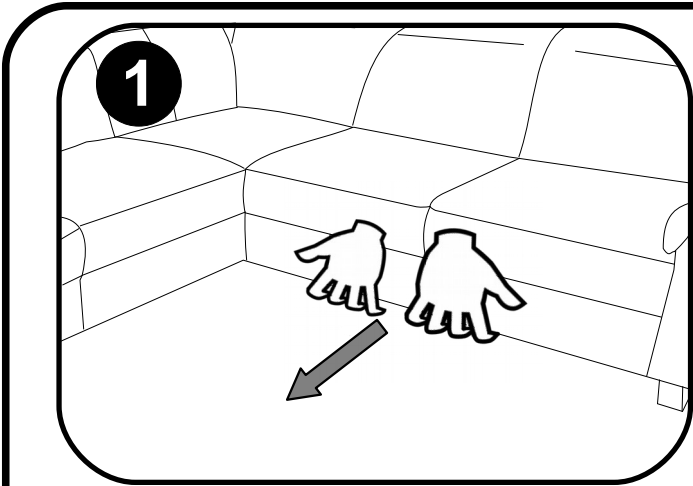
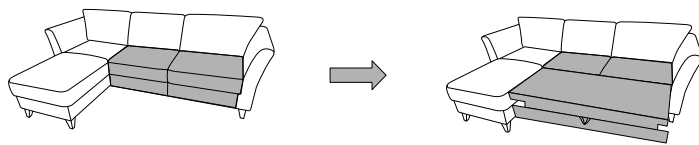

Name · Naam · Nazwa · Ísim · Название · Nume · Nome · Názov · Názov ·
 Název · Neve

TRELLEBORG

Typ · Type · Tip · Тип · Tipo · Típus

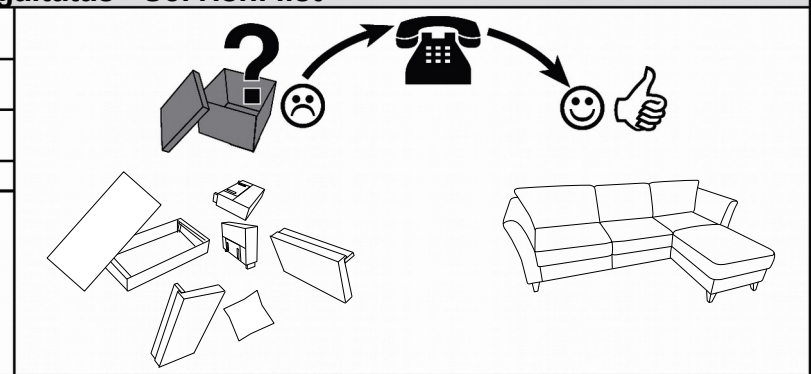
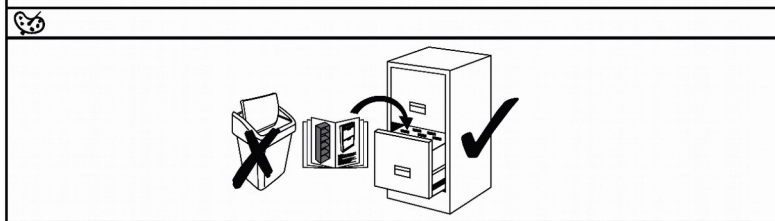

R

L

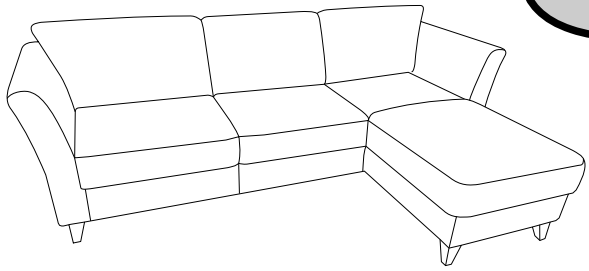
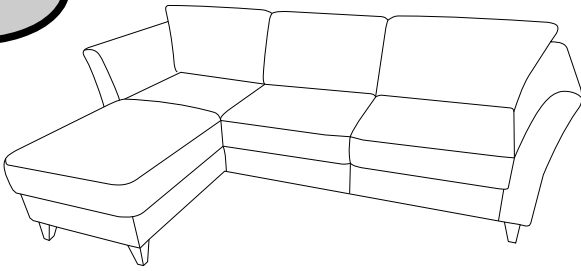

f H- 120	Z H- 120	X Fi- 35	S H- 120	q M8*110	i L- 5 [mm]

