

LKZ: X0105

Modellname / Model name / Nom du modèle / Modellnamn / Nome modello / Název modelu / Modelnaam / Ime modela / Numéro Modelo / Modell neve / Название модели / Názov modelu / Ime modela / Denumire model / Наименование на модела / Nazwa modelu

FRENO

Modellnummer / Number / Numéro du modèle / Numero / Номер на модела / modello / Číslo modelu / Modell száma / Éislo modelu / Številka modela / Număr model / Broj modela / Modelnummer / Numer modelu

X30 A2 T11

Type / Tipo / Típus / Typ / Тип / Tip

T11

22.11.2021

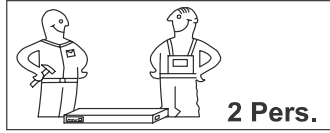

2 Pers.

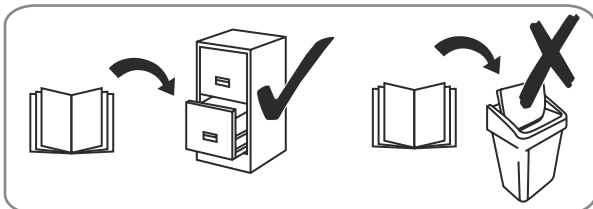
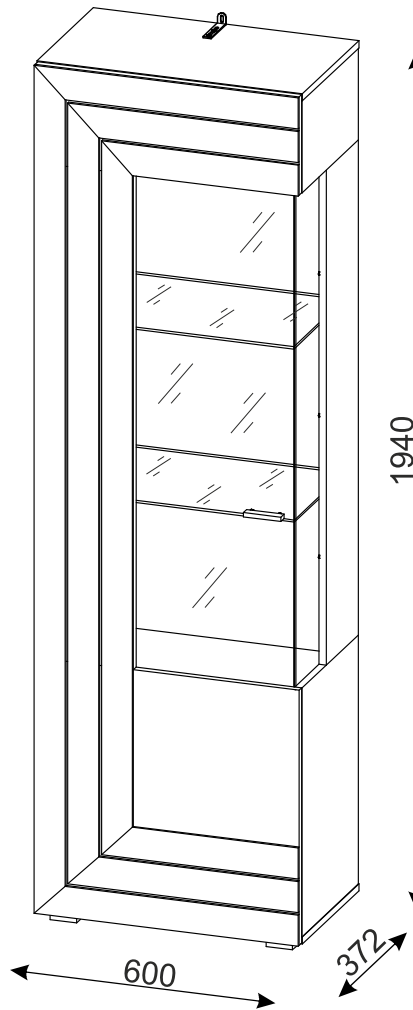
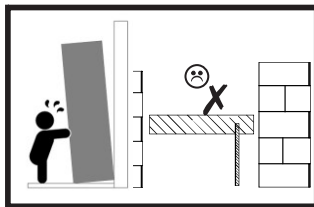
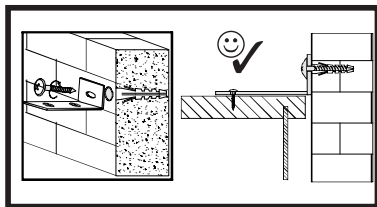
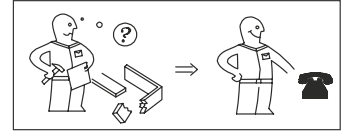
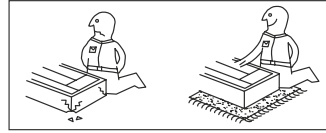

Wichtig - Für spätere Verwendung aufbewahren - sorgfältig lesen!

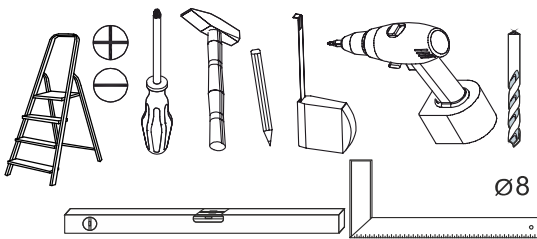

2 Pers.



60 min



festziehen / tighten / Затягнете / serrer / stringere / utåhnut / vasttrekken / zategnuti / strângere / zwiázac / zacisnac / szorosan meghúzni / pevne dotiahnut / trdno pritegniti / затянуть / dra át



eindrücken / press in / enfoncer / wcisnac / ribattere / zatlačit / Вкарайте / Indrukken / benyomni / silacit' / vtisni / tryck in / introducere prin apăsare / вдавить



ausmessen / measure / mesurer / măsurare / opmeten / izmeriti / miara / kimérni / izmeriti / măsurare / измерить / změřit / Измерете / mät upp / zmierzyc



drücken / press / presser / stisknout / Натиснете / vtisni / nasnac / drukken / pritisnuti / nacisnac / pritisniti / нажать / (meg)nyomni / apasare / tryck fast / nacisnac



einschlagen / hammer in / beverni / slå in / frapper au marteau / infossare / Zabit' / zarazit / Набийте / zabiti / wbić / introduce prin bătaie / забить / залуц



Drehen - wenden / przekreć - odwrócić / Keren - omdraaien / Girare - Ruotare / Okrenuti - ubnuti / Retourner - renverser / Turn over - turn around / Otocte - obratit / Zавърте - обърнете / Obrnite list / Întoarceți - rotiți / Vrid runt - vänd / прокрутить - повернуть / otočit - obrátit / elforgatni - megfordítani

LKZ: X0105

Modellname / Model name / Nom du modèle / Modellnamn
Nome modello / Název modelu / Modelnaam / Ime modela
Número Modelo / Modell neve / Название модели /
Názov modelu / Ime modela / Denumire model /
Наименование на модела / Nazwa modelu

FRENO

Modellnummer / Number / Numéro du modèle
Numero / Номер на модела / modello
Číslo modelu / Modell száma / Éislo modelu
Številka modela / Număr model / Broj modela
Modelnummer / Numer modelu

X30 A2 T11

Type / Tipo / Típus / Typ / Тип / Tip

T11

22.11.2021

D Unser Direktservice für Beschlagteile
Sollte Ihnen ein Beschlagteil fehlen, können Sie diese Servicekarte
direkt an die untenstehende Adresse mailen. Wir können allerdings
nur Beschlagteile auf diesem Wege verschicken. Sollten Sie eine
andere Beanstandung an Ihrem Möbelstück haben, so wenden Sie
sich bitte direkt an Ihr Möbelhaus.

GB Our direct order service for fitting
If a fitting part is missing, you can e-mail this service card directly
to the address below. However, we can only send fitting parts in
this way. If you have any other cause for complaint concerning
your item of furniture, please contact your furniture store directly.

CZ Naše přímé služby pro kování
Chybí-li vám nějaký díl z kování, můžete tuto servisní kartu odeslat
e-mailem přímo na níže uvedenou adresu. Touto cestou však
můžeme rozeslat jen díly kování. Pokud byste reklamovali jiný díl
nábytku, obraťte se přímo na svého prodejce nábytku.

F Bien étudier la notice de montage
S'il vous manque une ferrure, veuillez envoyer directement la présente
carte service à l'adresse e-mail indiquée ci-dessous. Cependant, ceci
nous permet uniquement d'envoyer des ferrures. Pour tout autre type
de réclamation concernant votre meuble, veuillez contacter
directement votre magasin d'ameublement.

I Il nostro servizio diretto per l'ordine della ferramenta
Qualora Vi dovesse mancare un pezzo di fissaggio, allora Vi
preghiamo di inviare questa carta di servizio immediatamente
all'indirizzo sottostante. Possiamo inviare i pezzi di fissaggio
solamente per mezzo di questo procedimento. Qualora doveste
avere qualche altra reclamazione in merito al mobile, allora Vi
preghiamo di rivolgerVi direttamente al Vostro Negozio di mobili.

BG Нашата директна услуга за обков
Ако липсват части от комплекта, използвайте настоящата
сервисна карта и ни изпратете на e-mail адреса, посочен
по-долу. По този начин можем да доставим само липсващи
елементи от обкова. Ако установите други дефекти по
мебелите, Ви съветваме да се обърнете към мебелната
къща/магазин, от който сте закупили стоката.

NL Onze directservice voor losse onderdelen
Wanneer er een onderdeel ontbreekt, kunt u deze servicekaart
direct aan onderstaand e-mailadres sturen. Wij kunnen langs deze
weg echter alleen beslagdelen versturen. Mocht u een ander
probleem aan uw meubel hebben, verzoeken wij u contact op te
nemen met uw meubeldealer.

PL Nasz bezpośredni serwis czeski montażowych
Jeżeli brakuje części koniecznych do montażu, prosimy o przesłanie
nam niniejszej karty serwisowej na niżej podany adres e-mailowy.
W ten sposób możemy przesłać Państwu tylko brakujące części.
W przypadku innych reklamacji dotyczących mebla, prosimy zgłosić
się do salonu meblowego, w którym został dokonany zakup.

HR Servis za okove
U slučaju da nedostaje neki od dijelova molimo vas da na dolje
navedenu mail adresu pošaljete ovaj servisni obrazac. Na ovaj način
mogu se dostaviti samo okovi. U slučaju da imate dodatne prigovore
vezane uz komad namještaja molimo vas da se obratite izravno
trgovini namještaja gdje je isti kupljen.

HU Direktszolgálatunk vasalatók esetén
Ha hiányzik egy vasalat, ezt a kártyát közvetlenül elküldheti az
alább található címre. Azonban csakis vasalatókat tudunk így
küldeni. Amennyiben másfajta reklamáció áll fenn bútordarabját
illetően, forduljon közvetlenül a bútortárházhoz.

SK Naš priamy servis pre časti kovania
Ak by Vám chýbala nejaká časť kovania, môžete poslať
túto servisnú kartu poslať e-mailom na nižšie uvedenú
adresu. Diely kovania vieme poslať iba týmto spôsobom.
Ak by ste mali inú reklamáciu ohľadom Vašho nábytku,
obráťte sa priamo na Vašu predajňu nábytku.

SLO Naše direktno uslužne storitve za okovje
Če vam manjka kakšno okovje, lahko to servisno kartico pošljete
po e-pošti direktno na spodnji naslov. Po tej poti vam lahko
pošljemo samo okovje. Če želite reklamirati kakšen drug del
pohištva, se obmite neposredno na vašo trgovino pohištva.

RO Service-ul nostru direct pentru feronerie
În cazul în care vă lipsește o piesă de feronerie puteți să trimiteți
direct acest card de service prin e-mail la adresa de mai jos. Noi
nu putem expedia piese de feronerie decât pe această cale.
Dacă aveți o altă reclamație referitoare la piesa de mobilier,
atunci vă rugăm să vă adresați direct la magazinul dvs. de mobilă.

RUS Наш прямой сервис для поставок фурнитуры
Если окажется, что Вам не хватает того или иного элемента
фурнитуры, Вы можете отправить сервисную карту по факсу
непосредственно на нижеприведенный адрес электронной
почты. Однако, таким образом мы можем переслать лишь
фурнитуру. Если же у Вас возникнут иные претензии относительно
приобретенной мебели, пожалуйста, обращайтесь
непосредственно в организацию, осуществившую продажу.

S Vår direktservice för beslagsdelar
Om du saknar en beslagsdel kan du skicka detta servicekort direkt
till e-postadressen som anges nedan. Tänk på att detta är den enda
möjligheten att skicka beslagsdelar till dig. Om du vill reklamera din
möbel av en annan anledning måste du kontakta ditt möbelfhus direkt.

ES Nuestro servicio directo para accesorios
Si le falta algún accesorio, puede enviar esta tarjeta de servicio directamente
a la siguiente dirección. No obstante, por este método solo podemos
enviar accesorios. Si tiene alguna otra objeción sobre su mueble, consulte
directamente con su mueblería.

TR Donatılar için doğrudan servisimiz
Bir donatınız eksikse bu servis kartını doğrudan aşağıda bulunan adrese
doğrudan mail yazabilirsiniz. Sadece bu yolla donatıları gönderebiliriz.
Mobilyanızda başka şikayetleriniz varsa lütfen doğrudan mobilya satıcınıza
danışın.

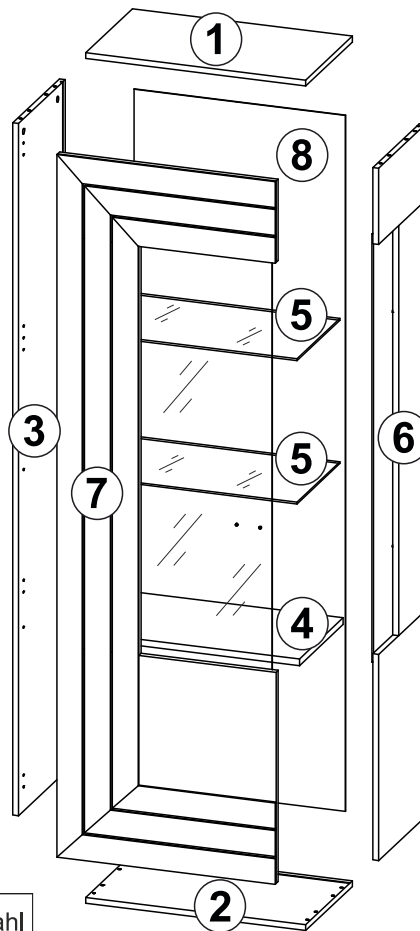
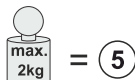
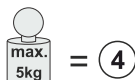

Nr.	Maße mm			Colli	Anzahl
1	600	350	16	1/2	1
2	600	350	16	1/2	1
3	1888	350	16	1/2	1
4	565	328	16	1/2	1
5	558	300	5	1/2	2
6	1888	350	20	2/2	1
7	1916	596	22	2/2	1
8	1898	576	3	2/2	1
B1				1/2	1

Grund der Beanstandung / Reason of the objection:

Möbelhaus / Furniture store:

Name / Name: Telefon / Telephone:

PLZ / postal code: Ort / City:

Strasse / Street:

Haus-Nr. / House No.: @E-Mail:

E-Mail Kundenservice / Customer service e-mail / E-mail servisního střediska / E-mail de notre service clientèle / e-mail servizio clienti / E-mail на отдела за
обслужване на клиенти / E-mail klantenservice / E-mail servisu dla klientów / Servisna mail adresa / Az ügyfélszolgálat e-mail címe / E-mail zákaznického
servisu / E-pošta Servisna služba / E-mail Serviciu clienți / E-Mail сервисной службы / E-postadress kundservice / Servicio de atención por correo electrónico / Müşteri hizmetleri e-postası

service@xonox-home.com
Hotline xonox.home GmBH
0049-(0)5261-9202800

LKZ: X0105

Modellname / Model name / Nom du modèle / Modellnamn
Nome modello / Název modelu / Modelnaam / Ime modela
Número Modelo / Modell neve / Название модели /
Názov modelu / Ime modela / Denumire model /
Наименование на модела / Nazwa modelu

FRENO

Modellnummer / Number / Numéro du modèle
Numero / Номер на модела / modello
Číslo modelu / Modell száma / Ěíslo modelu
Številka modela / Numár model / Broj modela
Modelnummer / Numer modelu























X30 A2 T11

Type / Tipo / Típus / Тип / Тип / Tip

T11

22.11.2021

B1 (COLLI 1/2)

A0  Ø8x30 x12	B0  x4	B1  Ø7x50 x4	C0  x24	C2  x8	C7  16 mm x8	D0  3x15 x20	D5  3.5x16 x8	D21  5x13 x1	D37  4x20 x8	E0  8x50 x1
H7  4x10 x2	J45  x4	J56  x4	K  4mm x1	L54  x1	M1  x20	P0  x1	T19  x4	Q11  x8	U0  x3	U1  x2

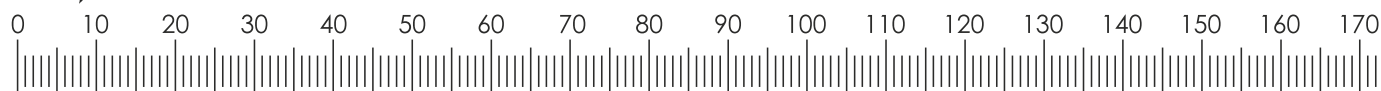
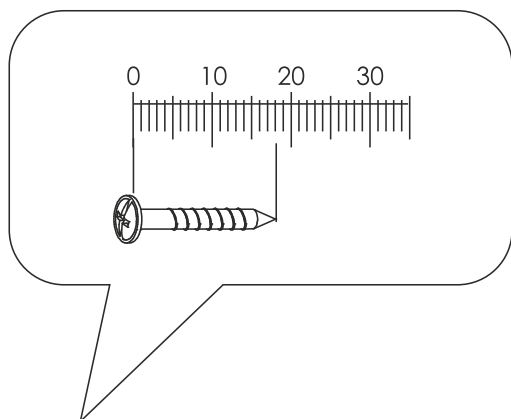

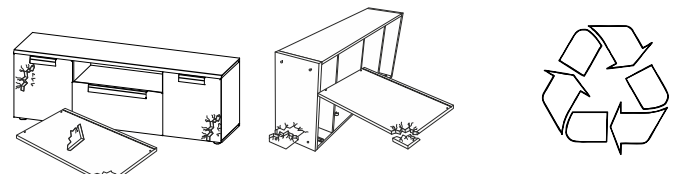
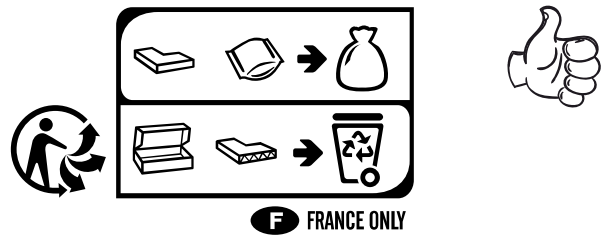
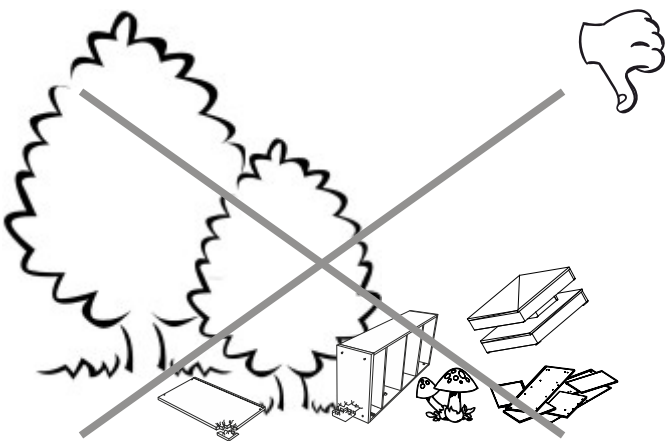
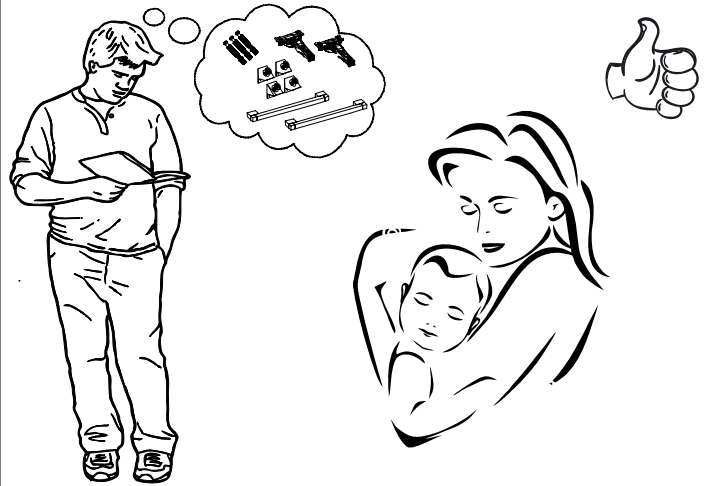
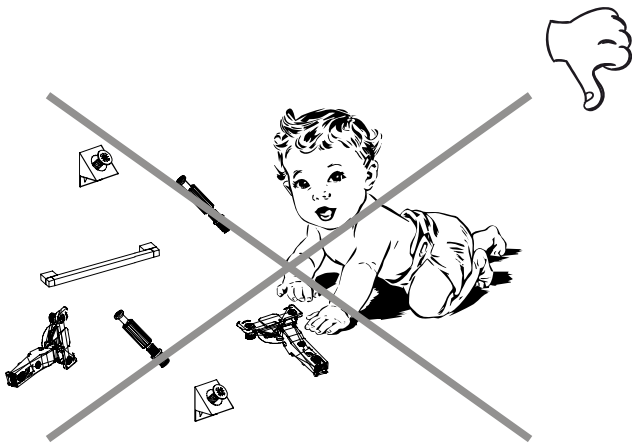
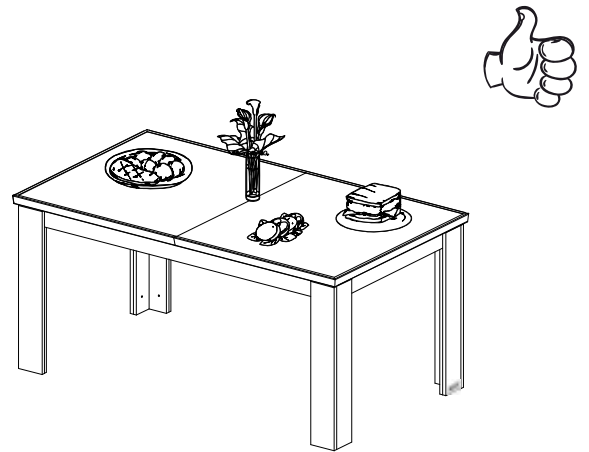
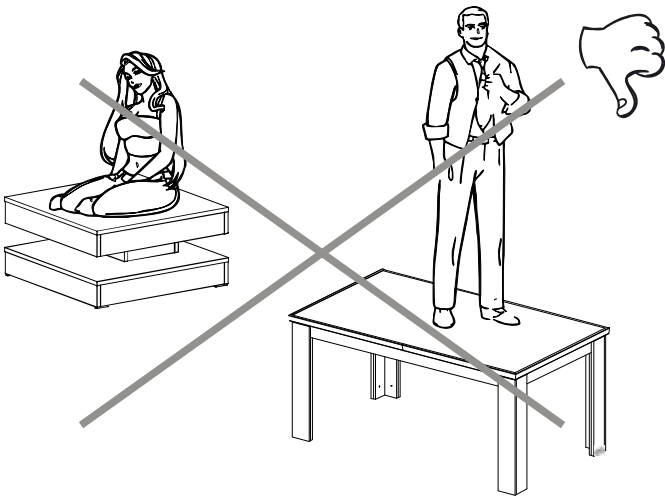
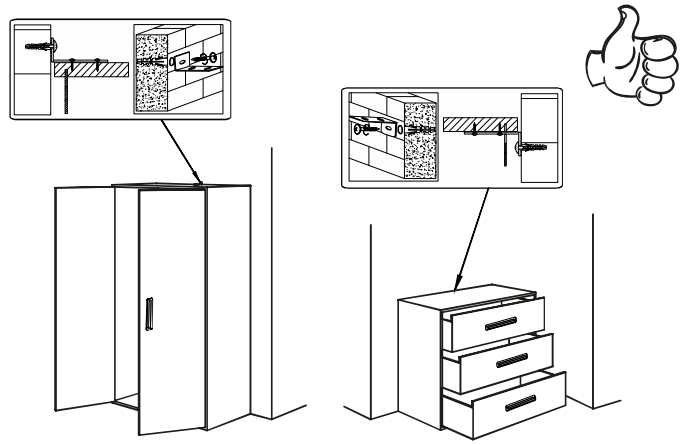
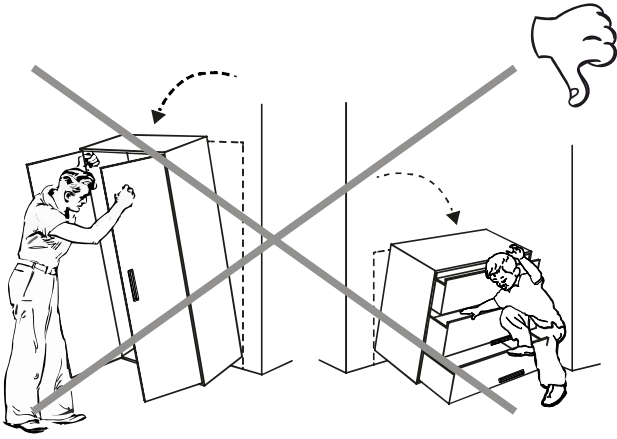

(D) Sehr geehrter Kunde,

als Möbelproduzent möchten wir Sie darüber informieren, dass eine Befestigung nur so gut ist wie die Verbindung zwischen Befestigungsmaterial (Dübel) und Mauerwerk. Prüfen Sie bei Hängeelementen Ihr Mauerwerk und verwenden Sie nur dafür vorgesehene Dübel aus einem Fachmarkt. Letztendlich ist der Monteur für die Befestigung am Mauerwerk verantwortlich.

Die Montage und das Verlegen der Elektroartikel sind nur von autorisiertem Fachpersonal durchzuführen. Beachten Sie die Beschreibungen und die Gewichtsangaben in der Montageanleitung.

Halten Sie bitte die angegebenen max. Gewichtsangaben ein. Bei Überlastungen, die durch spielende Kinder, Menschen, Material oder sonstige Einwirkungen entstehen -übernehmen wir als Möbelproduzent keine Haftung!

Die einwandfreie Funktion des Möbels ist nur bei lot- und waagerechter Aufstellung gewährleistet. Die Türen sind vorjustiert, müssen aber ggf. aufgrund örtlicher Bedingungen neu ausgerichtet / eingestellt werden!

Alle elektrischen Installationen sind nach den gültigen Normen bzw. Vorschriften von VDE, CE, MM gefertigt. Die zu verwendende Leuchtmittelstärke ist auf der jeweiligen Lampenfassung angegeben.

Bei Nichteinhaltung der max. Wattzahl besteht durch Überhitzung Brandgefahr. Das Zudecken der Leuchtmittel ist wegen Brandgefahr zu unterlassen!

Alle Schrauben sowie tragende Verbindungsstelle sollten nach 5 bis 6 Wochen nachgezogen werden, um eine dauerhafte Standsicherheit zu gewährleisten!

Keine scheuernden Putzmittel verwenden!

Werden Betriebs-, Bedienungs- oder Montageanweisungen nicht befolgt, Änderungen an den Produkten vorgenommen, Teile ausgewechselt oder Verbrauchsmaterialien verwendet, die nicht den Originalteilen entsprechen, so entfällt jegliche Gewährleistung oder Haftungsansprüche.

(GB) Dear Customer,

As a furniture manufacturer we would like to point out that an attachment is only as good as the connection between the attachment material (dowel) and masonry. In the case of suspension elements you should check your masonry and only use the appropriate dowels from a specialist store. Ultimately it is the person carrying out the installation who is responsible for attachment to the masonry.

The installation and laying of electrical lines and other items must only be performed by authorised specialists. Please note the descriptions and weight information in the installation instructions.

Please observe the stated maximum weights; in the case of mechanical overloads caused by playing children, other individuals, materials etc. we do not accept any liability as the manufacturer of the furniture!

The furniture is only guaranteed to work perfectly if it is set up to be plumb and horizontal. The doors have been pre-adjusted, but may need to be realigned/readjusted in accordance with local conditions!

All electrical installations have been produced in accordance with the latest norms and regulations, such as those of the VDE (Association of German Electrical Engineers), CE and MM. The power of the bulbs to be used is marked on the respective light fitting. If the maximum number of watts stated on the fitting is not complied with, there is a danger of fire from overheating. Covering the lamps and bulbs is strictly prohibited due to the danger of fire!

All screws and load-bearing connecting parts should be tightened after 5 to 6 weeks in order to ensure long-term stability!

Do not use any abrasive cleaning materials!

If the operating or installation instructions are not complied with, modifications are carried out to the products, parts replaced or consumable materials used which do not correspond to the original parts, all warranty or liability claims shall become null and void.

(CZ) Vážený zákazník,

jako výrobce nábytku bychom Vás chtěli informovat o tom, že upevnění je jen tak dobré, jak dobré je spojení mezi upevňovacím materiálem (hmoždinkou) a zdívkou. U závěsných prvků zkontrolujte příslušné zdivo a používejte jen vhodné hmoždinky, které nakoupíte v odborných obchodech. Za upevnění ve zdivu je nakonec zodpovědný ten, kdo upevnění montuje.

Montáž a instalaci elektrických částí směřj provádět jen pověřeni odborní pracovníci. Dodržujte popisy a údaje o hmotnosti uvedené v návodu k montáži.

Dodržujte uvedené údaje o maximální hmotnosti při přetížení, které je způsobeno hrajícími si dětmi, lidmi, materiálem nebo jinými vlivy, nepřebíráme jako výrobce nábytku záruku!

Bezvadná funkce nábytku je zaručena jen při postavení nábytku ve správné vodorovné poloze. Dvířka jsou předem nastavená, případně je ale nutné je znovu seřídít / nastavit podle místních podmínek!

Všechny elektrické instalace jsou provedeny podle platných norem příp. předpisů VDE (svaz německých elektrotechniků), CE, MM. Intenzita žárovky/zdroje světla, která se má použít, je uvedena na příslušné objímce žárovky/zdroje světla. Při nedodržení maximálního výkonu ve Wattch hrozí nebezpečí vznícení kvůli přehřátí. Zakrytí žárovky/zdroje světla je kvůli nebezpečí požáru zakázáno! Všechny šrouby a nosné spojovací prvky se mají po 5 až 6 týdnech dotáhnout, čímž se zajistí trvalá stabilita!

Nepoužívejte žádné abrazivní čisticí prostředky!

Pokud se nedodržují pokyny k provozu, návodu nebo montáži, provádějí se úpravy výrobků, vyměňují se díly za neoriginální nebo se používá spotřební materiál, který neodpovídá originálnímu, zaniká záruka nebo nároky plynoucí z odpovědnosti.

(HU) Tisztelt Ügyfelünk!

Mint bútorgyártó arról szeretnénk tájékoztatni Önt, hogy a rögzített szerkezetek minősége a rögzítő anyag (tipli) és a fal közti összeköttetés minőségétől függ. Falra szerelt egységek esetén ellenőrizze a fal adottságait és csakis szakkereskedelemből származó, a rögzítéshez megfelelő tipliket használjon. Végső soron a bútort felszerelő személy felelős a falra történő rögzítésért.

A villamossági cikkek szerelését és elhelyezését csakis erre jogosult szakember végezheti. Kérjük, vegye figyelembe az összeszerelési útmutatóban szereplő leírásokat és súlyadatokat.

Tartsa be a megadott maximális súlyhatárokat. A bútór játszó gyermekek, személyek, anyagok vagy egyéb behatások okozta túlterhelésért a bútorgyártót nem terheli felelősség.

A bútór kifogástalan működése csakis pontosan függőleges helyzetben garantált. Az ajtók előre be vannak állítva, a helyi adottságok függvényében azonban szükség esetén újra be kell állítani/igazítani őket.

A villamos berendezések a német VDE, CE és MM érvényes szabványainak és előírásainak megfelelően készültek. A világítótestek megfelelő erőssége az adott lámpa foglalátán található meg.

A max. watt-szám be nem tartása esetén túlforrósodás következtében fellépő tűzveszély áll fenn. A világítótesteket tűzveszély miatt nem szabad letakarni!

Minden csavart és tartó összekötő részt 5-6 hét elteltével újra meg kell húzni a bútór álló helyzetben való tartós biztonsága érdekében.

Nem használjon habzó tisztítószereket!

Az üzemeltetési, kezelési ill. szerelési útmutató utasításainak be nem tartása, a terméken végzett változtatások, részek kicserélése, vagy az eredeti részeknek meg nem felelő anyagokat felhasználása esetén mindennemű szavatosság és felelősség kizárt.

(SK) Vážený zákazník,

ako výrobca nábytku by sme Vás chceli informovať o tom, že nové upevnenie je len také dobré, aké dobré je spojenie medzi spojovacím materiálom (hmoždinka) a murivom. Pri visiачích elementoch skontrolujte Vaše murivo a použite na príslušné murivo iba určenú hmoždinku zo stavebnín. V konečnom dôsledku je za upevnenie na murive zodpovedný montér.

Montáž a pokládka elektrických materiálov a spotrebičov smie vykonávať iba autorizovaný odborný personál. Prosíme, dodržte popisy a údaje o hmotnosti v návode na montáž.

Dodržiavajte uvádzané údaje o maximálnej hmotnosti pri preťažení, ktoré môžu spôsobiť hrajuce sa deti, ľudia, materiál, alebo iné vplyvy - my, ako výrobca nábytku nepreberáme žiadne ručenie!

Bezchybná funkcia nábytku je zaručená iba pri kolmome a vodorovnom postavení. Dvere sú vopred nastavené, v prípade potreby na základe miestnych podmienok je však nutné ich znovu vyvážiť/nastaviť!

Všetky elektrické inštalácie sú zhotovené podľa platných noriem, resp. predpisov VDE, CE, MM. Sila osvetľovacích telies, ktoré sa majú použiť, je uvedená na objímkach príslušných žiaroviek.

Pri nedodržaní maximálnych Wattov vzniká na základe prehriatia riziko požiaru. Neprikrývajte osvetľovacie telesá kvôli riziku požiaru!

Všetky skrutky, ako aj nosné spojovacie diely by sa mali po 5 až 6 týždňoch dotiahnuť, aby bola zaručená trvalá stabilita!

Nepoužívejte žádné drsné čistiace prostředky!

Ak nebudú dodržané prevádzkové návody, návody na obsluhu alebo montáž, ak sa budú na produktoch vykonávať zmeny, vymieňať diely alebo ak sa bude používať spotrebný materiál, ktorý nezodpovedá originálnym dielom, odpadá akákoľvek záruka alebo akékoľvek nároky na ručenie.

(HR) Spo.tovani,

kot proizvajalec pohi.tva vas .elimo informirati, da je pritrđitev samo tako mo.na, kot je mo.na povezava med pritrđilnim materialom (moznikom) in zidom. Pri elementih, ki so obe.eni, preverite zid in uporabite samo za zidove primerne moznike, ki ste jih nabavili v strokovni trgovini. Nenazadnje odgovarja monter za pritrđitev. Elektriki.ne artikle naj vam polo.i in montira strokovnjak. Pri tem upo.tevajte opise ter podatke o te.i v navodilih za monta.o.

Upo.tevajte podano maksimalno te.o - pri previsokih obremenitvah, ki nastanejo zaradi igranja otrok, bremen ljudi ali drugega materiala ali zaradi drugih obremenitev . kot proizvajalec pohi.tva ne prevzemamo nikakr.ne odgovornosti!

Pravilno delovanje funkcij pohi.tva je zagotovljeno samo pri pravilni vodoravni in pravokotni postavitvi. Vrata so predhodno justirana, vendar jih je treba zaradi lokalnih pogojev na novo nastaviti!

Vse elektriki.ne instalacije so izdelane v skladu z veljavnimi standardi oz. predpisi VDE, CE in MM. Jakost uporabljenih .arnic je vedno navedena na vsakem posameznem okviru za svetilo.

Pri neupo.tevanju maks. .tevila vatov obstaja zaradi pregretja nevarnost po.ara. Svetil zaradi nevarnosti po.ara ni dopustno prekrivati!

Vse vijake in nosilne povezovalne dele po 5 do 6 tednih naknadno privija.ite, da boste zagotovili stalno trdnost povezav!

Ne uporabljajte .istil za drgnjenje!

V primeru neupo.tevanja navodil za delovanje, uporabo in monta.o, in v primeru izvajanja sprememb na produktih ter menjave delov ali porabnega materiala, ki ne ustrezajo originalnim delom, izgubi kupec vse pravice do uveljavljanja garancije.

(I) Gentile cliente,

in qualità di produttori di mobili desideriamo informarla del fatto che un fissaggio può essere solo veramente buono se anche il collegamento tra il materiale di fissaggio (bullone) e le mura è altrettanto buono. Nel caso degli elementi che pendono controllate le vostre mura ed utilizzate solamente bulloni previsti a tale scopo che troverete in un mercato specializzato. Infine è il montatore ad essere responsabile per il fissaggio sulla parete.

Il montaggio e la messa in funzione degli apparecchi elettronici devono essere effettuati esclusivamente da parte di personale specializzato. Si prega di rispettare le descrizioni e le indicazioni relative al peso presenti nelle istruzioni per il montaggio.

Si prega di rispettare le indicazioni relative al peso massimo - nel caso di un sovraccarico che può essere causato da bambini che giocano, da persone, da materiale oppure da altri infussi si declina qualsiasi responsabilità!

Il funzionamento corretto del mobile è garantito solamente in caso di un montaggio corretto in posizione orizzontale e come riportato sull'imballaggio. Le porte sono già state anticipate pre-impostate, essere dovranno però, qualora necessario, essere adattate / regolate conformemente alle nuove condizioni ambientali!

Tutte le installazioni elettriche sono preparate secondo le norme e le regole vigenti VDE, CE, MM. La potenza dei mezzi d'illuminazione da utilizzarsi è riportata sul rispettivo zoccolo della lampada.

In caso di mancato rispetto del numero massimo di Watt può verificarsi un surriscaldamento con il pericolo d'incendio. È vietato coprire i mezzi d'illuminazione perché sussiste pericolo d'incendio!

Tutte le viti e gli elementi portanti di collegamento dovrebbero essere ri-aggiustati dopo 5 o 6 settimane al fine di garantire un funzionamento sicuro continuativo!

Non utilizzare mezzi di pulizia che creino polvere di pulizia!

In caso di mancato rispetto delle indicazioni per l'esercizio, il comando o il montaggio, nel caso in cui venissero effettuate delle modifiche ai prodotti, in cui venissero sostituiti degli elementi oppure in cui venissero utilizzati dei materiali ausiliari che non corrispondono ai pezzi originali, allora non sarà più esigibile nessuna garanzia o nessuna richiesta di garanzia.

(NL) Geachte klant,

Als meubelproducent willen wij u erover informeren dat een bevestiging slechts zo goed is als de verbinding tussen het bevestigingsmateriaal (plug) en de muur. Controleer daarom bij aan de muur hangende elementen uw muurconstructie en gebruik alleen hiervoor geschikte pluggen uit een speciaalzaak. Tenslotte is de monteur verantwoordelijk voor de bevestiging aan de muur.

De montage en het leggen van kabels van elektrische artikelen mag uitsluitend door hiervoor bevoegd vakpersoneel worden uitgevoerd. Houd ook rekening met de beschrijvingen en de vermelde gewichten in de montagehandleiding.

Neem de aangegeven maximumgewichten in acht. Bij overbelasting die door spelende kinderen, personen, materiaal of overige invloeden ontstaat, zijn wij als meubelproducent niet aansprakelijk!

Het onberispelijk functioneren van het meubel is alleen gegarandeerd, wanneer dit horizontaal en verticaal waterpas wordt opgesteld. De deuren zijn vooraf ingesteld, monteaal echter eventueel door de omstandigheden ter plaatse opnieuw worden afgesteld / ingesteld!

Alle elektrische aansluitingen voldoen aan de geldende normen resp. voorschriften van VDE, CE, MM. Het te gebruiken lampwattage is aangegeven op de betreffende lampfitting.

Wanneer het maximaal geoorloofde wattage niet wordt aangehouden, bestaat brandgevaar door oververhitting. Het afdekken van de lamp is in verband met brandgevaar verboden!

Alle schroeven en dragende verbindingselementen moeten na 5 à 6 weken worden aangedraaid om een duurzame stabiliteit te waarborgen!

Gebruik geen schurende schoonmaakmiddelen!

Wanneer gebruiksvorschriften, bedienings- of montage-instructies niet worden opgevolgd veranderingen aan de producten worden uitgevoerd, onderdelen worden vervangen of verbruiksmaterialen gebruikt, die niet overeenkomen met de originele onderdelen, vervalt iedere garantie of aansprakelijkheid.

(BG) Многоуважаеми клиенти,

като производител на мебели, ние желяем да Ви информираме, че дадено закрепване е само толкова добро, колкото връзката между закрепващото средство (дюбел) и зидарията. При висящи (окачени) елементи проверявайте Вашата зидария и използвайте само предвидени за целта дюбели от специализирани магазини. В края на краищата, монтьорът е отговорен за закрепването на зидарията.

Монтажът и полагането на електрически части трябва да се извършва само от оторизирани специалисти. Съблюдавайте описанията и данните за теглото в инструкцията за монтаж. Спазвайте указаните макс. данни за тегло – като производител на мебели, ние не поемаме отговорност при претоварване, причинено чрез играещи деца, хора, материали или други влияния!

Безупречното действие на мебелите се гарантира само при вертикален и хоризонтален монтаж. Вратите са предварително юстирани, но при необходимост поради локалните условия трябва да се изравняват / регулират!

Всички електрически инсталации са произведени съгласно валидните норми, съотв. разпоредби на VDE, CE, MM. Силата на осветителните тела, която трябва да се използва е указана на съответната фасунга на лампата.

При непродържане към макс. мощност съществува опасност от пожар чрез прегряване. Поради опасност от пожар не трябва да се извършва покриване на осветителното тяло!

За гарантиране на продължителна стабилност, всички болтове, както и носещи свързващи части трябва да се затегнат допълнително след 5 до 6 седмици!

Не използвайте триещи почистващи средства!

Ако инструкциите за експлоатация, обслужване или монтаж не се съблюдават, ако се извършат промени на продуктите, ако се подменят части или се използват консумативи, които не отговарят на оригиналните части, в този случай отпада всякаква отговорност или гаранционни права.

(F) Cher client,

En tant que fabricant de meubles, nous souhaitons attirer votre attention sur le fait que la meilleure des fixations n'est rien sans la qualité du raccord entre le matériel de fixation (cheville) et la maçonnerie. Par conséquent, pensez à vérifier la maçonnerie avant d'accrocher les éléments hauts et utilisez uniquement les chevilles prévues à cette fin, achetées dans une grande surface spécialisée. En fin de compte, c'est l'installateur qui sera responsable de la fixation à la maçonnerie.

Le montage et la pose des articles d'électroménager sont strictement l'affaire d'un personnel qualifié, dûment habilité. Veuillez observer les descriptions et les poids indiqués dans la notice de montage.

Veuillez respecter les poids maxi spécifiés ; en tant que fabricant de meubles, nous déclinons toute responsabilité en cas de surcharges causées par des enfants qui jouent, d'autres personnes, du matériel divers ou provoquées par d'autres influences !

Pour assurer le fonctionnement irréprochable du meuble, il faut veiller à l'installer parfaitement d'aplomb et à l'horizontale. Les portes sont préajustées, mais il sera peut-être nécessaire de les réaligner/régler à nouveau sur place !

Toutes les installations électriques sont fabriquées selon les normes et prescriptions VDE, CE, MM en vigueur. La puissance à utiliser est précisée sur la douille de chaque lampe.

Si le wattage max. n'est pas respecté, il existe un risque d'incendie dû à la surchauffe. Il est interdit de recouvrir la lampe, en raison du risque d'incendie ! Il faut resserrer toutes les vis et les éléments de raccord porteurs après 5 à 6 semaines, pour assurer une stabilité durable !

N'employez en aucun cas des nettoyeurs abrasifs !

Si les instructions de service, de commande ou de montage ne sont pas respectées, si des modifications sont apportées aux produits ou bien encore si des pièces sont remplacées ou si des consommables qui ne correspondent pas aux pièces d'origine sont utilisés, nous n'assurons alors aucune garantie et nous déclinons toute responsabilité dans ces cas.

(PL) Szanowni Klienci!

Jako producent mebli pragniemy Państwu przypomnieć, że umocowanie mebli jest tak dobre, jak dobre jest połączenie pomiędzy materiałem mocującym (kołkiem rozporowym) a ścianą. Proszę zatem w przypadku elementów wiszących sprawdzić wytrzymałość muru i użyć do ich zamocowania wyłącznie przeznaczonych do tego kołków ze sklepu specjalistycznego. Ostateczną odpowiedzialność za przymocowanie do ściany ponosi monter mebli.

Montaż artykułów elektrycznych i ich ułożenie należy powierzyć wyłącznie autoryzowanemu personelowi. Proszę zastosować się do opisów oraz ciężarów podanych w instrukcji montażu.

Proszę przestrzegać podanych ciężarów maksymalnych. W przypadku nadmiernego obciążenia, powstałego w wyniku bawiących się dzieci, osób, materiału lub z innych powodów jako producent mebli nie ponosimy odpowiedzialności!

Nienaganne funkcjonowanie mebla jest zagwarantowane wyłącznie w przypadku jego prawidłowego pionowego i poziomego ustawienia. Drzwi zostały odpowiednio ustawione, ale ze względu na warunki lokalne należy je ewentualnie ustawić na nowo/wyregulować!

Wszystkie instalacje elektryczne wykonano zgodnie z obowiązującymi normami lub przepisami VDE, CE, MM. Na każdej oprawce lampowej podana jest moc żarówek, których należy używać.

W przypadku nieprzestrzegania maksymalnej ilości watów istnieje niebezpieczeństwo pożaru w wyniku przegrzania. Żarówek nie wolno przykrywać ze względu na niebezpieczeństwo pożaru!

Dla zapewnienia trwałej stateczności po 5-6 tygodniach należy dokręcić wszystkie śruby i nośne elementy łączące!

Nie używać żadnych środków czyszczących wymagających szorowania!

W przypadku nieprzestrzegania instrukcji użytkowania, obsługi i montażu, dokonywania zmian w produktach, wymiany części lub używania materiałów zużywających się, które nie odpowiadają częściom oryginalnym, wyklucza się jakąkolwiek gwarancję lub roszczenia z tytułu odpowiedzialności cywilnej.

(SLO) Cijenjeni kupče,

kao proizvođač namještaja želimo Vas informirati o tome da učvršćenje drži ukoliko je dobar spoj između materijala za pričvršćenje (moždanik) i zida. Kod višćih elemenata ispitajte zide i koristite samo moždanike predviđene za to iz specializirane stručne trgovine. Najzad, monter je odgovoran za učvršćenje na zidu.

Montažu i položenje elektro-artikala može izvršavati samo autorizirano stručno osoblje. Pazite na opise i podatke o težini u uputstvu za montažu.

Pridržavajte se navedenih podataka o maksimalnoj težini u slučaju preopterećenja izazvanih zbog djece koja se igraju, ljudi, materijala ili drugih utjecaja kao proizvođač namještaja ne preuzimamo garanciju!

Besprijeckorna funkcija namještaja je zajamčena samo kod vertikalne i vodoravne montaže. Vrata su prednamještana, ali u danom slučaju se moraju nanovo centrirati / podesiti, na osnovi lokalnih uvjeta!

Sve električne instalacije su izvedene prema vrjedecim VDE-, CE-, MM-normama odnosno -propisima. Jačina rasvjetnog sredstva koju treba koristiti, navedena je na dotičnom grlu žarulje.

U slučaju nepridržavanja maksimalne vataže, postoji opasnost od požara zbog pregrijavanja. Ne smije se pokriti rasvjetno sredstvo zbog opasnosti od požara! Sve vijke kao i noseće spojne dijelove treba naknadno pritegnuti poslije 5 do 6 tjedana da bi tako bila zajamčena trajna stabilnost!

Nemojte koristiti ribajuća sredstva za čišćenje!

Ukoliko se na pridržavate pogonskoj uputi, uputi za rad ili za montažu, ako vršite promjene na proizvodima, izmijenite dijelove ili koristite potrošne materijale koji ne odgovaraju originalnim dijelovima, otpada svaka garancija i svaki zahtjev za jamčenjem.

IT

Consigli di manutenzione per facciate lucide di mobili

Attenzione!

Al momento della consegna, le nostre brillanti superfici sono protette da una pellicola. Lasciarla sul mobile finché non sarà completamente montato e spolverato. Per conservare il pregiato aspetto brillante, osservare i seguenti consigli:

consentire alla pellicola lucida di adattarsi per un'ora al clima dell'ambiente dopo aver tolto la pellicola protettiva, pulire le superfici usando solo un panno di cotone umido e un po' di detergente per vetri. Non utilizzare detergenti aggressivi con additivi. Pulire le superfici passando uno strofinaccio bagnato con una leggera frizione. Non utilizzare pulitori a vapore. Non danneggiare la superficie con oggetti taglienti. Non esporre in nessun caso le superfici a forti radiazioni solari

Con l'augurio che i vostri nuovi mobili possano darvi tante soddisfazioni!

Area Sviluppato prodotti

Instrucțiuni de întreținere pentru fețe lucioase de mo- bilie

RO

IT

Attention Remarque !

Nos surfaces haute brillance sont protégées à la livraison par un film protecteur. Veuillez le laisser sur le meuble jusqu'à ce qu'il soit entièrement installé et que la poussière soit supprimée.

Pour obtenir un aspect de qualité et de haute brillance, vous devez

laisser durcir pendant une heure à l'air ambiant le film haute brillance après avoir enlevé le film protecteur pour le nettoyage des surfaces, utiliser uniquement un chiffon de coton humide et un peu de lave-vitre.

Ne pas utiliser de détergent agressif comportant des addi- tifs.

Frôler les surfaces avec un chiffon humide.

Ne pas utiliser de nettoyeur à vapeur.

ne pas endommager la surface avec des objets coupants ne pas soumettre les surfaces à un fort rayonnement solaire

Nous souhaitons que votre nouveau meuble vous donne entière satisfaction.

Voire service de développement de produits

FR

RO

Atenție indicație!

Suprafețele noastre lucioase sunt protejate la livrare cu o folie de protecție. Păstrați-o pe mobilier până la realizarea completă a montajului, respectiv până când nu se mai degajă praf.

Pentru a menține aspectul unic de luciu intens, trebuie s

după îndepărtarea foliei de protecție, asigurați aerisirea foliei lucioase pentru călăra timp de o oră,

utilizați pentru curățarea suprafețelor exclusiv o cârpă din bambac umezită și puțină soluție de curățat sicla.

nu utilizați detergenți corosivi cu aditivi,

ștergeți suprafețele cu o cârpă umeză,

nu utilizați dispozitive de curățat cu abur.

Nu deteriorați suprafețele cu obiecte ascuțite

Nu expuneți în niciun caz suprafețele la radiații solare intense

Vă dorim multe satisfacții la utilizarea noului dvs. mobilier.

Departamentul dvs. de creație produse

IT

Consigli di manutenzione per facciate lucide di mobili

FR

Consigne d'entretien pour les faces de meubles de haute brillance

RO

Instrucțiuni de întreținere pentru fețe lucioase de mo- bilie

IT

Attenzione!

Al momento della consegna, le nostre brillanti superfici sono protette da una pellicola. Lasciarla sul mobile finché non sarà completamente montato e spolverato. Per conservare il pregiato aspetto brillante, osservare i seguenti consigli:

consentire alla pellicola lucida di adattarsi per un'ora al clima dell'ambiente dopo aver tolto la pellicola protettiva, pulire le superfici usando solo un panno di cotone umido e un po' di detergente per vetri. Non utilizzare detergenti aggressivi con additivi. Pulire le superfici passando uno strofinaccio bagnato con una leggera frizione. Non utilizzare pulitori a vapore. Non danneggiare la superficie con oggetti taglienti. Non esporre in nessun caso le superfici a forti radiazioni solari

Con l'augurio che i vostri nuovi mobili possano darvi tante soddisfazioni!

Area Sviluppato prodotti

Instrucțiuni de întreținere pentru fețe lucioase de mo- bilie

FR

Attention Remarque !

Nos surfaces haute brillance sont protégées à la livraison par un film protecteur. Veuillez le laisser sur le meuble jusqu'à ce qu'il soit entièrement installé et que la poussière soit supprimée.

Pour obtenir un aspect de qualité et de haute brillance, vous devez

laisser durcir pendant une heure à l'air ambiant le film haute brillance après avoir enlevé le film protecteur pour le nettoyage des surfaces, utiliser uniquement un chiffon de coton humide et un peu de lave-vitre.

Ne pas utiliser de détergent agressif comportant des addi- tifs.

Frôler les surfaces avec un chiffon humide.

Ne pas utiliser de nettoyeur à vapeur.

ne pas endommager la surface avec des objets coupants ne pas soumettre les surfaces à un fort rayonnement solaire

Nous souhaitons que votre nouveau meuble vous donne entière satisfaction.

Voire service de développement de produits

RO

Atenție indicație!

Suprafețele noastre lucioase sunt protejate la livrare cu o folie de protecție. Păstrați-o pe mobilier până la realizarea completă a montajului, respectiv până când nu se mai degajă praf.

Pentru a menține aspectul unic de luciu intens, trebuie s

după îndepărtarea foliei de protecție, asigurați aerisirea foliei lucioase pentru călăra timp de o oră,

utilizați pentru curățarea suprafețelor exclusiv o cârpă din bambac umezită și puțină soluție de curățat sicla.

nu utilizați detergenți corosivi cu aditivi,

ștergeți suprafețele cu o cârpă umeză,

nu utilizați dispozitive de curățat cu abur.

Nu deteriorați suprafețele cu obiecte ascuțite

Nu expuneți în niciun caz suprafețele la radiații solare intense

Vă dorim multe satisfacții la utilizarea noului dvs. mobilier.

Departamentul dvs. de creație produse

HU

Pokyn pre ošetrovanie leštených čelých ploch ná- bytku

SK

Leštené plochy sú pri dodaní chránené ochrannou fóliou. Túto fóliu neodstraňujte skôr, ako nábytok zmontujete a zbavíte prachu. Aby ste zachovali vzhľad lešteného povrchu, mali by ste leštenú fóliu po odstránení ochrannej fólie nechať na vzduchu približne jednu hodinu zatvrdnúť. pre čistenie povrchu používať len vlhkú bavlnenú utierku a malé množstvo umývacieho prostriedku na skla. Nepoužívajte žiadny ostrý čistiaci prostriedok s prídavnými látkami. Povrchy vydrhnite mokrú handrou. Nepoužívajte parný čistič. Povrchy nepoškodzujte ostrými predmetmi. Povrchy v žiadnom prípade nevystavujte silnému slnečnému žiareniu.

Informace pro péči o nábytková čela s vysokým leskem

CZ

CZ

Pozor upozornění!

Naše povrchy s vysokým leskem jsou při dodání chráněny ochrannou fólií. Ponechte ji na nábytku, dokud nebude kompletně smontovaný a nebude z něho odstraněný prach.

Aby se zachovala cenná optika vysokého lesku, měli byste:

dát vysoce lesklé fólii po odstránění ochranné fólie hodinu čas na vyvržení na pokojovém vzduchu,

pro čištění povrchu používejte pouze vlhký bavlněný hadřík a trochu čisticího prostředku na skla.

nepoužívejte ostrý čističí prostředek s přísadami,

povrchy otřetejte mokrým hadrem,

nepoužívejte parní čistič.

nepoškodte povrch ostrými předměty

povrchy v žádném případě nevystavujte silnému slunečnímu žárění!

Přejeme Vám hodně radosti s Vaším novým nábytkem.

Vaše oddělení vývoje nových výrobků

HU

Figyelem, olvassa el a tanácsot!

A fényes felületeket a kiszállítás során védőfóliával védjük. Hagyja a fóliát a bútoron addig, amíg azt teljesen össze nem szerelte és nem távolította el róla a porrt.

Az értékes fényes felület megóvásához tegye a következőket:

Hagyja a fényes fóliát a védőfólia eltávolítása után egy órát keményedni a helyiség levegőjében.

A felületek tisztításához kizárólag nedves pamutkendőt és egy kevés ablaktisztítót használjon.

Ne használjon éles szemmecses tisztítószereket.

A felületet törölje át egy nedves ronggyal.

Ne használjon gőzölős tisztítóeszközt.

A felületet óvja a kemény tárgyakkal való sérüléstől.

A felület mindig óvni kell az erős napsütéstől.

Reméljük, sok örömet lel az új bútor használatában.

A termékfejlesztők

HU

Ápolási tanácsok a bútorok fényes homlokzati felületei- hez

HR

Uputa za održavanje
fronte namještaja visokog
sijaja

HR

Pozor uputa!

Naše površine visokog sjaja zaštićene su tijekom isporuke zaštitnom folijom. Ostavite ovu na namještaju, dok nije u cijelosti montiran i oslobođen od prašine.
Da biste dobili vrijednu optiku visokog sjaja, trebali biste ostaviti foliju visokog sjaja, nakon uklanjanja zaštitne folije, sat vremena na sobnom zraku radi naknadnog otvrdnjavanja; koristiti vlažnu pamučnu krpu i nešto sredstva za čišćenje stakla za čišćenje površina.
ne koristiti oštre deterdžente s dodacima,
obrisati površine s mokrom krpom,
ne koristiti parni čistač,
ne oštetiti površinu oštrim predmetima;
ne izlagati površine ni pod kojim okolnostima jakom sunčanom ozračavanju.

Želimo Vam puno srećnih trenutaka sa svojim novim amještajem.

Vaš razvoj proizvoda

Consejo de cuidado para
muebles con acabado de
alto brillo

ES

SV

Observera följande instruktioner!

Vid leveransen är våra höglansytor skyddade med en skyddsfolie. Låt denna vara kvar på möbeln tills den har monterats fullständigt och befriats från damm.
För att bibehålla det värdefulla höglansutseendet bör du tänka på följande:
Ge höglansfolien en timmes tid att efterhärda i rumsluften efter det att skyddsfolien har tagits bort.
Använd endast en fuktig bomullstrasa med lite glasrengöringsmedel för att rengöra yorna.
Använd inga skarpa rengöringsmedel med tillsatser.
Torka av yorna med en fuktig trasa.
Använd ingen ångrengörare.
Skada inte ytan med vaassa föremål.
Utsätt yorna under inga omständigheter för stark solstrålning.

Vi önskar dig mycket glädje med din nya möbel.

Din produktutveckling

BG

Указания за поддръжка
на гланцови
повърхности на мебели

BG

SL

Pozor, napotek!

Naše visokosijajne površine so pri dobavi zaščitene s folijo. Pustite jo na pohištvu, dokler ni v celoti montirano ter ga tako zaščitite pred prahom.
Da bi obdržali dragocen izgled visokega sijaja, morate visokosijajno folijo po odstranitvi zaščitne folije eno uro dati na sobno temperaturo, da se sirdi
za čiščenje površin uporabljajte samo vlažno bombažno krpo in malo čistila za steklo
Ne uporabljajte ostrih čistil z dodatki.
Površine zdrignite z mokro krpo
ne uporabljajte parnega čistilnika.
Ne poškodujte površine z ostrimi predmeti
V nobenem primeru ne izpostavljajte površin močnim sončnim žarkom

Želimo vam še mnogo veselja z vašim novim pohištvom.

Vaš razvojni oddelek

SL

Napotek za nego visokosijajnih
front

SL

ES

¡Atención!

Nuestras superficies con acabados de alto brillo están protegidas por una lámina protectora durante la distribución. Déjala sobre el mueble hasta que haya sido completamente montado y se haya limpiado el polvo.

Para conservar el aspecto brillante, haga lo siguiente:
aíree la lámina de alto brillo tras retirar la película protectora durante una hora
use solo un paño de algodón húmedo y un poco de limpiacris tales para limpiar las superficies
No use ningún producto de limpieza agresivo con principios activos.

Frote las superficies con un trapo húmedo.

No use vaporeta.

No dañe las superficies con objetos cortantes

No exponga las superficies en ningún caso a la luz del sol

Directa

Le deseamos que disfrute de su nuevo mueble.

El desarrollo de su producto

1

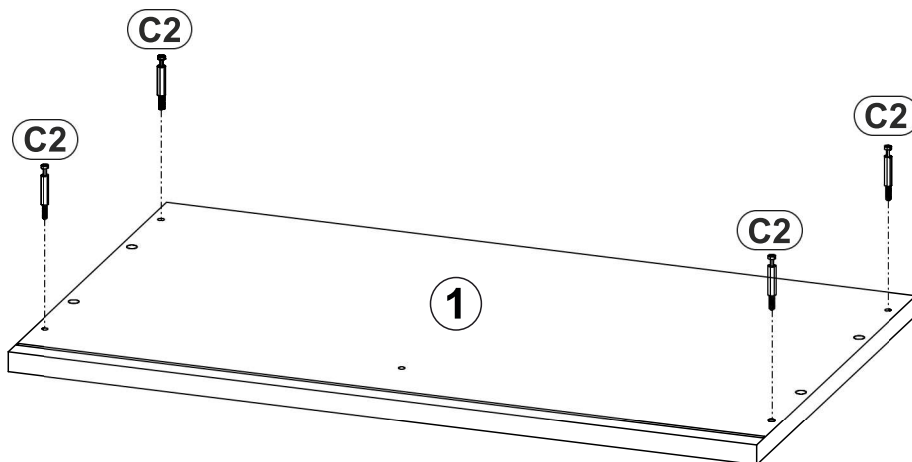
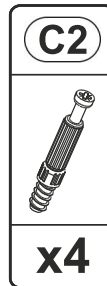
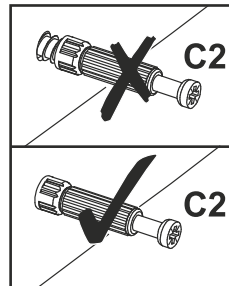
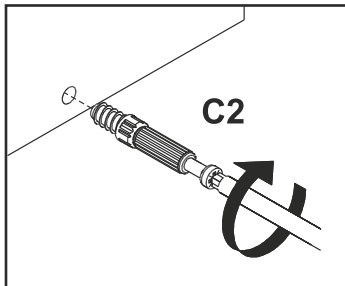



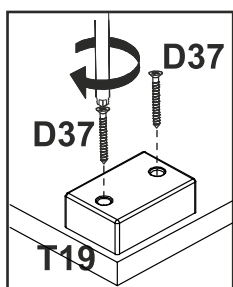
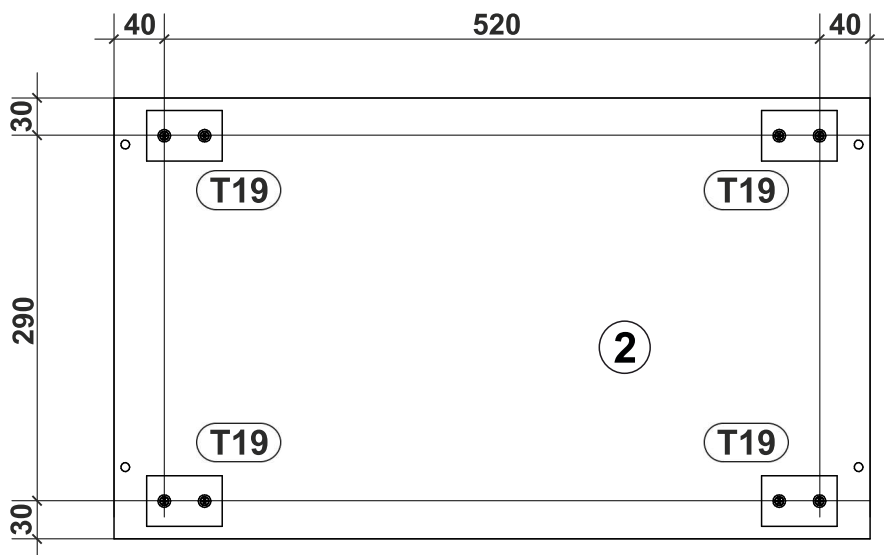
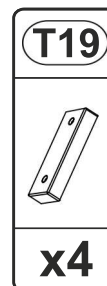
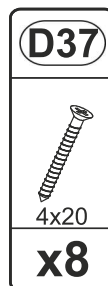
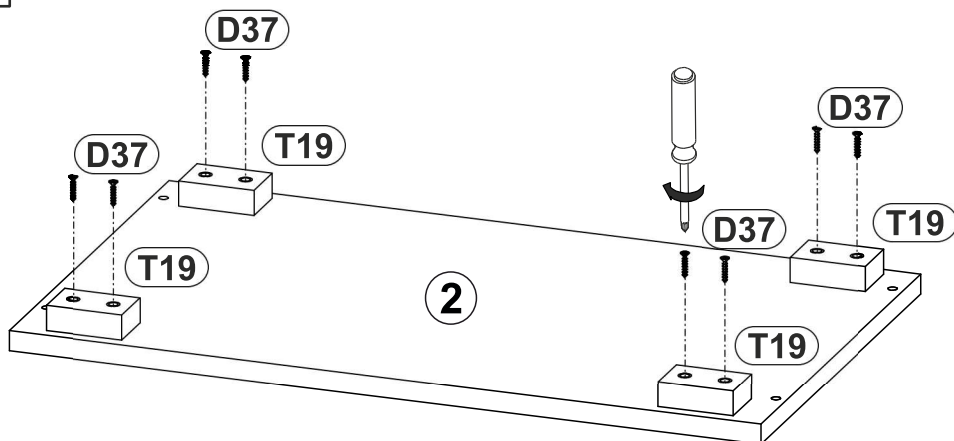

2

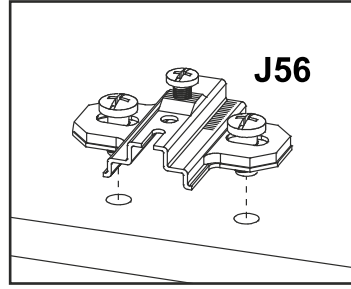

3





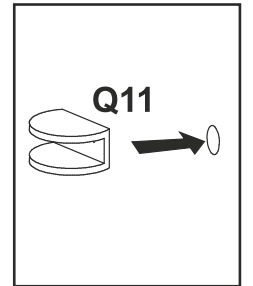
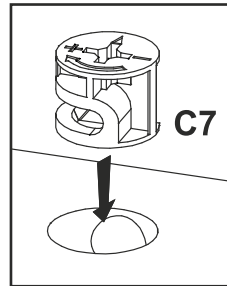
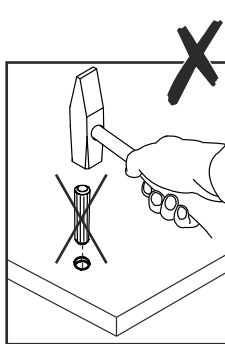
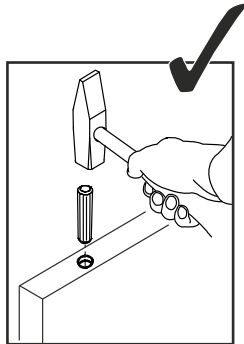
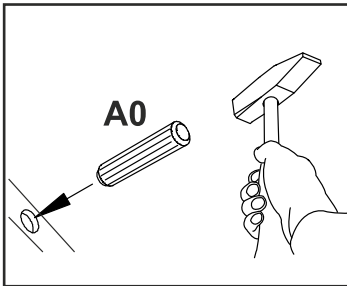
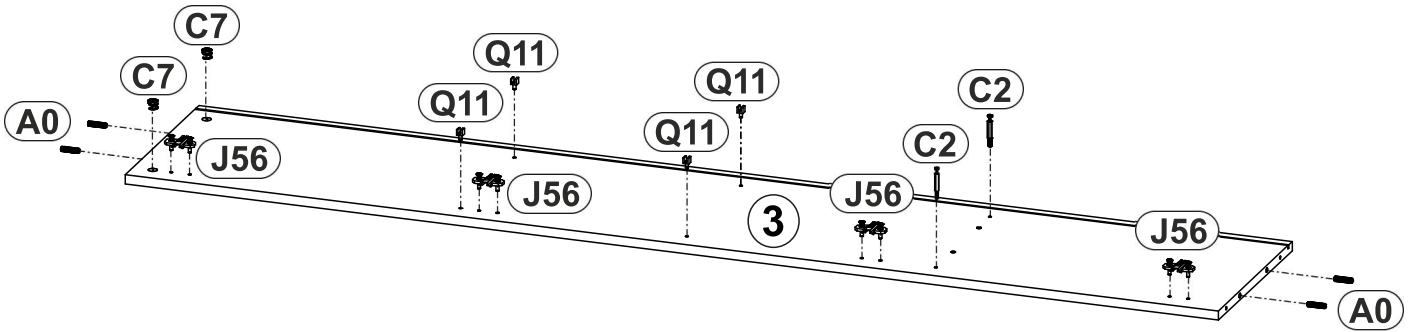

A0	C2	C7	J56	Q11
				
Ø8x30		16 mm		
x4	x2	x2	x4	x4

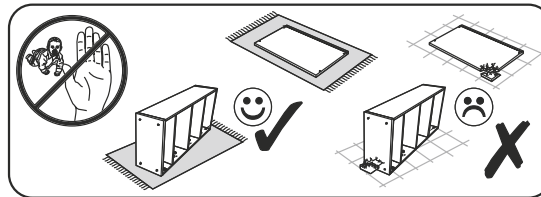

4





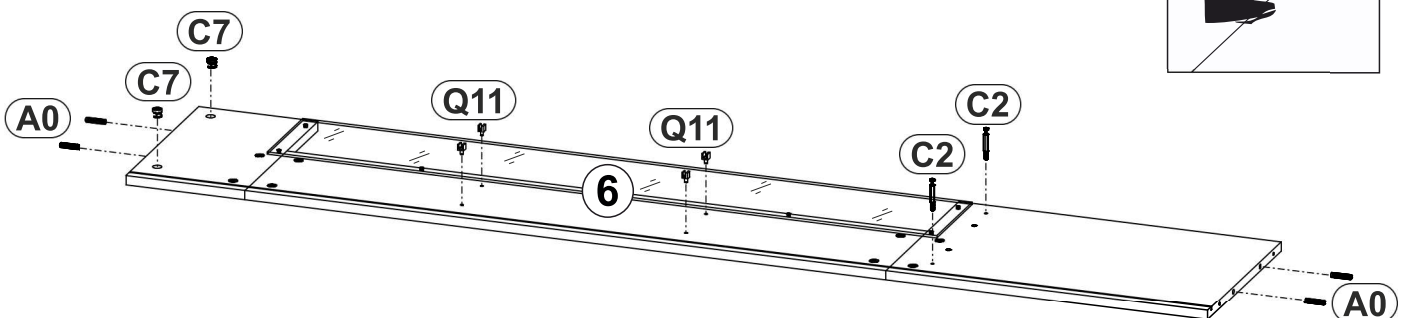
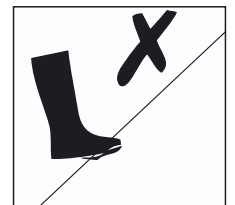



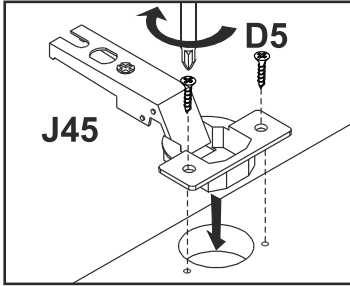

A0	C2	C7	Q11
			
Ø8x30		16 mm	
x4	x2	x2	x4



5



A0  Ø8x30 x4	C7  16 mm x4	D5  3.5x16 x8	H7  4x10 x2	J45  x4	L54  x1	U0  x3	U1  x2
--	--	---	---	--	--	---	---

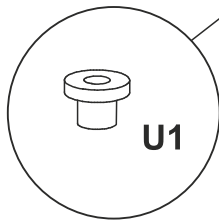
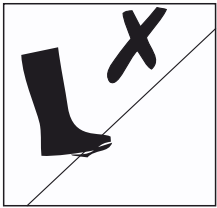
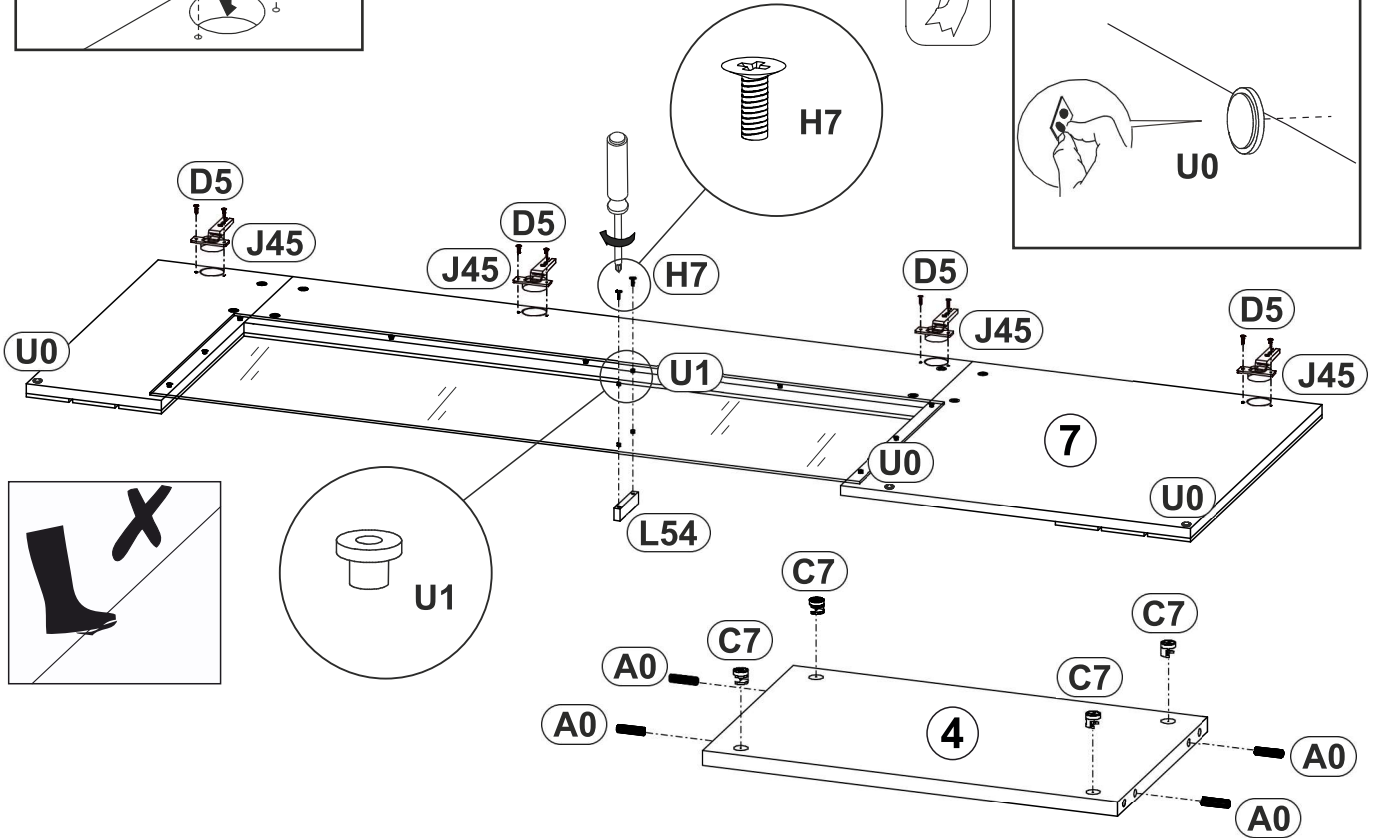
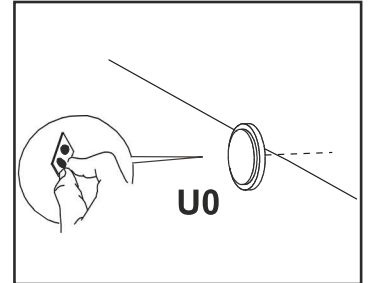

6

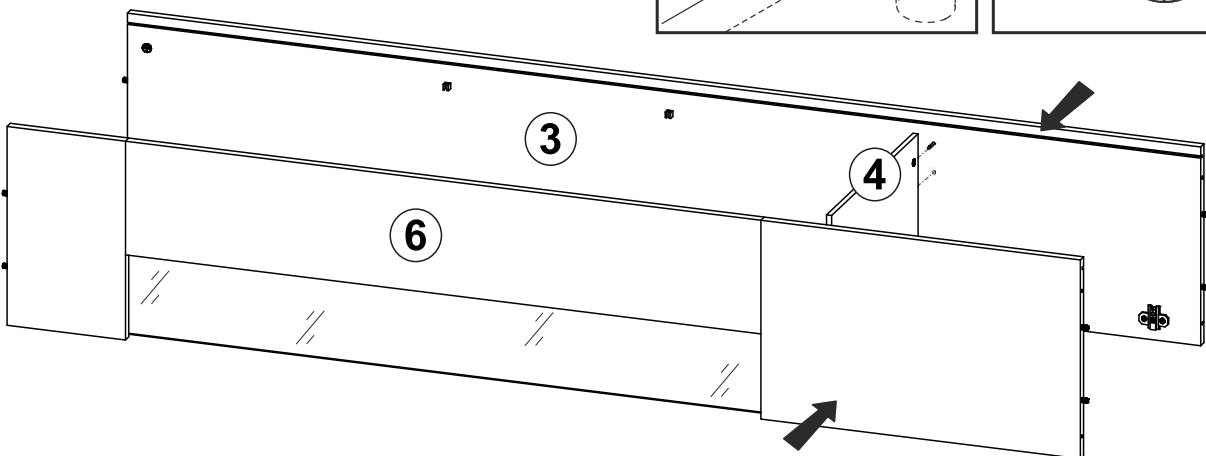
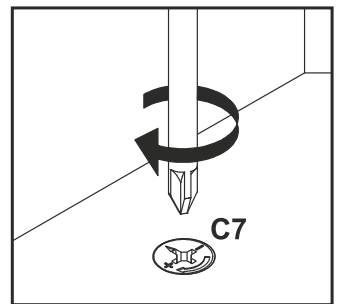
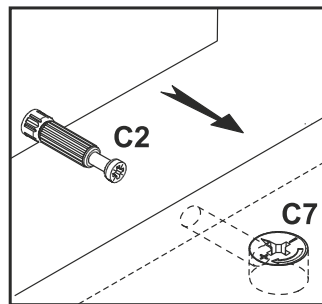

7

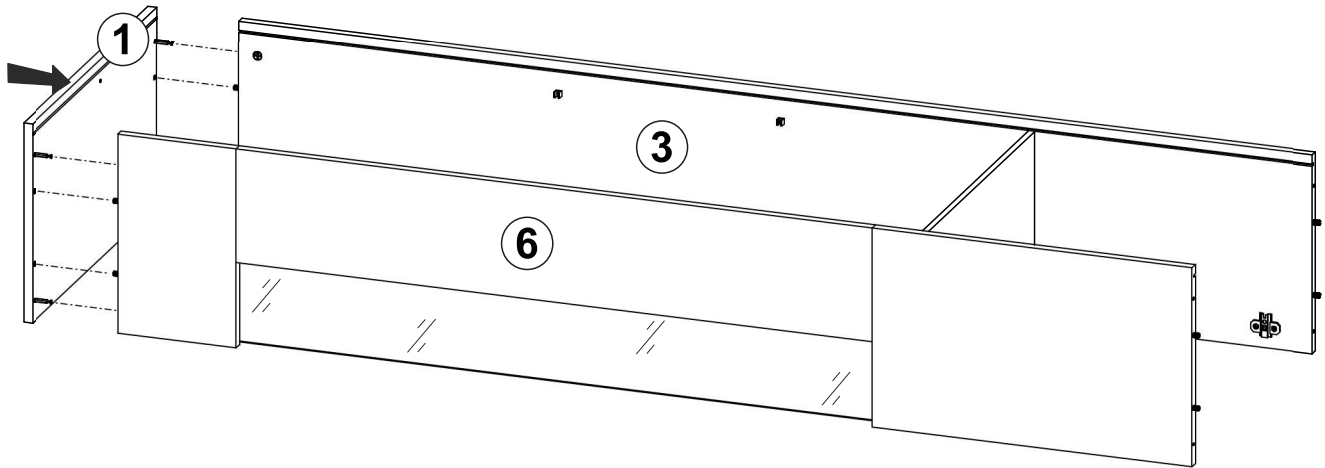
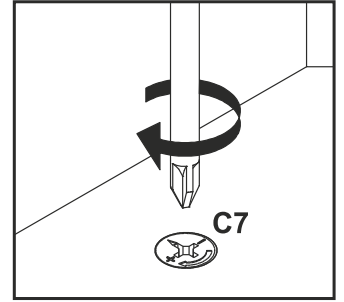
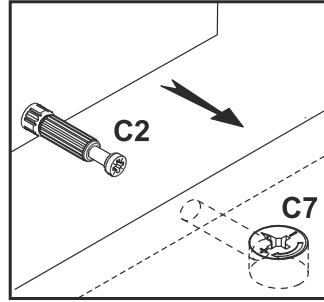

8

B0	B1	K
x4	$\text{\O}7 \times 50$ x4	4mm x1

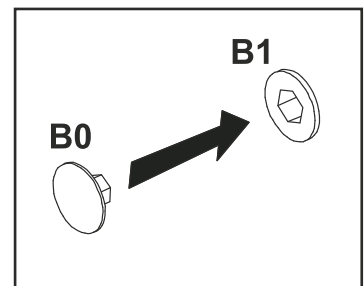
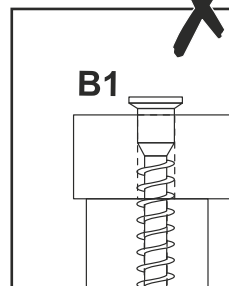
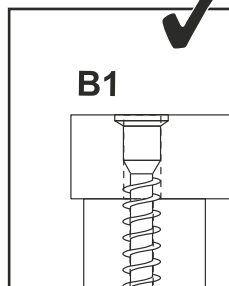
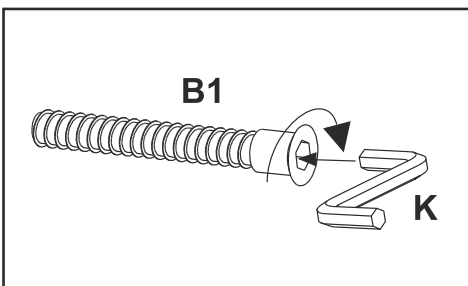
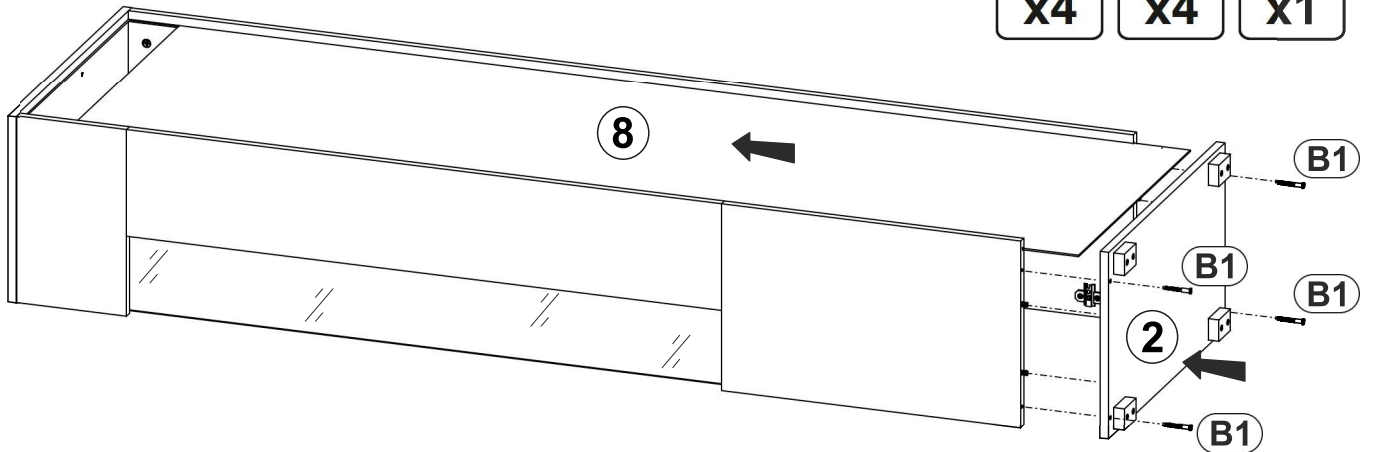

9

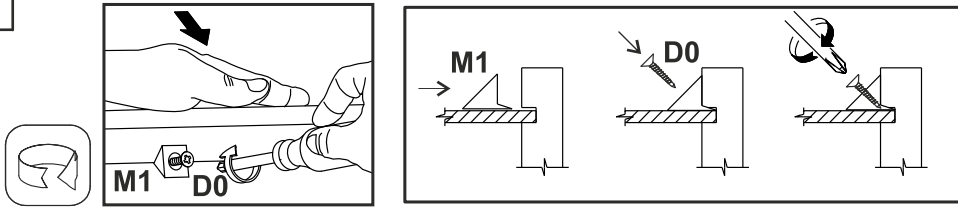

D0	M1
3x15	
x20	x20

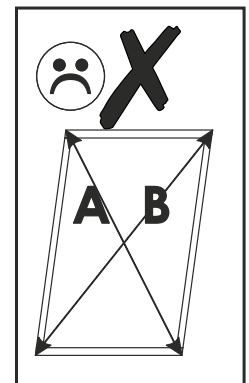
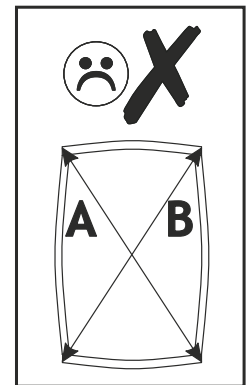
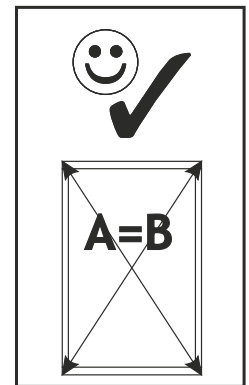
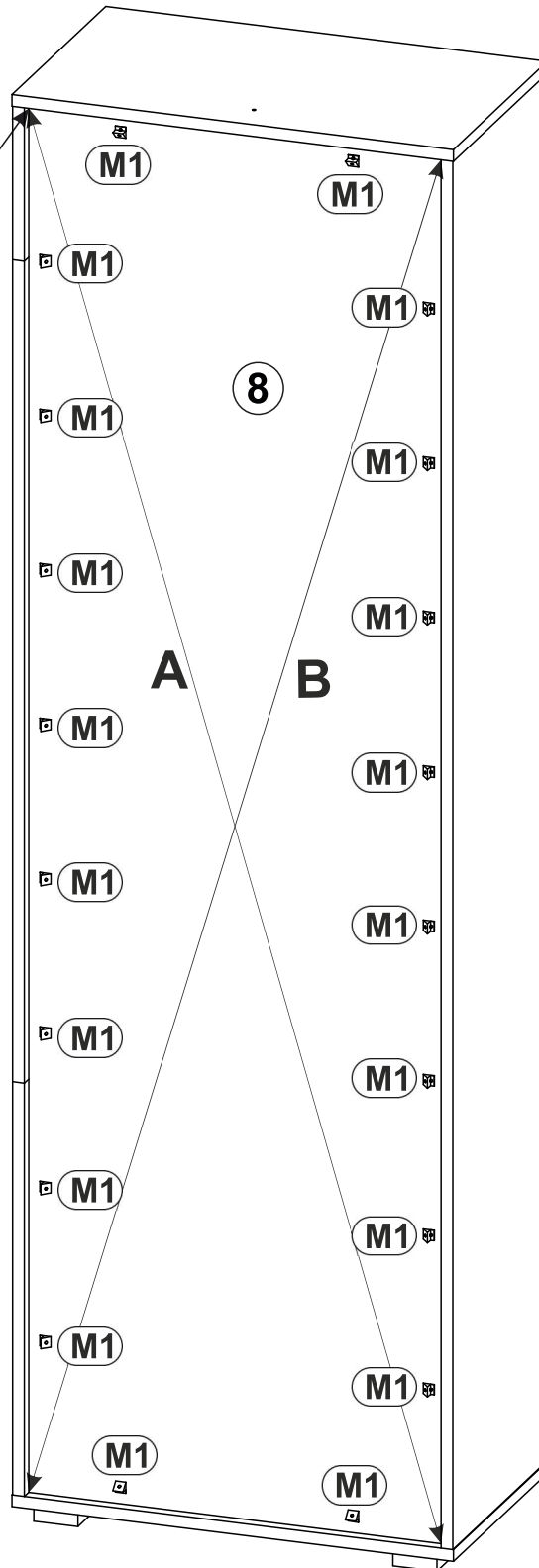
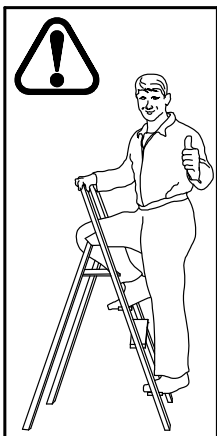
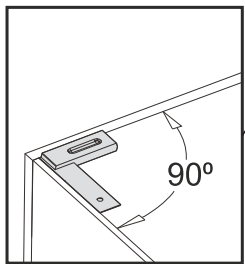

10

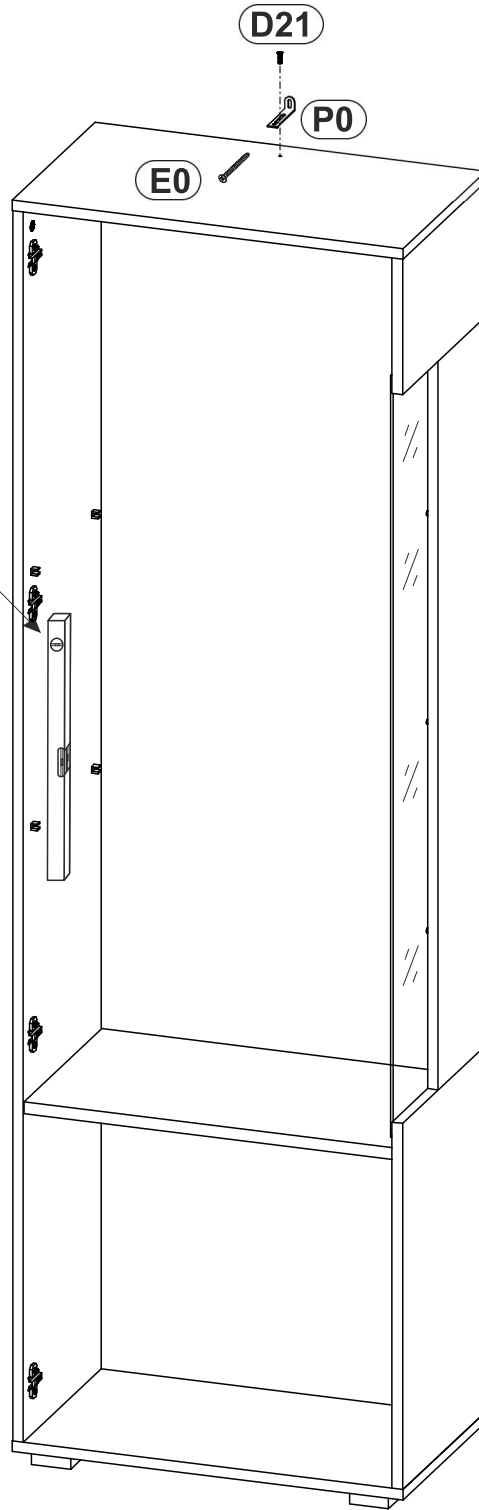

D21 5x13 x1	E0 8x50 x1	P0 x1
-------------------------------------	------------------------------------	----------------------------

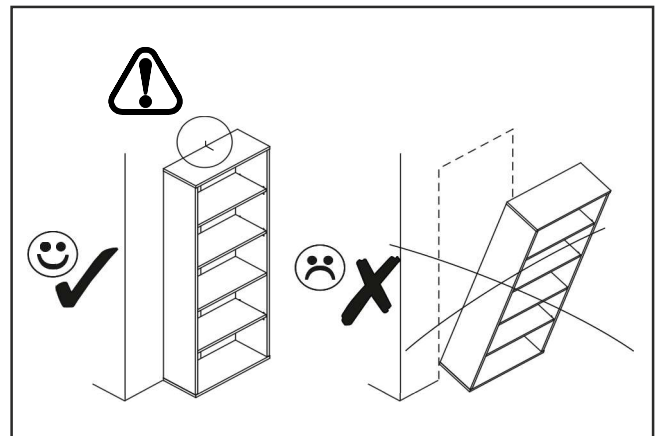
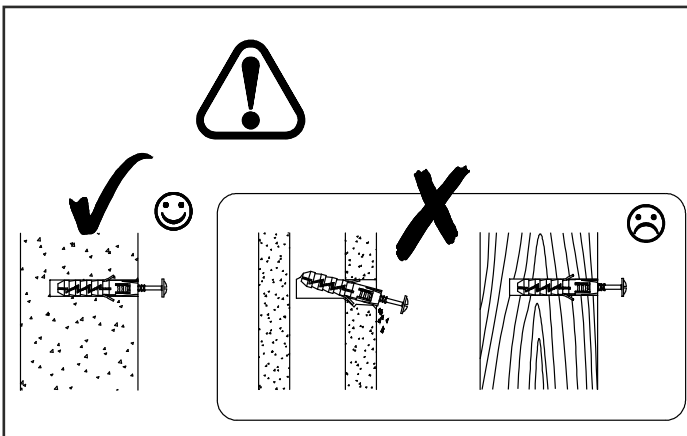
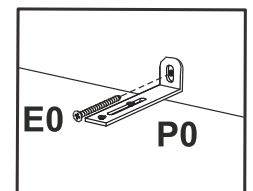
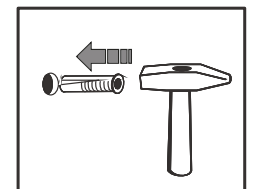
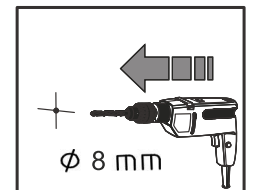
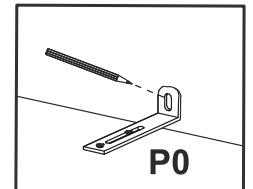
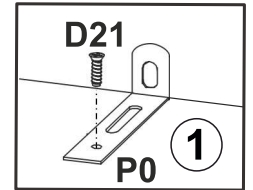
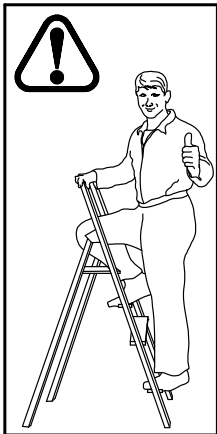
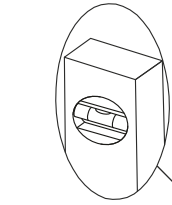

11

C0

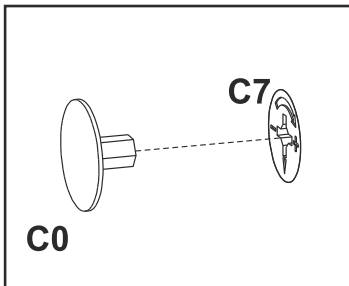
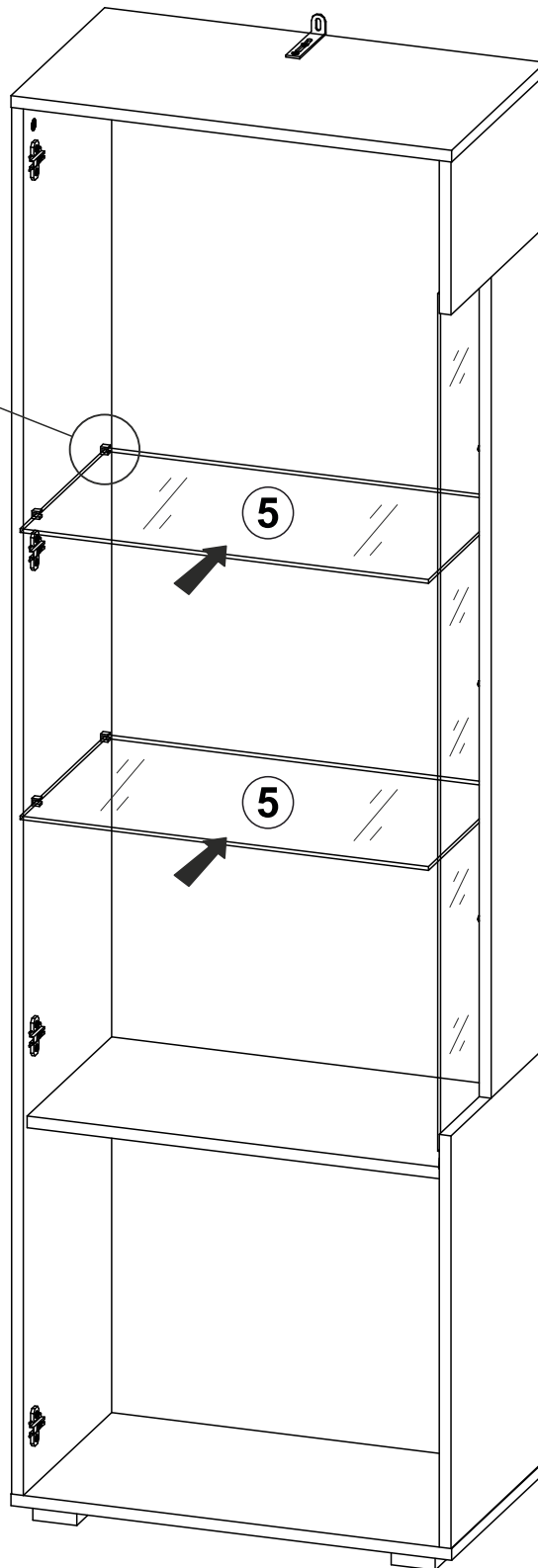
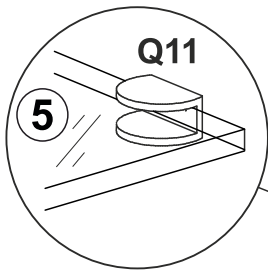
x16



C0

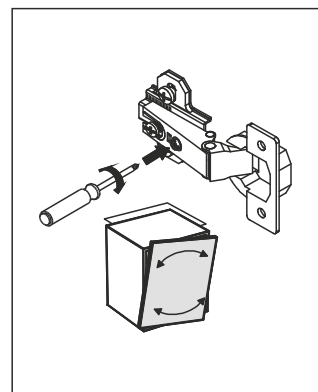
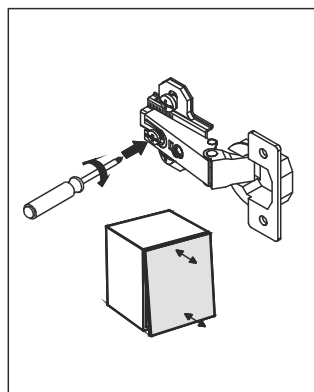
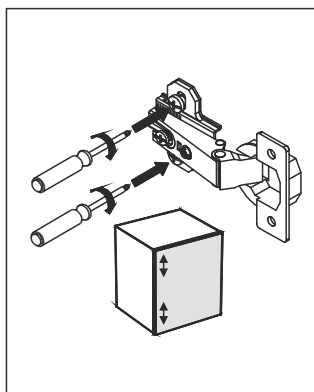
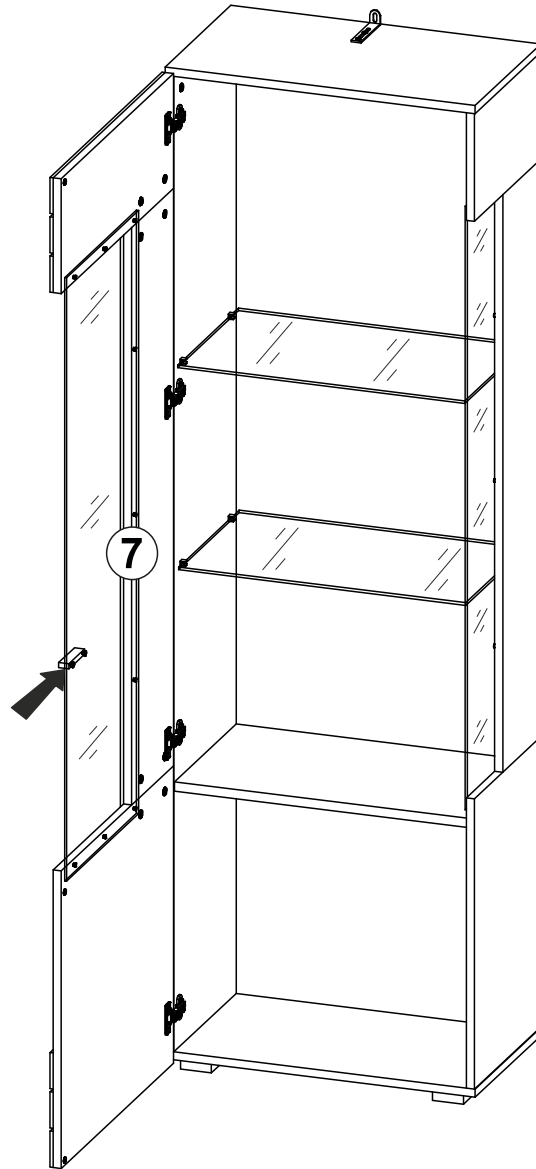
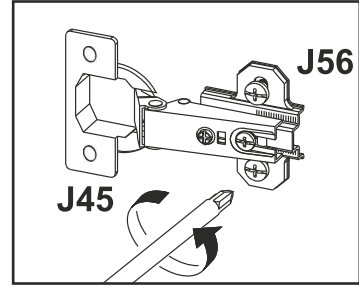
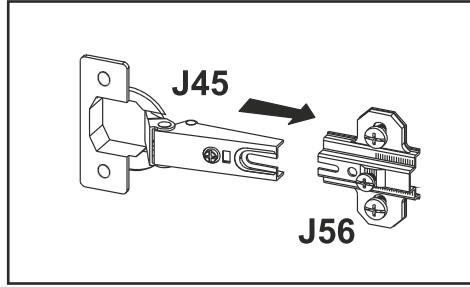
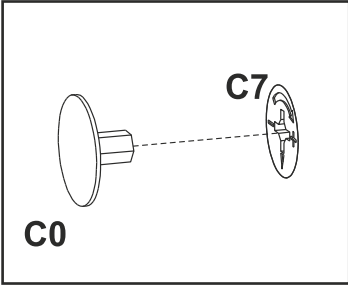

x8



LKZ: XO105

Modellname / Model name / Nom du modèle / Modellnamn / Nome modello / Název modelu / Modelnaam / Ime modela / Número Modelo / Modell neve / Название модели / Názov modelu / Ime modela / Denumire model / Наименование на модела / Nazwa modelu

FRENO

Modellnummer / Number / Numéro du modèle / Numero / Номер на модела / modello / Číslo modelu / Modell száma / Éislo modelu / Številka modela / Număr model / Broj modela / Modelnummer / Numer modelu

X30 A2 T30

Type / Tipo / Típus / Typ / Тип / Tip

T30

01.12.2021

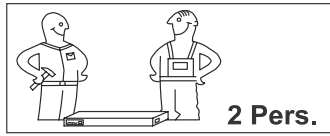
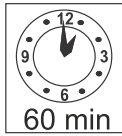

2 Pers.

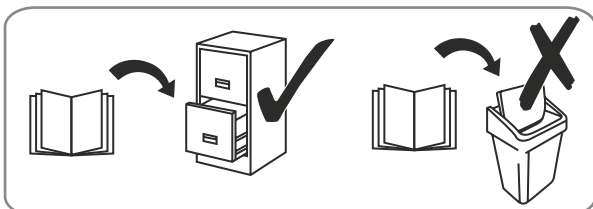
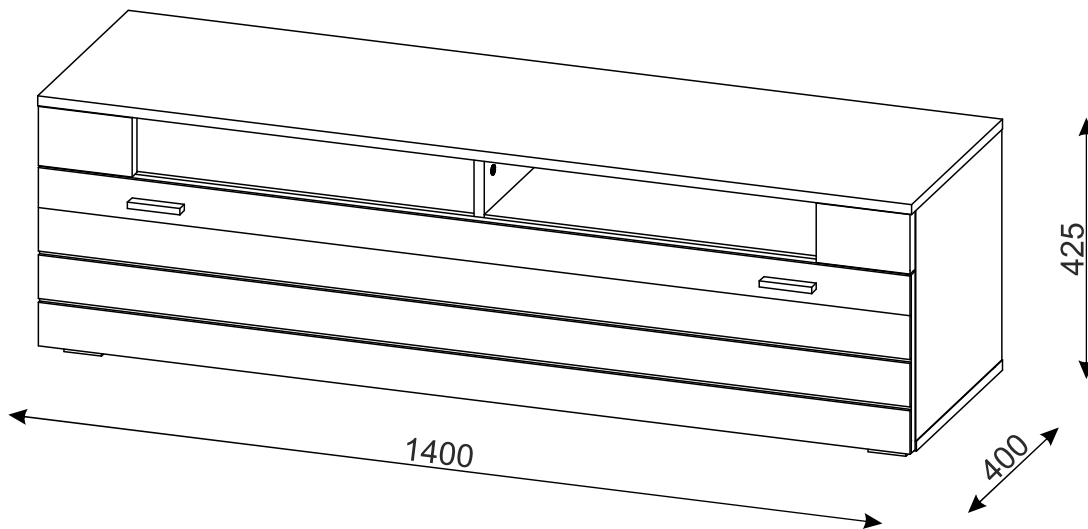
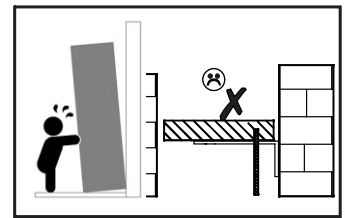
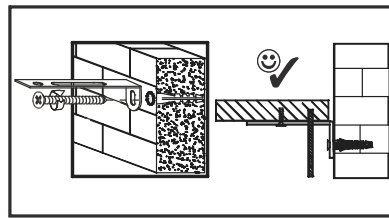
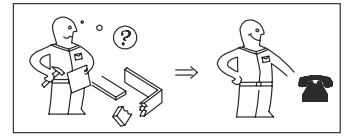
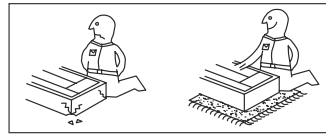

Wichtig - Für spätere Verwendung aufbewahren - sorgfältig lesen!

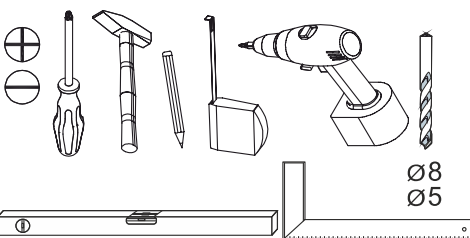

2 Pers.



60 min



festziehen / tighten / Затягнете / serrer / stringere / utåhnut / vasttrekken / zategnuti / strängere / zwiázac / zacisnąć / szorosan meghúzni / pevne dotiahnut / trdno pritegniti / затянуть / dra át



eindrücken / press in / enfoncer / wcisnąć / ribattere / zatlačit / Вкарайте / Indrukken / benyomni / silacit' / vtisniti / tryck in / introducere prin apă sare / вдавить



ausmessen / measure / mesurer / măsurare / opmeten / izmeriti / miara / kimérni / izmeriti / măsurare / измерить / změřit / Измерете / mät upp / zmierzyc



drücken / press / presser / stisknout / Натиснете / vtisniti / nasinac / drukken / pritisnuti / nacisnac / pritisniti / нажать / (meg)nyomni / apasare / tryck fast / nacisnąć



einschlagen / hammer in / beverni / slå in / frapper au marteau / infossare / Zabit' / zarazit' / Набийте / zabiti / wbić / introduce prin bătaie / забить / zaľouct



Drehen - wenden / przekrećić - odwrócić / Keren - omdraaien / Girare - Ruotare / Okrenuti - ubnuti / Retourner - renverser / Turn over - turn around / Otocte - obratne / Zавърте - обърнете / Obrnite list / Întoarceți - rotiți / Vrid runt - vänd / прокрутите - поверните / otočit - obrátit / elforgatni - megfordítani

LKZ: XO105

Modellname / Model name / Nom du modèle / Modellnamn
Nome modello / Název modelu / Modelnaam / Ime modela
Número Modelo / Modell neve / Название модели /
Názov modelu / Ime modela / Denumire model /
Наименование на модела / Nazwa modelu

FRENO

Modellnummer / Number / Numéro du modèle
Numero / Номер на модела / modello
Číslo modelu / Modell száma / Ěíslo modelu
Številka modela / Numár model / Broj modela
Modelnummer / Numer modelu

X30 A2 T30

Type / Tipo / Típus / Typ / Тип / Tip

T30

01.12.2021

D Unser Direktservice für Beschlagteile
Sollte Ihnen ein Beschlagteil fehlen, können Sie diese Servicekarte direkt an die untenstehende Adresse mailen. Wir können allerdings nur Beschlagteile auf diesem Wege verschicken. Sollten Sie eine andere Beanstandung an Ihrem Möbelstück haben, so wenden Sie sich bitte direkt an Ihr Möbelhaus.

GB Our direct order service for fitting
If a fitting part is missing, you can e-mail this service card directly to the address below. However, we can only send fitting parts in this way. If you have any other cause for complaint concerning your item of furniture, please contact your furniture store directly.

CZ Náše přímé služby pro kování
Chybí-li vám nějaký díl z kování, můžete tuto servisní kartu odeslat e-mailem přímo na níže uvedenou adresu. Touto cestou však můžeme zoslat jen díly kování. Pokud byste reklamovali jiný díl nábytku, obraťte se přímo na svého prodejce nábytku.

F Bien étudier la notice de montage
S'il vous manque une ferrure, veuillez envoyer directement la présente carte service à l'adresse e-mail indiquée ci-dessous. Cependant, ceci nous permet uniquement d'envoyer des ferrures. Pour tout autre type de réclamation concernant votre meuble, veuillez contacter directement votre magasin d'ameublement.

I Il nostro servizio diretto per l'ordine della ferramenta
Qualora Vi dovesse mancare un pezzo di fissaggio, allora Vi preghiamo di inviare questa carta di servizio immediatamente all'indirizzo sottostante. Possiamo inviare i pezzi di fissaggio solamente per mezzo di questo procedimento. Qualora dovete avere qualche altra reclamazione in merito al mobile, allora Vi preghiamo di rivolgerVi direttamente al Vostro Negozio di mobili.

BG Нашата директна услуга за обкове
Ако липсват части от комплекта, попълнете настоящата сервисна карта и ни я изпратете на e-mail адреса, посочен по-долу. По този начин можем да доставим само липсващи елементи от обковете. Ако установите други дефекти по мебелите, Ви съветваме да се обърнете към мебелната къща/магазин, от който сте закупили стоката.

NL Onze directservice voor losse onderdelen
Wanneer er een onderdeel ontbreekt, kunt u deze servicekaart direct aan onderstaand e-mailadres sturen. Wij kunnen langs deze weg echter alleen beslagdelen versturen. Mocht u een ander probleem aan uw meubel hebben, verzoeken wij u contact op te nemen met uw meubeldealer.

PL Nasz bezpośredni serwis czeski montażowy
Jeżeli brakuje części koniecznych do montażu, prosimy o przesłanie nam niniejszej karty serwisowej na niżej podany adres e-mailowy. W ten sposób możemy przesłać Państwu tylko brakujące części. W przypadku innych reklamacji dotyczących mebla, prosimy zgłosić się do salonu meblowego, w którym został dokonany zakup.

HR Servis za okove
U slučaju da nedostaje neki od dijelova molimo vas da na dolje navedenu mail adresu pošaljete ovaj servisni obrazac. Na ovaj način mogu se dostaviti samo okovi. U slučaju da imate dodatne prigovore vezane uz komad namještaja molimo vas da se obratite izravno trgovini namještaja gdje je isti kupljen.

HU Direktszolgáltatunk vasalatok esetén
Ha hiányzik egy vasalat, ezt a kártyát közvetlenül elküldheti az alább található címre. Azonban csak vasalatoskat tudunk így küldeni. Amennyiben másfajta reklamáció áll fenn bútordarabját illetően, forduljon közvetlenül a bútortárházhoz.

SK Náš priamy servis pre časti kovania
Ak by Vám chýbala nejaká časť kovania, môžete poslať túto servisnú kartu poslať e-mailom na nižšie uvedenú adresu. Diely kovania vieme poslať iba týmto spôsobom. Ak by ste mali inú reklamáciu ohľadom Vašho nábytku, obráťte sa priamo na Vašu predajňu nábytku.

SLO Náše direktno uslužne storitve za okovje
Če vam manjka kakšno okovje, lahko to servisno kartico pošljete po e-pošti direktno na spodnji naslov. Po tej poti vam lahko pošljemo samo okovje. Če želite reklamirati kakšen drug del pohištva, se obimite neposredno na vašo trgovino pohištva.

RO Service-ul nostru direct pentru feronerie
În cazul în care vă lipsește o piesă de feronerie puteți să trimiteți direct acest card de service prin e-mail la adresa de mai jos. Noi nu putem expedia piese de feronerie decât pe această cale. Dacă aveți o altă reclamație referitoare la piesa de mobilier, atunci vă rugăm să vă adresați direct la magazinul dvs. de mobilă.

RUS Наш прямой сервис для поставок фурнитуры
Если окажется, что Вам не хватает того или иного элемента фурнитуры, Вы можете отправить сервисную карту по факсу непосредственно на нижеприведенный адрес электронной почты. Однако, таким образом мы можем переслать лишь фурнитуру. Если же у Вас возникнут иные претензии относительно приобретенной мебели, пожалуйста, обращайтесь непосредственно в организацию, осуществившую продажу.

S Vår direktservice för beslagsdelar
Om du saknar en beslagsdel kan du skicka detta servicekort direkt till e-postadressen som anges nedan. Tänk på att detta är den enda möjligheten att skicka beslagsdelar till dig. Om du vill reklamera din möbel av en annan anledning måste du kontakta ditt möbelhus direkt.

ES Nuestro servicio directo para accesorios
Si le falta algún accesorio, puede enviar esta tarjeta de servicio directamente a la siguiente dirección. No obstante, por este método solo podemos enviar accesorios. Si tiene alguna otra objeción sobre su mueble, consulte directamente con su mueblería.

TR Donatılar için doğrudan servisimiz
Bir donatınız eksikse bu servis kartını doğrudan aşağıda bulunan adrese doğrudan mail yazabilirsiniz. Sadece bu yolla donatıları gönderebiliriz. Mobilyanızda başka şikayetleriniz varsa lütfen doğrudan mobilya satıcınıza danışın.

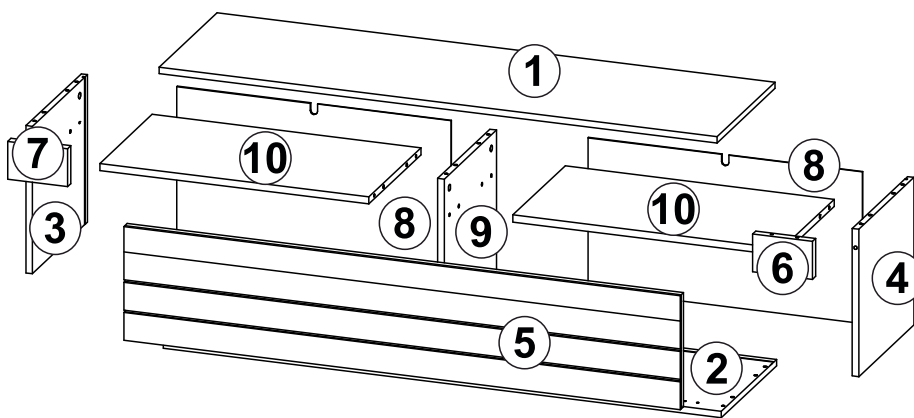
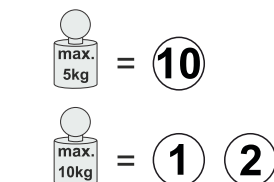

Nr.	Maße mm			Colli	Anzahl
1	1400	400	16	1/2	1
2	1400	380	16	1/2	1
3	370	380	16	1/2	1
4	370	380	16	1/2	1
5	286	1396	22	1/2	1
6	95	150	22	1/2	1
7	95	150	22	1/2	1
8	380	688	3	1/2	2
9	370	360	16	2/2	1
10	675	360	16	2/2	2
B1				1/2	1

Grund der Beanstandung / Reason of the objection:

Möbelhaus / Furniture store:

Name / Name: Telefon / Telephone:

PLZ / postal code: Ort / City:

Strasse / Street:

Haus-Nr. / House No.: @E-Mail:

E-Mail Kundenservice / Customer service e-mail / E-mail servisního střediska / E-mail de notre service clientèle / e-mail servizio clienti / E-mail на отдела за обслужване на клиенти / E-mail klantenservice / E-mail servisu dla klientów / Servisna mail adresa / Az ügyfélszolgálat e-mail címe / E-mail zákaznického servisu / E-pošta Servisna služba / E-mail Serviciu clienți / E-Mail сервисной службы / E-postadress kundservice / Servicio de atención por correo electrónico / Müşteri hizmetleri e-postası

service@xonox-home.com
Hotline xonox.home GmBH
0049-(0)5261-92020800

LKZ: XO105

Modellname / Model name / Nom du modèle / Modellnamn
Nome modello / Název modelu / Modelnaam / Ime modela
Número Modelo / Modell neve / Название модели /
Názov modelu / Ime modela / Denumire model /
Наименование на модела / Nazwa modelu

FRENO

Modellnummer / Number / Numéro du modèle
Numero / Номер на модела / modello
Číslo modelu / Modell száma / Ěíslo modelu
Številka modela / Număr model / Broj modela
Modelnummer / Numer modelu











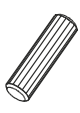

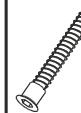



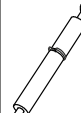



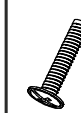

X30 A2 T30

Type / Tipo / Típus / Тип / Тип / Tip

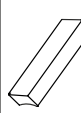
T30



01.12.2021

B1 (COLLI 1/1)

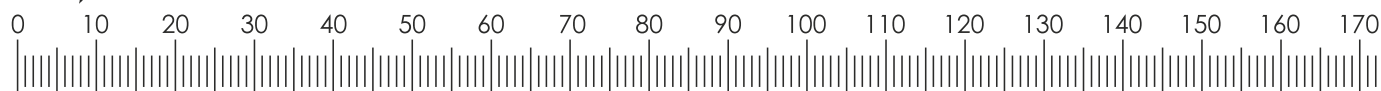
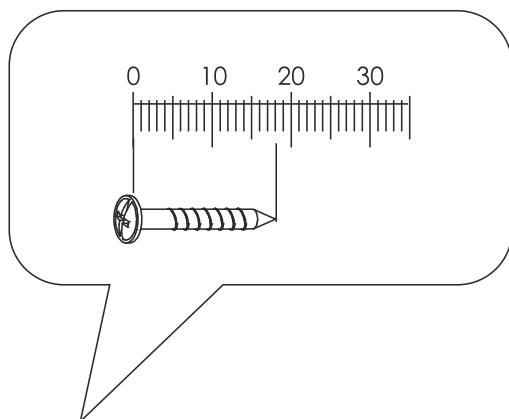
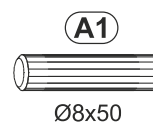
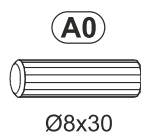
A0  Ø8x30 x18	A1  Ø8x50 x2	B0  x6	B1  Ø7x50 x6	C0  x18	C2  x14	C7  16 mm x18	C8  x2	D0  3x15 x16	D5  3.5x16 x8	D21  5x13 x2
D37  4x20 x10	E0  8x50 x2	F1  x2	H10  4x30 x4	J45  x4	J56  x4	K  4mm x1	L54  x2	M1  x14	M3  x2	P0  x2
T19  x5	U0  x3									



1

D37  4x20 x10	J56  x4	T19  x5
---	--	--

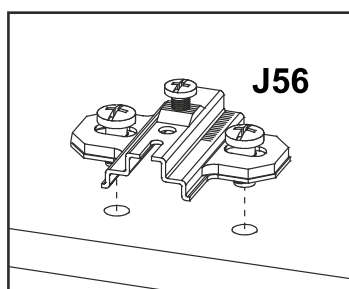
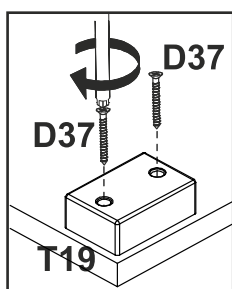
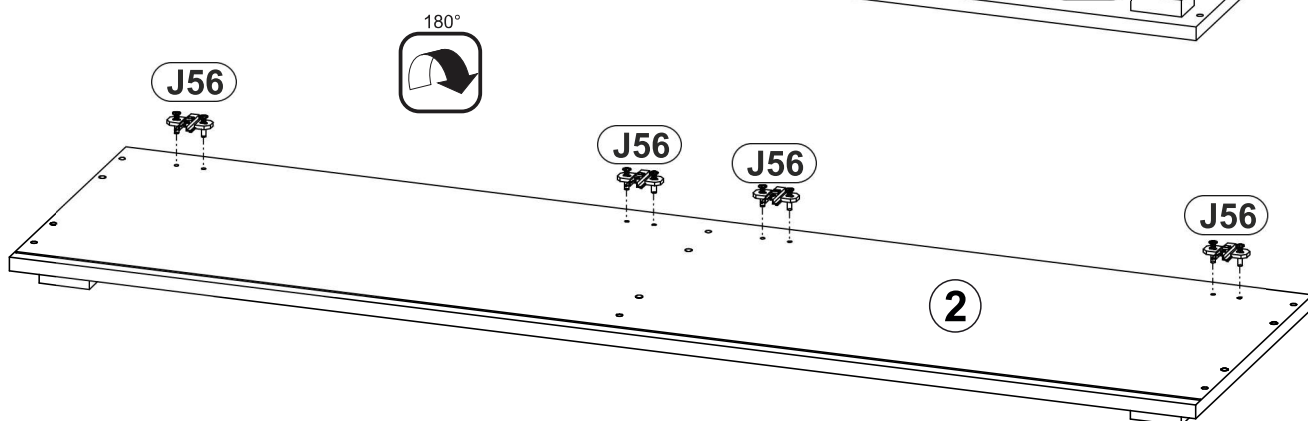
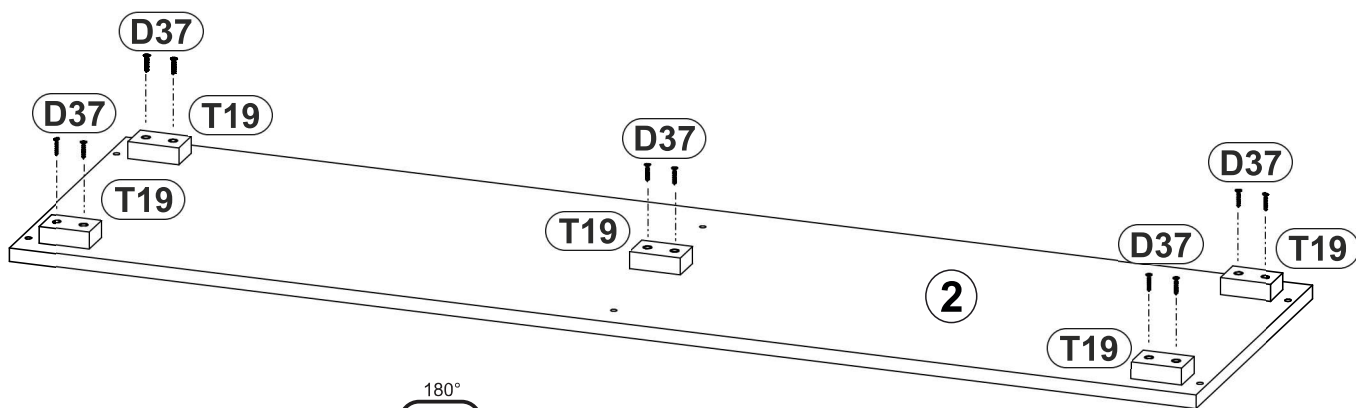
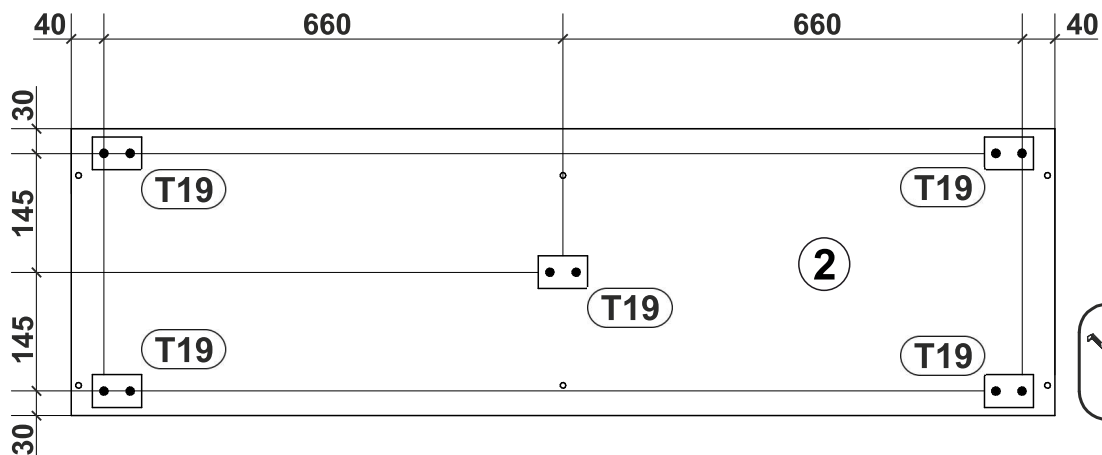

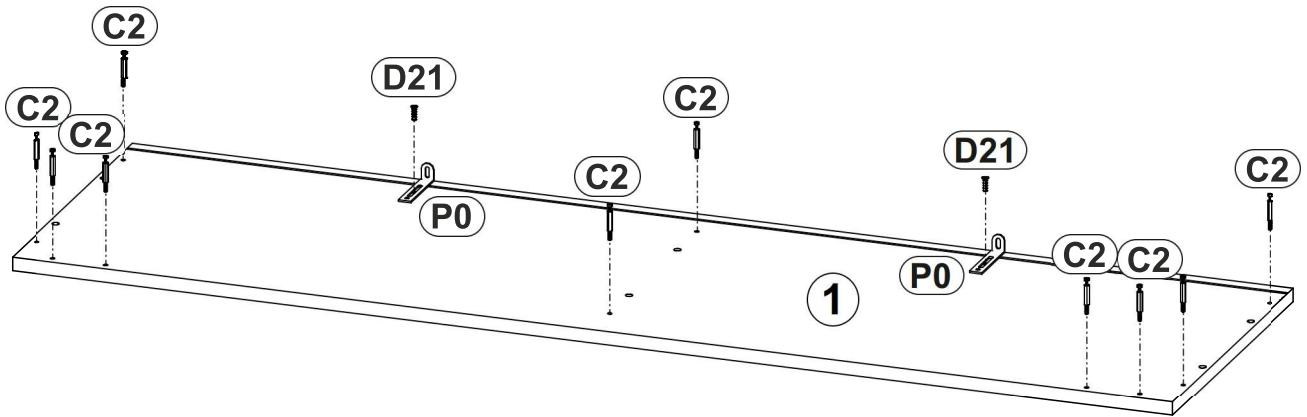
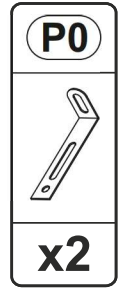
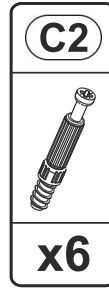
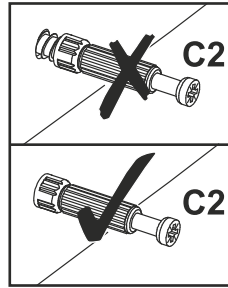
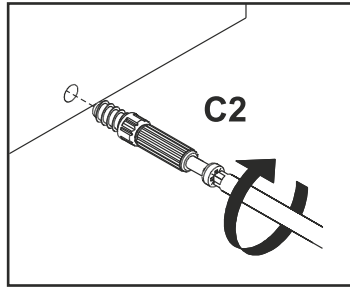
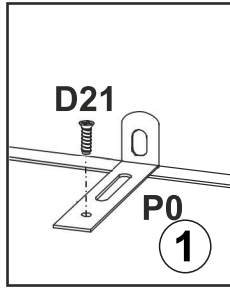

2

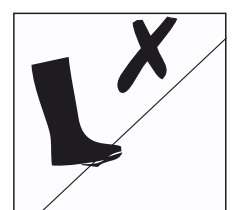
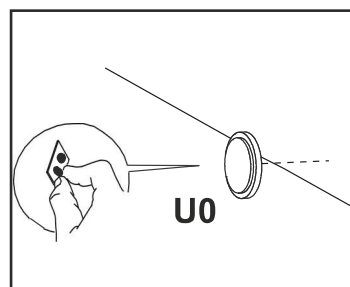
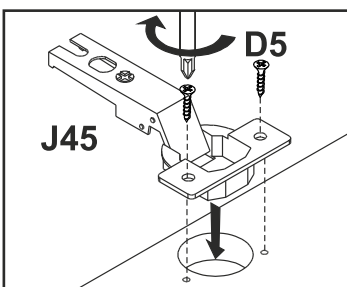
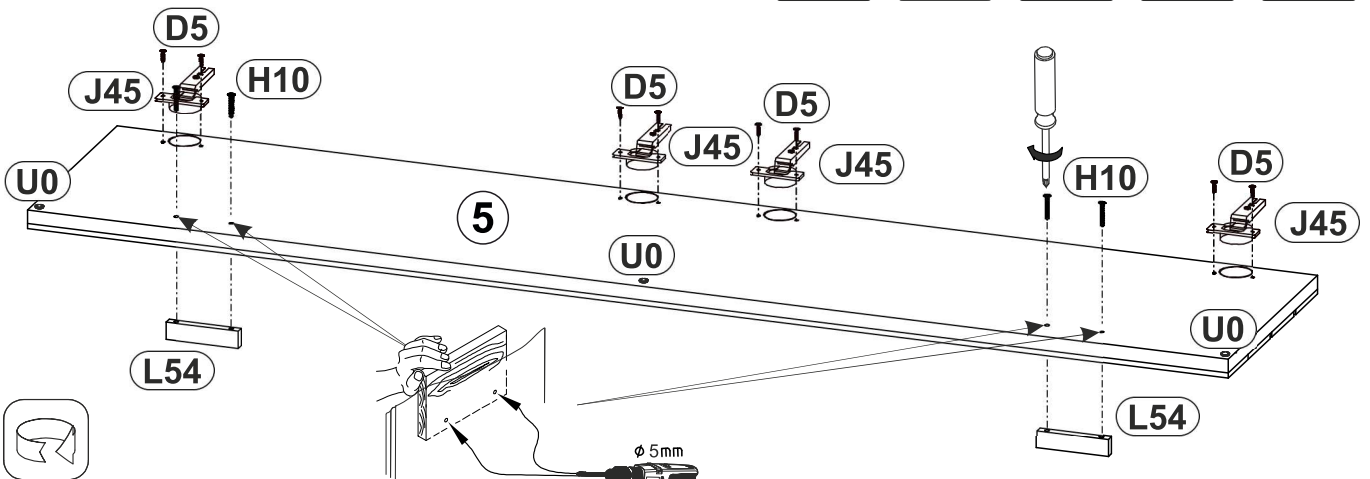
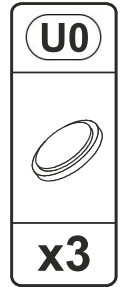
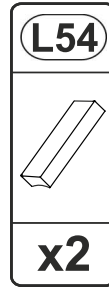
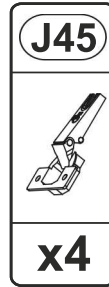
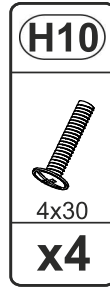
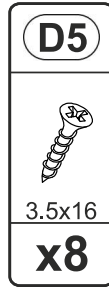
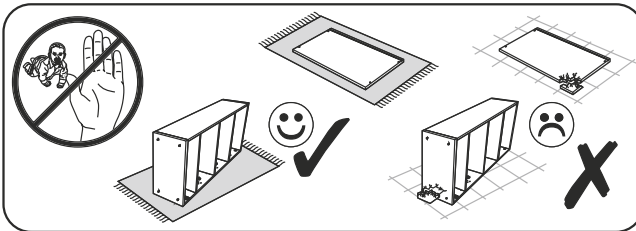

3



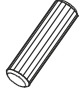

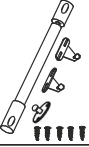
4

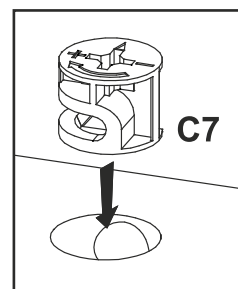
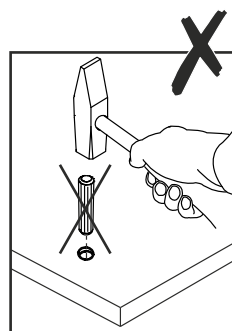
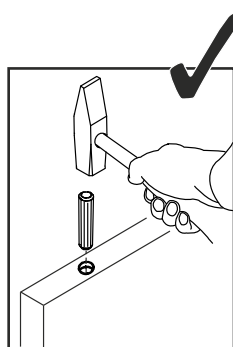
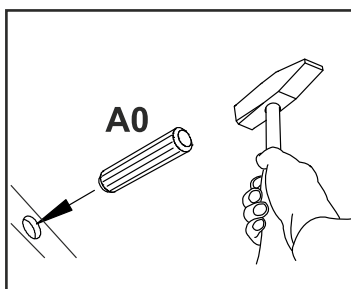
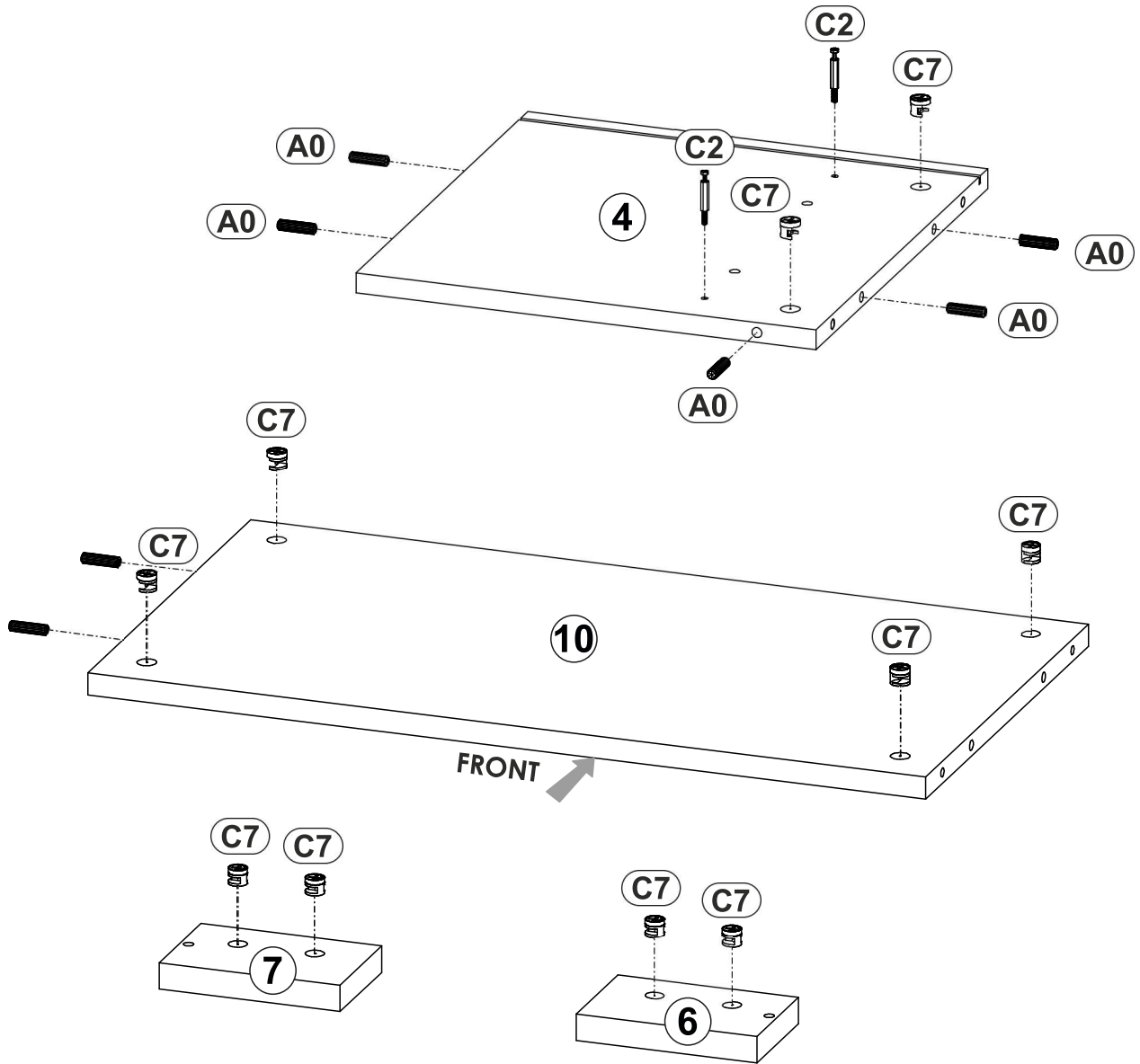
A0  Ø8x30 x18	C2  x14	C7  16 mm x18	F1  x2
---	--	---	---

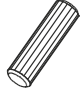

5

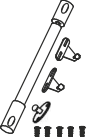
A0	C2	C7	F1
			
Ø8x30		16 mm	
x18	x14	x18	x2

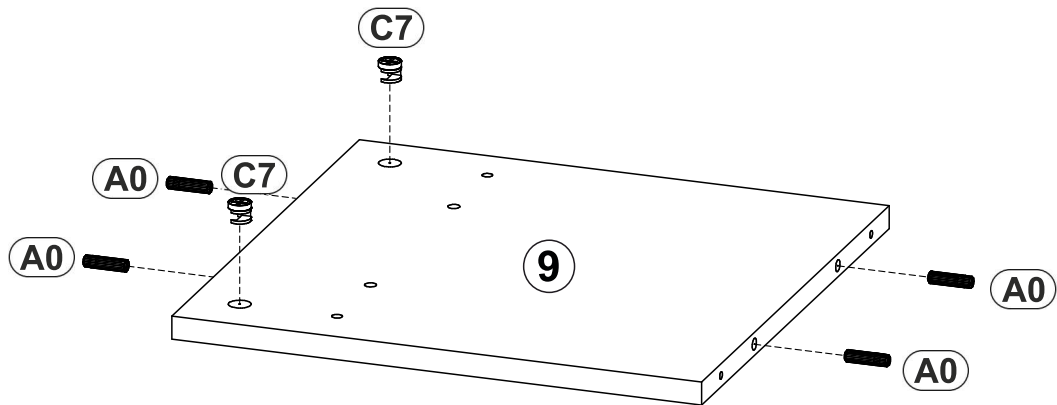
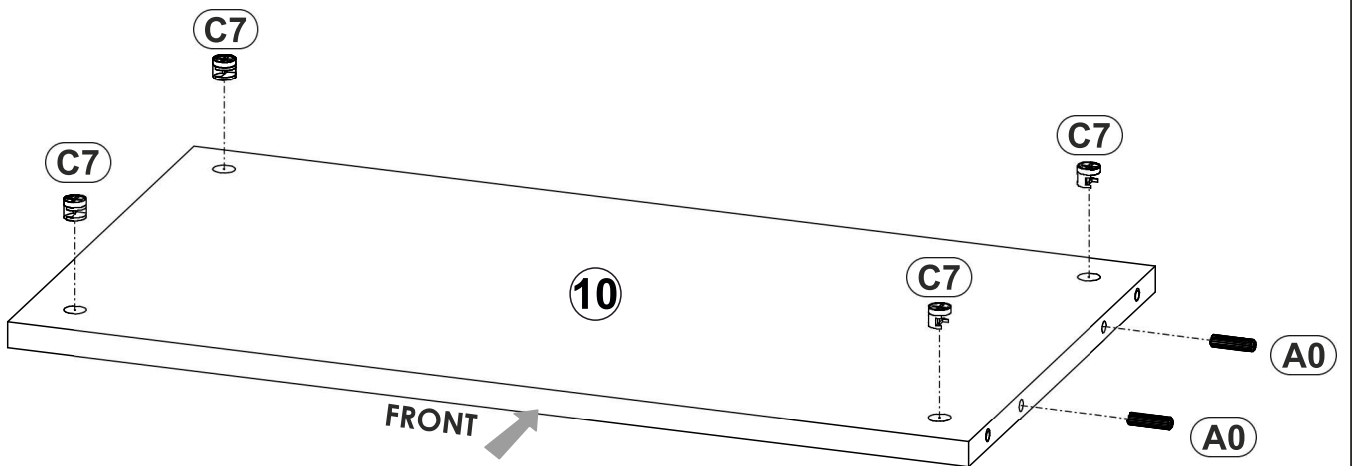
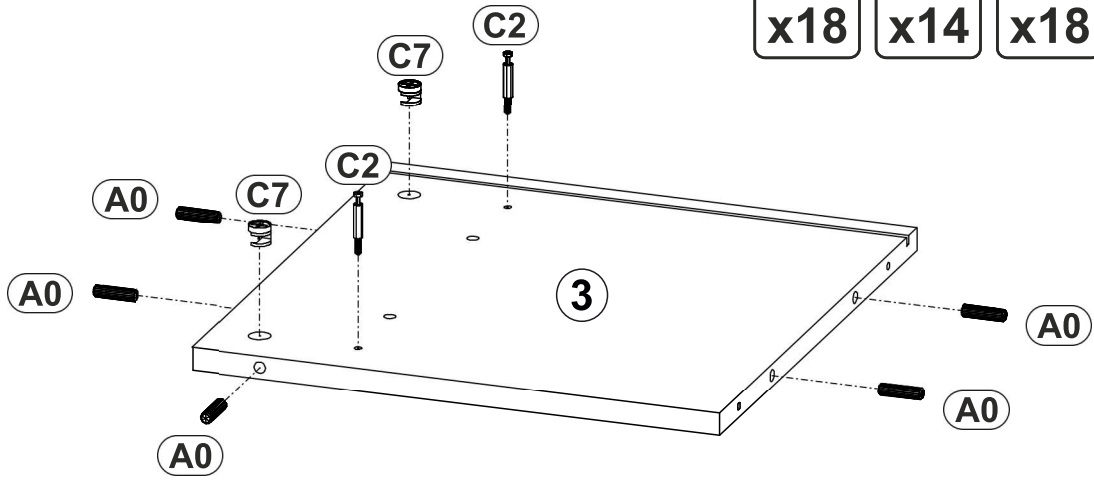

6

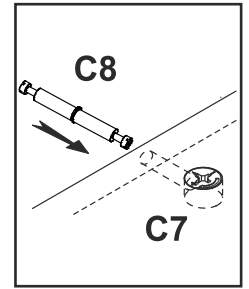
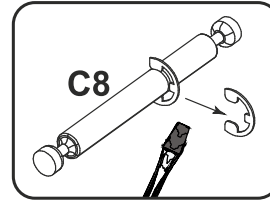
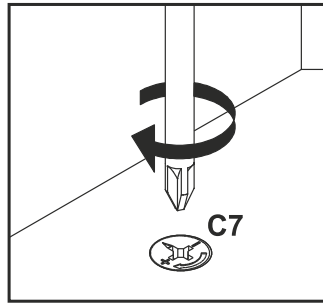
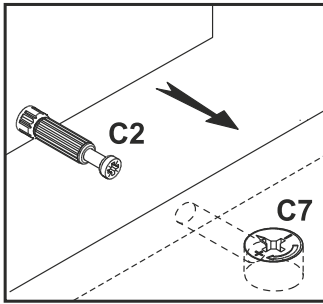
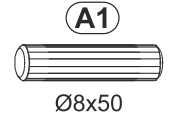
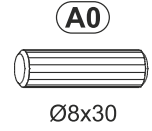
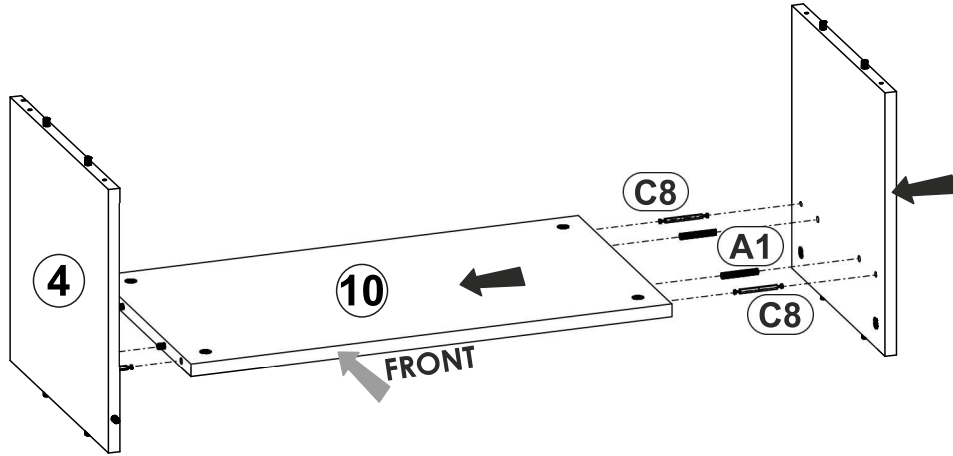
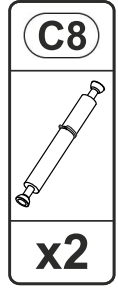
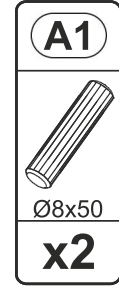
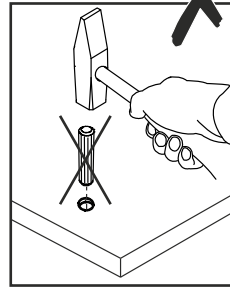
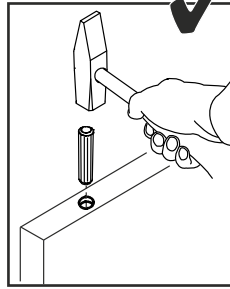
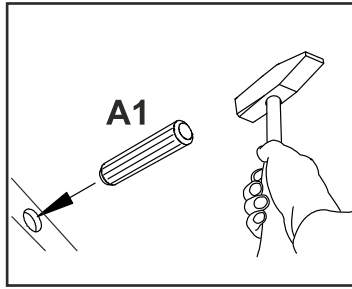

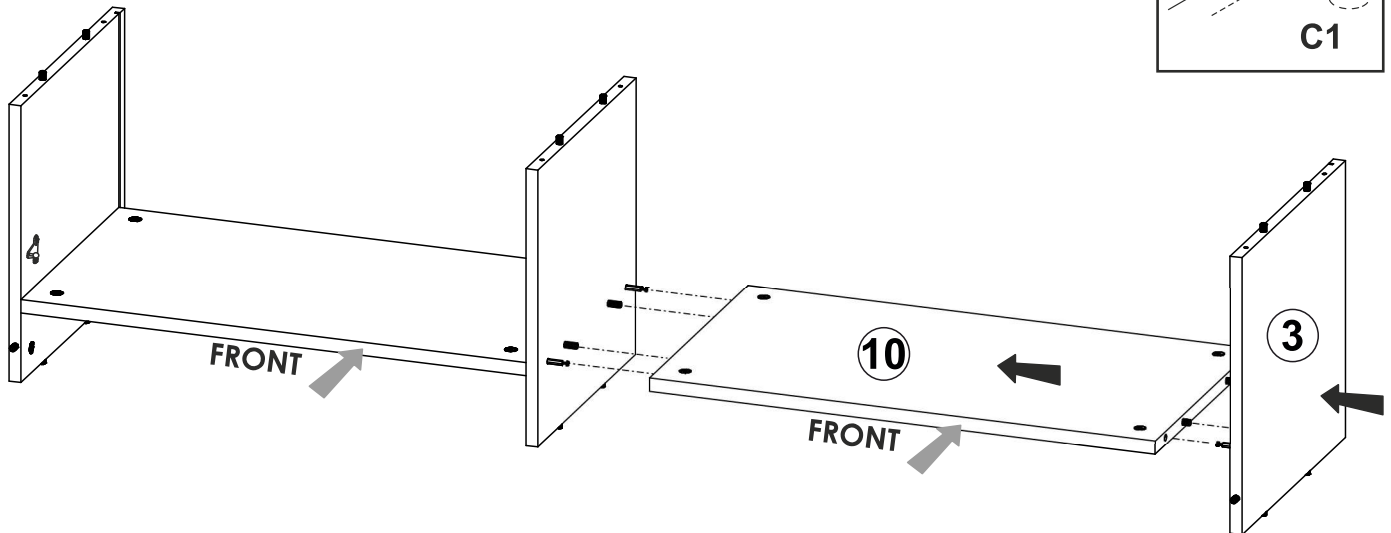
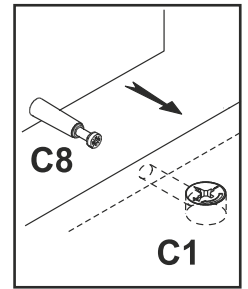

7

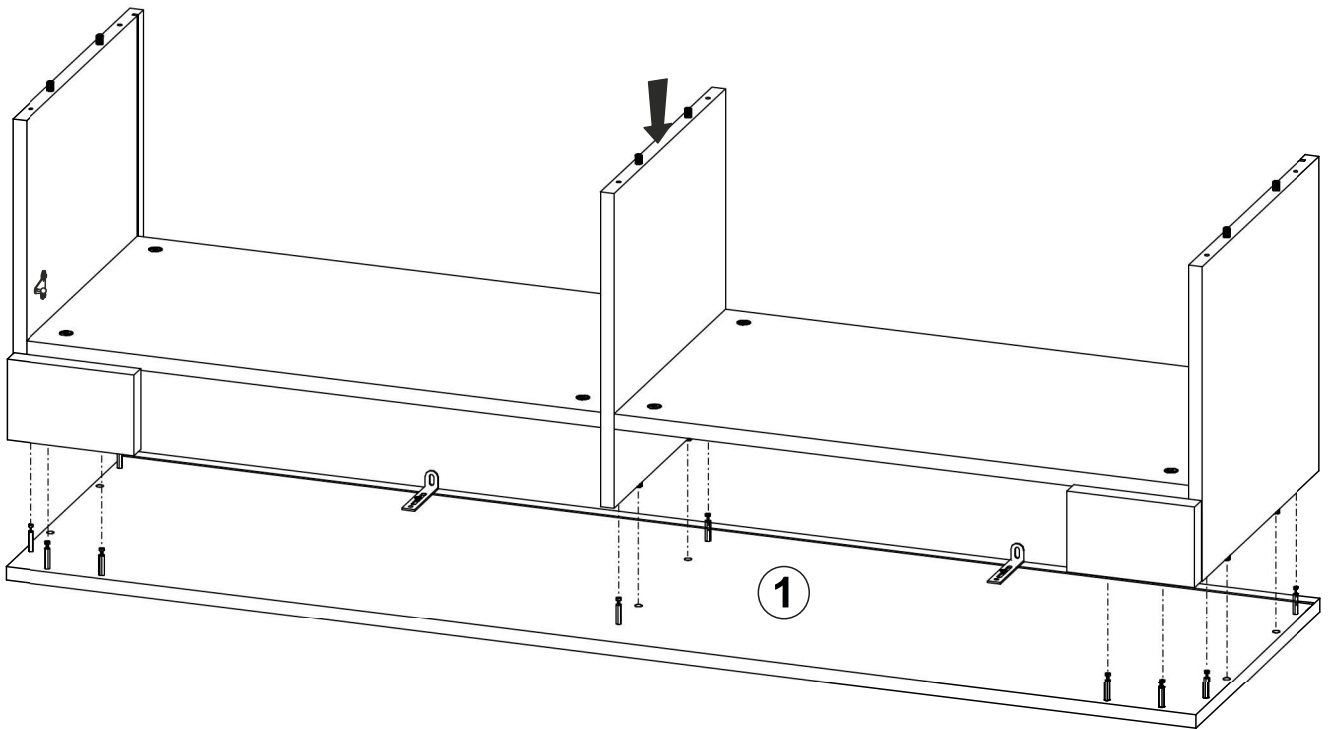
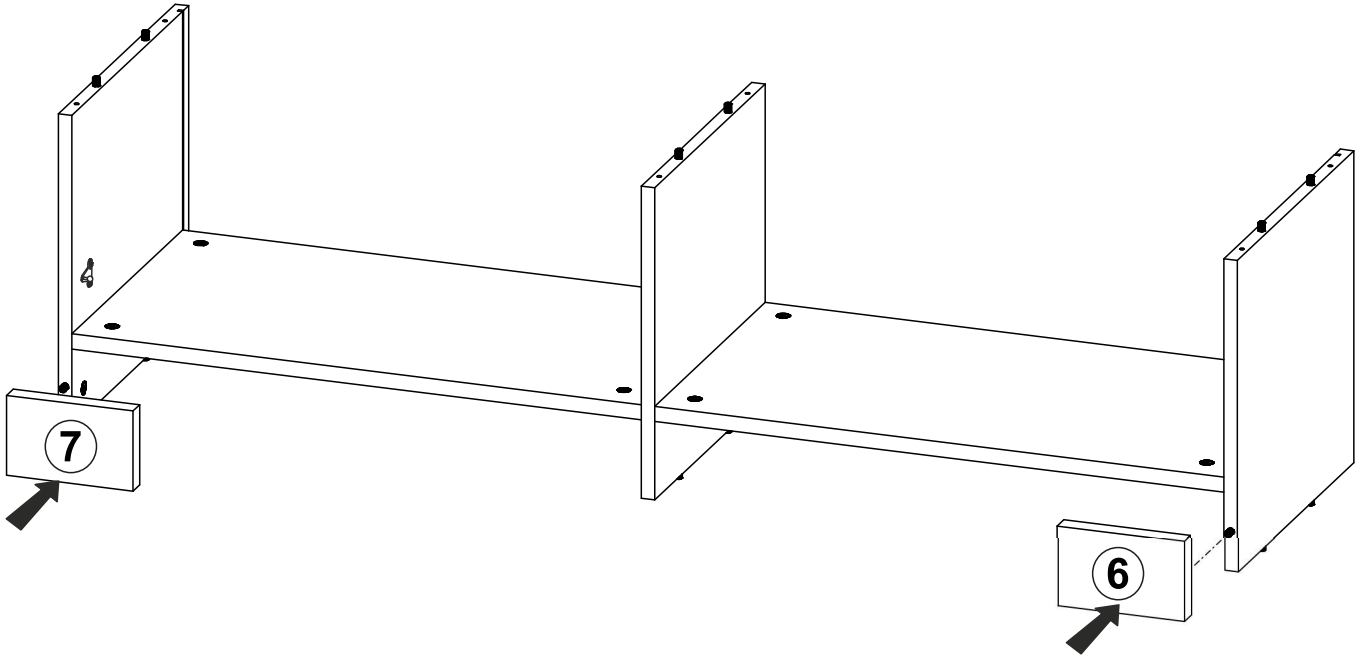

8



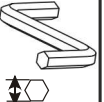

9

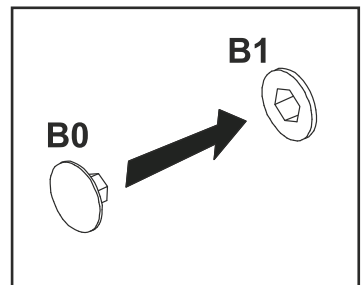
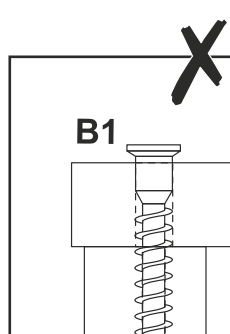
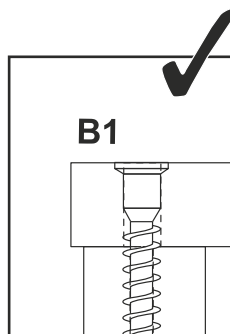
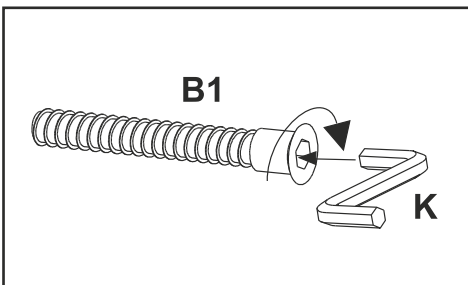
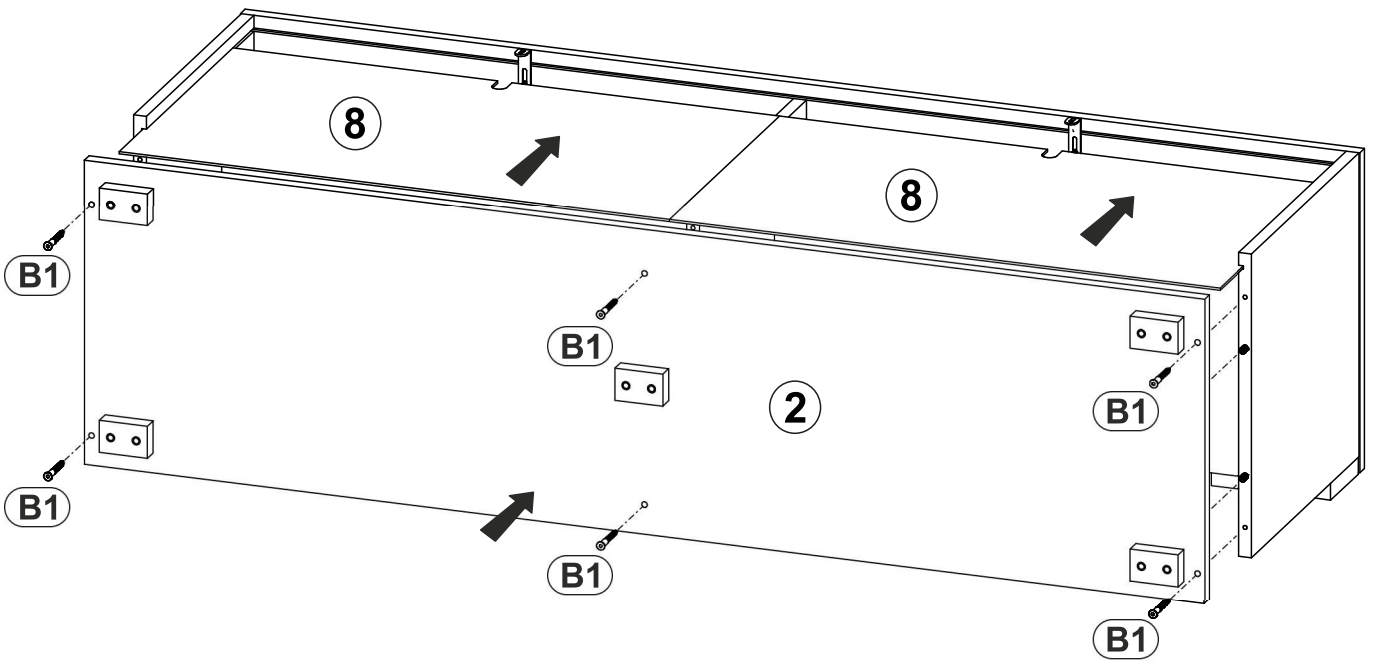
B0	B1	K
	 Ø7x50	 4mm
x6	x6	x1

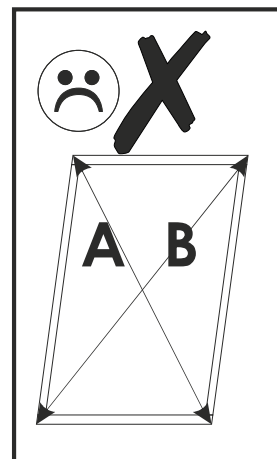
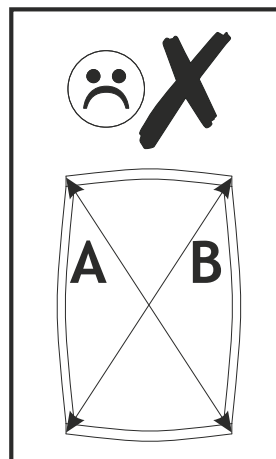
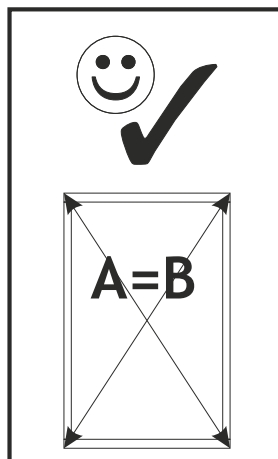
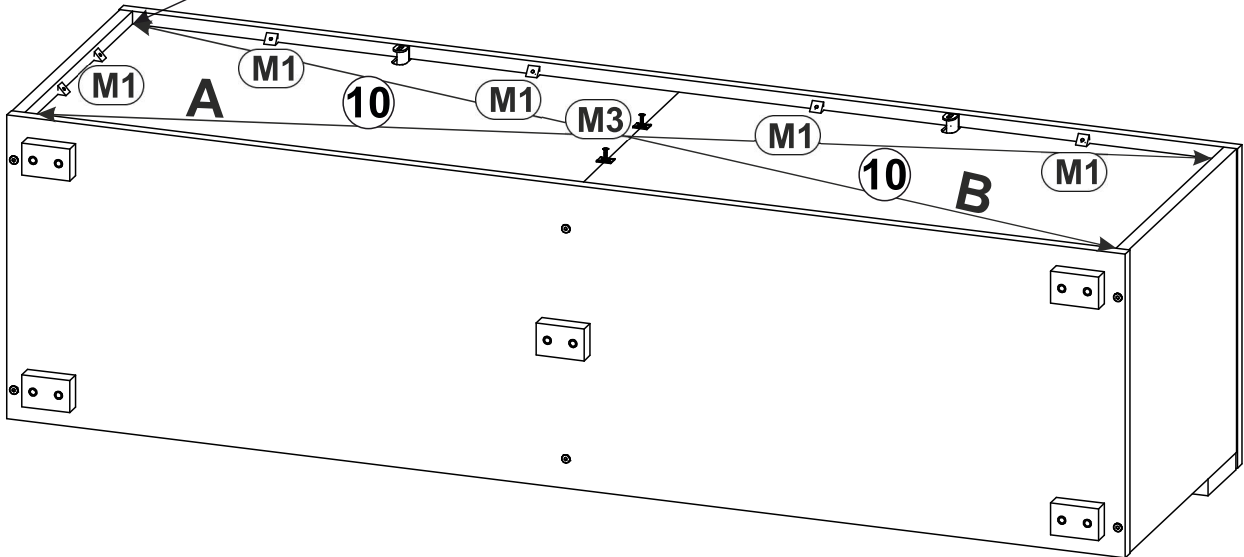
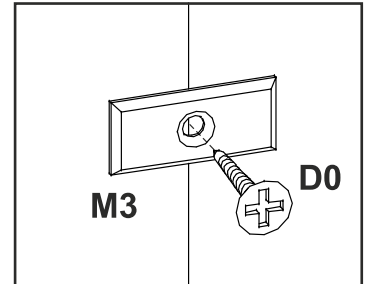
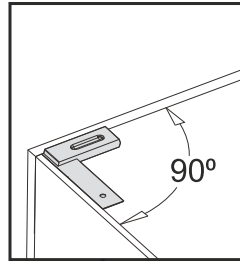
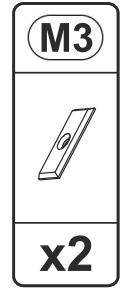
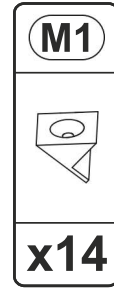
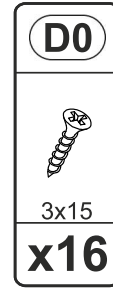
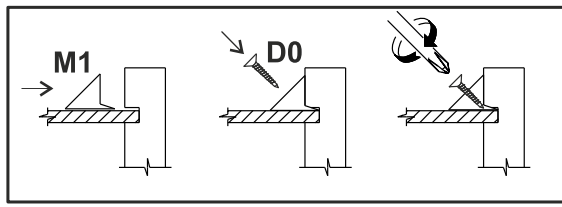
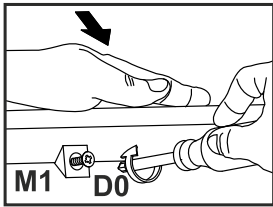

10

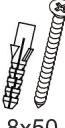

C0	E0
	
x18	x2

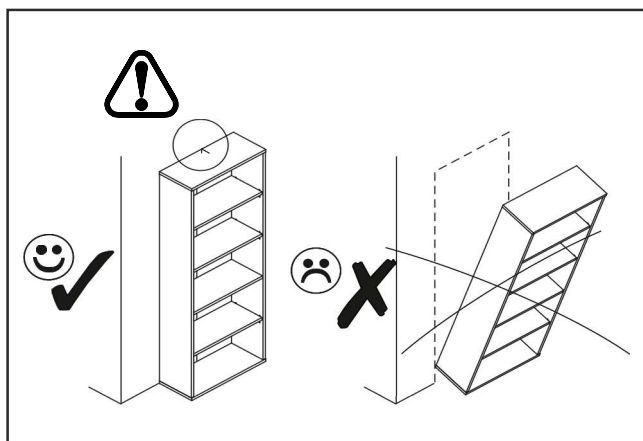
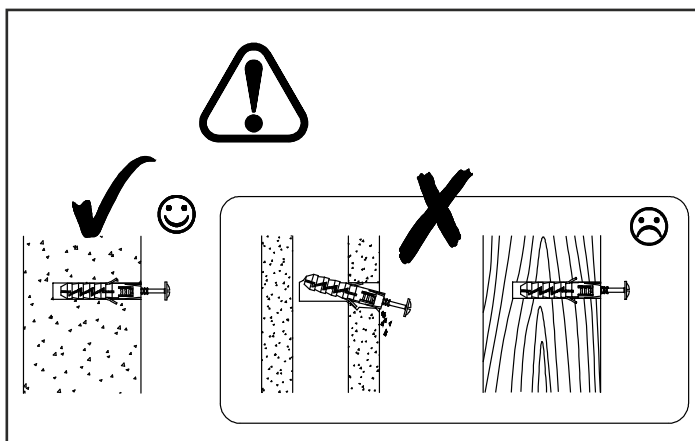
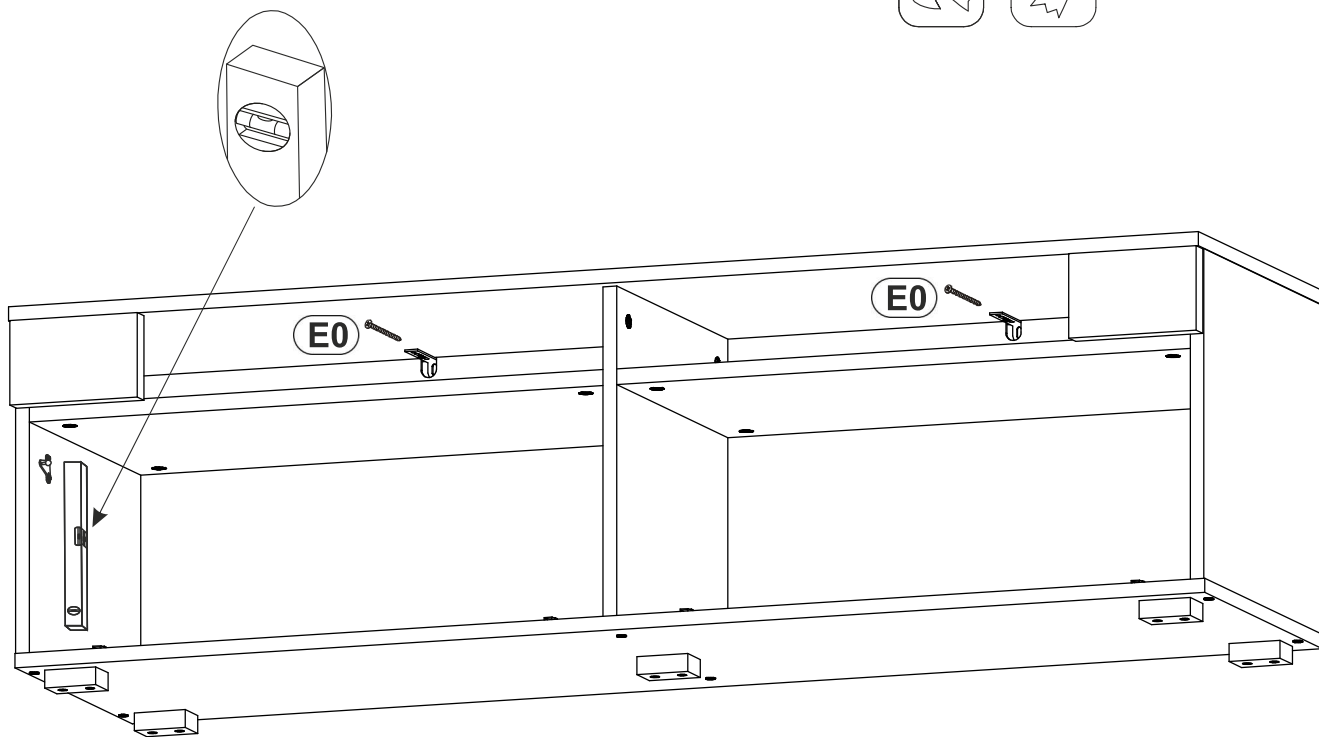
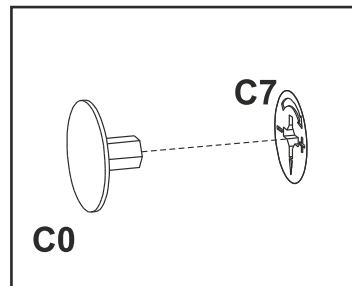
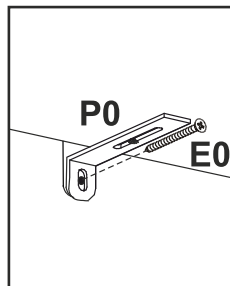
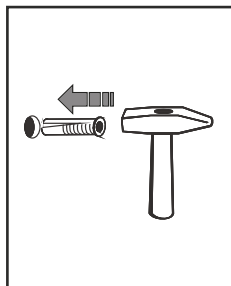
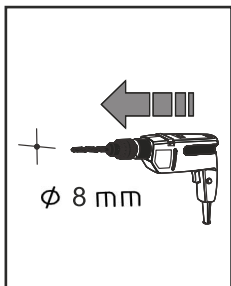
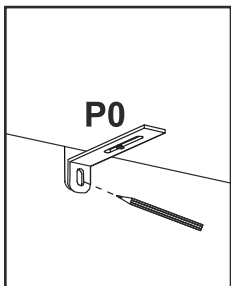

12

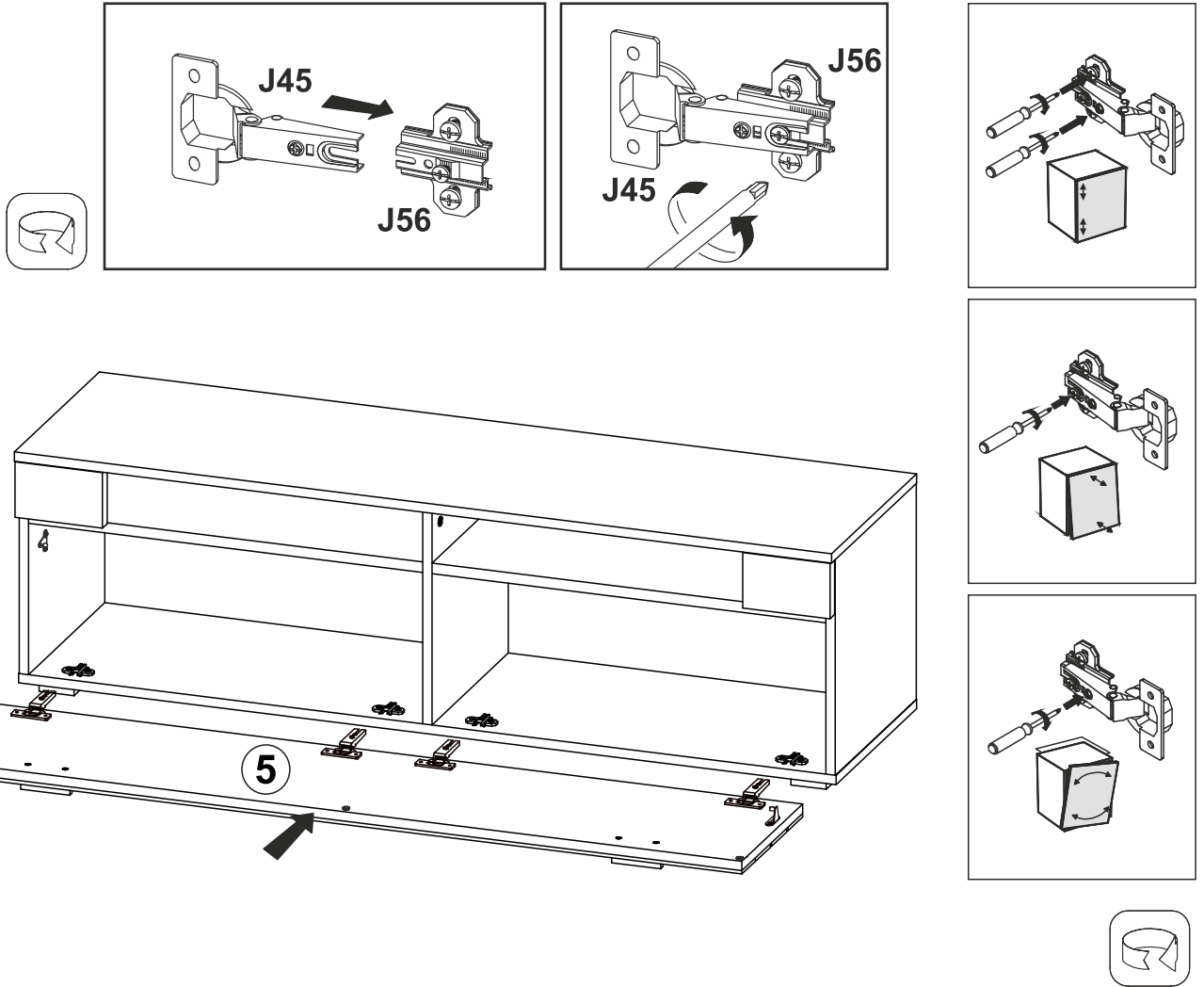

13

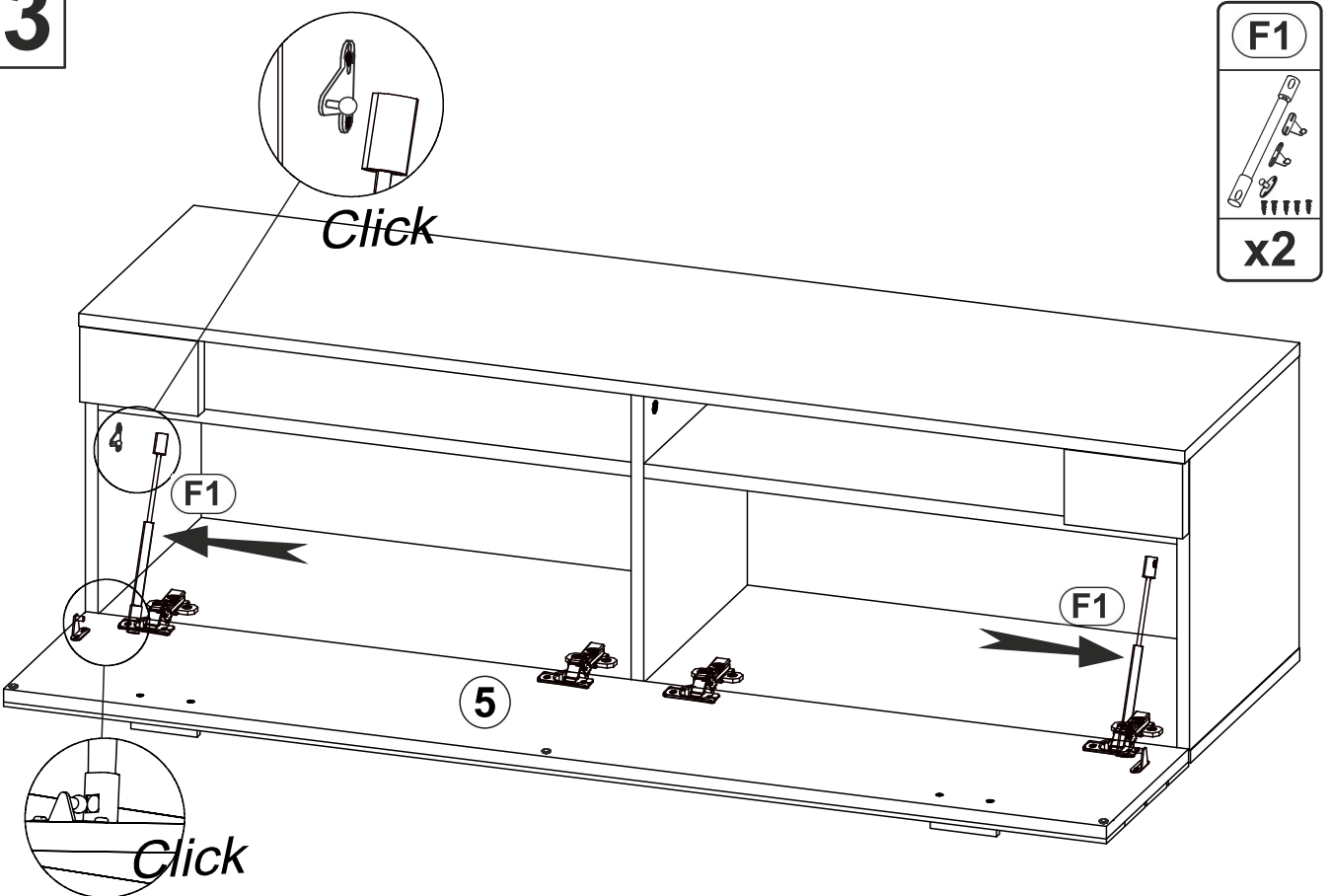

LKZ: X0105

Modellname / Model name / Nom du modèle / Modellnamn
 Nome modello / Název modelu / Modelnaam / Ime modela
 Numéro Modelo / Modell neve / Название модели /
 Názov modelu / Ime modela / Denumire model /
 Наименование на модела / Nazwa modelu

FRENO

Modellnummer / Number / Numéro du modèle
 Numero / Hoмep на модела / modello
 Číslo modelu / Modell száma / Éíslo modelu
 Številka modela / Număr model / Broj modela
 Modelnummer / Numer modelu

X30 A2 T50

Туре / Тиро / Тípus / Тур / Тип / Тір

T50

01.12.2021

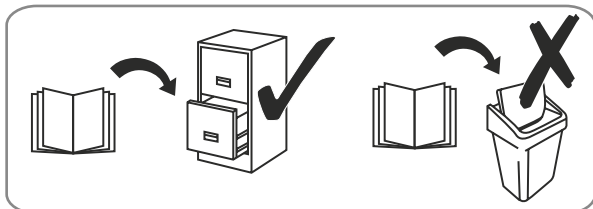
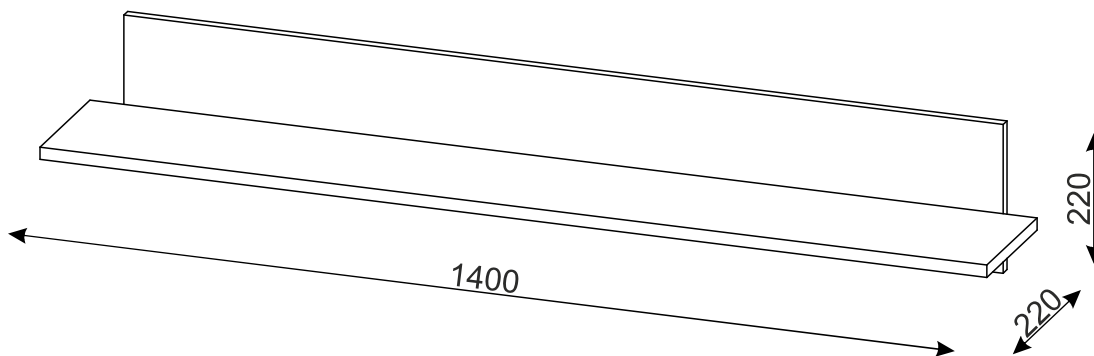
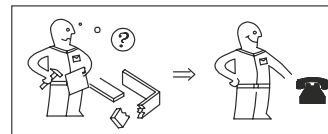
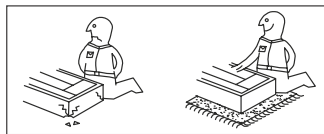
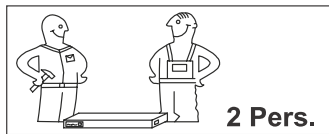
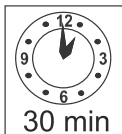

**Wichtig - Für spätere Verwendung
 aufbewahren - sorgfältig lesen!**

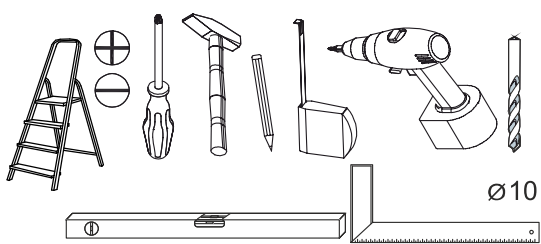

festziehen / tighten / Затягнeтe /
 serrer / stringere / utåhnut / vasttrekken /
 zategnuti / sřángere / zwiázac / zacišnac /
 szorosan meghúzni / pevne dotiahnut /
 trdno pritegniti / затянуть / dra át



eindrücken / press in / enfoncer / wcisnac /
 ribattere / zatačit / Вкарáйтe / indrukken
 benyomni / sílácit / vtisniti / tryck in
 introducere prin apăsare / вдáвить



ausmessen / measure / mesurer /
 misurare / ometen / izmeriti / miara /
 kimériti / izmereti / măsurare / измерить
 zméřit / Измеретe / mät upp / zmierzyc



drücken / press / presser / stisknout /
 Натиснeтe / vtisniti / nasinac / drukken /
 pritisnuti / nacisnac / pritisniti / нажать /
 (meg)nyomni / apăsare / tryck fast / nacisnac



einschlagen / hammer in / beverní / slå in
 frapper au marteau / infossare / Zabit' /
 zarazit / Набáйтe / zabiti / wbić
 introducere prin bátaie / забить / zatlouct



Drehen - wenden / przekręcić - odwrócić /
 Keren - omdraaien / Girare - Ruotare /
 Okrenuti - ubrnuti / Retourner - renverser /
 Turn over - turn around / Otočte - obratite /
 Завернeтe - обáврнeтe / Obrnite list /
 întoarceți - rotiți / Vrid runt - vänd /
 прокрутить - повернуть / otočit - obrátit
 elforgatni - megfordítani

LKZ: XO105

Modellname / Model name / Nom du modèle / Modellnamn
Nome modello / Název modelu / Modelnaam / Ime modela
Número Modelo / Modell neve / Название модели /
Názov modelu / Ime modela / Denumire model /
Наименование на модела / Nazwa modelu

FRENO

Modellnummer / Number / Numéro du modèle
Numero / Номер на модела / modello
Číslo modelu / Modell száma / Éíslo modelu
Številka modela / Numár model / Broj modela
Modelnummer / Numer modelu

X30 A2 T50

Type / Tipo / Típus / Typ / Тип / Tip

T50

01.12.2021

D Unser Direktservice für Beschädigte
Sollte Ihnen ein Beschädigteil fehlen, können Sie diese Servicekarte
direkt an die untenstehende Adresse mailen. Wir können allerdings
nur Beschädigte auf diesem Wege verschicken. Sollten Sie eine
andere Beanstandung an Ihrem Möbelstück haben, so wenden sie
sich bitte direkt an Ihr Möbelhaus.

GB Our direct order service for fitting
If a fitting part is missing, you can e-mail this service card directly
to the address below. However, we can only send fitting parts in
this way. If you have any other cause for complaint concerning
your item of furniture, please contact your furniture store directly.

CZ Naše přímé služby pro kování
Chybí-li vám nějaký díl z kování, můžete tuto servisní kartu odeslat
e-mailem přímo na níže uvedenou adresu. Touto cestou však
můžeme rozesílat jen díly kování. Pokud byste reklamovali jiný díl
nábytku, obraťte se přímo na svého prodejce nábytku.

F Rien étudier la notice de montage
S'il vous manque une ferrure, veuillez envoyer directement la présente
carte service à l'adresse e-mail indiquée ci-dessous. Cependant, ceci
nous permet uniquement d'envoyer des ferrures. Pour tout autre type
de réclamation concernant votre meuble, veuillez contacter
directement votre magasin d'ameublement.

I Il nostro servizio diretto per l'ordine della ferramenta
Qualora Vi dovesse mancare un pezzo di fissaggio, allora Vi
preghiamo di inviare questa carta di servizio immediatamente
all'indirizzo sottostante. Possiamo inviare i pezzi di fissaggio
solamente per mezzo di questo procedimento. Qualora dovreste
avere qualche altra reclamazione in merito al mobile, allora Vi
preghiamo di rivolgervi direttamente al Vostro Negozio di mobili.

BG Нашата директна услуга за обкоя
Ако липсват части от комплекта, попълнете настоящата
сервисна карта и ни я изпратете на e-mail адреса, посочен
по-долу. По този начин можем да доставяме само липсващи
елементи от обкоя. Ако установите други дефекти по
мебелите, Ви съветваме да се обърнете към мебелната
къща/магазин, от който сте закупили стоката.

NL Wanneer er een onderdeel ontbreekt, kunt u deze servicekaart
direct aan onderstaand e-mailadres sturen. Wij kunnen langs deze
weg echter alleen beslagdelen versturen. Mocht u een ander
probleem aan uw meubel hebben, verzoeken wij u contact op te
nemen met uw meubeldealer.

PL Nasz bezpośredni serwis czeski montazowych
Jeżeli brakuje części koniecznych do montażu, prosimy o przesłanie
nam niniejszej karty serwisowej na niżej podany adres e-mailowy.
W ten sposób możemy przelać Państwu tylko brakujące części.
W przypadku innych reklamacji dotyczących mebla, prosimy zgłosić
się do salonu meblowego, w którym został dokonany zakup.

HR Servis za okova
U slučaju da nedostaje neki od dijelova molimo vas da na dolje
navedenu mail adresu pošaljete ovaj servisni obrazac. Na ovaj način
mogu se dostaviti samo okovi. U slučaju da imate dodatne prigovore
vezane uz komad namještaja molimo vas da se obratite izravno
trgovini namještaja gdje je isti kupljen.

HU Direktszolgalatunk vasalatoj esetén
Ha hiányzik egy vasalat, ezt a kártyát közvetlenül elküldheti az
alább található címre. Azonban csak vasalatokat tudunk így
küldeni. Amennyiben másfajta reklamáció áll fenn bútordarabját
illetően, forduljon közvetlenül a bútortárházhoz.

SK Naš priamy servis pre časti kovania
Ak by Vám chýbala nejaká časť kovania, môžete poslať
túto servisnú kartu poslať e-mailom na nižšie uvedenú
adresu. Diely kovania vieme poslať iba týmto spôsobom.
Ak by ste mali inú reklamáciu ohľadom Vášho nábytku,
obráťte sa priamo na Vašu predajňu nábytku.

SLO Naše direktne uslužne storitve za okovje
Če vam manjka kakšno okovje, lahko to servisno kartico pošljete
po e-pošti direktno na spodnji naslov. Po tej poti vam lahko
pošljemo samo okovje. Če želite reklamirati kakšen drug del
pohištva, se obrnite neposredno na vašo trgovino pohištva.

RO Service-ul nostru direct pentru feronerie
În cazul în care vă lipsește o piesă de feronerie puteți să trimiteți
direct acest card de service prin e-mail la adresa de mai jos. Noi
nu putem expedia piese de feronerie decât pe această cale.
Dacă aveți o altă reclamație referitoare la piesa de mobilier,
atunci vă rugăm să vă adresați direct la magazinul dvs. de mobilă.

RUS Наш прямой сервис для поставок фурнитуры
Если окажется, что Вам не хватает того или иного элемента
фурнитуры, Вы можете отправить сервисную карту по факсу
непосредственно на нижеприведенный адрес электронной
почты. Однако, таким образом мы можем переслать лишь
фурнитуру. Если же у Вас возникнут иные претензии относительно
приобретенной мебели, пожалуйста, обращайтесь
непосредственно в организацию, осуществляющую продажу.

S Vår direktservice för beslagsdelar
Om du saknar en beslagsdel kan du skicka detta servicekort direkt
till e-postadressen som anges nedan. Tank på att detta är den enda
möjligheten att skicka beslagsdelar till dig. Om du vill reklamera din
möbel av en annan anledning måste du kontakta ditt möbels hus direkt.

ES Nuestro servicio directo para accesorios
Si le falta algún accesorio, puede enviar esta tarjeta de servicio directamente
a la siguiente dirección. No obstante, por este método solo podemos
enviar accesorios. Si tiene alguna otra objeción sobre su mueble, consulte
directamente con su mueblería.

TR Donatılar için doğrudan servisimiz
Bir donatınız eksikse bu servis kartını doğrudan aşağıda bulunan adrese
doğrudan mail yazabilirsiniz. Sadece bu yolla donatıları gönderebiliriz.
Mobilyanızda başka şikayetleriniz varsa lütfen doğrudan mobilya satıcınıza
danışın.

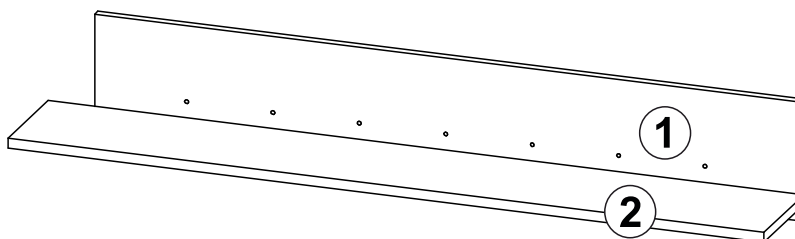
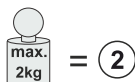

Nr.	Maße mm			Colli	Anzahl
1	1300	220	16	1/1	1
2	1400	204	16	1/1	1
B1				1/1	1

Grund der Beanstandung / Reason of the objection:

Möbelhaus / Furniture store:

Name / Name: Telefon / Telephone:

PLZ / postal code: Ort / City:

Strasse / Street:

Haus-Nr. / House No.: @E-Mail:

E-Mail Kundenservice / Customer service e-mail / E-mail servisního střediska / E-mail de notre service clientèle / e-mail servizio clienti / E-mail na отдела за
обслужване на клиенти / E-mail klantenservice / E-mail servisu dla klientów / Servisna mail adresa / Az ügyfélszolgálat e-mail címe / E-mail zákaznického
servisu / E-pošta Servisna služba / E-mail Serviciu clienți / E-Mail сервисной службы / E-postadress kundservice / Servicio de atención por correo electrónico / Müşteri hizmetleri e-postası

service@xonox-home.com
Hotline xonox.home GmbH
0049-(0)5261-92020800

LKZ: X0105

Modellname / Model name / Nom du modèle / Modellnamn
 Nome modello / Název modelu / Modelnaam / Ime modela
 Numéro Modello / Modell neve / Название модели /
 Názov modelu / Ime modela / Denumire model /
 Наименование на модела / Nazwa modelu

FRENO

Modellnummer / Number / Numéro du modèle
 Numero / Номер на модела / modello
 Číslo modelu / Modell száma / Éislo modelu
 Številka modela / Număr model / Broj modela
 Modelnummer / Numer modelu





X30 A2 T50

Type / Tipo / Típus / Тип / Тип / Tip

T50

01.12.2021

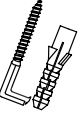
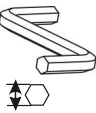
B1 (COLLI 1/1)

B0	B2	D22	E3	K	P1	U0
						
	Ø7x70	5x11	10x50	4mm		
x7	x7	x4	x2	x1	x2	x2

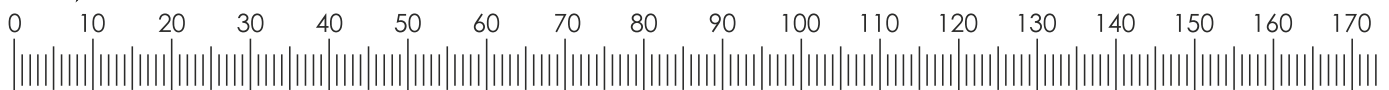
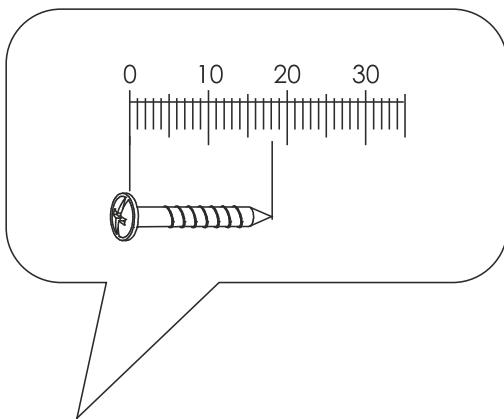

1

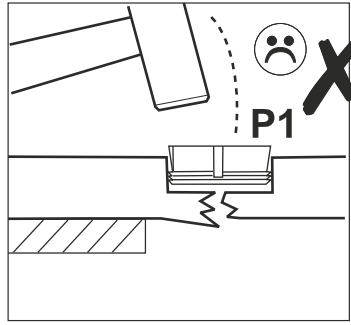
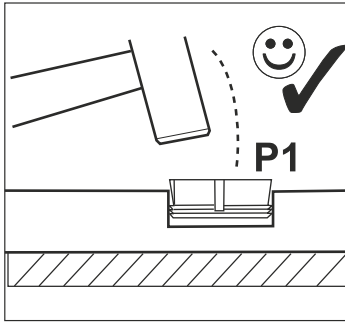

D22

5x11
x4

P1

x2

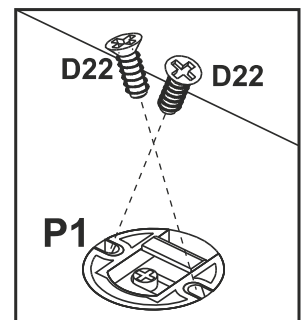
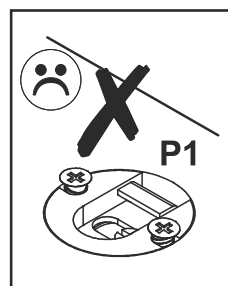
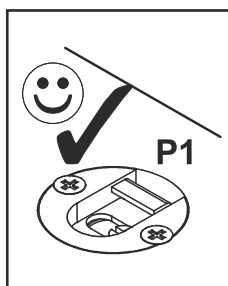
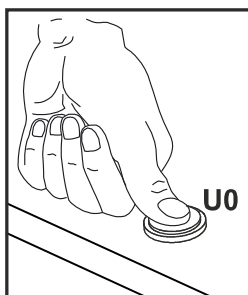
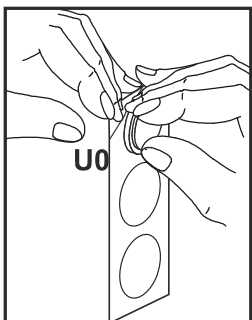
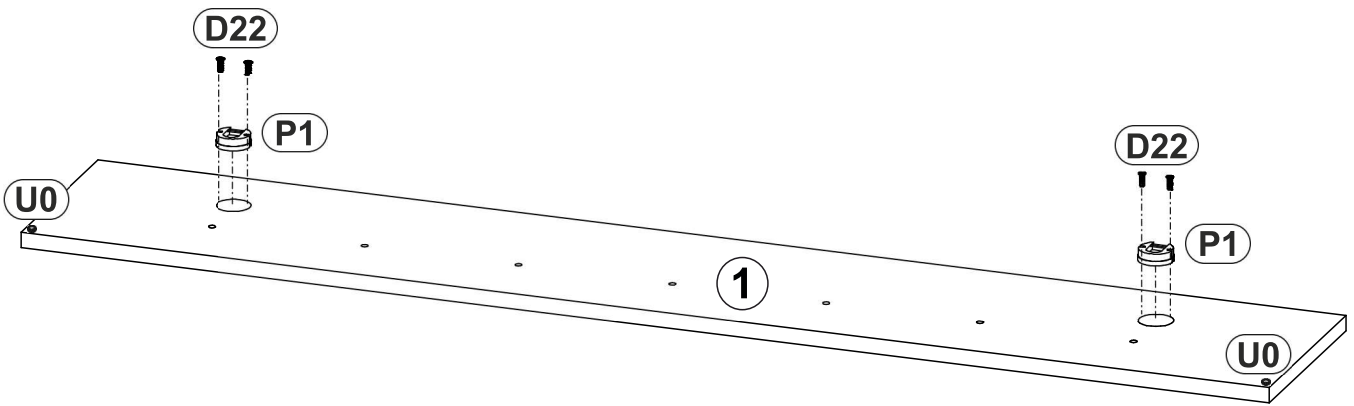
U0

x2

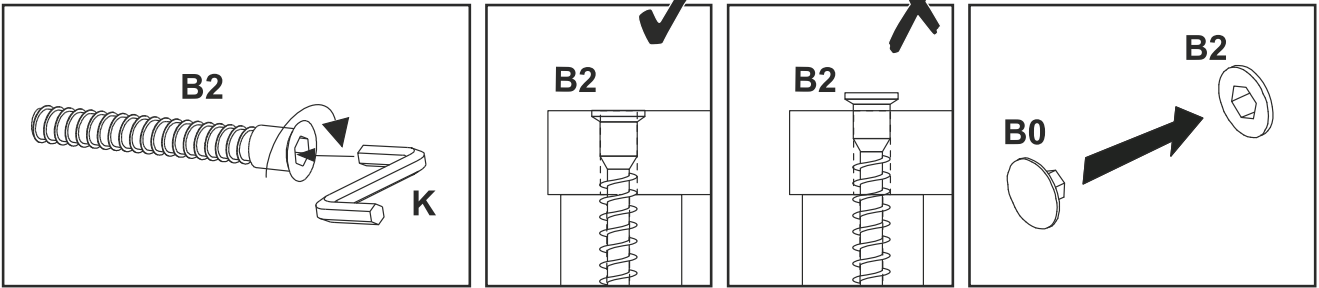
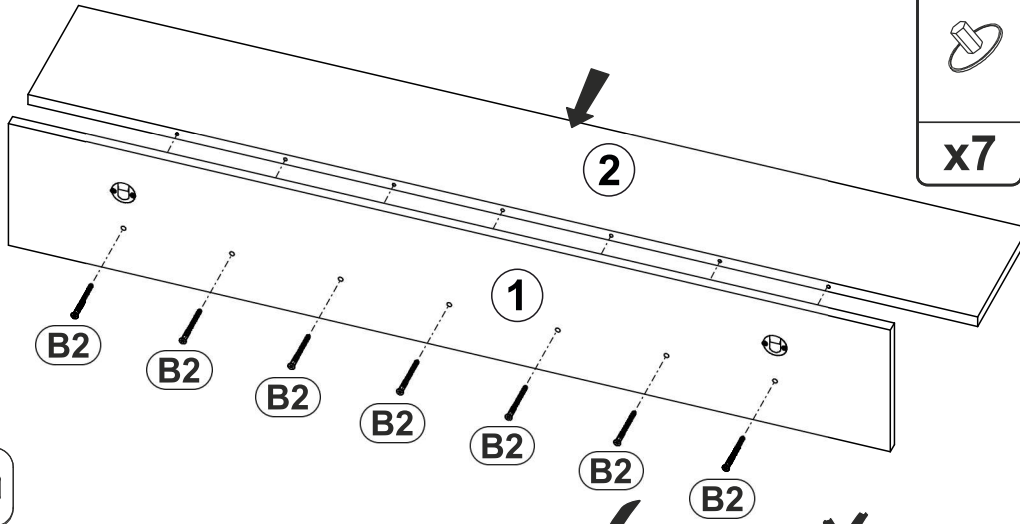

2

B0	B2	K
x7	$\text{Ø}7 \times 70$	4mm
	x7	x1



3

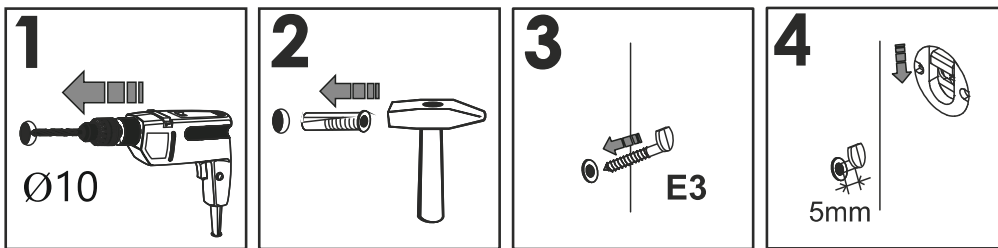

E3
10x50
x2

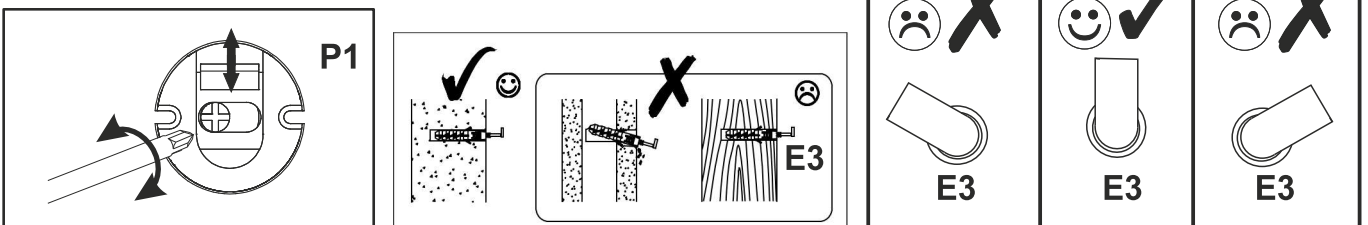
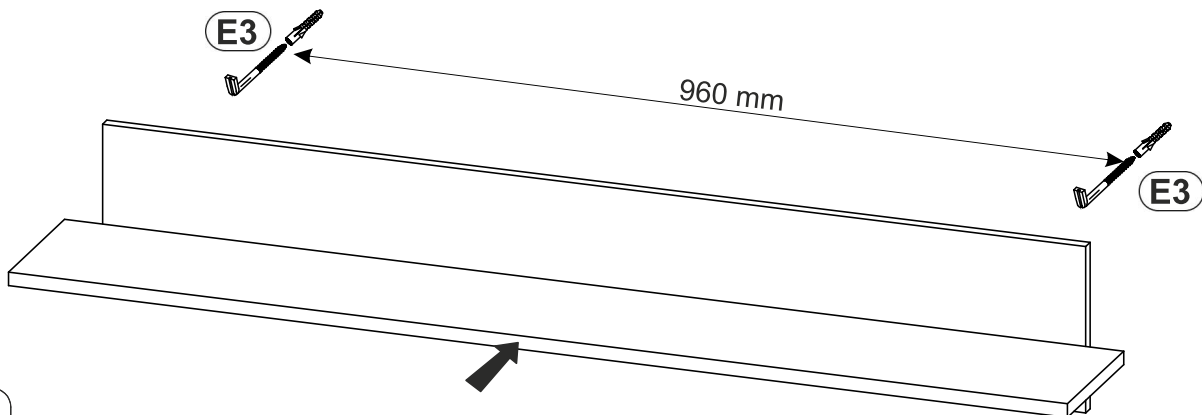

LKZ: X0105

Modellname / Model name / Nom du modèle / Modellnamn
 Nome modello / Název modelu / Modelnaam / Ime modela
 Numéro Modelo / Modell neve / Название модели /
 Názov modelu / Ime modela / Denumire model /
 Наименование на модела / Nazwa modelu

FRENO

Modellnummer / Number / Numéro du modèle
 Numero / Номер на модела / modello
 Číslo modelu / Modell száma / Éislo modelu
 Številka modela / Număr model / Broj modela
 Modelnummer / Numer modelu

X30 A2 T21

Type / Tipo / Típus / Typ / Тип / Tip

T21

22.11.2021

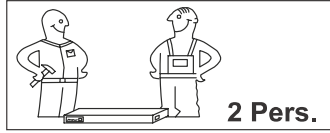

2 Pers.

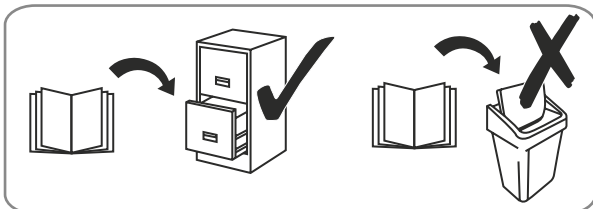
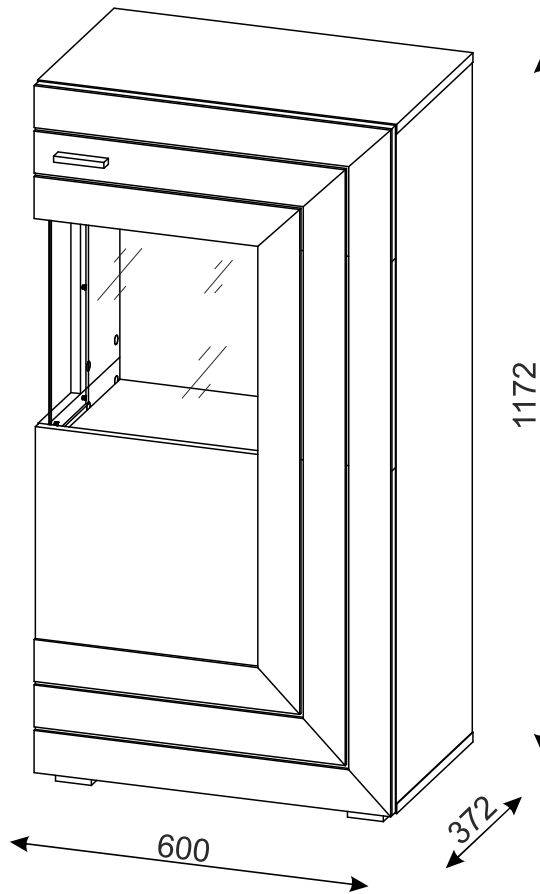
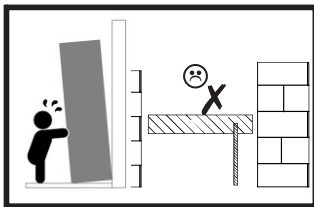
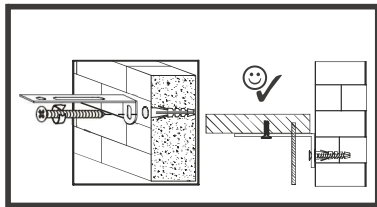
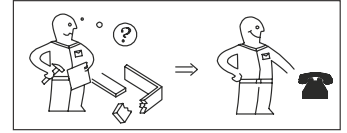
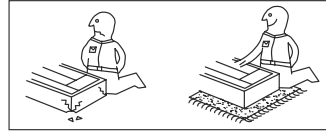

**Wichtig - Für spätere Verwendung
 aufbewahren - sorgfältig lesen!**

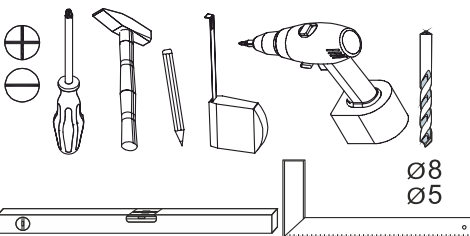

2 Pers.



60 min



festziehen / tighten / Затягнете /
 serrer / stringere / utåhntout / vasttrekken /
 zategnuti / strängere / związac / zacisnąć
 szorosan meghúzni / pevne dotiahnut /
 trdno pritegniti / затянуть / dra át



eindrücken / press in / enfoncer / wcisnąć
 ribattere / zatlačit / Вкарайте / Indrukken
 benyomni / silăciť / vtisniť / tryck in
 introducere prin apăşare / вдавить



ausmessen / measure / mesurer /
 misurare / opmeten / izmeriti / miara /
 kimérni / izmeriti / măsurare / измерить
 změřit / Измерете / mät upp / zmierzyc



drücken / press / presser / stisknout /
 Натиснете / vtisniť / nasinac / drukken /
 pritisnuti / nacisnac / pritisniti / нажать /
 (meg)nyomni / apăşare / tryck fast / nacisnąć



einschlagen / hammer in / beverni / slå in
 frapper au marteau / infossare / Zabit' /
 zarazit / Набийте / zabiti / wbić
 introduce prin bătaie / забить / zaľouct



Drehen - wenden / przekrećić - odwrócić /
 Keren - omdraaien / Girare - Ruotare /
 Okrenuti - ubnuti / Retourner - renverser /
 Turn over - turn around / Otocte - obratite /
 Zавърте - обърнете / Obrnite list /
 Întoarceţi - rotiţi / Vrid runt - vänd /
 прокрутите - поверните / otočit - obrátit
 elforgatni - megfordítani

LKZ: X0105

Modellname / Model name / Nom du modèle / Modellnamn
Nome modello / Název modelu / Modelnaam / Ime modela
Número Modelo / Modell neve / Название модели /
Názov modelu / Ime modela / Denumire model /
Наименование на модела / Nazwa modelu

FRENO

Modellnummer / Number / Numéro du modèle
Numero / Номер на модела / modello
Číslo modelu / Modell száma / Éislo modelu
Številka modela / Număr model / Broj modela
Modelnummer / Numer modelu

X30 A2 T21

Type / Tipo / Típus / Typ / Тип / Tip

T21

22.11.2021

D Unser Direktservice für Beschlagteile
Sollte Ihnen ein Beschlagteil fehlen, können Sie diese Servicekarte direkt an die untenstehende Adresse mailen. Wir können allerdings nur Beschlagteile auf diesem Wege verschicken. Sollten Sie eine andere Beanstandung an Ihrem Möbelstück haben, so wenden Sie sich bitte direkt an Ihr Möbelhaus.

GB Our direct order service for fitting
If a fitting part is missing, you can e-mail this service card directly to the address below. However, we can only send fitting parts in this way. If you have any other cause for complaint concerning your item of furniture, please contact your furniture store directly.

CZ Naše přímé služby pro kování
Chybí-li vám nějaký díl z kování, můžete tuto servisní kartu odeslat e-mailem přímo na níže uvedenou adresu. Touto cestou však můžeme zoslat jen díly kování. Pokud byste reklamovali jiný díl nábytku, obraťte se přímo na svého prodejce nábytku.

F Bien étudier la notice de montage
S'il vous manque une ferrure, veuillez envoyer directement la présente carte service à l'adresse e-mail indiquée ci-dessous. Cependant, ceci nous permet uniquement d'envoyer des ferrures. Pour tout autre type de réclamation concernant votre meuble, veuillez contacter directement votre magasin d'ameublement.

I Il nostro servizio diretto per l'ordine della ferramenta
Qualora Vi dovesse mancare un pezzo di fissaggio, allora Vi preghiamo di inviare questa carta di servizio immediatamente all'indirizzo sottostante. Possiamo inviare i pezzi di fissaggio solamente per mezzo di questo procedimento. Qualora dovesse avere qualche altra reclamazione in merito al mobile, allora Vi preghiamo di rivolgerVi direttamente al Vostro Negozio di mobili.

BG Нашата директна услуга за обков
Ако липсват части от комплекта, попълнете настоящата сервисна карта и ни я изпратете на e-mail адреса, посочен по-долу. По този начин можем да доставим само липсващи елементи от обкова. Ако установите други дефекти по мебелите, Ви съветваме да се обърнете към мебелната къща/магазин, от който сте закупили стоката.

NL Onze directservice voor losse onderdelen
Wanneer er een onderdeel ontbreekt, kunt u deze servicekaart direct aan onderstaand e-mailadres sturen. Wij kunnen langs deze weg echter alleen beslagdelen versturen. Mocht u een ander probleem aan uw meubel hebben, verzoeken wij u contact op te nemen met uw meubeldealer.

PL Nasz bezpośredni serwis czeski montażowych
Jeżeli brakuje części koniecznych do montażu, prosimy o przesłanie nam niniejszej karty serwisowej na niżej podany adres e-mailowy. W ten sposób możemy przesłać Państwu tylko brakujące części. W przypadku innych reklamacji dotyczących mebla, prosimy zgłosić się do salonu meblowego, w którym zostały dokonany zakup.

HR Servis za okove
U slučaju da nedostaje neki od dijelova molimo vas da na dolje navedenu mail adresu pošaljete ovaj servisni obrazac. Na ovaj način mogu se dostaviti samo okovi. U slučaju da imate dodatne prigovore vezane uz komad namještaja molimo vas da se obratite izravno trgovini namještaja gdje je isti kupljen.

HU Direktszolgálatunk vasalatók esetén
Ha hiányzik egy vasalat, ezt a kártyát közvetlenül elküldheti az alább található címre. Azonban csakis vasalatókat tudunk így küldeni. Amennyiben másfajta reklamáció áll fenn bútordarabját illetően, forduljon közvetlenül a bútortárházhoz.

SK Naš priamy servis pre časti kovania
Ak by Vám chýbala nejaká časť kovania, môžete poslať túto servisnú kartu poslať e-mailom na nižšie uvedenú adresu. Diely kovania vieme poslať iba týmto spôsobom. Ak by ste mali inú reklamáciu ohľadom Vašho nábytku, obráťte sa priamo na Vašu predajňu nábytku.

SLO Naše direktno uslužne storitve za okovje
Če vam manjka kakšno okovje, lahko to servisno kartico pošljete po e-pošti direktno na spodnji naslov. Po tej poti vam lahko pošljemo samo okovje. Če želite reklamirati kakšen drug del pohištva, se obmite neposredno na vašo trgovino pohištva.

RO Service-ul nostru direct pentru feronerie
În cazul în care vă lipsește o piesă de feronerie puteți să trimiteți direct acest card de service prin e-mail la adresa de mai jos. Noi nu putem expedia piese de feronerie decât pe această cale. Dacă aveți o altă reclamație referitoare la piesa de mobilier, atunci vă rugăm să vă adresați direct la magazinul dvs. de mobilă.

RUS Наш прямой сервис для поставок фурнитуры
Если окажется, что Вам не хватает того или иного элемента фурнитуры, Вы можете отправить сервисную карту по факсу непосредственно на нижеприведенный адрес электронной почты. Однако, таким образом мы можем переслать лишь фурнитуру. Если же у Вас возникнут иные претензии относительно приобретенной мебели, пожалуйста, обращайтесь непосредственно в организацию, осуществившую продажу.

S Vår direktservice för beslagsdelar
Om du saknar en beslagsdel kan du skicka detta servicekort direkt till e-postadressen som anges nedan. Tänk på att detta är den enda möjligheten att skicka beslagsdelar till dig. Om du vill reklamera din möbel av en annan anledning måste du kontakta ditt möbelhus direkt.

ES Nuestro servicio directo para accesorios
Si le falta algún accesorio, puede enviar esta tarjeta de servicio directamente a la siguiente dirección. No obstante, por este método solo podemos enviar accesorios. Si tiene alguna otra objeción sobre su mueble, consulte directamente con su mueblería.

TR Donatılar için doğrudan servisimiz
Bir donatınız eksikse bu servis kartını doğrudan aşağıda bulunan adrese doğrudan mail yazabilirsiniz. Sadece bu yolla donatıları gönderebiliriz. Mobilyanızda başka şikayetleriniz varsa lütfen doğrudan mobilya satıcınıza danışın.

max. 5kg = ⑥

max. 10kg = ① ②

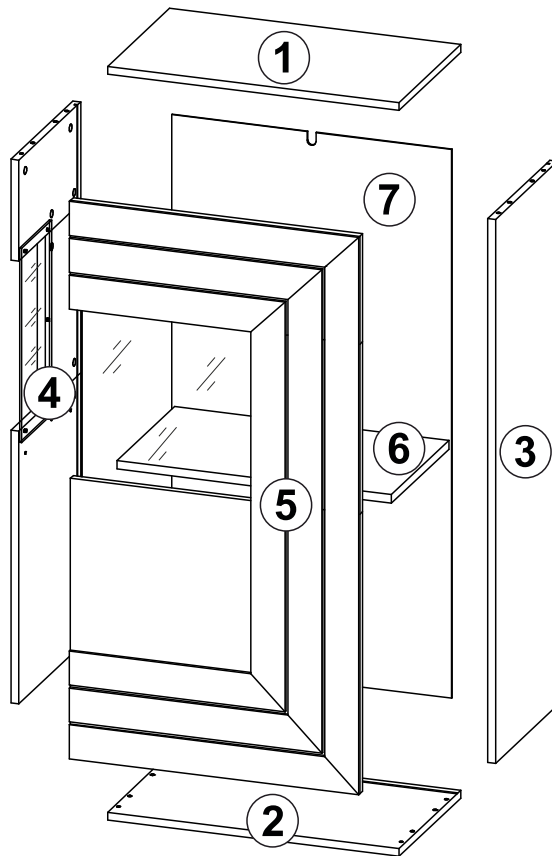

Nr.	Maße mm		Colli	Anzahl
1	600	350	16	1/1 1
2	600	350	16	1/1 1
3	1120	350	16	1/1 1
4	1120	350	20	1/1 1
5	1148	596	26	1/1 1
6	565	320	16	1/1 1
7	1130	576	3	1/1 1
B1				1/1 1

Grund der Beanstandung / Reason of the objection:

Möbelhaus / Furniture store:

Name / Name: Telefon / Telephone:

PLZ / postal code: Ort / City:

Strasse / Street:

Haus-Nr. / House No.: @E-Mail:

E-Mail Kundenservice / Customer service e-mail / E-mail servisního střediska / E-mail de notre service clientèle / e-mail servizio clienti / E-mail на отдела за обслужване на клиенти / E-mail klantenservice / E-mail servisu dla klientów / Servisna mail adresa / Az ügyfélszolgálat e-mail címe / E-mail zákaznického servisu / E-pošta Servisna služba / E-mail Serviciu clienți / E-Mail сервисной службы / E-postadress kundservice / Servicio de atención por correo electrónico / Müşteri hizmetleri e-postası

service@xonox-home.com
Hotline xonox.home GmBH
0049-(0)5261-9202800

LKZ: X0105

Modellname / Model name / Nom du modèle / Modellnamn
Nome modello / Název modelu / Modelnaam / Ime modela
Número Modelo / Modell neve / Название модели /
Názov modelu / Ime modela / Denumire model /
Наименование на модела / Nazwa modelu

FRENO

Modellnummer / Number / Numéro du modèle
Numero / Номер на модела / modello
Číslo modelu / Modell száma / Ěíslo modelu
Številka modela / Numár model / Broj modela
Modelnummer / Numer modelu















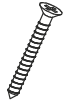
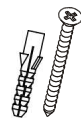

X30 A2 T21

Type / Tipo / Típus / Тип / Тип / Tip

T21

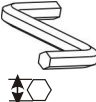
22.11.2021

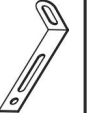
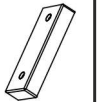
B1 (COLLI 1/1)

A0  Ø8x30 x8	B0  x4	B1  Ø7x50 x4	C0  x20	C2  x4	C7  16 mm x4	D0  3x15 x12	D5  3.5x16 x6	D21  5x13 x1	D37  4x20 x8	E0  8x50 x1
H10  4x30 x2	J45  x3	J56  x3	K  4mm x1	L54  x1	M1  x12	P0  x1	T19  x4	Q0  x4	U0  x2	

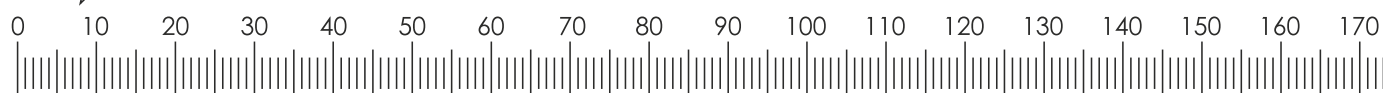
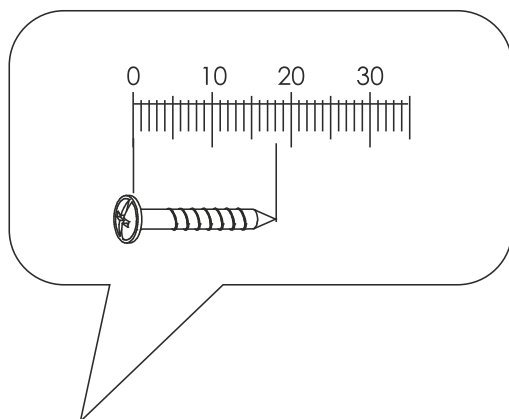

1

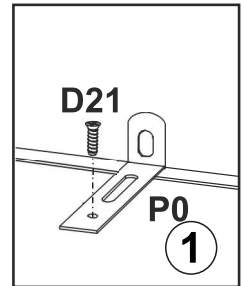
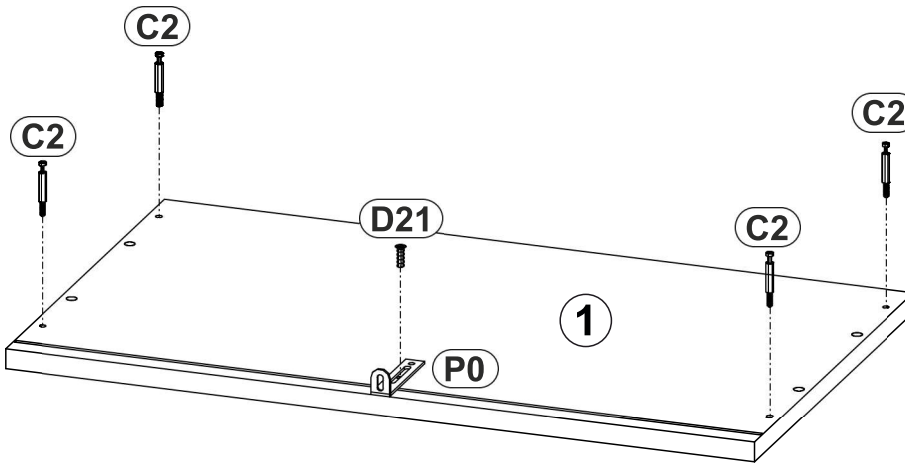
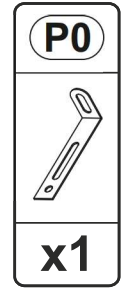
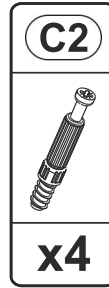
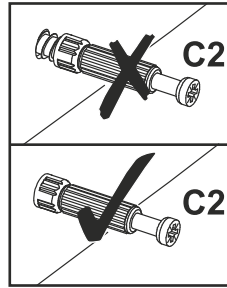
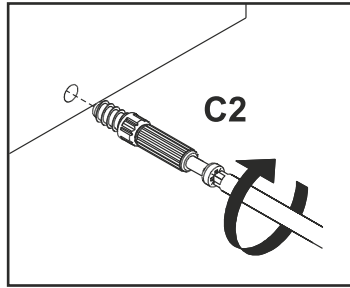



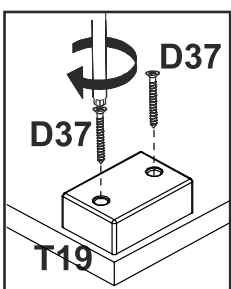
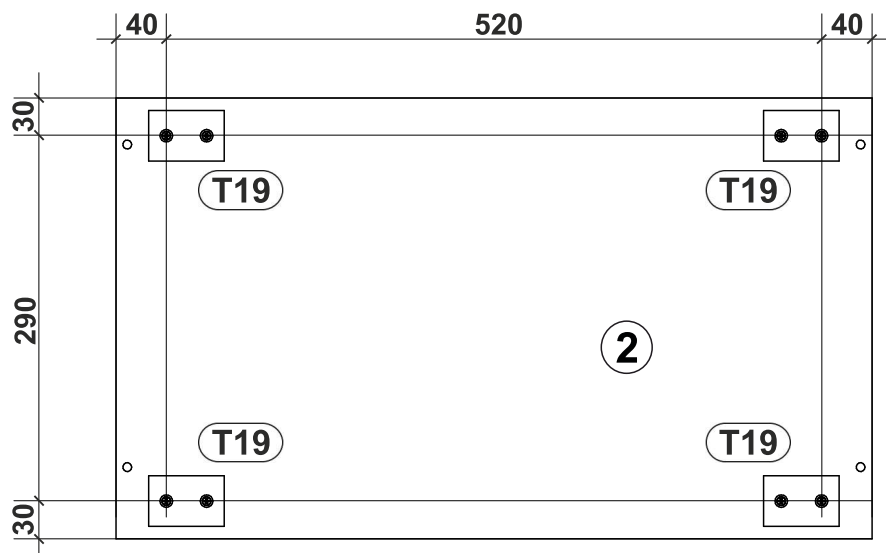
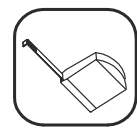
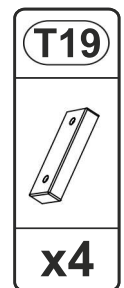
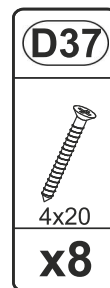
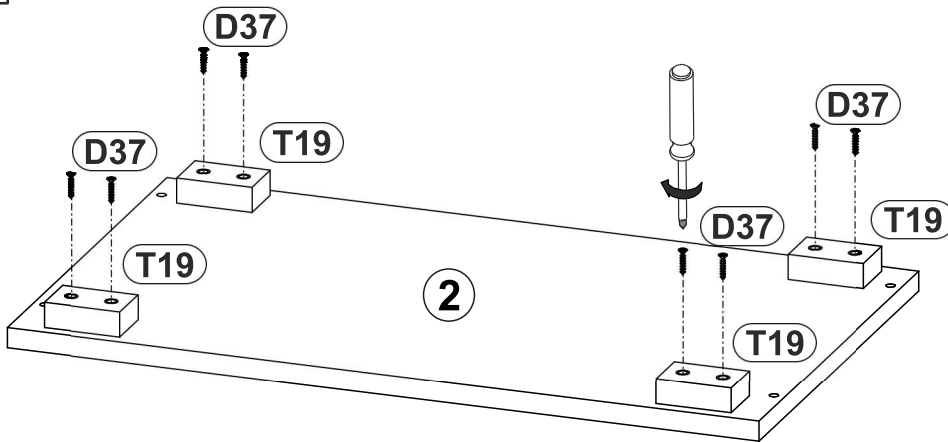

2

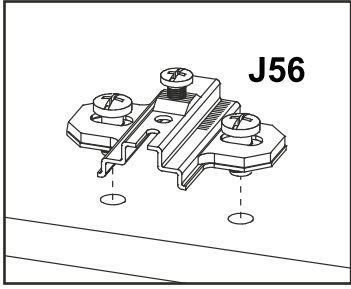

3

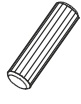

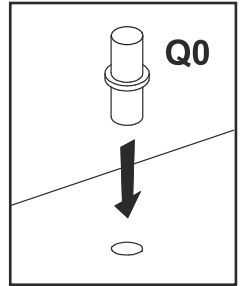
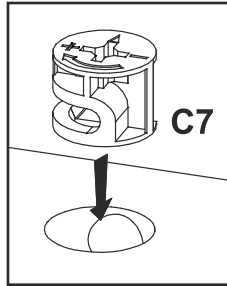
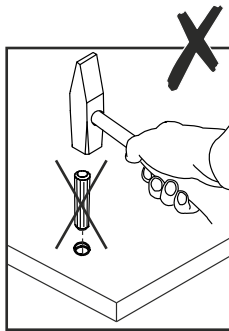
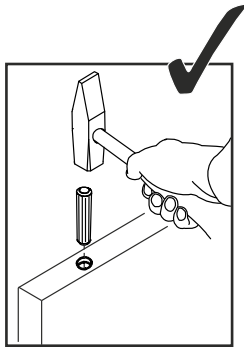
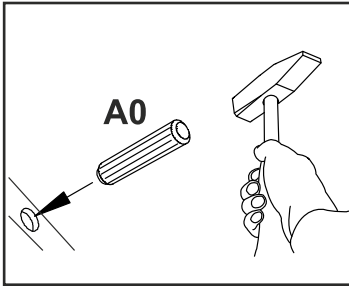
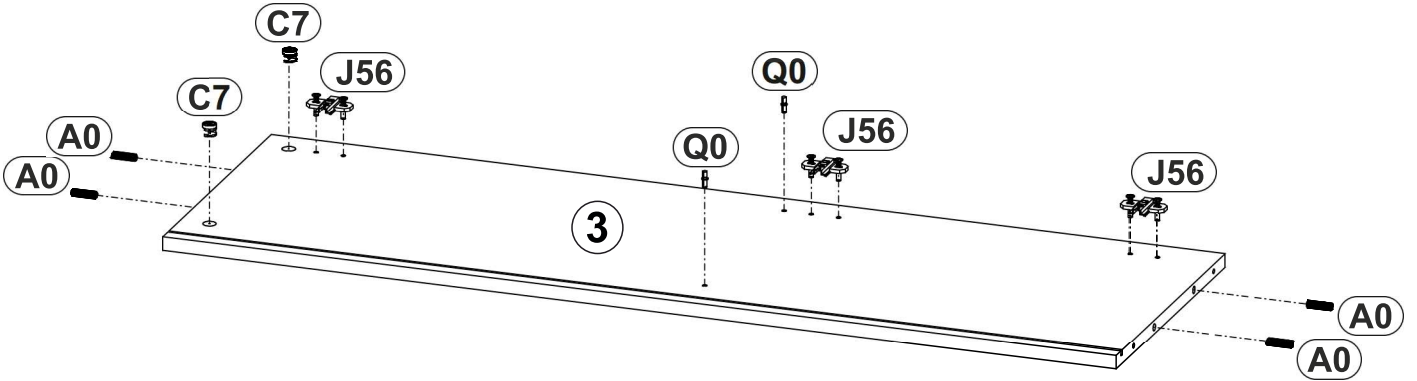

J56

A0	C7	J56	Q0
			
Ø8x30	16 mm		
x4	x2	x3	x2

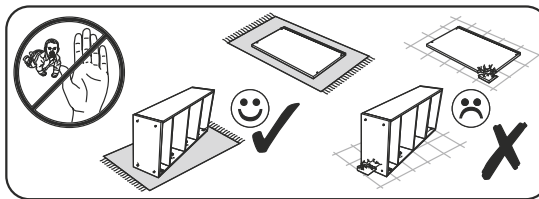
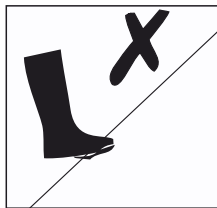

4

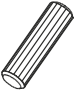



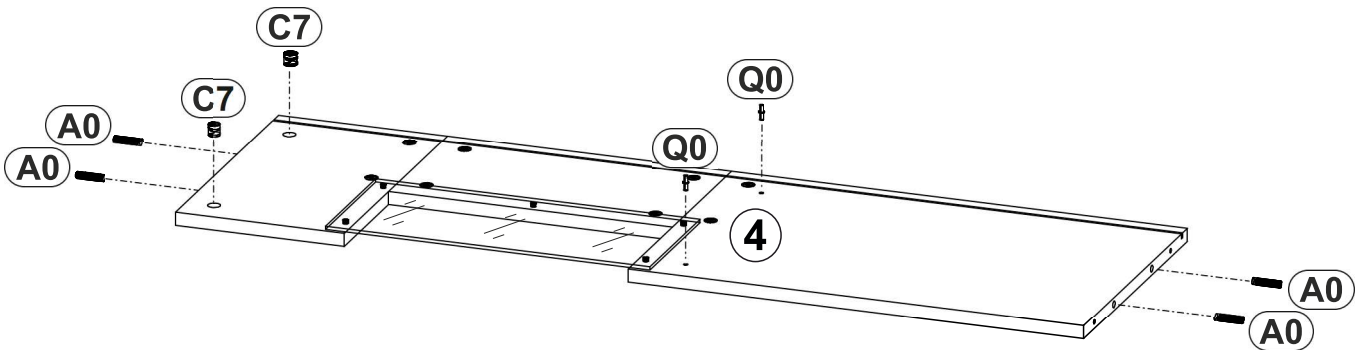

A0	C7	Q0
		
Ø8x30	16 mm	
x4	x2	x2

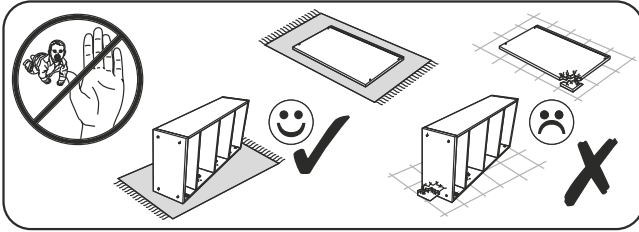

5



D5  3.5x16 x6	H10  4x30 x2	J45  x3	L54  x1	U0  x2
---	--	--	--	---

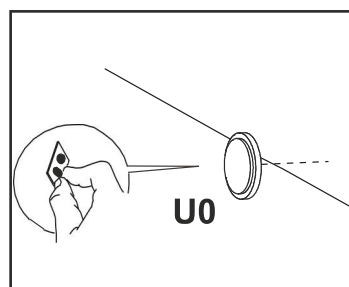
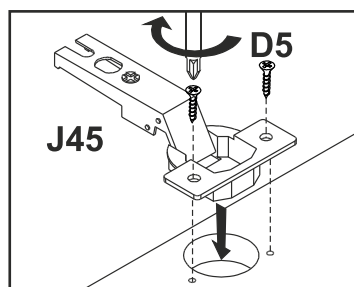
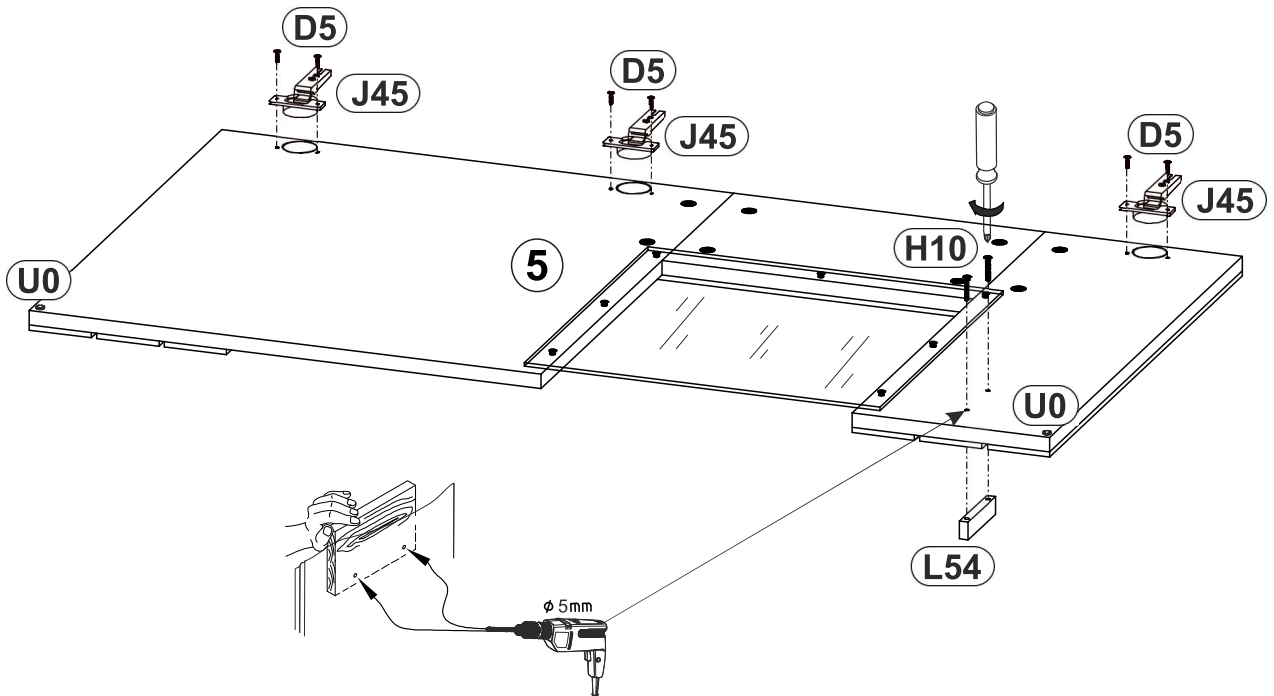
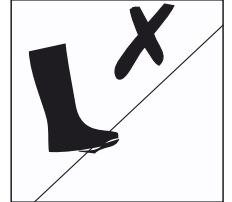

6

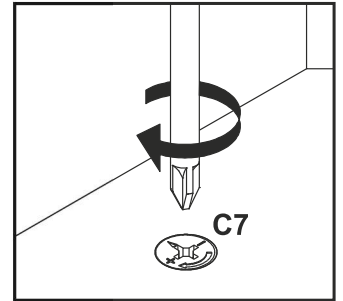
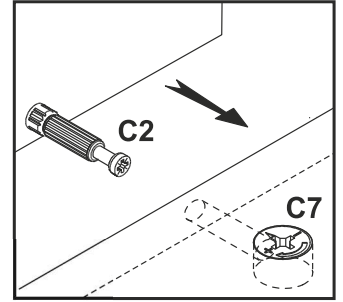
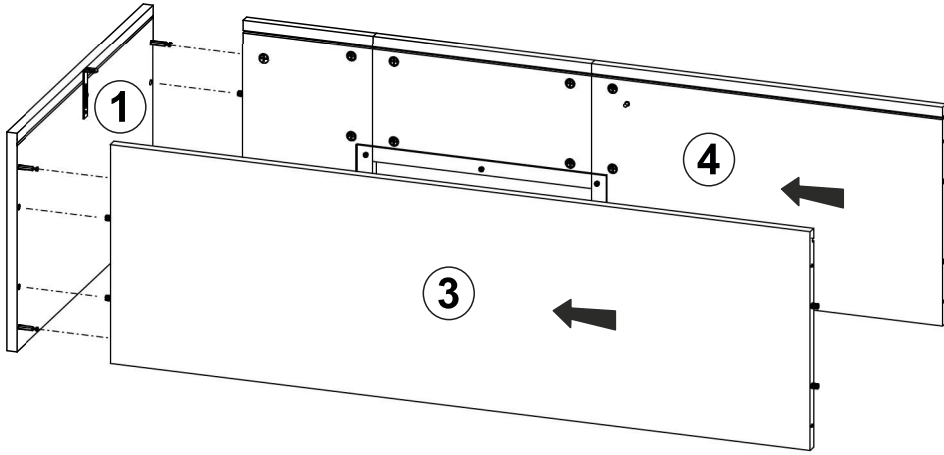

7

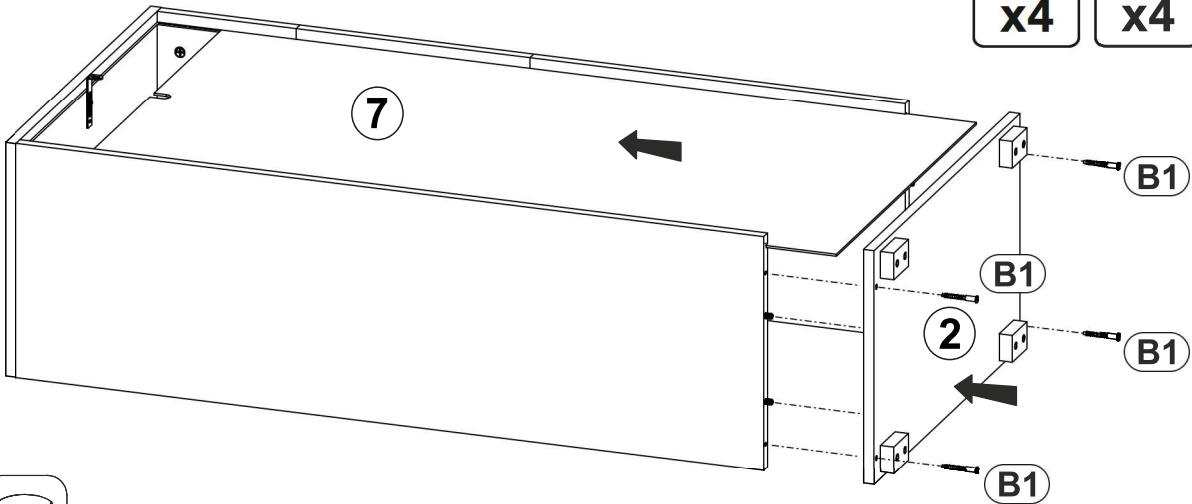

B0	B1	K
x4	$\varnothing 7 \times 50$ x4	4mm x1

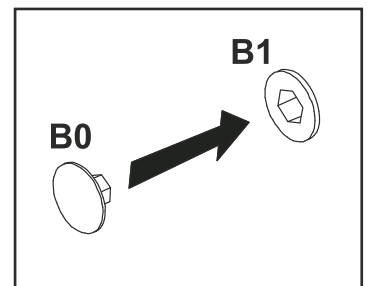
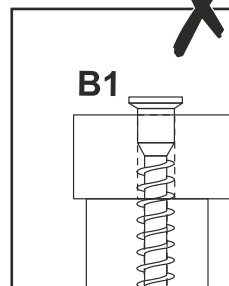
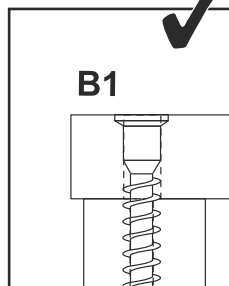
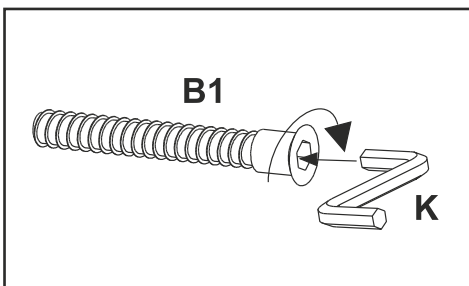

8

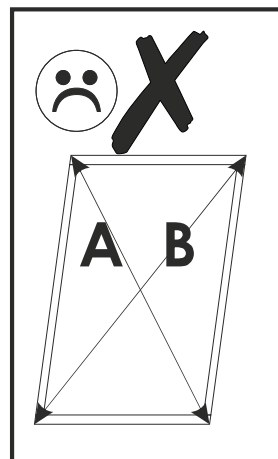
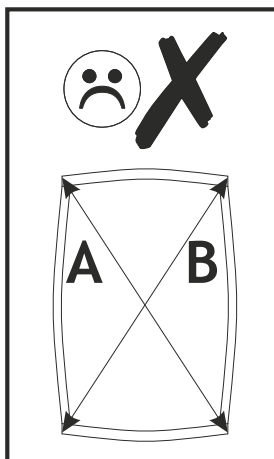
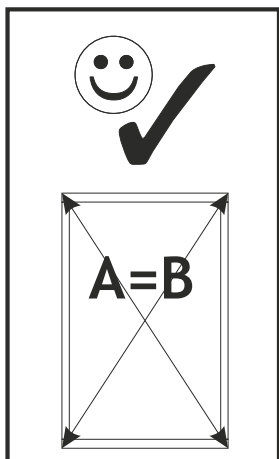
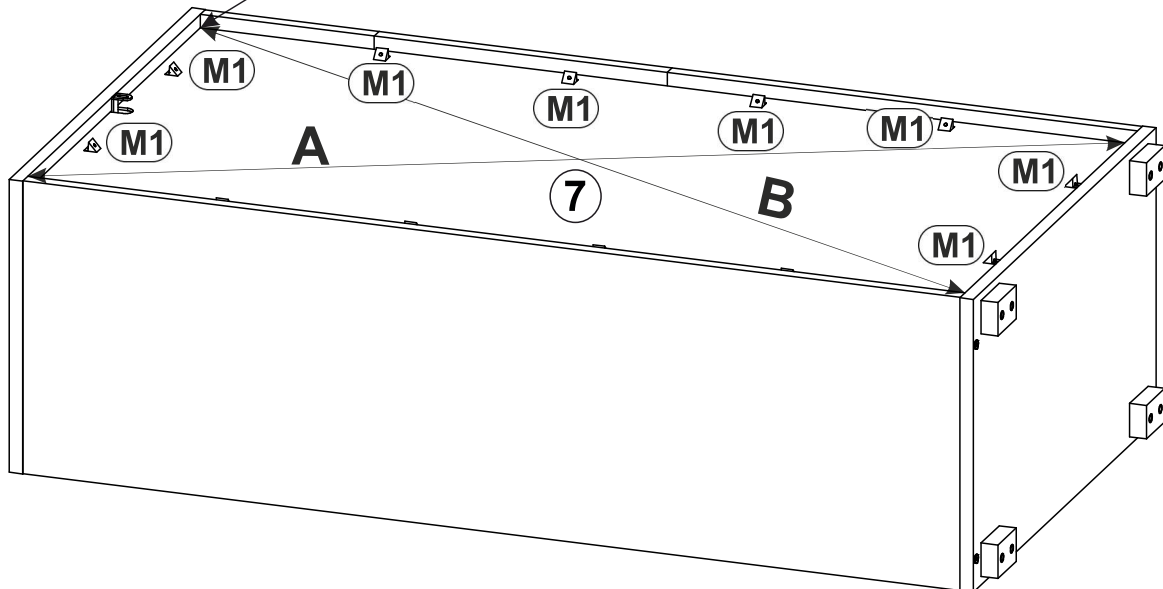
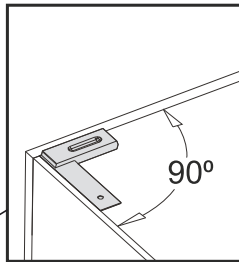
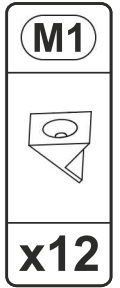
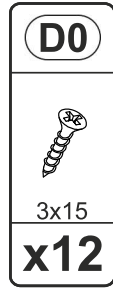
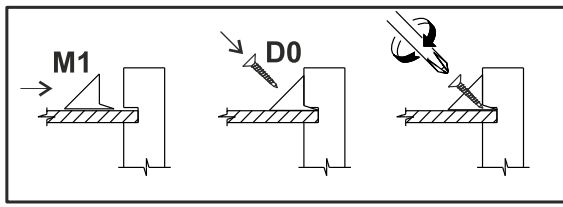
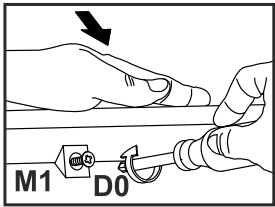

9

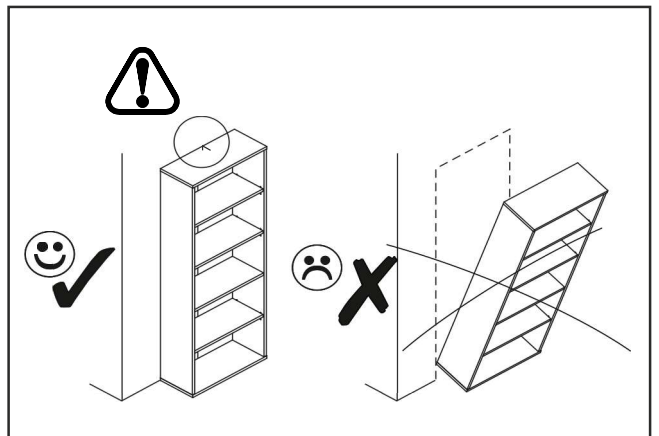
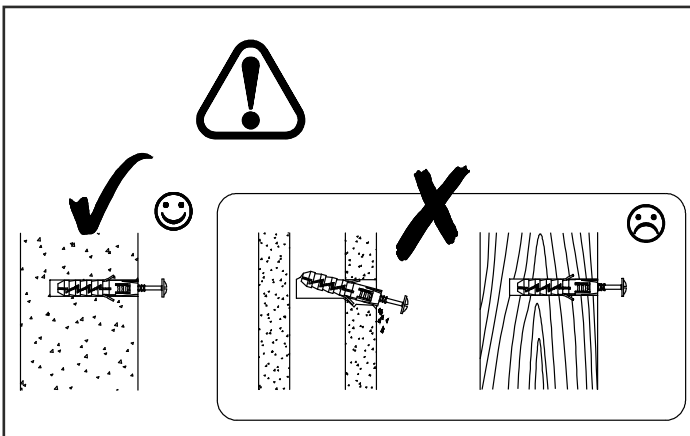
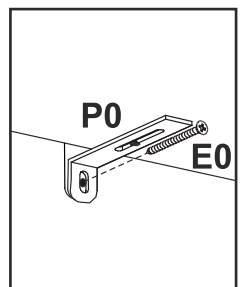
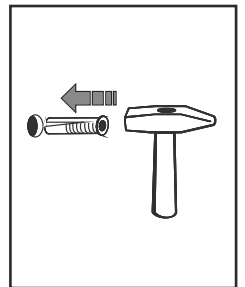
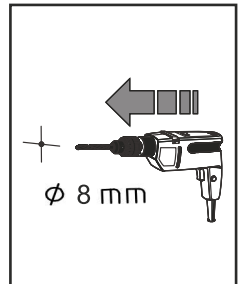
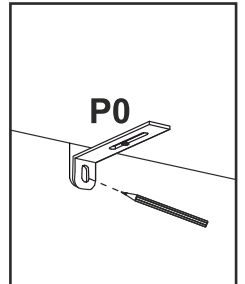
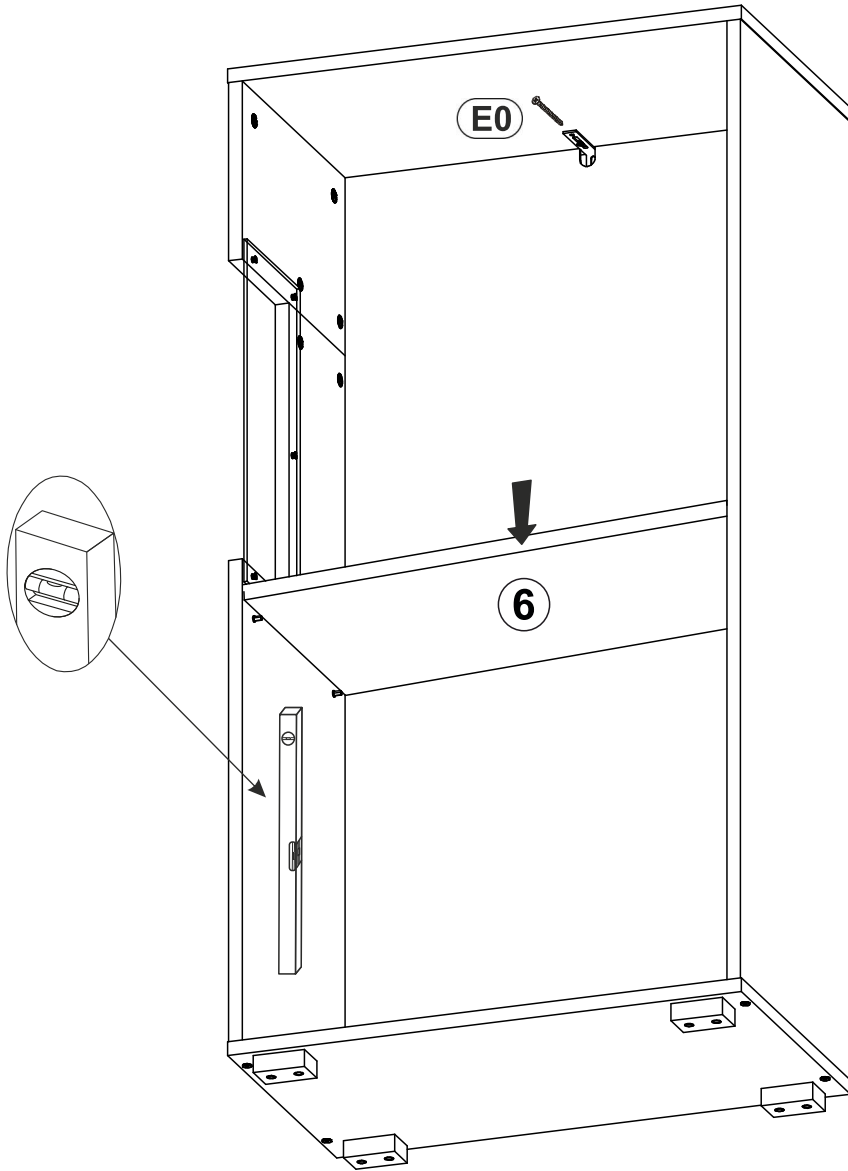
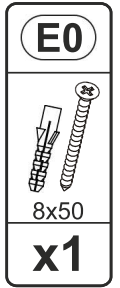
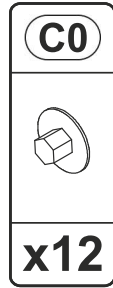
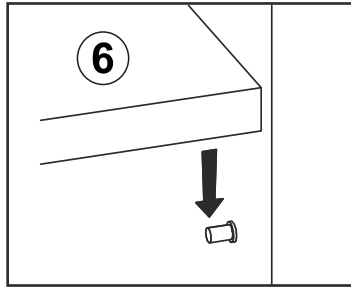
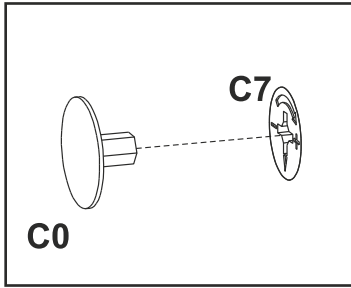

10

C0



x8

