

ULTIMEA

# FULL HD PROJECTOR USER MANUAL

Apollo P20



Model No.: U0321

1080P

## WE ARE READY TO HELP



support@ultimea.com

### Prefer video tutorial?

Setup guidance video  
and User Manuals on  
ULTIMEA website.



support.ultimea.com



@Ultimea\_Official +1 888-598-8875 (US) Mon-Fri 9am-5pm (PST)  
+49 89-628-25828 (EU) Mon-Fri 9am-5pm (CET)

**IMPORTANT:** Before using the projector, please read these set up guide, for more detailed instruction, please go to check the online User Manual. Your product may differ from the illustrations on this sheet, but the instructions are the same.

**Note:** Due to Type-C protocols, android phone/pad can not be played by USB or HD cable connection.

## 1 Accessories List



Apollo P20

Remote  
(Batteries not included)

Quick guide



AV Cable



HD Cable



Power Cable

## 2 Product

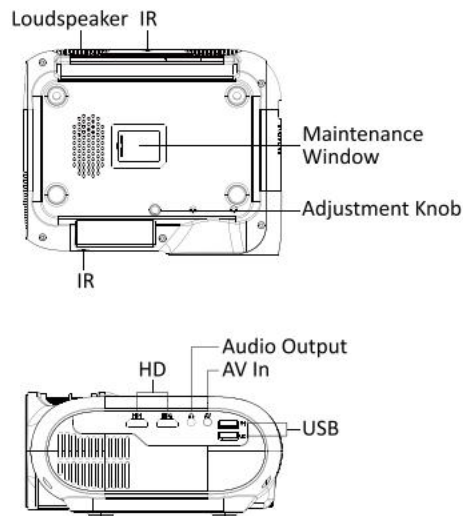
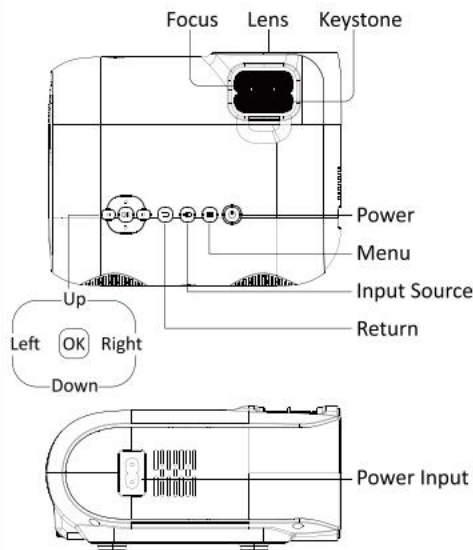

## 3 Remote Control

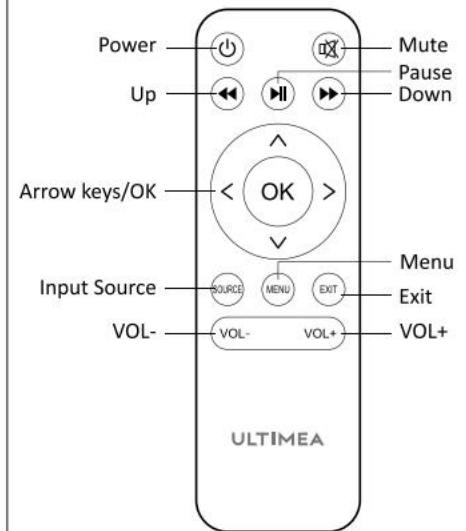

## 4 Quick Setup

### 4.1 Power On / Power Off

Plug in the AC power cord, click the power button on the operation panel of the machine or on the remote control and the projector will start to work.



### 4.2 Projector Installation

You can choose horizontal placement or hanger installation.

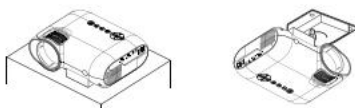

Horizontal placement

Hanger installation

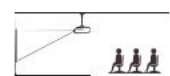

1 Front projection  
ceiling mount

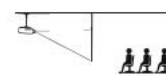

2 Rear projection  
ceiling mount



3 Front projection  
table mount



4 Rear projection  
table mount

The projection screen can be played from 35" to 120". The recommended projection screen is 40" to 80". Ambient darkness will improve the clarity of the projected images.

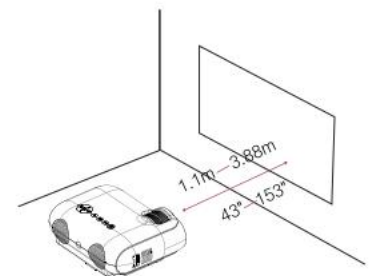

The distance between Apollo P20 and the projection surface must be a minimum of 1.1 meters (43 inches) and maximum of 3.88 meters (153 inches).

## 5 Adjusting the projector image

### 5.1 Please adjust the dial slowly to bring the picture into focus

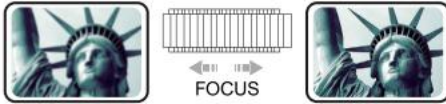

### 5.2 Adjust the Image Projected On the Screen

Check the horizontal and vertical settings of the projector till the image on the screen is balanced.

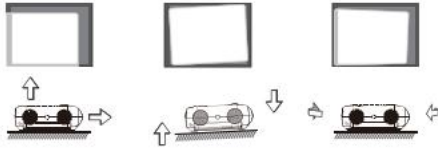

## 6 Keystone correction

1. Adjust the keystone on the projector to adjust the images shape.



2. Adjust the placement of the projector. When the left side of the picture is wider, move the left side of the projector corresponding to the picture forward; when the right side of the picture is wider, move the right side of the projector corresponding to the picture forward.



## 7 Input Source

### 7.1 Wired Connection to Devices

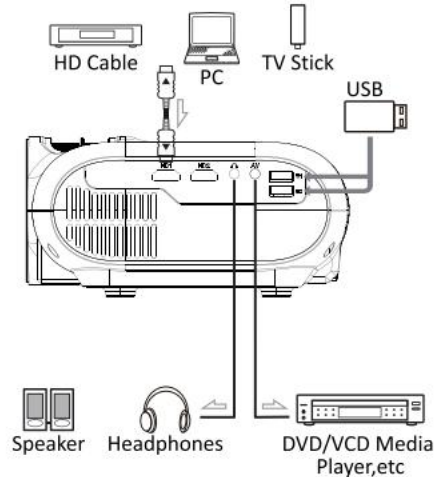

### 7.2 Fire TV Stick Connection

How to connect the Fire TV stick to the projector:

1. Connect the TV stick to power using the USB cable.
2. Plug the TV stick to one of the HD ports on the projector.
3. Select the HD option in the settings on the projector.

The content of the Fire TV stick will be displayed on the projection screen. Use the Fire stick's remote to select and stream your content.



### 7.3 HD mode

**Step 1:** Connect the projector and device with HD cable.

**Step 2:** Press and hold the Source button  of the projector or remote control to enter the input source interface.

**Step 3:** Select HD1 or HD2 that you had connected, press OK to enter, press return key to exit and return to the main interface of the projector.

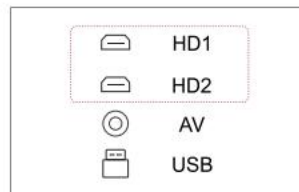

### 7.4 USB mode

**Step 1:** Connect the projector to the USB.

**Step 2:** Press and hold the Source button  of the projector or remote control to enter the input source interface.

**Step 3:** Select USB and press OK to enter the module interface (the same of home page).

**Step 4:** Select the corresponding Movie, Music, Picture and text modules of the file type, and press OK to enter the file interface

**Step 5:** Select the file to be played in the file interface and press OK to select play.

**Step 6:** Press the return key to exit and return to the main interface of the projector.

### 7.5 AV mode

**Step 1:** Connect the projector and the device with the AV cable.

**Step 2:** Press and hold the Source button  of the projector or remote control to enter the input source interface.

**Step 3:** Select AV, press OK to enter, press return key to exit and return to the main interface of the projector.

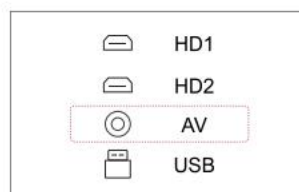

## 8 BT settings

1. Power on and enter the projector's main menu, select BT and click OK button to confirm.

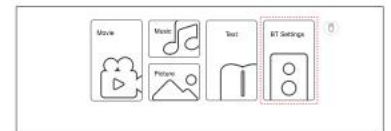

2. Turn on BT and select the BT signal that needs to be connected.

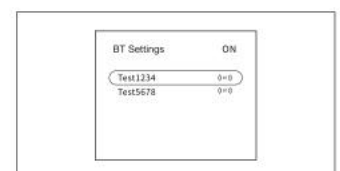

**Enjoy your new projector!**



## ISED WARNINGS

This device contains licence-exempt transmitter(s)/receiver(s) that comply with Innovation, Science and Economic Development Canada's licence-exempt RSS(s). Operation is subject to the following two conditions:

- (1) This device may not cause interference.
- (2) This device must accept any interference, including interference that may cause undesired operation of the device.

L'émetteur/récepteur exempt de licence contenu dans le présent appareil est conforme aux CNR d'Innovation, Sciences et Développement économique Canada applicables aux appareils radio exempts de licence. L'exploitation est autorisée aux deux conditions suivantes :

- (1) L'appareil ne doit pas produire de brouillage;
- (2) L'appareil doit accepter tout brouillage radioélectrique subi, même si le brouillage est susceptible d'en compromettre le fonctionnement.

Le présent appareil est conforme Après examen de ce matériel aux conformité ou aux limites d'intensité de champ RF, les utilisateurs peuvent sur l'exposition aux radiofréquences et compliance d'acquérir les informations correspondantes. La distance minimale du corps à utiliser le dispositif est de 20cm.

## FCC Radiation Exposure Statement:

This equipment complies with FCC radiation exposure limits set forth for an uncontrolled environment. This equipment should be installed and operated with minimum distance 20cm between the radiator&your body.

## WARNING

Changes or modifications not expressly approved by the party responsible for compliance could void the user's authority to operate the equipment.

NOTE: This equipment has been tested and found to comply with the limits for a Class B digital device, pursuant to Part 15 of the FCC Rules. These limits are designed to provide reasonable protection against harmful interference in a residential installation. This equipment generates uses and can radiate radio frequency energy and, if not installed and use in accordance with the instructions, may cause harmful interference to radio communications. However there is no guarantee that interference will not occur in a particular installation. If this equipment does cause harmful interference to radio or television reception, which can be determined by turning the equipment off and on, the user is encouraged to try to correct the interference by one or more of the following measures: Reorient or relocate the receiving antenna. Increase the separation between the equipment and receiver. Connect the equipment into an outlet on a circuit different from that to which the receiver is connected. Consult the dealer or an experienced radio/TV technician for help.

## FCC STATEMENT:

This device complies with Part 15 of the FCC Rules. Operation is subject to the following two conditions:

- (1) This device may not cause harmful interference.
- (2) This device must accept any interference received, including interference that may cause undesired operation.

## Declaration of Conformity

We(Manufacturer is responsible for this declaration)  
Dyanic (Shenzhen) Technology Limited  
(Company name)

20th Floor, Building 4, Tianan Cloud Park, Bantian St., Longgang District, Shenzhen,China  
(Company address)

Declare under our sole responsibility that the product  
Trade name: ULTIMEA  
Equipment: Projector  
Model No.: U0321

To which this declaration relates is in conformity with the essential requirement set out in the Council Directive on the Approximation of the laws of the Member States relating to LVD Directive(2014/53/EU)&Rohs (2011/65/EU) product is responsible to affix CE marking,the following standards were applied:

EN 62368-1:2014+A11:2017  
EN IEC 62311:2020  
ETSI EN 301 489-1 V2.2.3(2019-11)  
ETSI EN 301 489-17 V3.2.4(2020-09)  
EN 55032:2015  
EN 55035:2017  
EN 61000-3-2:2019  
EN 61000-3-3:2013+A1:2019  
ETSI EN 300 328 V2.2.2(2019-7)  
IEC 62321-3-1:2013  
IEC 62321-5:2013  
IEC 62321-4:2013+AMD1:2017  
IEC 62321-6:2015  
IEC 62321-7-2:2017  
IEC 62321-6:2015  
IEC 62321-8:2017

Signature:  Date: 2023.1.6

# ULTIMEA



SHUNSHUN GmbH  
Römeräcker 9 Z2021, 76351 Linkenheim-Hochstetten, Germany



UK Crossborder limited  
7 Bell Yard London WC2A 2JR, UK United Kingdom

Made in China

Manufacturer: Dyanic (Shenzhen) Technology Limited  
Address: 20th Floor, Building 4, Tianan Cloud Park, Bantian St., Longgang District, Shenzhen, China 518000  
FCC ID: 2A900-U0321P  
IC: 29805-U0321P

@Dyanic Inc. All rights reserved, registered in the United States and other countries.  
16192 Coastal Hwy Lewes DE 19958, United States

If we can be of assistance, please do not hesitate to contact us.

+1 888-598-8875 (US)  
Mon-Fri 9am-5pm (PST)  
+49 89-628-25828 (EU)  
Mon-Fri 9am-5pm (CET)

✉ support@ultimea.com

🌐 support.ultimea.com



@ultimea\_official

ULTIMEA

# FULL HD BEAMER BENUTZERHANDBUCH

Apollo P20



Modell-Nr.: U0321

1080P

## WIR SIND BEREIT ZU Helfen



support@ultimea.com

### Bevorzugen Sie Video-Tutorials?

Einrichtungsvideo und  
Benutzerhandbücher auf  
der ULTIMEA-Website.



support.ultimea.com

@Ultimea\_Official

+1 888-598-8875 (US) Mon-Fri 9am-5pm (PST)  
+49 89-628-25828 (EU) Mon-Fri 9am-5pm (CET)

**WICHTIG:** Bevor Sie den Projektor in Betrieb nehmen, lesen Sie bitte diese Einrichtungsanleitung. Für eine ausführlichere Anleitung lesen Sie bitte das Online-Benutzerhandbuch. Ihr Produkt kann sich von den Abbildungen auf diesem Blatt unterscheiden, aber die Anweisungen sind dieselben.

**Hinweis:** Aufgrund der Type-C-Protokolle kann das Android-Telefon/Pad nicht per USB-oder HD-Kabelverbindung abgespielt werden.

### 1 Zubehörliste



Apollo P20

Fernbedienung  
(Batterien nicht  
enthalten)

Kurzanleitung



AV-Kabel



HD-Kabel



Netzkabel

### 2 Produkt

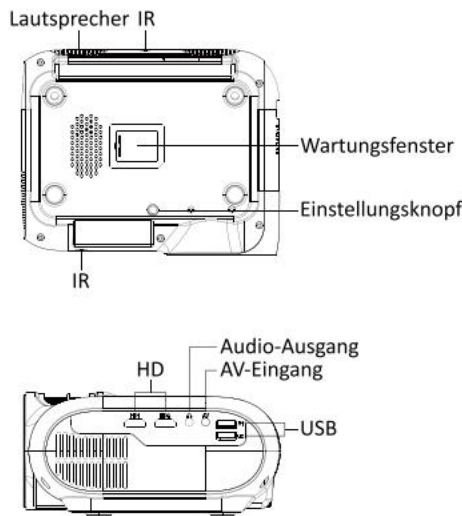
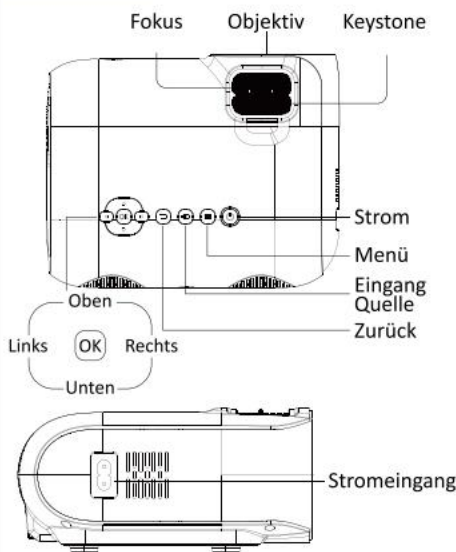

### 3 Fernbedienung

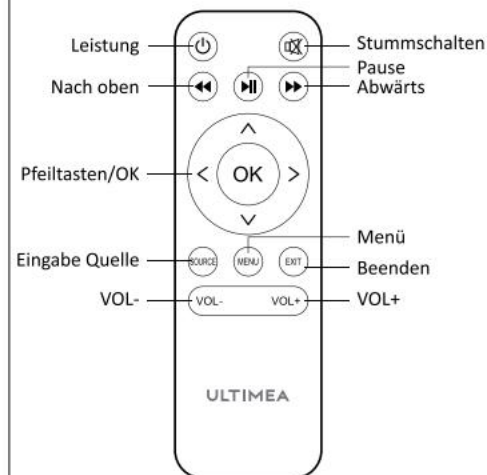

### 4 Schnelles Einrichten

#### 4.1 Einschalten / Ausschalten

Schließen Sie das Netzkabel an, drücken Sie die Einschalttaste auf dem Bedienfeld des Geräts oder auf der Fernbedienung und der Projektor beginnt zu arbeiten.



#### 4.2 Projektor-Installation

Sie können zwischen horizontaler Aufstellung und Aufhängung wählen.

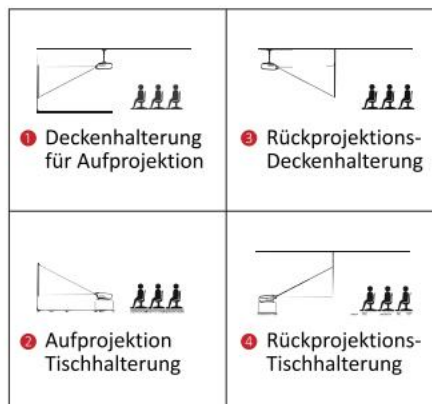
Horizontale  
PlatzierungMontage der  
Aufhängung

Die Projektionsfläche kann von 35" bis 120" bespielt werden. Die empfohlene Projektionsfläche beträgt 40" bis 80". Die Dunkelheit der Umgebung verbessert die Klarheit der projizierten Bilder.

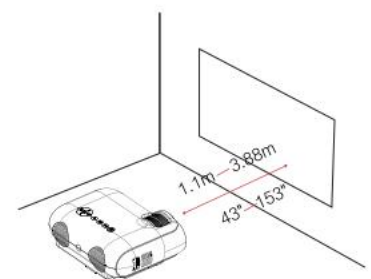

Der Abstand zwischen dem Apollo P20 und der Projektionsfläche muss mindestens 1,1 Meter (35 Zoll) und maximal 3,88 Meter (120 Zoll) betragen.



## 5 Einstellen des Projektorbildes

### 5.1 Bitte stellen Sie den Drehknopf langsam ein, um das Bild scharf zu stellen.

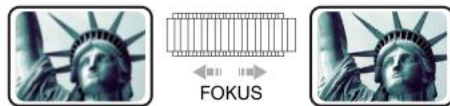

### 5.2 Einstellen des auf die Leinwand projizierten Bildes

Überprüfen Sie die horizontalen und vertikalen Einstellungen des Projektors, bis das Bild auf der Leinwand ausgeglichen ist.

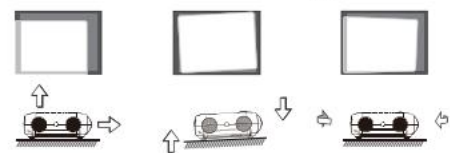

## 6 Trapezkorrektur

1. Stellen Sie die Trapezkorrektur am Projektor ein, um die Form des Bildes anzupassen.



2. Passen Sie die Position des Projektors an. Wenn die linke Seite des Bildes breiter ist, verschieben Sie die linke Seite des Projektors entsprechend dem Bild nach vorne; wenn die rechte Seite des Bildes breiter ist, verschieben Sie die rechte Seite des Projektors entsprechend dem Bild nach vorne.



## 7 Eingangsquelle

### 7.1 Kabelgebundene Verbindung zu Geräten

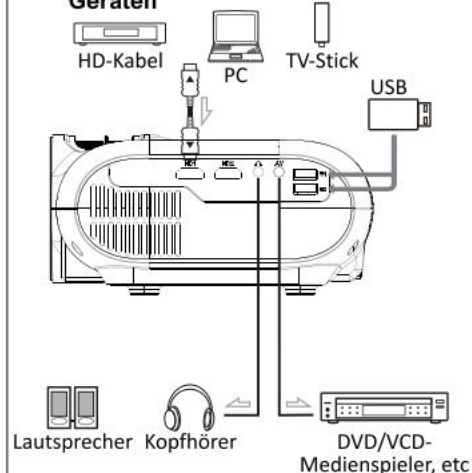

### 7.2 Fire TV Stick Verbindung

So schließen Sie den Fire TV-Stick an den Projektor an:

1. Verbinden Sie den TV-Stick über das USB-Kabel mit dem Stromnetz.
2. Schließen Sie den TV-Stick an einen der HD-Anschlüsse des Projektors an.
3. Wählen Sie die HD-Option in den Einstellungen des Projektors.

Der Inhalt des Fire TV-Sticks wird auf der Projektionsfläche angezeigt. Verwenden Sie die Fernbedienung des Fire Sticks, um Ihre Inhalte auszuwählen und zu streamen.



### 7.3 HD-Modus

**Schritt 1:** Verbinden Sie den Projektor und das Gerät mit einem HD-Kabel.

**Schritt 2:** Halten Sie die Source-Taste  des Projektors oder der Fernbedienung gedrückt, um die Schnittstelle für die Eingangsquelle aufzurufen.

**Schritt 3:** Wählen Sie HD1 oder HD2 aus, die Sie angeschlossen haben, drücken Sie OK zur Bestätigung, drücken Sie die Eingabetaste zum Verlassen und kehren Sie zur Hauptschnittstelle des Projektors zurück.

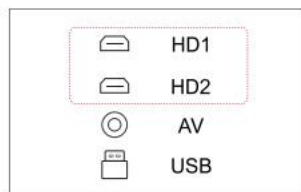

### 7.4 USB-Modus

**Schritt 1:** Schließen Sie den Projektor an den USB-Anschluss an.

**Schritt 2:** Halten Sie die Source-Taste  des Projektors oder der Fernbedienung gedrückt, um die Schnittstelle für die Eingangsquelle aufzurufen.

**Schritt 3:** Wählen Sie USB und drücken Sie OK, um die Modulschnittstelle zu öffnen (dieselbe wie auf der Startseite).

**Schritt 4:** Wählen Sie die entsprechenden Film-, Musik-, Bild- und Textmodule des Dateityps aus und drücken Sie OK, um die Dateischnittstelle zu öffnen.

**Schritt 5:** Wählen Sie die abzuspielende Datei in der Dateischnittstelle und drücken Sie OK, um die Wiedergabe zu starten.

**Schritt 6:** Drücken Sie die Return-Taste, um den Vorgang zu beenden und zur Hauptschnittstelle des Projektors zurückzukehren.

### 7.5 AV-Modus

**Schritt 1:** Verbinden Sie den Projektor und das Gerät mit dem AV-Kabel.

**Schritt 2:** Halten Sie die Source-Taste  des Projektors oder der Fernbedienung gedrückt, um die Eingangsquellen-Schnittstelle aufzurufen.

**Schritt 3:** Wählen Sie AV, drücken Sie OK zum Bestätigen, drücken Sie die Return-Taste zum Verlassen und kehren Sie zur Hauptschnittstelle des Projektors zurück.

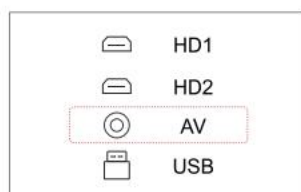

## 8 BT-Einstellungen

1. Schalten Sie den Projektor ein und rufen Sie das Hauptmenü auf, wählen Sie BT und klicken Sie zur Bestätigung auf die OK-Taste.

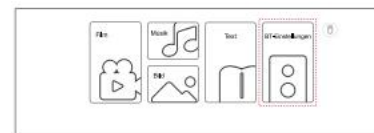

2. Schalten Sie BT ein und wählen Sie das BT-Signal, das angeschlossen werden soll.

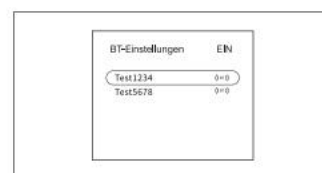

**Viel Spaß mit Ihrem neuen Projektor!**

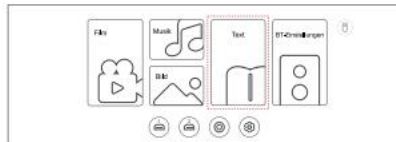
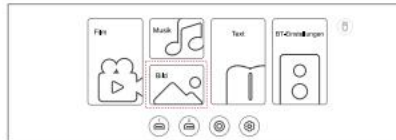
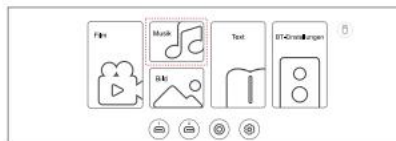
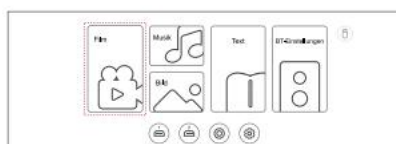

# ULTIMEA MANUAL DE USUARIO DEL PROYECTOR FULL HD

Apollo P20



1080P

Modèle n° : U0321

## NOUS SOMMES DISPOSÉS À VOUS AIDER



support@ultimea.com

### Vous préféreriez un tutoriel vidéo?

Vidéo de conseil d'installation  
et manuels d'utilisation sur le  
site web ULTIMEA.



support.ultimea.com



@Ultimea\_Official

+1 888-598-8875 (US) Mon-Fri 9am-5pm (PST)  
+49 89-628-25828 (EU) Mon-Fri 9am-5pm (CET)

**IMPORTANT:** Avant toute utilisation du projecteur, veuillez lire ce guide d'installation. Pour de plus amples informations, veuillez consulter le manuel d'utilisation en ligne. Votre produit pourrait être différent des figures de cette feuille, mais les instructions sont les mêmes.

**Remarque:** Du fait des protocoles Type-C, les appareils androïdes ne peuvent pas être raccordés par câble USB ou HD.

## 1 Liste des accessoires



Apollo P20



Télécommande  
(Piles non incluses)



Guide  
d'utilisation  
rapide



Câble AV



Câble HD



Câble  
d'alimentation

## 2 Produit

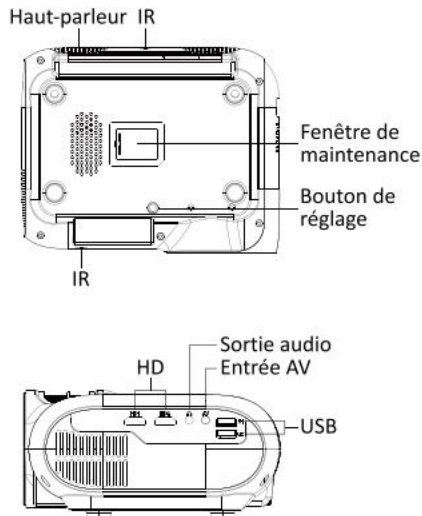
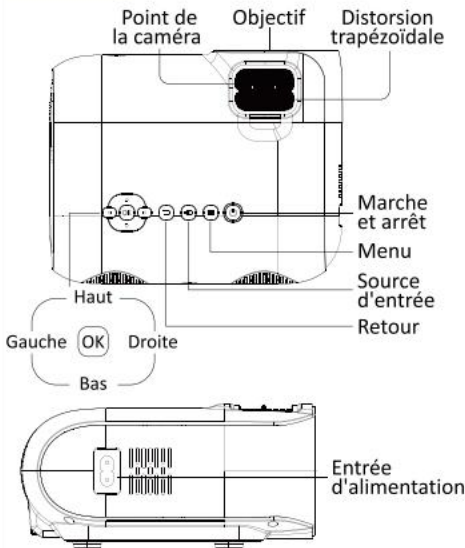

## 3 Télécommandes

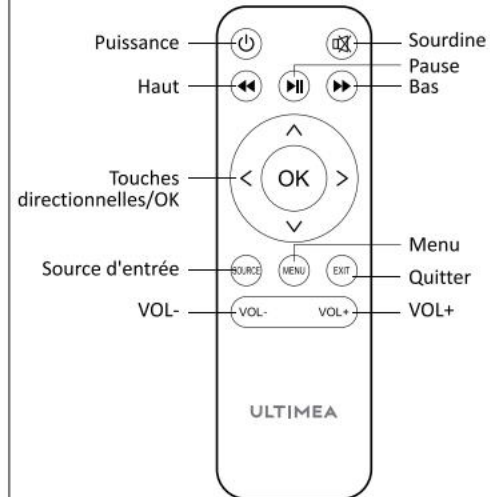

## 4 Configuration rapide

### 4.1 Marche / Arrêt

Branchez le câble d'alimentation secteur, cliquez sur le bouton d'alimentation sur le panneau de commande de la machine ou sur la télécommande et le projecteur commencera à fonctionner.



### 4.2 Installation du projecteur

Vous pouvez opter pour un positionnement horizontal ou une installation sur support.

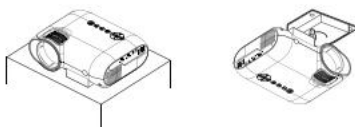

Installation horizontale Fixation sur support

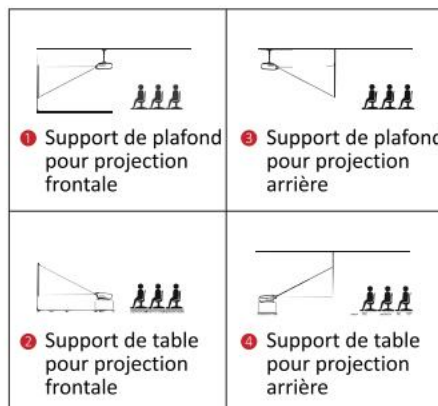

L'écran de projection peut être joué de 35" à 120". L'écran de projection recommandé est 40" à 80". L'obscurité ambiante améliore la clarté des images projetées.

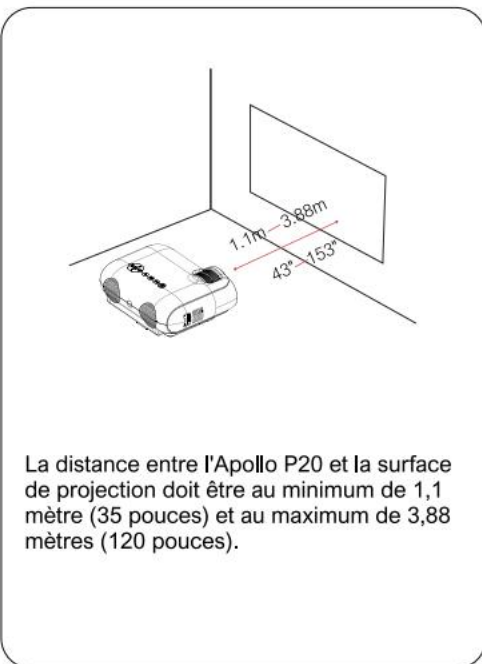

La distance entre l'Apollo P20 et la surface de projection doit être au minimum de 1,1 mètre (35 pouces) et au maximum de 3,88 mètres (120 pouces).



## 5 Réglage de l'image du projecteur

### 5.1 Veuillez régler lentement la molette pour faire la mise au point sur la photo.



### 5.2 Régler l'image projetée sur l'écran

Vérifiez les réglages horizontaux et verticaux de l'écran.

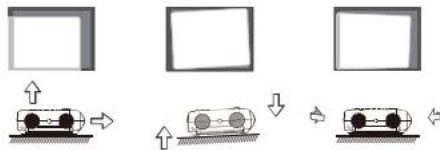

## 6 Correction de la distorsion trapézoïdale

1. Réglez la distorsion trapézoïdale du projecteur pour ajuster la forme des images.



2. Réglez le positionnement du projecteur. Lorsque le côté gauche de l'image est plus large, déplacez le côté gauche du projecteur correspondant à l'image vers l'avant; lorsque le côté droit de l'image est plus large, déplacez le côté droit du projecteur correspondant à l'image vers l'avant.



## 7 Source d'entrée

### 7.1 Connexion filaire aux appareil

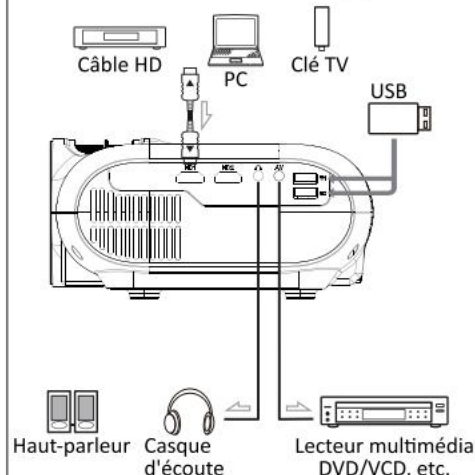

### 7.2 Connexion du Fire TV Stick

Comment connecter le Fire TV stick au projecteur ?

1. Branchez la clé TV sur le secteur à l'aide du câble USB.
2. Branchez la clé sur le port HD du projecteur.
3. Choisissez l'option HD dans les paramètres du projecteur.

Le contenu du Fire TV stick s'affiche sur l'écran de projection. Utilisez la télécommande du Fire TV stick pour sélectionner et diffuser votre contenu.



### 7.3 Modo HD

**Étape 1:** Connectez le projecteur et l'appareil avec un câble HD.

**Étape 2:** Appuyez et maintenez le bouton  Source du projecteur ou de la télécommande pour entrer dans l'interface de la source d'entrée.

**Étape 3:** Choisissez HD, appuyez sur OK pour entrer, appuyez sur la touche retour pour quitter et revenir à l'interface principale du projecteur.

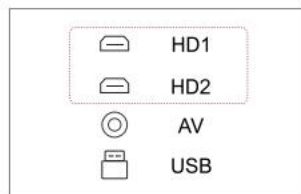

### 7.4 Modo USB

**Étape 1:** Connectez le projecteur à la prise USB.

**Étape 2:** Appuyez et maintenez le bouton  Source du projecteur ou de la télécommande pour entrer dans l'interface de la source d'entrée.

**Étape 3:** Sélectionnez USB et appuyez sur OK pour accéder à l'interface du module.

**Étape 4:** Sélectionnez le film correspondant, Les modules Musique, et Image du type de fichier, et appuyez sur OK pour entrer dans l'interface de fichier.

**Étape 5:** Sélectionnez le fichier à lire dans l'interface de fichier et appuyez sur OK pour sélectionner la lecture.

**Étape 6:** Appuyez sur la touche retour pour quitter et revenir à l'interface principale du projecteur.

### 7.5 Modo AV

**Étape 1:** Connectez le projecteur et l'appareil avec le câble AV.

**Étape 2:** Maintenez enfoncée la touche  Source du projecteur ou de la télécommande pour accéder à l'interface de la source d'entrée.

**Étape 3:** Sélectionnez AV, appuyez sur OK pour valider, appuyez sur la touche retour pour quitter et revenir à l'interface principale du projecteur.

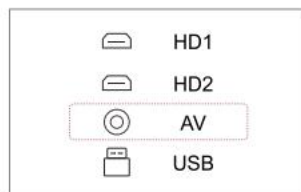

## 8 Réglages BT

1. Allumez et entrez dans le menu principal du projecteur, sélectionnez BT et cliquez sur le bouton OK pour confirmer.

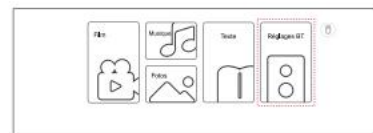

2. Activez BT et sélectionnez le signal BT qui doit être connecté.

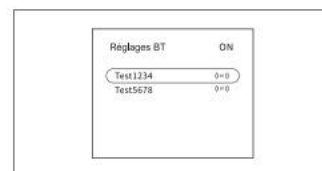

**Profitez bien de votre nouveau projecteur!**

# ULTIMEA MANUALE D'USO DEL PROIETTORE FULL HD

**Apollo P20**



Modelo No.: U0321

**1080P**

## ESTAMOS LISTOS PARA AYUDAR



support@ultimea.com

### ¿Prefiere un video tutorial?

Video orientativo de instalación y manuales de usuario en el sitio web de ULTIMEA.



support.ultimea.com

@Ultimea\_Official

+1 888-598-8875 (US) Mon-Fri 9am-5pm (PST)  
+49 89-628-25828 (EU) Mon-Fri 9am-5pm (CET)

**IMPORTANTE:** Antes de utilizar el proyector, lea esta guía de instalación. Para obtener instrucciones más detalladas, consulte el Manual del usuario en línea. Su producto puede diferir de las ilustraciones de esta hoja, pero las instrucciones son las mismas.

**Nota:** Debido a los protocolos Tipo-C, el dispositivo android no se puede reproducir mediante conexión USB o cable HD.

### 1 Lista de Accesorios



Apollo P20



Control remoto (Baterías no incluidas)



Guía Rápida



Cable AV



Cable HD



Cable de Alimentación

### 2 Producto

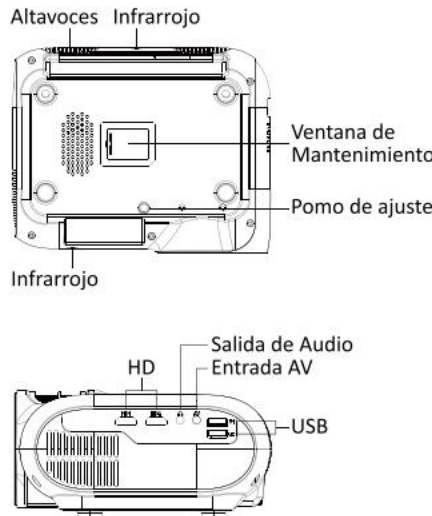
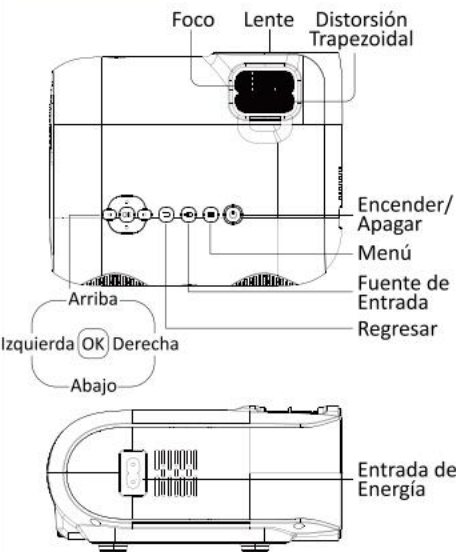

### 3 Control Remoto

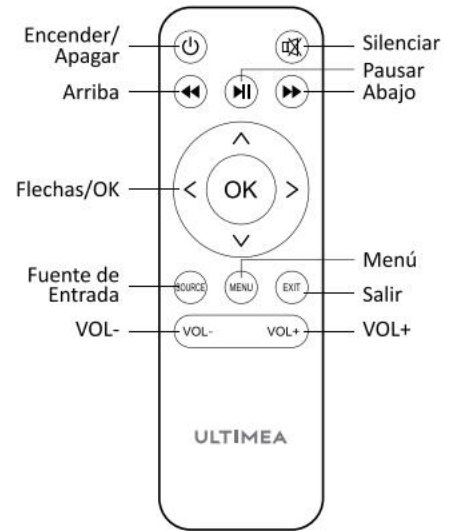

### 4 Inicio Rápido

#### 4.1 Encender / Apagar

Enchufe el cable de alimentación, pulse el botón de encendido en el panel de control de la máquina o en el mando a distancia y el proyector empezará a funcionar.



#### 4.2 Instalación del proyector

Puede elegir la colocación horizontal o la instalación colgante.

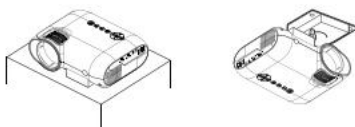

Colocación horizontal Colocación colgante

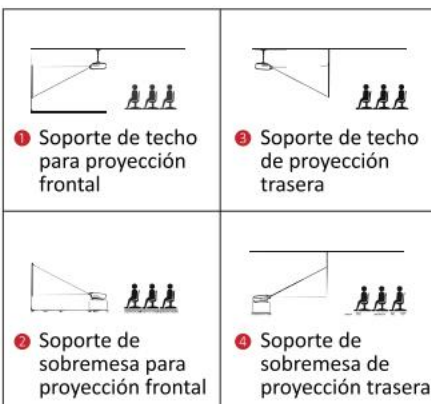

La proyección de la pantalla puede reproducirse en un ángulo de 32° a 120°. El ángulo de proyección recomendado es de 40° a 80°. La oscuridad ambiental mejorará la claridad de las imágenes proyectadas.

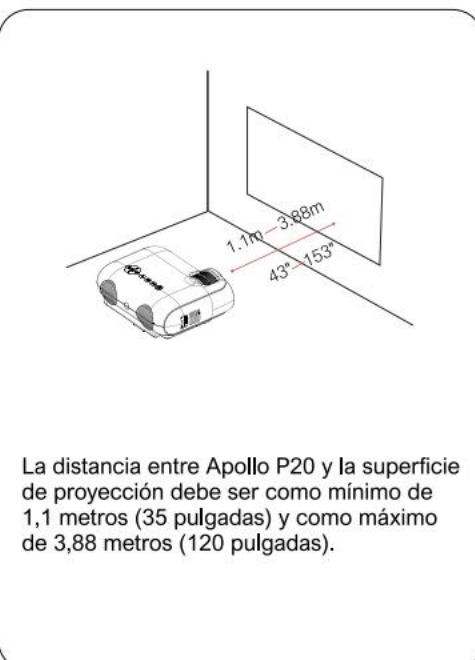

La distancia entre Apollo P20 y la superficie de proyección debe ser como mínimo de 1,1 metros (35 pulgadas) y como máximo de 3,88 metros (120 pulgadas).



## 5 Ajustando la imagen del proyector

### 5.1 Ajuste el dial lentamente para enfocar la imagen

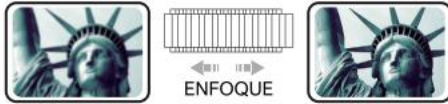

### 5.2 Ajuste la imagen proyectada en la pantalla

Compruebe los ajustes horizontales y verticales del proyector hasta que la imagen en la pantalla esté equilibrada.

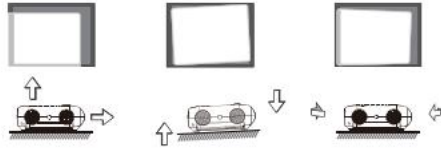

## 6 Corrección de distorsión trapezoidal

1. Ajuste la distorsión trapezoidal en el proyector para ajustar la forma de las imágenes.



2. Ajuste la colocación del proyector. Cuando el lado izquierdo de la imagen sea más ancho, mueva el lado izquierdo del proyector correspondiente a la imagen hacia delante; cuando el lado derecho de la imagen sea más ancho, mueva el lado derecho del proyector correspondiente a la imagen hacia delante.



## 7 Fuente de Entrada

### 7.1 Conexión por cable a los dispositivos

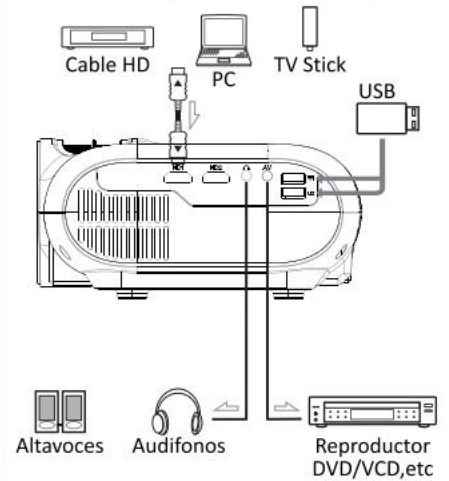

### 7.2 Conexión Fire TV Stick

Cómo conectar el Fire TV stick al proyector:

1. Conecta el lápiz de TV a la corriente mediante el cable USB.
2. Conecta el stick al puerto HD del proyector.
3. Selecciona la opción HD en los ajustes del proyector.

El contenido del Fire TV stick se mostrará en la pantalla de proyección. Utiliza el mando a distancia del Fire stick para seleccionar y transmitir el contenido.



### 7.3 Modo HD

**Paso 1:** Conecta el proyector y el dispositivo con un cable HD.

**Paso 2:** Mantenga pulsado el botón  Fuente del proyector o del mando a distancia para acceder a la interfaz de la fuente de entrada.

**Paso 3:** Seleccione HD, pulse OK para entrar, pulse la tecla retroceder para salir y volver a la interfaz principal del proyector.

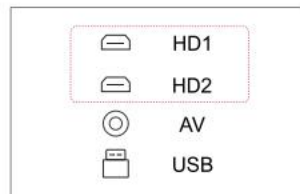

### 7.4 Modo USB

**Paso 1:** Conecta el proyector al USB.

**Paso 2:** Mantenga pulsado el botón  Fuente del proyector o del mando a distancia para acceder a la interfaz de la fuente de entrada.

**Paso 3:** Seleccione USB y pulse OK para entrar en la interfaz del módulo.

**Paso 4:** Seleccione los módulos correspondientes de Película, Música e Imagen del tipo de archivo y pulsa OK para entrar en la interfaz del archivo.

**Paso 5:** Seleccione el archivo a reproducir en la interfaz de archivos y pulsa OK para seleccionar la reproducción.

**Paso 6:** Pulse la tecla de retorno para salir y volver a la interfaz principal del proyector.

### 7.5 Modo AV

**Paso 1:** Conecte el proyector y el dispositivo con el cable AV.

**Paso 2:** Mantenga pulsado el botón  Fuente del proyector o del control remoto para acceder a la interfaz de la fuente de entrada.

**Paso 3:** Seleccione AV, pulse OK para entrar, pulse la tecla retroceder para salir y volver a la interfaz principal del proyector.

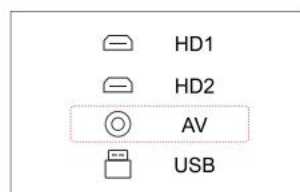

## 8 Opciones BT

1. Encienda el proyector y acceda al menú principal, seleccione BlueTooth y haga clic en el botón OK para confirmar.

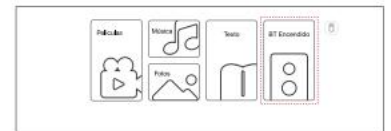

2. Encienda BT y seleccione la señal BT que desea conectar.

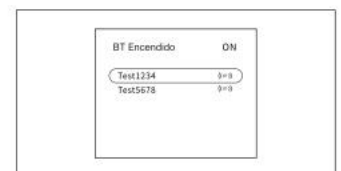

¡Disfrute de su nuevo proyector!

# ULTIMEA MANUEL D'UTILISATION DU PROJECTEUR FULL HD

**Apollo P20**



Modellon.: U0321

**1080P**

## SIAMO PRONTI AD AIUTARE



support@ultimea.com

### Preferite un video tutorial?

Video guida all'installazione  
e manuali d'uso sul sito  
web di ULTIMEA.



support.ultimea.com

@Ultimea\_Official +1 888-598-8875 (US) Mon-Fri 9am-5pm (PST)  
+49 89-628-25828 (EU) Mon-Fri 9am-5pm (CET)

**IMPORTANTE:** Prima di utilizzare il proiettore, leggere la presente guida all'installazione; per istruzioni più dettagliate, consultare il Manuale d'uso online. Il vostro prodotto potrebbe differire dalle illustrazioni di questo foglio, ma le istruzioni sono le stesse.

**Nota:** a causa dei protocolli Type-C, il telefono/pad Android non può essere riprodotto tramite connessione USB o cavo HD.

## 1 Elenco degli accessori



Apollo P20



Telecomando  
(batterie non  
include)



Guida rapida



Cavo AV



Cavo HD



Cavo di  
alimentazione

## 2 Prodotto

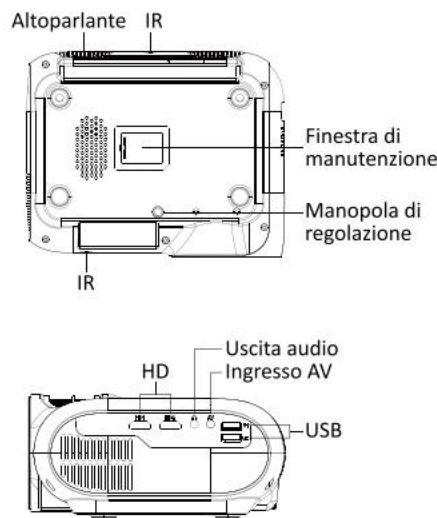
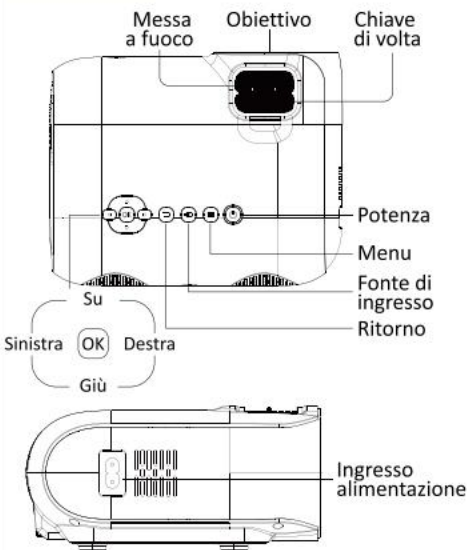

## 3 Telecomando

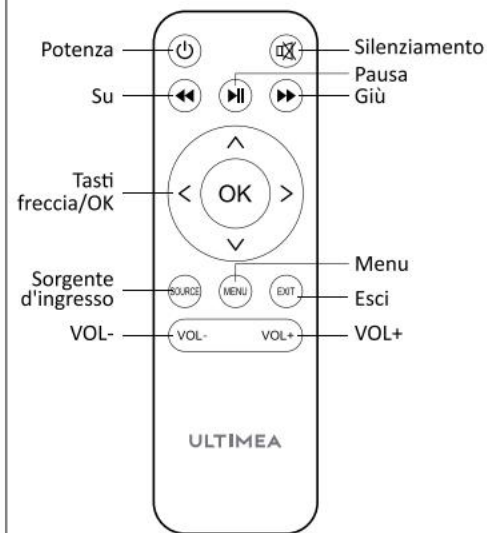

## 4 Impostazione rapida

### 4.1 Accensione / Spegnimento

Collegare il cavo di alimentazione CA, fare clic sul pulsante di accensione sul pannello operativo della macchina o sul telecomando e il proiettore inizierà a funzionare.



### 4.2 Installazione del proiettore

È possibile scegliere la collocazione orizzontale o l'installazione con gancio.



Posizionamento  
orizzontale



Installazione  
della gruocia

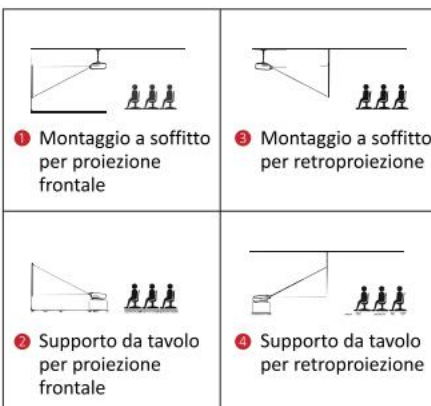

Lo schermo di proiezione può essere riprodotto da 35" a 120". Lo schermo di proiezione consigliato va da 40" a 80". L'oscurità ambientale migliorerà la nitidezza delle immagini proiettate.

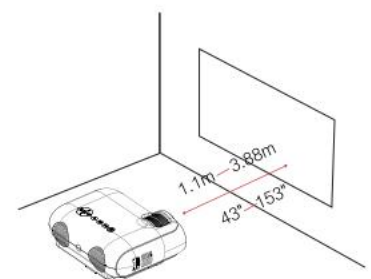

La distanza tra Apollo P20 e la superficie di proiezione deve essere compresa tra un minimo di 1,1 metri (35 pollici) e un massimo di 3,88 metri (120 pollici).



## 5 Regolazione dell'immagine del proiettore

### 5.1 Regolare lentamente il selettore per mettere a fuoco l'immagine

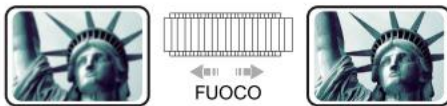

### 5.2 Regolazione dell'immagine proiettata sullo schermo

Controllare le impostazioni orizzontali e verticali del proiettore finché l'immagine sullo schermo non è bilanciata.

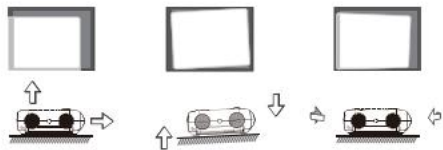

### 7.2 Connessione della Fire TV Stick

Come collegare il Fire TV Stick al proiettore:

1. Collegare la TV stick all'alimentazione tramite il cavo USB.
2. Collegare la TV stick a una delle porte HD del proiettore.
3. Selezionare l'opzione HD nelle impostazioni del proiettore.

Il contenuto del Fire TV stick verrà visualizzato sullo schermo di proiezione. Utilizzare il telecomando del Fire stick per selezionare e trasmettere i contenuti.



## 6 Correzione trapezoidale

1. Regolare la distorsione trapezoidale sul proiettore per regolare la forma delle immagini.



2. Regolare il posizionamento del proiettore. Quando il lato sinistro dell'immagine è più ampio, spostare in avanti il lato sinistro del proiettore corrispondente all'immagine; quando il lato destro dell'immagine è più ampio, spostare in avanti il lato destro del proiettore corrispondente all'immagine.



## 7 Sorgente d'ingresso

### 7.1 Collegamento via cavo ai dispositivi

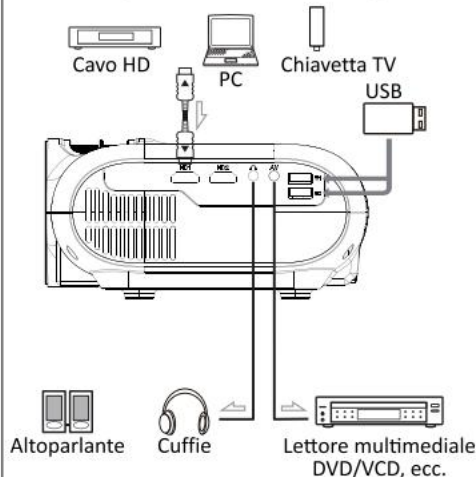

## 8 Impostazioni BT

### 7.5 Modo AV

**Passo 1:** Connect the projector and the device with the AV cable.

**Passo 2:** Tenere premuto il tasto Sorgente del proiettore o del telecomando per accedere all'interfaccia della sorgente di ingresso.

**Passo 3:** Selezionare AV, premere OK per accedere, premere il tasto di ritorno per uscire e tornare all'interfaccia principale del proiettore.

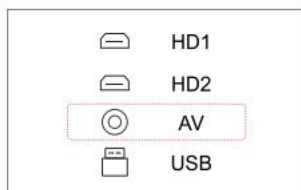

### 7.4 Modo USB

**Passo 1:** Collegare il proiettore alla porta USB.

**Passo 2:** Tenere premuto il tasto Sorgente del proiettore o del telecomando per accedere all'interfaccia della sorgente di ingresso.

**Passo 3:** selezionare USB e premere OK per accedere all'interfaccia del modulo (la stessa della pagina iniziale).

**Passo 4:** Selezionare i moduli Film, Musica, Immagine e Testo corrispondenti al tipo di file e premere OK per accedere all'interfaccia dei file.

**Passo 5:** Selezionare il file da riprodurre nell'interfaccia dei file e premere OK per selezionare la riproduzione.

**Passo 6:** Press the return key to exit and return to the main interface of the projector.

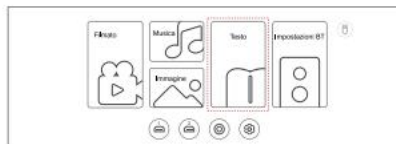
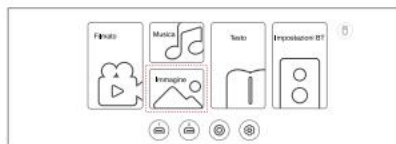
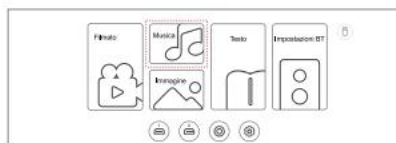
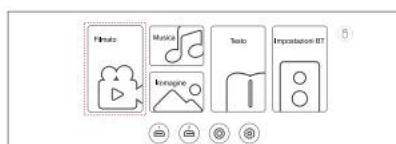

### 7.1 Collegamento via cavo ai dispositivi

1. Accendere il proiettore e accedere al menu principale, selezionare BT e fare clic sul pulsante OK per confermare.

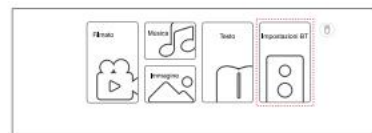

2. Accendere BT e selezionare il segnale BT da collegare.



**Godetevi il vostro nuovo proiettore!**