

A030.046.00  
A030.047.00  
A030.048.00

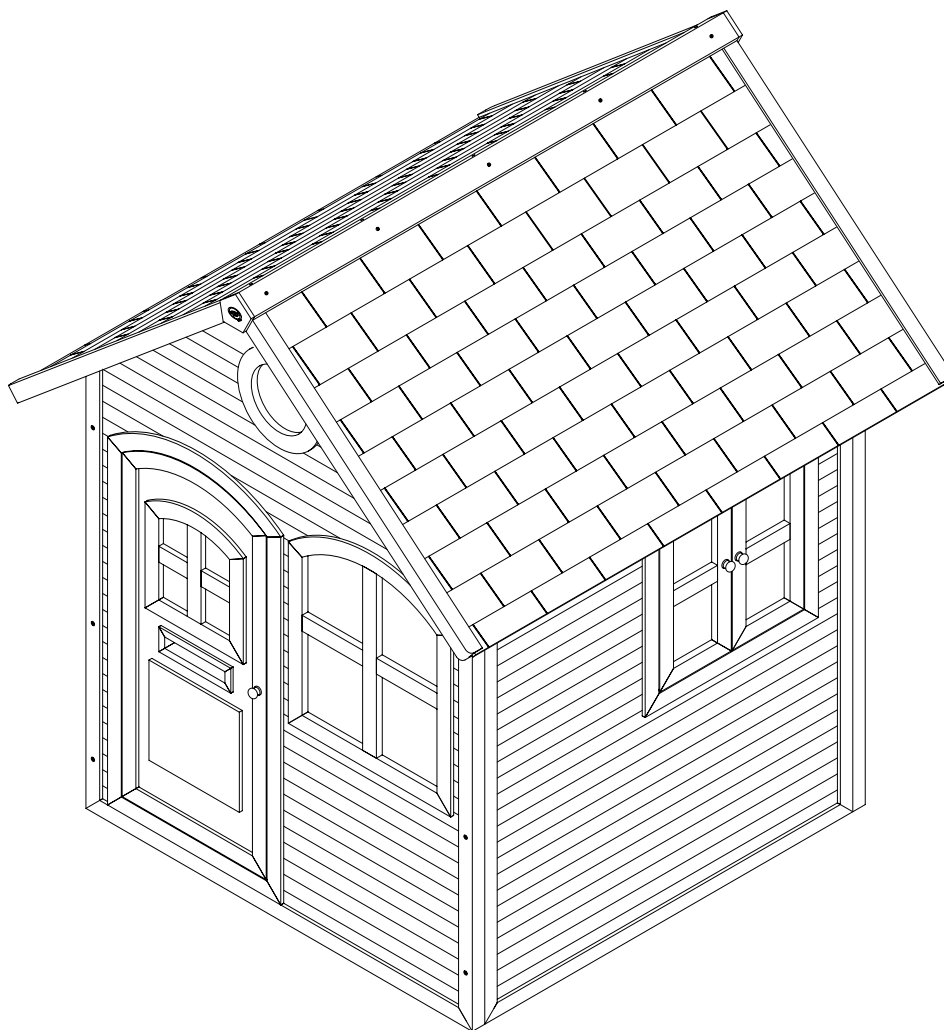

A030.046.00

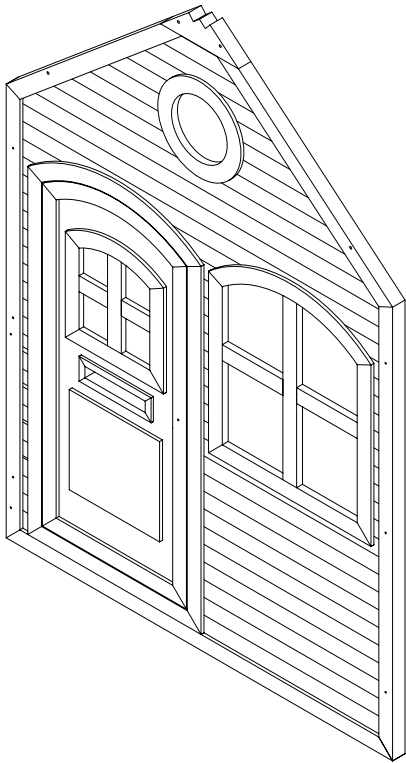

6

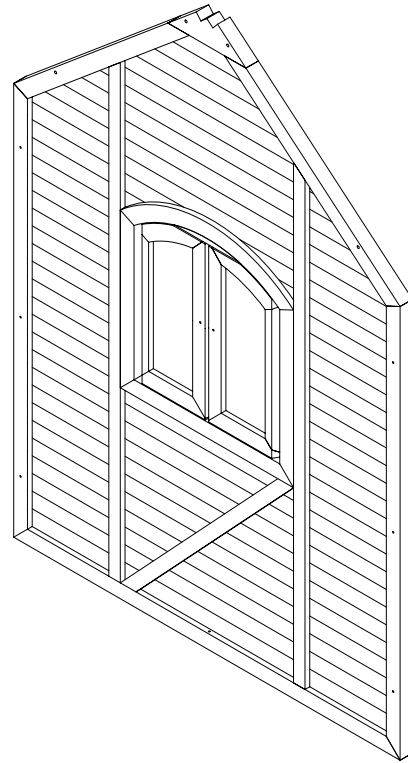

8



9

14x

t1

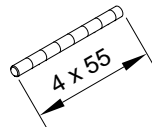

7x

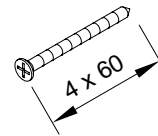

16x

s2

A030.047.00

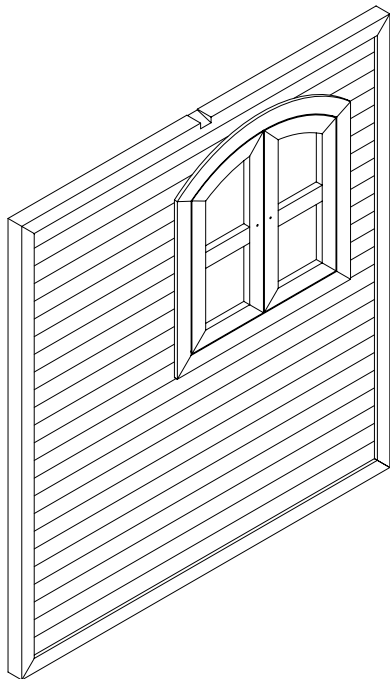

7

2x



A030.048.00

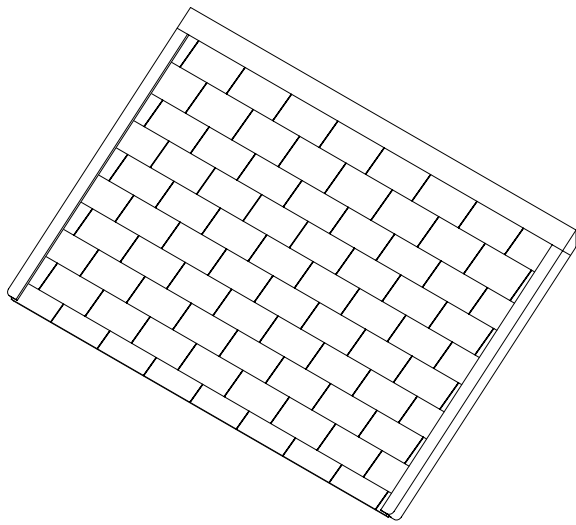

5

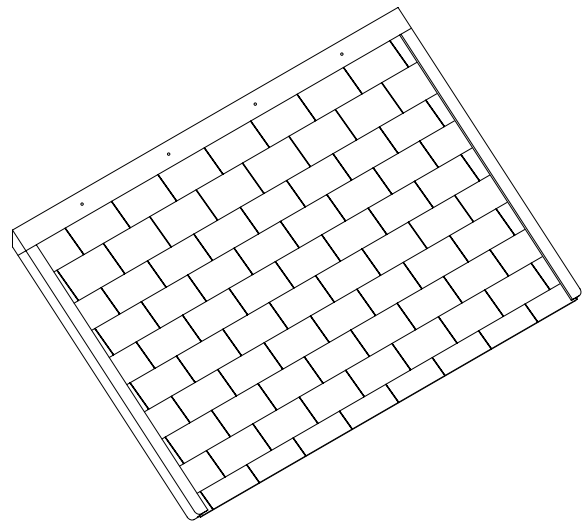

6

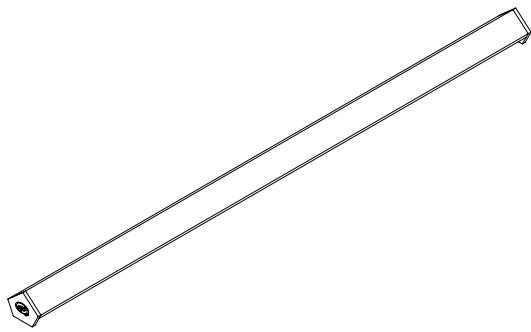

7

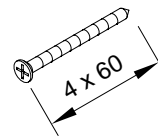

s2

8x

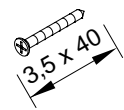

s3

14x



# Julia

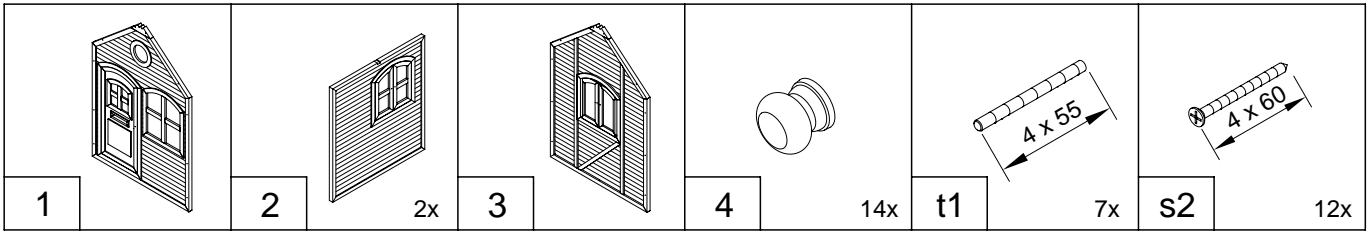

A030.046.00 + A030.047.00

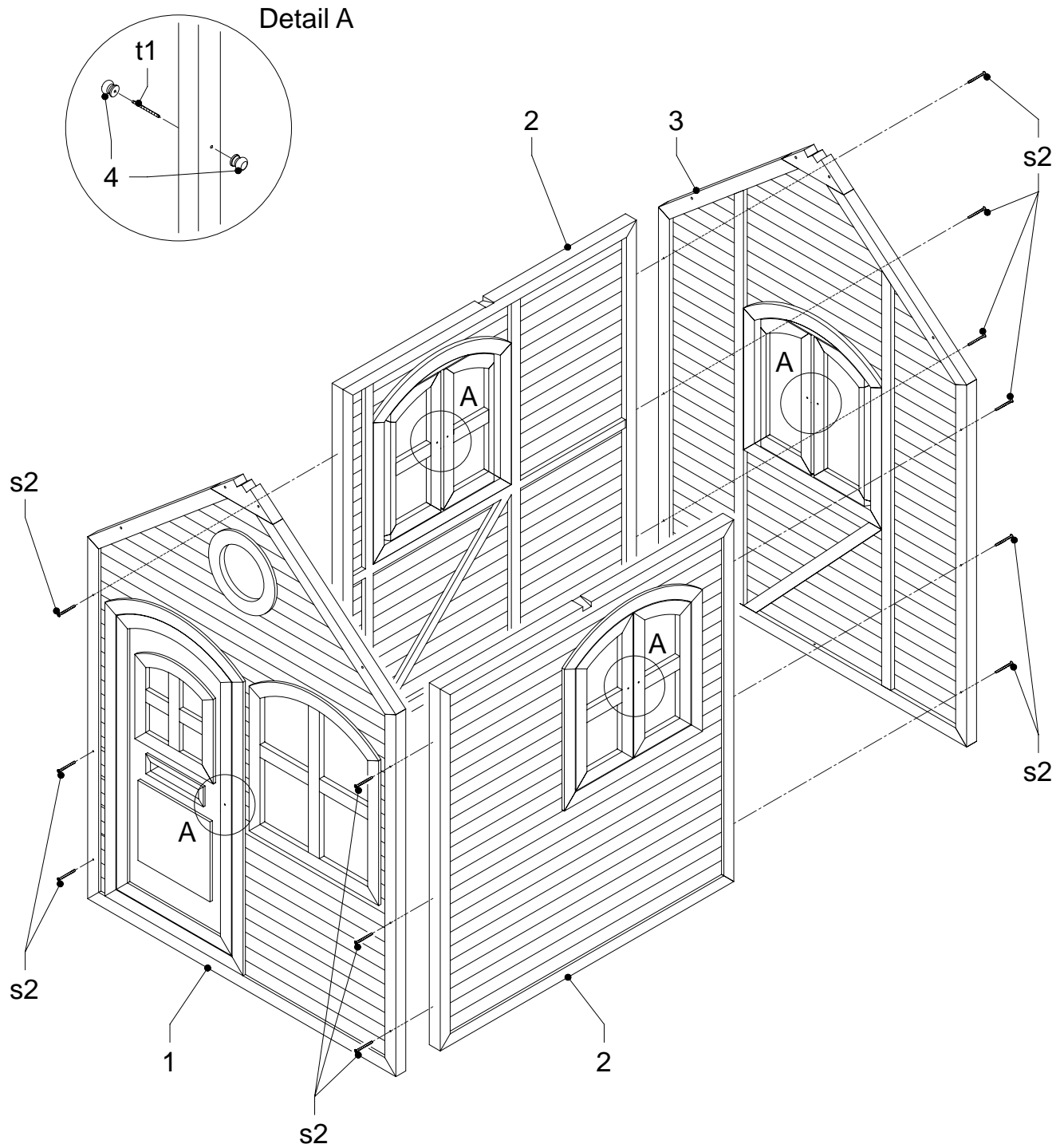



# Julia

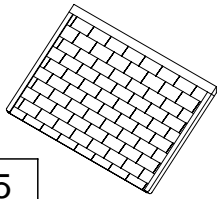

5

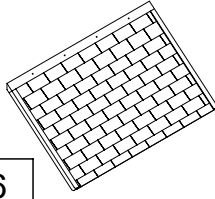

6

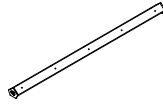

7

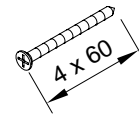

s2

8x

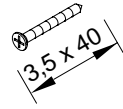

s3

14x

A030.048.00

