

User Manual

Wooden Potting Bench 6059-0458

Note

- Please read this user manual carefully.
- Please keep this manual for future reference.
- Package quantity: 1

Pfillo GmbH

Adresse: Kreuzweg 60, 47809 Krefeld, Germany

E-Mail: pfillo.de@gmail.com

Webseite: www.mcombo.de

I . Catalog

I . Catalog	1
II . PRODUCT PRECAUTIONS	1
III . DISCLAIMER	1
IV . INSTALLATION PREPARATION	2
V . ACCESSORIES LIST	2
VI . INSTALLATION INSTRUCTION	4
VII . WARRANTY	7
VIII . RETURN/REPLACEMENT POLICY	7
IX . CARE AND MAINTENANCE	8
X . MCOMBO CUSTOMER CENTER	8

II. PRODUCT PRECAUTIONS



Read and follow the information in the user's manual.



Please keep kids away from small components to ensure safety.



Recommend to cover the item in extreme weather.



Recommend to cover the item in extreme weather.



The item is polished, can be DIY for freely.



To prolong the service life, recommend to oil.



Please handle wood and other accessories properly.

III.DISCLAIMER



We ask that you read this manual completely before assembling and operating your new item. We are not and cannot be held responsible for any damage or injury incurred due to improper or unsafe use of the item. We specifically disclaim responsibility for any bodily injury or property damage that may occur during any use that does not comply with applicable federal, state, or local laws or ordinances. Please keep this manual for future reference.



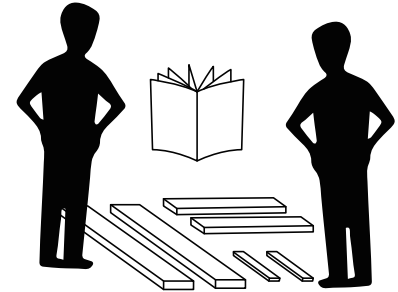

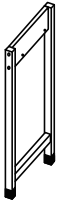
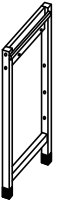

IV. INSTALLATION PREPARATION

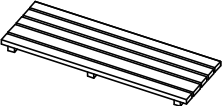
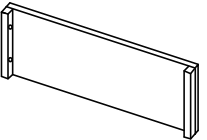
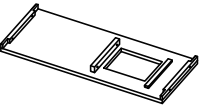
1. Please prepare a carpet or mat to protect your floor. You need to spread out all the accessories.
2. Please prepare a pair of gloves to avoid being scratched by sharp wooden sawdust that may occur during installation.
3. Please open all the boxes to check that the accessories are complete and in good condition (The accessories list in page 3).
4. The box contains some **small components**, please place them properly before installation to keep them **away from kids** and ensure safety.
5. If you need to use power tools to install this product, please **set the speed to low speed in advance**. Due to the characteristics of wood products, the use of high speed during installation is probably to damage the wood.
6. When installing, please align all the holes and **do not tighten all the screws first**, otherwise it may make the installation difficult.

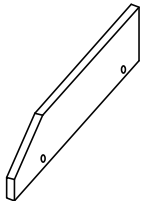
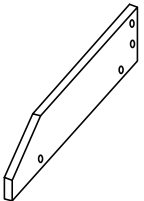
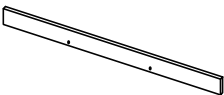
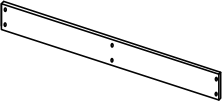
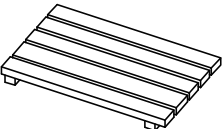
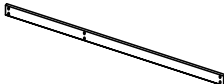
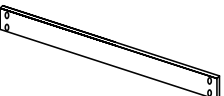

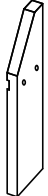
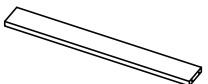
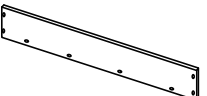
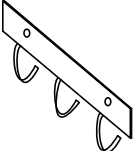
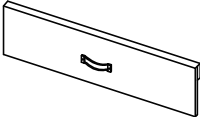
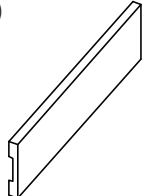
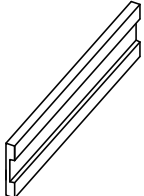
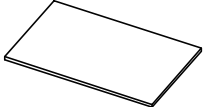
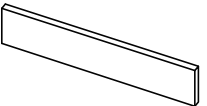
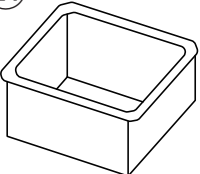
V. Accessories List

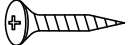
 <p>1 PC</p>	 <p>1 PC</p>	 <p>1 PC</p>	 <p>1 PC</p>	 <p>1 PCS</p>	 <p>1 PC</p>
--	--	--	--	--	---

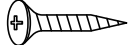
<p>⑦</p>  <p>1 PC</p>	<p>⑧</p>  <p>1 PC</p>	<p>⑨</p>  <p>1 PC</p>	<p>⑩</p>  <p>1 PC</p>	<p>⑪</p>  <p>1 PC</p>	<p>⑫</p>  <p>1 PC</p>
<p>⑬</p>  <p>1 PC</p>	<p>⑭</p>  <p>1 PC</p>	<p>⑮</p>  <p>1 PC</p>	<p>⑯</p>  <p>1 PC</p>	<p>⑰</p>  <p>1 PC</p>	<p>⑱</p>  <p>1 PC</p>
<p>⑲</p>  <p>1 PC</p>	<p>⑳</p>  <p>1 PC</p>	<p>㉑</p>  <p>1 PC</p>	<p>㉒</p>  <p>1 PC</p>	<p>㉓</p>  <p>1 PC</p>	<p>㉔</p>  <p>1 PC</p>
<p>Ⓐ</p>  <p>8 x, 6 x 50 mm</p>	<p>Ⓑ</p>  <p>4 x, 6 x 70 mm</p>	<p>Ⓒ</p>  <p>20 x, 4.2 x 30 mm</p>	<p>Ⓓ</p>  <p>12 x, 3.5 x 40 mm</p>	<p>Ⓔ</p>  <p>4 x, 3.5 x 25 mm</p>	<p>Ⓕ</p>  <p>14 x, 3.5 x 30 mm</p>

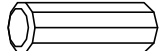
<p>G</p>  <p>2 x, 4 x 12 mm</p>	<p>H</p>  <p>4 x</p>				
---	--	--	--	--	--



Kindly Notes:

1. Please open all boxes to check the quantity and condition of accessories.
2. When installing, please align all the holes and do not tighten all the screws first.

Q: Is there any broken or missing part?

A: If yes, please feel free to contact us, we will do our best to assist you to solve the problem as soon as possible.

VI . INSTALLATION STEPS

Q: How to solve the hole misalignment?

A: Please do not tighten all the screws until aligning all the holes.

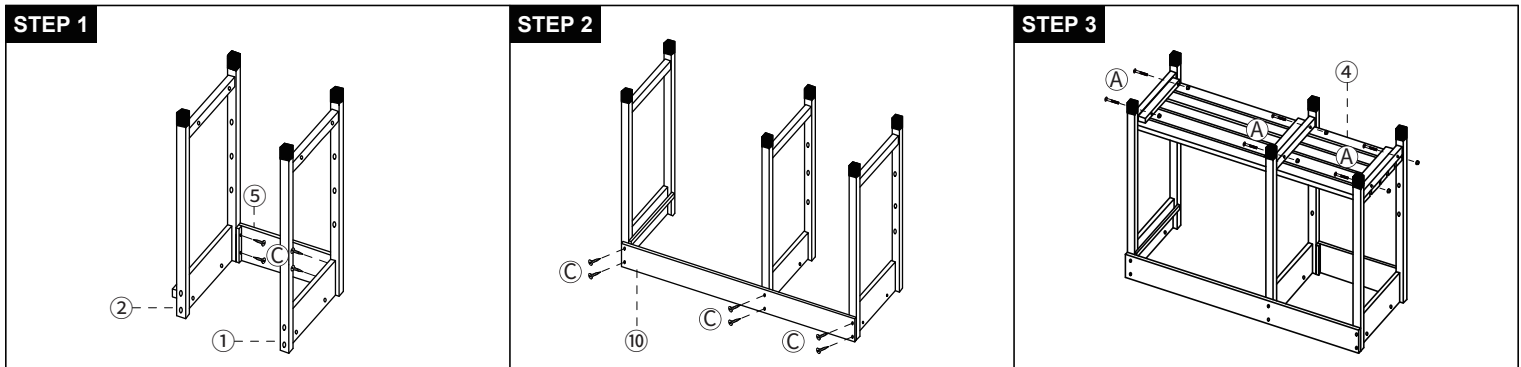

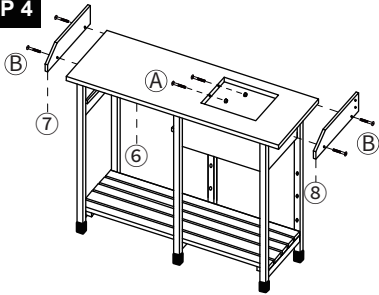
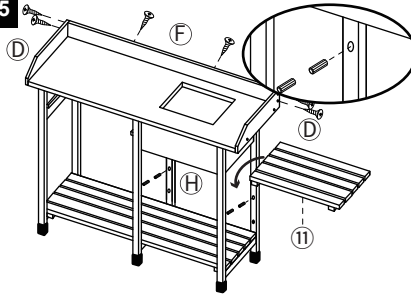
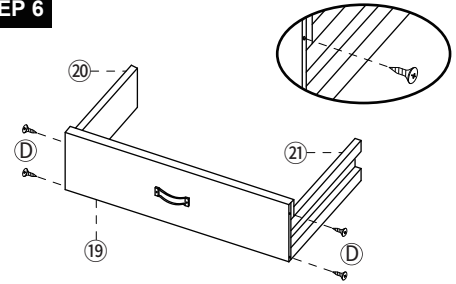
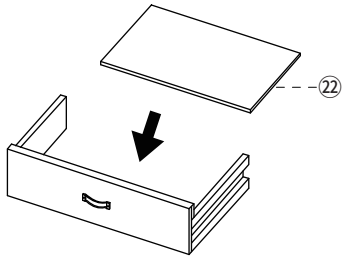
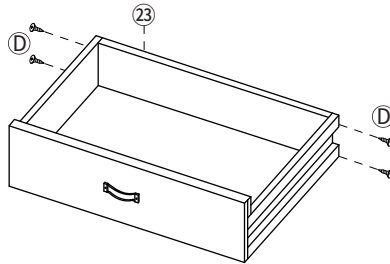
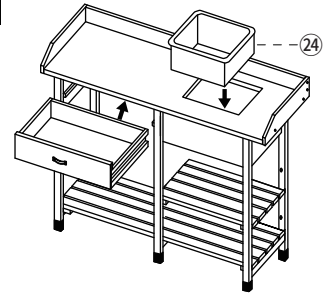
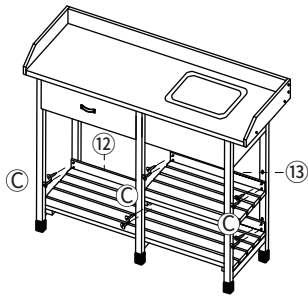
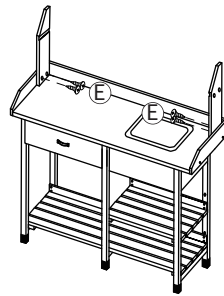
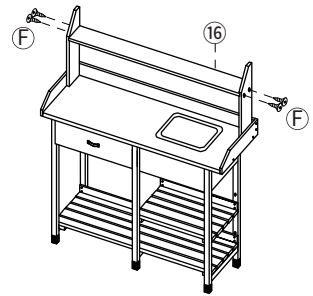
STEP 4**STEP 5****STEP 6****STEP 7****STEP 8****STEP 9****STEP 10****STEP 11****STEP 12**

STEP 13

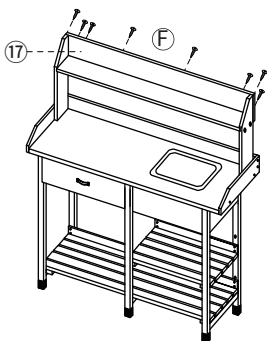

STEP 14

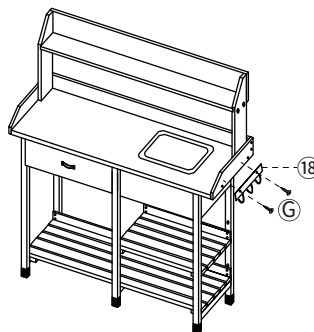

STEP 15

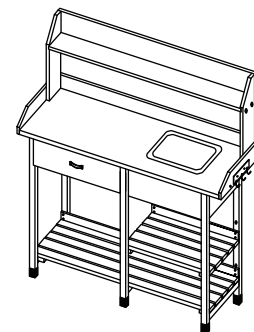

Finish

VII . Warranty Detail Explanation

- Mcombo will replace the defective parts or send a replacement item provided that the warranty parts have not been subjected to misuse abuse or improper service by the consumer, for example, damaged part arising in consequence of negligence or improper operation.

- **Exclusions also include components with damage caused by:**

Contamination

Abuse, misuse, accident or negligence

Commercial use, or use other than normal

Improper operation maintenance, or storage

VIII . RETURN/REPLACEMENT POLICY

MCOMBO all items come with a 30-day return/replace policy during this time we will cover the shipping cost of return and replacement for a defective and damaged item, through provide pre-paid return label or pick-up service for customer's convenience.

Note: Please disassemble the item before you return it, otherwise there will be a huge cost as oversized and it could even exceed your order amount.

Please do not purchase return labels for a damaged defective item by yourself.

If you have any problem to return the item please contact us immediately we will do our best to help you.

IX . CARE AND MAINTENANCE

- We recommend covering the product under extreme weather outdoors.
- Due to the characteristics of wood and the gap between the boards, in order to prolong the service life of the product, we recommend that you regularly coat a waterproof oil and sealant on the product.

X. MCOMBO CUSTOMER CENTER

If for any reason we have fallen short of your expectations or if you have any questions and suggestions please refer to the following to contact us, we will do our best to work with you to make sure you are entirely satisfied.

	Kreuzweg 60, 47809 Krefeld, Germany
	pfillo.de@gmail.com www.mcombo.de

If there is any problem with the product, how to solve it?

In order to efficiently help you solve the problem, please let us know your **order number, the part number of the defective/missing part, the quantity of the issue parts, and send some pictures** when contacting us. They can effectively assist us to solve the problem for you quickly.



mcombo.de



[MCombo - Amazon.de](https://MCombo-Amazon.de)