



Output	390 - 455 lumen
Beam Angle	10°, 25°, 36°
Color Temperature	2700K, 3000K, 4000K
Color Metrics	CIE Metrics: CRI 95, R9 95 TM30 Metrics: Rf 95, Rg 100 Whiteness Index: Rw 100
Applications	Hotels & Hospitality Galleries & Museums High-End Retail



SORAA VIVID™

Soraa VIVID lamps offer beautiful and accurate color and white rendering across the entire visible spectrum, mimicking the natural range of sunlight to deliver unmatched quality of light for color critical applications.

POINT SOURCE OPTICS™

Point Source Optics deliver exceptional beam quality with crisp shadows, perfect uniformity and precisely controlled beam distributions from 10° to 36°.

SORAA VIVID COLOR™

Soraa VIVID lamps utilize full spectrum light to provide industry-leading color rendition of CRI/95, R9/95, Rf/95, Rg/100 for precise color reproduction.

SORAA NATURAL WHITE™

Soraa VIVID lamps are engineered to deliver outstanding whiteness rendering for true-to-life whites, which matches or exceeds incandescent sources at 2700K and 3000K.

ENERGY EFFICIENCY

85% more energy efficient than standard halogen lamps, with typical payback of one year or less.

GENERAL SPECIFICATIONS

Form Factor	Operating Temperature	Electrical	Dimming
Width: 50.1mm (1.97")	Minimum: -40°C (ambient)	Wattage: 7.5W	Please reference our compatibility chart for dimmer and transformer information.
Height: 45.5mm (1.79")	Typical: 85°C-90°C (base)	Power factor: 0.92	
Weight: 47g	Maximum: 90°C (base)	Voltage: 12V +/- 1.2V	
		Frequency: 50/60Hz	

THERMAL COMPATIBILITY

Suitable for use in fully enclosed fixtures, subject to the maximum heatsink temperature limits stated in this data sheet. Designed to safely turn down in high temperature environments to protect LED and components.

ELECTRICAL COMPATIBILITY

Works with trailing edge and leading edge phase cut dimmers, 12V AC magnetic and electronic transformers and 12V DC transformers. Check individual lamp website pages for compatibility data. For more information visit: www.soraa.com.

INTENDED USE & LOCATION RATING

Intended for use in MR16 compatible recessed downlights, track lighting and other indoor and outdoor applications. Suitable for damp locations, not rated for use in wet locations.

This light source produces greater than 2mW/klm of UV light and is intended only for high color and white rendering applications, where the UV light is required to activate optical brightening agents in illuminated objects.

LIFETIME & WARRANTY

Rated lifetime to L70: 35,000hrs
Warranty: 3yrs or 25,000hrs whichever comes first
For warranty information visit: www.soraa.com/resources/legal.

ACCESSORIES

Narrow spot compatible with the Soraa SNAP System™.



DIMENSIONS

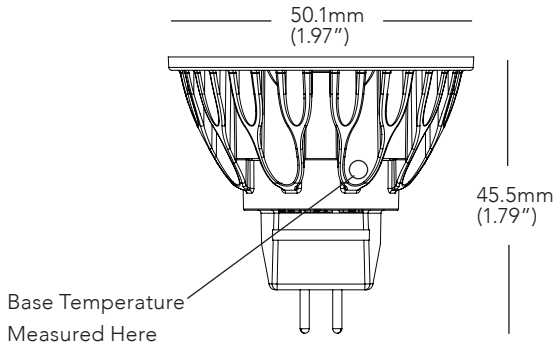

COLOR RENDERING

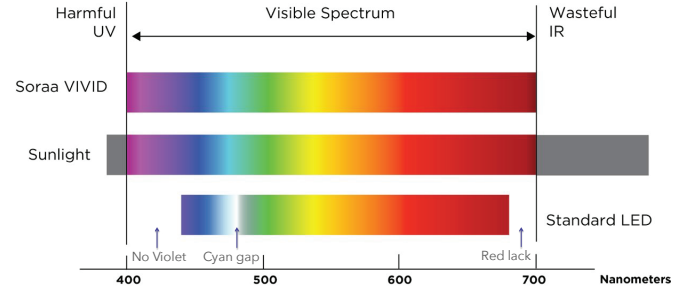

10 DEGREE BEAM

Beam Dia at 50% CBCP (ft)	Field Dia at 10% CBCP (ft)	Foot-candles (% of CBCP)
0.5	1.1	11.1%
1.0	2.1	2.8%
1.6	3.2	1.2%
2.1	4.2	0.7%
2.6	5.3	0.4%

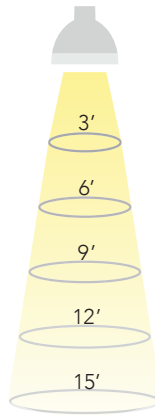

25 DEGREE BEAM

Beam Dia at 50% CBCP (ft)	Field Dia at 10% CBCP (ft)	Foot-candles (% of CBCP)
1.3	2.1	11.1%
2.7	4.1	2.8%
4.0	6.2	1.2%
5.3	8.3	0.7%
6.7	10.3	0.4%

36 DEGREE BEAM

Beam Dia at 50% CBCP (ft)	Field Dia at 10% CBCP (ft)	Foot-candles (% of CBCP)
1.9	3.1	11.1%
3.9	6.1	2.8%
5.8	9.2	1.2%
7.8	12.2	0.7%
9.7	15.3	0.4%

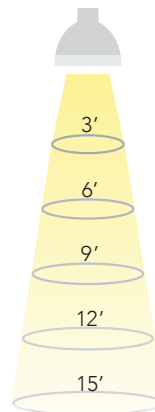

Note: Footcandles may be calculated by multiplying the CBCP of the desired model number by the percentage in the tables above

SPECIFICATIONS BY MODEL NUMBER* SORAA LED MR16 GU5.3 7.5W 12V

Model #	Product Code	CCT (K)	Beam Angle	Field Angle	CBCP (Cd)	Total Flux (Lm)	90° Lumens	Efficacy (Lm/W)	McA	SNAP
VIVID SERIES										
SM16-07-10D-927-03	00919	2700	10	20	5710	390	345	52	3	YES
SM16-07-25D-927-03	00931	2700	25	40	2260	410	385	55	3	-
SM16-07-36D-927-03	00943	2700	36	57	1070	410	375	55	3	-
SM16-07-10D-930-03	00923	3000	10	20	6000	410	360	55	3	YES
SM16-07-25D-930-03	00935	3000	25	40	2400	435	410	58	3	-
SM16-07-36D-930-03	00947	3000	36	57	1130	435	400	58	3	-
SM16-07-10D-940-03	00925	4000	10	20	6290	430	380	58	4	YES
SM16-07-25D-940-03	00937	4000	25	40	2510	455	430	61	4	-
SM16-07-36D-940-03	00949	4000	36	57	1190	455	415	61	4	-

CCT: Correlated Color Temperature **McA:** White Point Accuracy in McA step **SNAP:** SORAA SNAP System Compatible

*Specifications are at stable warm operating conditions (25°C ambient)

CCT

SPECTRAL POWER DISTRIBUTION

COLOR QUALITY METRICS

COLOR ACCURACY

**VIVID
2700K**

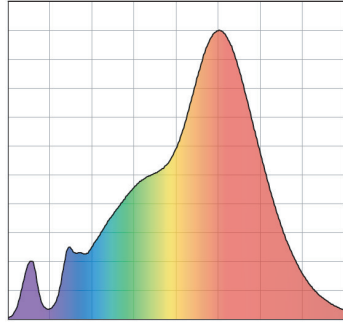

CRI: 95, R9: 95

CRI 95

R9 95

Rf 95

Rg 100

Rf-h1 95

Rw 90

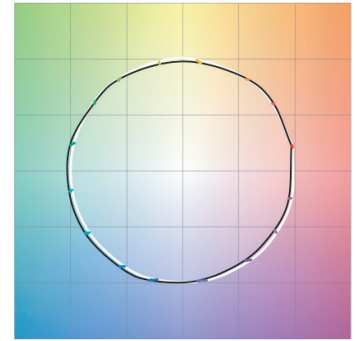

**VIVID
3000K**

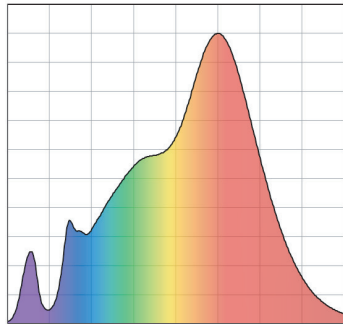

CRI: 95, R9: 95

CRI 95

R9 95

Rf 95

Rg 100

Rf-h1 95

Rw 90

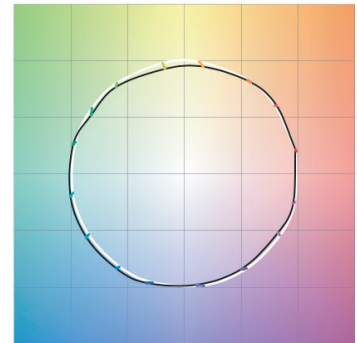

**VIVID
4000K**

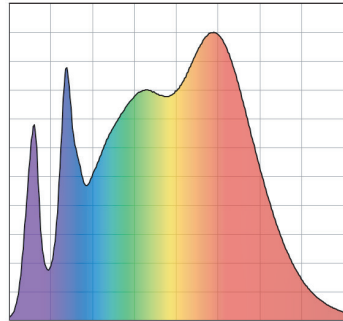

CRI: 95, R9: 95

CRI 95

R9 95

Rf 98

Rg 100

Rf-h1 100

Rw 100

