

Art. Nr. 2816201
1/13



29.05.2018

Art. Nr. 2816201

Groundplan - Grundplan - Plan de masse - Planimetria -
Plattegrond - Põhiplaan

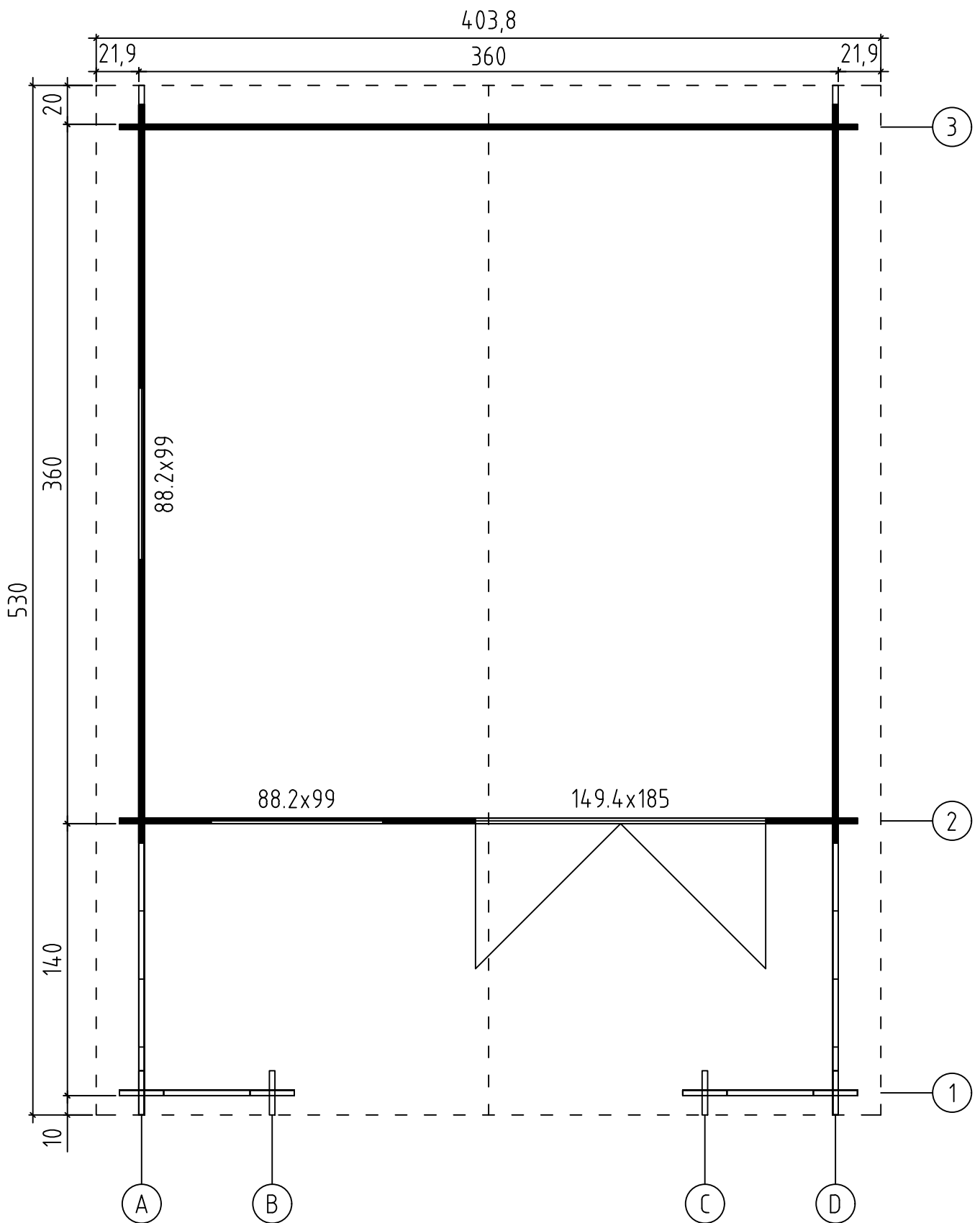

Art. Nr. 2816201

Foundation - Fundament - Fondation - Fundamenta -
Fundering - Immutatud alusraam

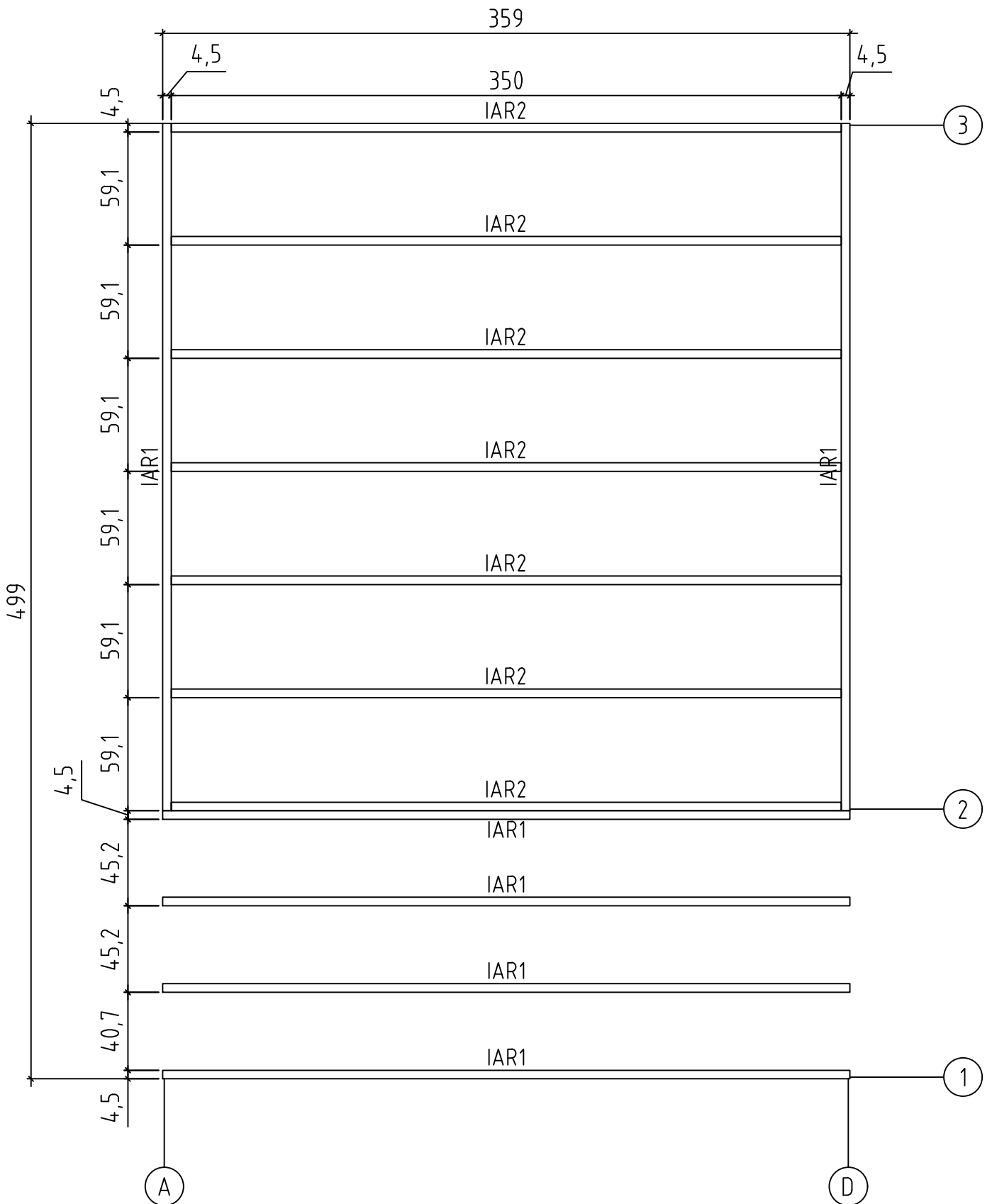

Art. Nr. 2816201

Floor boards - Fussbodenbretter - Plan pose plancher -
Pavimento - Vloerhout - Põrandalaudis

Terrace boards - Terrassenbretter - Plancher de terrasse -
Piattaforme terrazzo - Terrasvloer - Terrassilaud

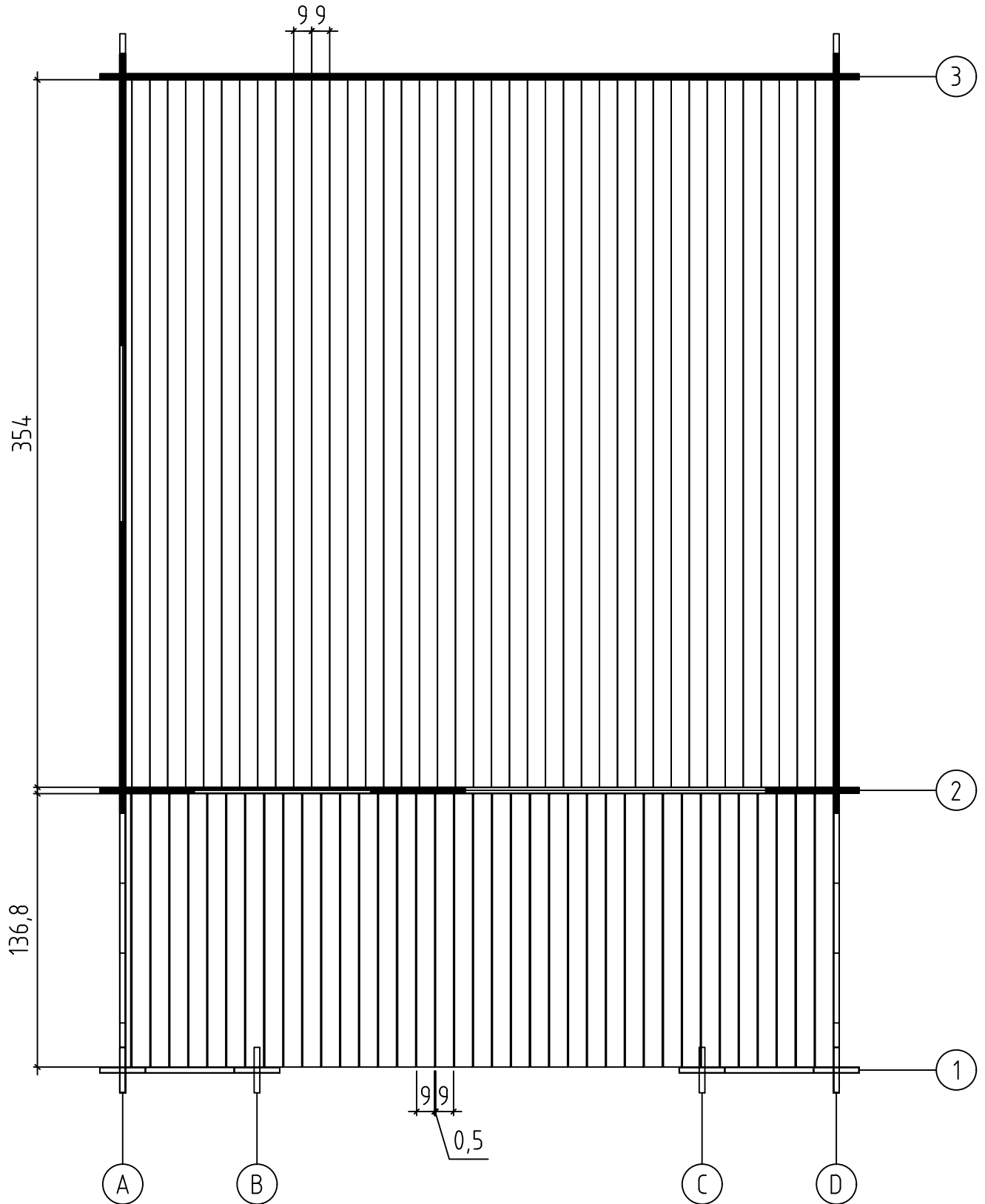

Art. Nr. 2816201

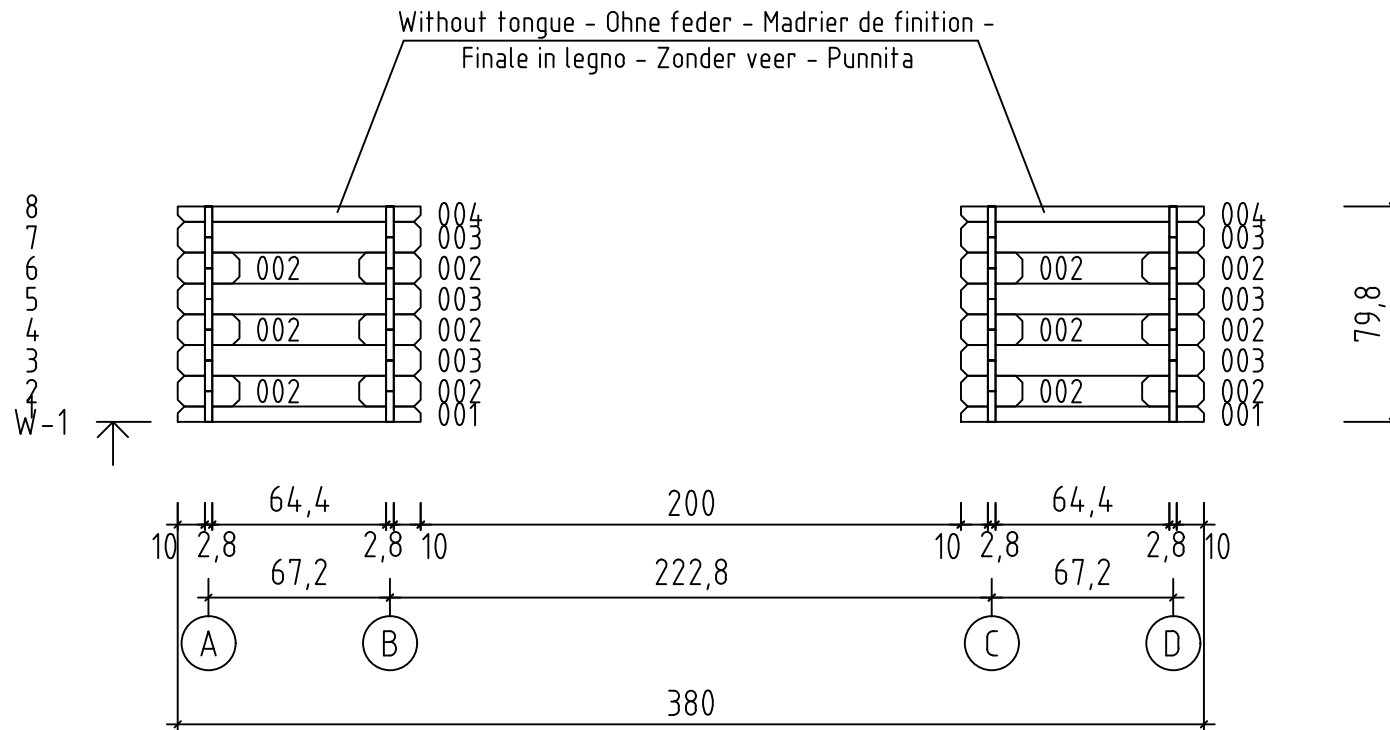

Art. Nr. 2816201

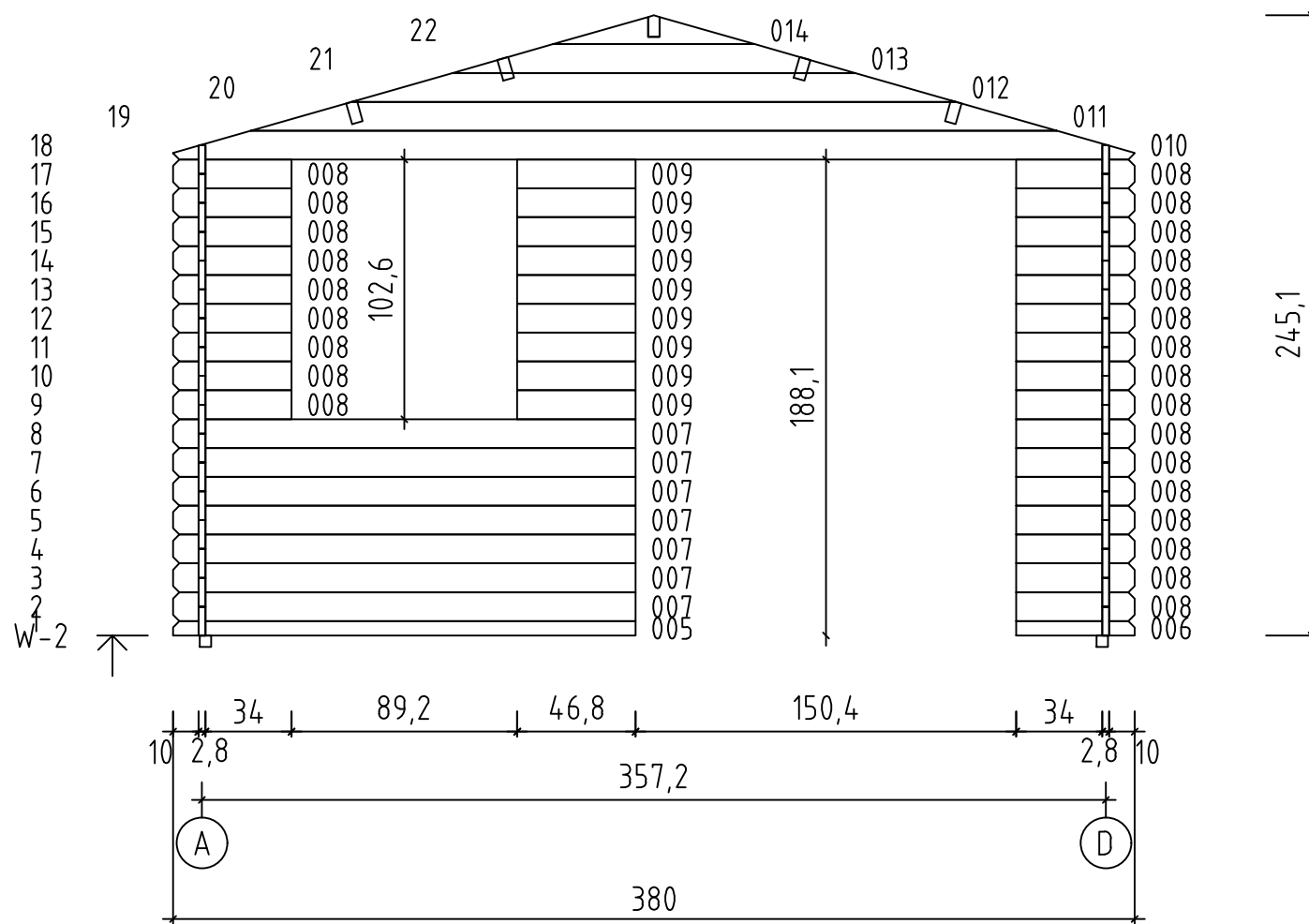

Art. Nr. 2816201

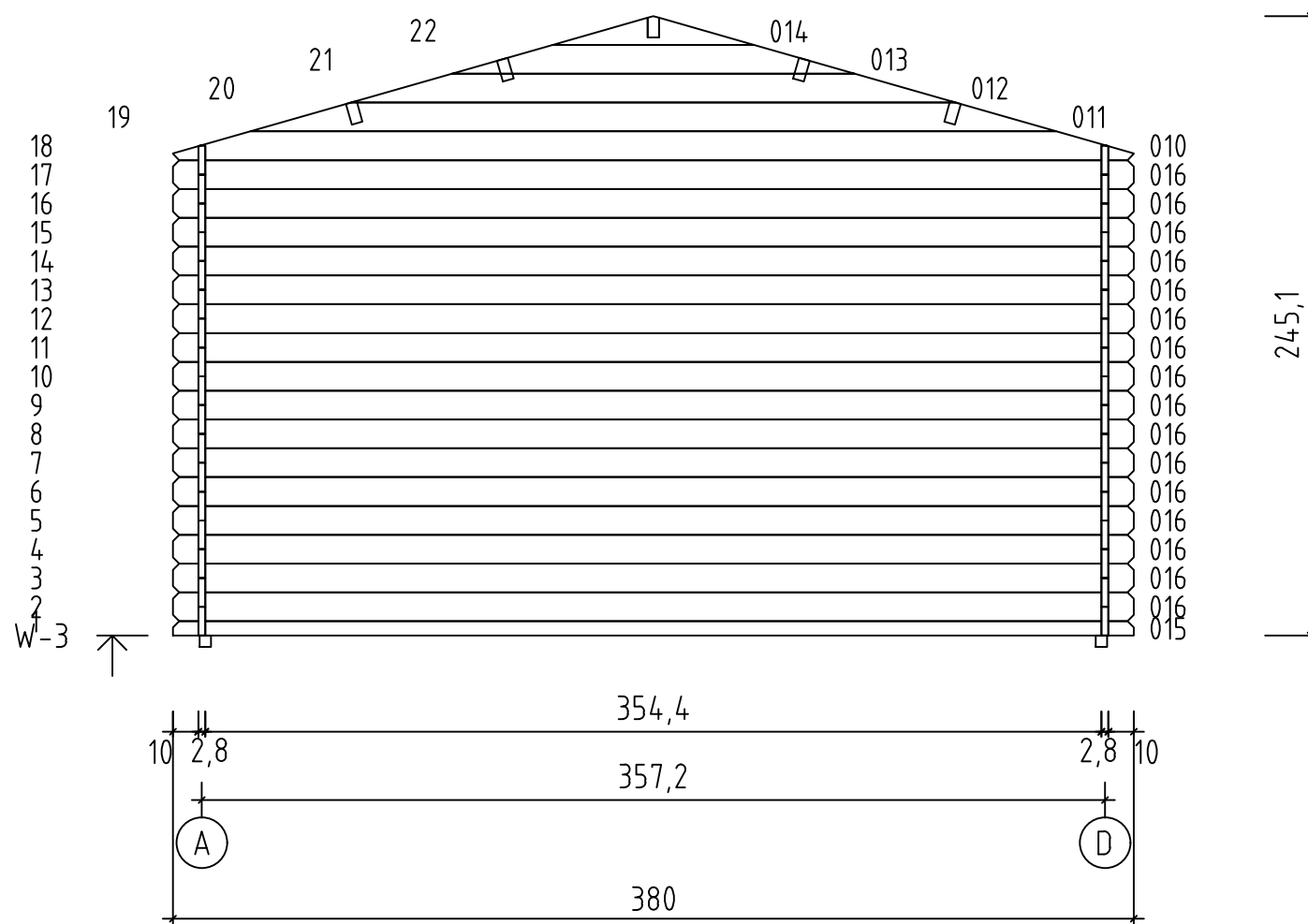

Art. Nr. 2816201

530

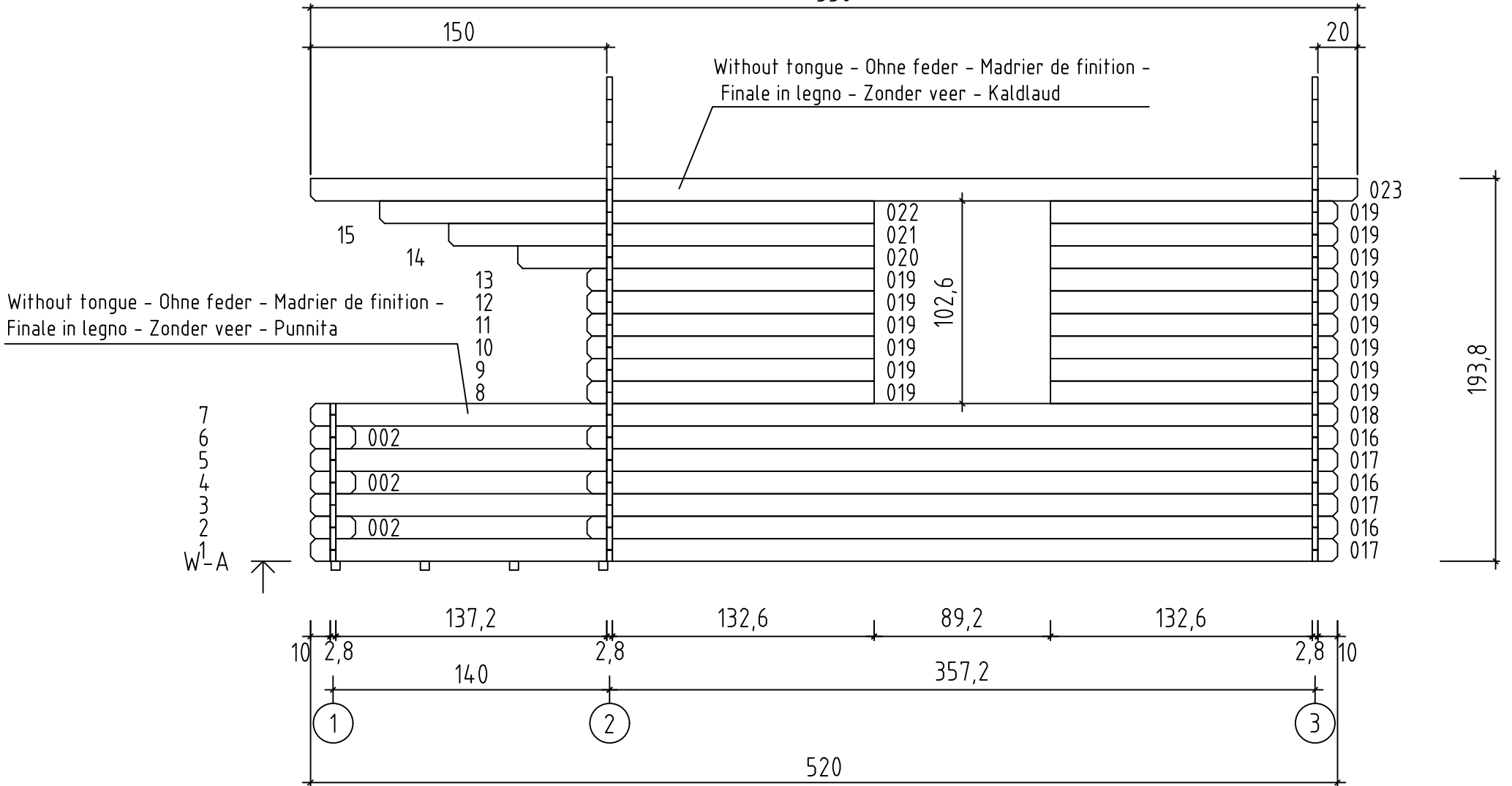



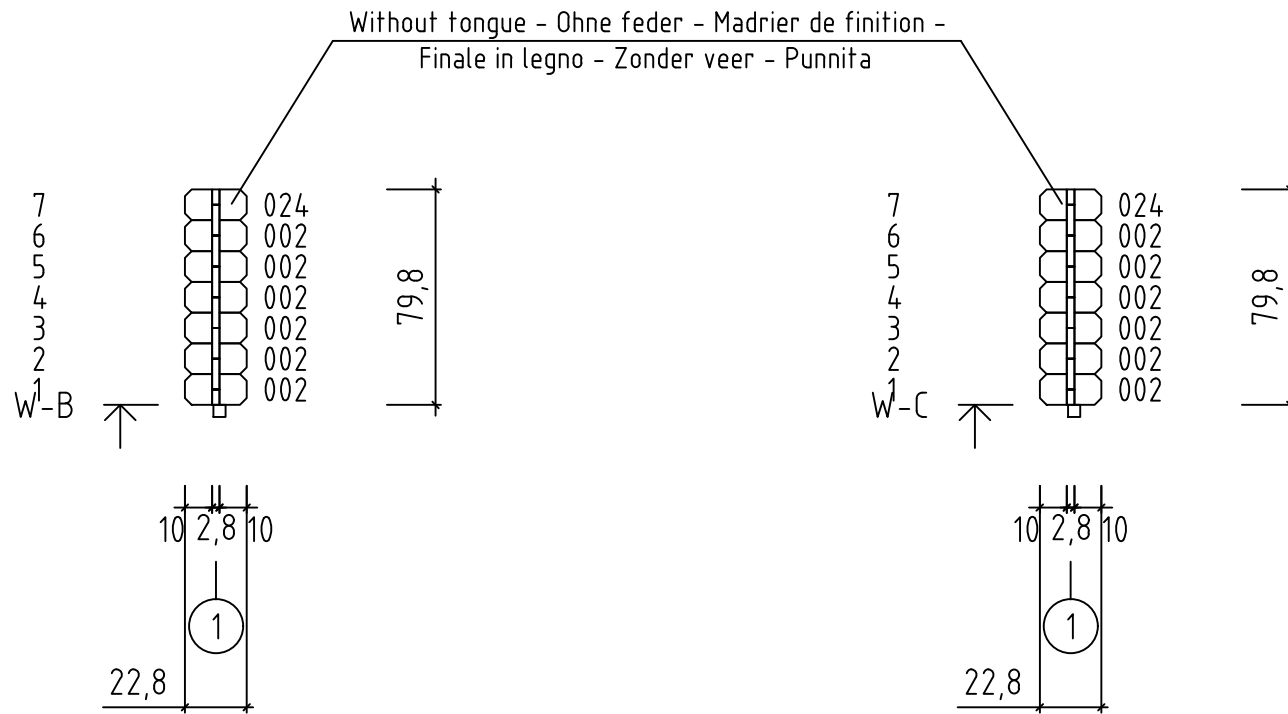





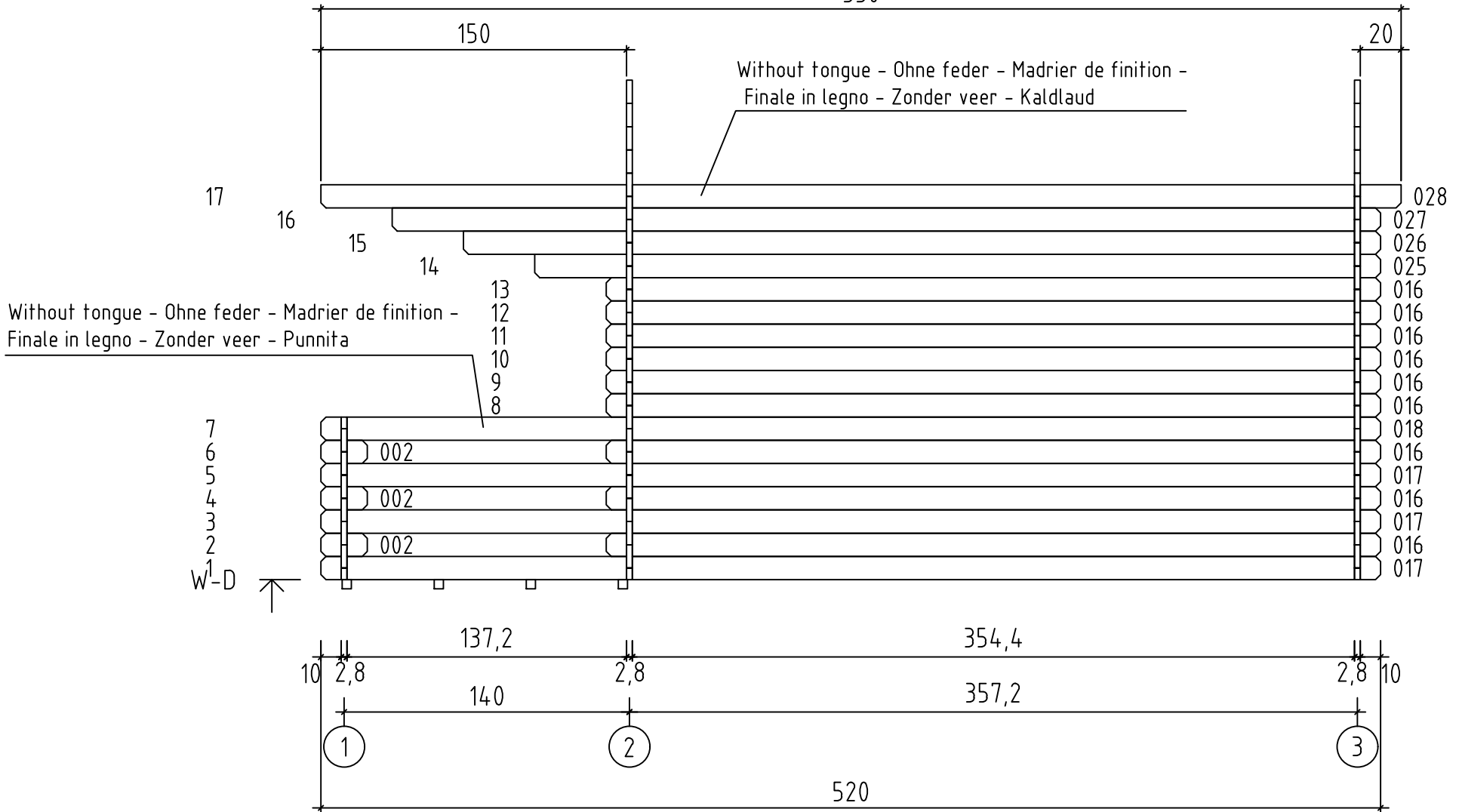

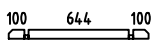
Art. Nr. 2816201

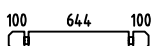
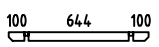
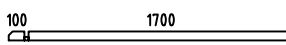

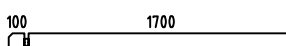

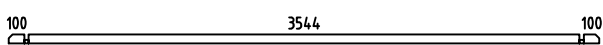
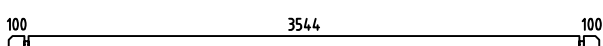
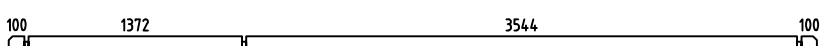
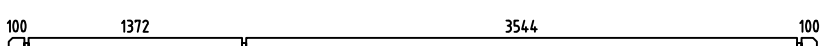
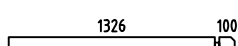
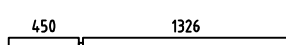
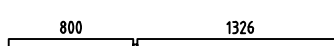
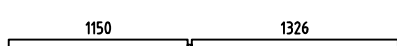

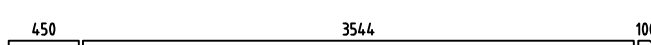

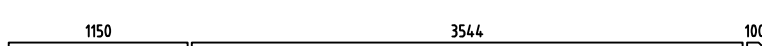
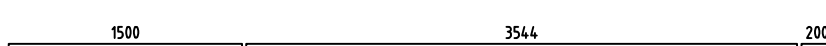



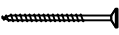

Art. Nr. 2816201

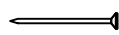

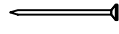
530

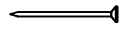
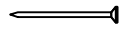

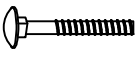



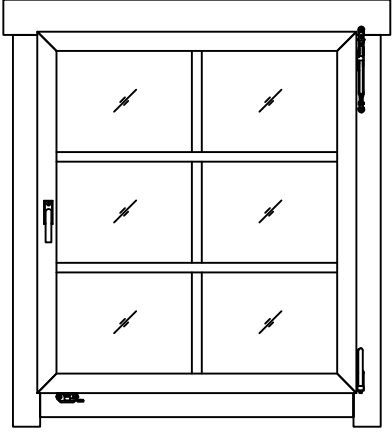
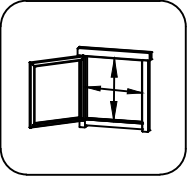
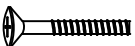

Pos	29.05.2018 Piece list - Stückliste - Liste des pièces - Elementi - Stuklijst - Tükítabel Art. Nr. 2816201 11/13	Q	P (mm)	L (mm)
001		2	28x57	900
002		30	28x114	228
003		6	28x114	900
004		2	28x53	900
005		1	28x57	1828
006		1	28x57	468
007		7	28x114	1828
008		25	28x114	468
009		9	28x114	468
015		1	28x57	3800
016		28	28x114	3800
017		6	28x114	5200
018		2	28x114	5200
019		15	28x114	1454
020		1	28x114	1804
021		1	28x114	2154
022		1	28x114	2504
023		1	28x120	5300
024		2	28x110	228
025		1	28x114	4150
026		1	28x114	4500
027		1	28x114	4850
028		1	28x120	5300

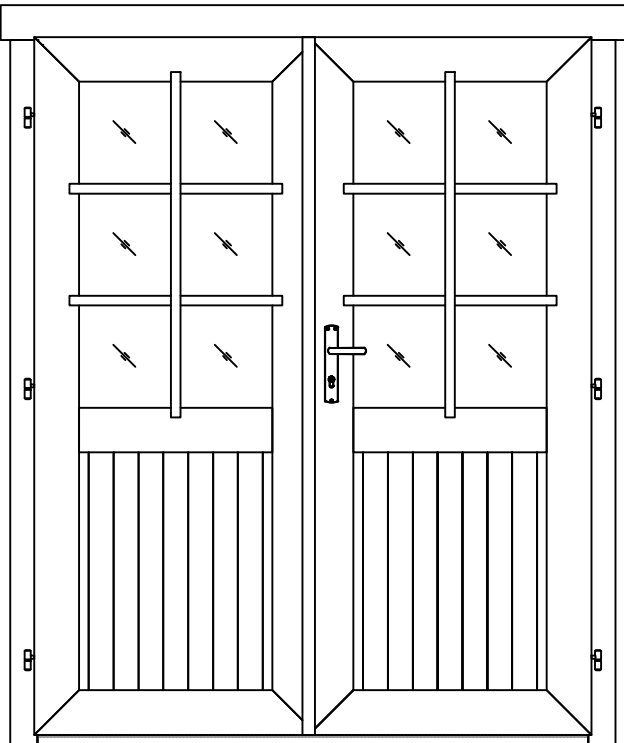
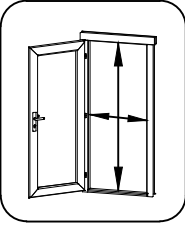
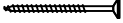
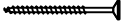
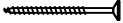
Pos	29.05.2018 Piece list - Stückliste - Liste des pièces - Elementi - Stuklijst - Tükitalabel Art. Nr. 2816201 12/13	Q	P (mm)	L (mm)
W2-1		1		
W3-1		1		
IAR1	Foundation - Fundament - Fondation - Fondamenta - Fundering - Immutatud alusraam 	6	45x45	3590
IAR2	Foundation - Fundament - Fondation - Fondamenta - Fundering - Immutatud alusraam 	7	45x45	3500
A-PR1	Roof beam - Dachbalken - Panne de toit - Perlina del tetto - Gordingen / dakbalk - Pärilin 	5	44x140	5300
	Floor boards - Fussbodenbretter - Lame de plancher - Pavimento - Vloerhout - Põrandalaud 	40	90x18	3540
	Terrace boards - Terrassenbretter - Plancher de terrasse - Piattaforme terrazzo - Terrasvloer - Terrassilaud 	38	90x19	1368
	Roof boards - Dachbretter - Voliges - Perlina per tetto - Dakhout - Katuselaud 	118	90x18	2100
	Floor fillet - Fussbodenleiste - Corniere de finition du plancher - Finitura per pavimento (battisco pa) - Vloerafwerklijs - Põrandaliist 		18x18	14.16
	Roofing felt fillet - Dachpappenleiste - Bague de fixation du feutre bitumeux - Asse per fissaggio guaina bituminosa - Afdekljst asfaltpapier - Katusepapiliist 	4	18x58	2150
DPP-1	Roofing felt (strip) - Dachpappe (bahnen) - Feutre bitumeux (bande) - Cartone catramato - Asfaltpapier (baan) - Katusepapp 	5		5400
TB-1	Fascia board - Traufbrett - Bandeau de toit - Finitura lati tetto - Gevellijs - Räästalaud 	4	18x90	2650
DRV-1	Roof edge reinforcement - Dachrandverstärkung - Corniere de renfort de bord de toit - Rinforzo x tetto - Dakrand versterking - Räästafugevdus 	4	28x34	2650
	Terrace edge board - Terrassenbrett, eingang - Lame de seuil d'entree de terrasse - Terrazzo uso abitacolo - Terrasvloer dorpel - Terrassi servaliist 	1	19x28	2000
	Guard-rail for terrace - Terrassengeländer - Main courante de terrasse - Guardrail per terrazzo - Terras leuning - Terrassi äärelaud 	2	18x90	831
	Guard-rail for terrace - Terrassengeländer - Main courante de terrasse - Guardrail per terrazzo - Terras leuning - Terrassi äärelaud 	2	18x90	1331
KFS-1	Storm protection - Sturmleiste - Latte anti-tempete - Protezione anti vento - Stormverankering / beveiliging - Tormikinnitusliist 	4	22x45	2050
	Gable moulding - Giebelleiste - Planche de rive - Finitura per frontale e retro del tetto - Gevellijs - Viilulaud 	4	18x120	2150
HS8	Screw for gable segment - Schrauben für deckblatt - Vis pour fixation losange de finition - Viti x frontali tetto - Schroef voor gevelpunt segment - Kruvi rombile 	4	3.5x35	
HS9	Screw for gable moulding - Schrauben für giebelleiste - Vis pour fixation planche de rive - Vite per fissare finiture davanti e dietro del tetto - Schroef voor gevellijs - Kruvi viilulauale 	32	3.5x50	
HS12	Screw for fascia boards - Schrauben für traufbretter - Vis pour fixation bandeau de toit - Viti x striscia del tetto - Schroef voor gevellijs - Kruvi räästalauale 	24	4x40	

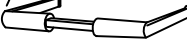
Pos	29.05.2018 Piece list - Stückliste - Liste des pièces - Elementi - Stuklijst - Tükítabel Art. Nr. 2816201 13/13	Q	P (mm)	L (mm)	
HS12	Screw for roof edge reinforcement - Schrauben für Dachrandverstärkung - Vis pour fixation cornière renfort de bord de toit - Viti x rinforzo bordo tetto - Schroef voor dakrand versterking - Kruvi räästatugevdusele		24	4x40	
HS12	Screws for terrace edge board - Schrauben für Terrassenbrett - Vis de fixation de lame de seuil d'entrée de terrasse - Vite per unire delle assi del terrazzo - Schroeven voor terrashout - Kruvi terrassi servaliistule		5	4x40	
HS12	Screw for terrace rear boards - Schrauben für Terrassenrand - Vis de fixation pour main courante de terrasse - Vite per il piano posteriore della terrazza - Schroef voor terras afsluitplint (achterzijde) - Kruvi terrassi äärelaualae		16	4x40	
HS18	Screw for roof beams - Schrauben für Dachbalken - Vis pour fixation pannes de toit - Viti per perline del tetto - Schroef voor gordingen / dakbalken - Kruvi pärlinitelae		14	5x120	
HS16	Screw for 1. wall beam - Schraube für 1. Bohlenreihe - Vis de fixations 1ere rangée de madriers avec poutrelles de fondations - Vite fissaggio alle fondamenta - Schroef voor 1 wandbalk - Kruvi poolaualae		12	5x90	
HS16	Screw for foundation - Schrauben zur Befestigung Fundament - Vis de fixations des poutrelles de fondations - Viti x fondamenta - Schroef voor fundering - Kruvi alusraamile		19	5x90	
NF2	Zn nail for floor fillet - Zn Nägel für Fussbodenleiste - Pointe pour cornière de finition du plancher - Chiodi x fissaggio pavimento - Spijker(nagel) voor vloer afdekljst - Nael põrandaliistule		29	1.4x40	
	Flower box - Blumenkasten - Jardiniere - Fioriera - Bloembak - Lillekast		1		
SH28	Hammer block - Schlagholz - Calle de frappe - Blocco di legno da usare come cuscinetto quando si usa il martello - Slagklos - Löögiklots		1		
SFS	Nut for storm protection - Schraubenmutter für Sturmleiste - Ecrou pour latte anti-tempete - Dado x asta protezione vento - Moer voor stormverankering - Mutter tormikinnitusliistule		8	D6	
NF3	Zn nail for terrace - Zn Nägel für Terrassenbretter - Pointe pour plancher de terrasse - Chiodo zincato per terrazza - Spijker(nagel) voor terrasvloer - Nael terrasilauale		288	2.1x50	
NF4	Zn nail for roof - Zn Nägel für Dachbretter - Pointe pour fixation voliges de toit - Chiodi x perline tetto - Spijker(nagel) voor dakhout - Nael katuselauale		480	2x50	
NF4	Zn nail for floor - Zn Nägel für Fussbodenbretter - Clous pour plancher - Chiodi x perline pavimento - Spijker(nagel) voor vloer - Nael põrandalauale		287	2x50	
NF5	Zn nail for roofing felt fillet - Zn Nägel für Dachpappenleiste - Pointe pour baguette de fixation feutre bitumeux - Chiodi x carta bituminosa x tetto - Spijker(nagel) voor asfaltpapier afdekljst - Papiliistunael		20	2x40	
NF6	Roofing nails for roofing felt - Nägel für Dachpappe - Pointe pour fixation feutre bitumeux - Chiodi per cartone catramato - Asfaltnagel - Papinael		259	2.8x15	
BFS	Bolt for storm protection - Bolzen für Sturmleiste - Boulon pour latte anti-tempete - Bullone x asta protezione vento - Bout voor stormankerlat - Puidupolt tormikinnitusliistule		8	6x60	
GS	Gable segment - Deckblatt - Losange de finition - Decorazione in legno x frontale tetto - Gevelpunt segment - Romb		2		
DFS	Washer for storm protection - Dichtscheibe für Sturmleiste - Rondelle pour latte anti-tempete - Rondella x asta protezione vento - Afdichtring voor storm strip - Seib tormikinnitusliistule		8	D6	
	Window - Fenster - Fenetre - Finestra - Raam - Aken	882x990 AK.1.106.SSP.a SGC	2		
	Door - Tür - Porte - Porte - Deur - Uks	1494x1850 TUK.2.056.SVP.MMc SGC	1		

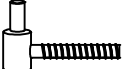
Pos	06.09.2016 Piece list - Stückliste - Liste des pièces - Elementi - Stuklijst - Tükítabel 882x990 AK.1.106.SSP.a SGC	1/1	Q	P (mm)	L (mm)
	<p data-bbox="263 152 1284 183">Glass size - Glasgröße - Taille de la vitre - Misura del vetro - Glas afmeting - Klaasi mõõt: 738x846 mm</p>   <p data-bbox="1369 347 1492 376">782x890 mm</p>				
FS1	<p data-bbox="263 1953 1029 2011">Window handle fittings - Fenstergriff - Poignée de fenetre - Maniglia c/ferramenta - Raamhendel -/grendel -/klink - Aknalink</p>		1		
FSP	<p data-bbox="263 2033 1109 2110">Bolt for window handle fittings - Bolzen für fenstergriff beschlag - Vis pour fixation poignée de fenetre - Bullone x apertura manuale finestra - Schroef voor raamhendel - Akna käepideme polt</p>		2		
HS1	<p data-bbox="263 2123 1109 2199">Screw for georgian bars - Schraube für sprossen - Vis pour croisillons - Viti per unire la griglia georgiana della finestra - Schroeven voor raamverdeling - Kruvi akna petfeliistule</p>		6	2.5x20	

Pos	13.01.2017	Piece list - Stückliste - Liste des pièces - Elementi - Stuklijst - Tükítabel 1494x1850 TUK.2.056.SVP.MMc SGC	1/1	Q	P (mm)	L (mm)
		Glass size - Glasgröße - Taille de la vitre - Misura del vetro - Glas afmeting - Klaasi mõõt: 514x855 mm				
		  <p>1394x1768 mm</p>				
HS1	Screw for georgian bars - Schraube für sprossen - Vis pour croisillons - Viti per unire la griglia georgiana della finestra - Schroeven voor raamverdeling - Kruvi ukse peffeliistule		12	2.5x20		
HS4	Screw for door fillet - Schraube zur befestigung türleiste - Vis pour fixation baguette d'arret de porte - Viti per massellino della porta - Schroef voor deurlijst - Kruvi ukse kokkuvaltsiliistule		5	3x30		
HS16	Screw for door jamb - Schraube für türrahmen - Vis de fixation partie haute avec montants du cadre de porte - Viti x fissaggio montanti porte - Schroef voor deurkozijn - Kruvi ukse lengile		4	5x90		
HS25	Screw for doorstep - Schrauben für swelle - Vis pour fixation barre de seuil - Vite per soglia della porta - Schroef voor deurdorpel - Kruvi lävepakule		3	4.5x65		
TL4	Door handle fittings - Türgriff - Poignée de porte - Maniglie - Deurhendel / klink - Ukse käepide VU		1			
TL5	Set of door lock covers - Schlossblenden - Set de garnitures de porte - Copertura serrature - Slot sluitplaat set - Ukse lukuplaat		1			
	Cylinder lock - Zylinderschloss - Barillet de porte - Serratura - Cylinder slot - Ukse lukusüdamik		1	30x35		
	Male bolt hinge for door - Türband - Partie male de paumelle de porte - Cerniera anube x porta - Scharnier bout - Ukse polthing isane		6			
	Striker for barrel bolt - Hülse für grendelriegel - Gache au sol du targette - Boccola per fermo della porta - Huls voor vergrendelingsschuif - Vasturaud ukse servariivile		2			

Pos	02.07.2012	Piece list - Stückliste - Liste des pièces - Elementi - Stuklijst - Tükítabel Flower box - Blumenkasten - Jardiniere - Fioriera - Bloembak - Lillekast Art.Nr. 990600	1/1	Q.	P (mm)	L (mm)
ES1				1	18x90	906
ES2				1	18x90	884
TS				1	18x140	846
PL				3	18x140	201
KL				2	18x140	200
SH100	Screw for flower box - Montagschraube für blumentasten - Vis assemblage des jardinières - Viti per fioriera - Montageschroeven voor bloembak - Kruvi lillekasti montaažiks			28	3.5x50	
SH100	Screw for fixing flower box to the walls - Schraube zur Befestigung den blumenkasten - Vis de fixation au mur des jardinières - Viti per fissare la fioriera alle pareti - Schroeven voor bevestiging bloembak met wand - Kruvi lillekasti kinnitamiseks seinale			3	4x40	

