

TORINO

Wohnlandschaft links

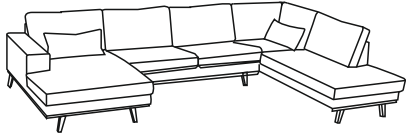

45 min

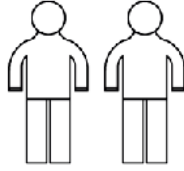

- | | |
|----------------------------------|------------------------------|
| (D) Montageanleitung | (GB) Assembly instructions |
| (FR) Notice de montage | (IT) Istruzioni di montaggio |
| (NL) Handleiding voor de montage | (PL) Instrukcja montażu |
| (CZ) Montážní návod | (SK) Návod na montáž |
| (HU) Szerelési útmutató | (RO) Instrucțiuni de montaj |
| (TR) Montaj talimatı | (RU) Инструкция по монтажу |

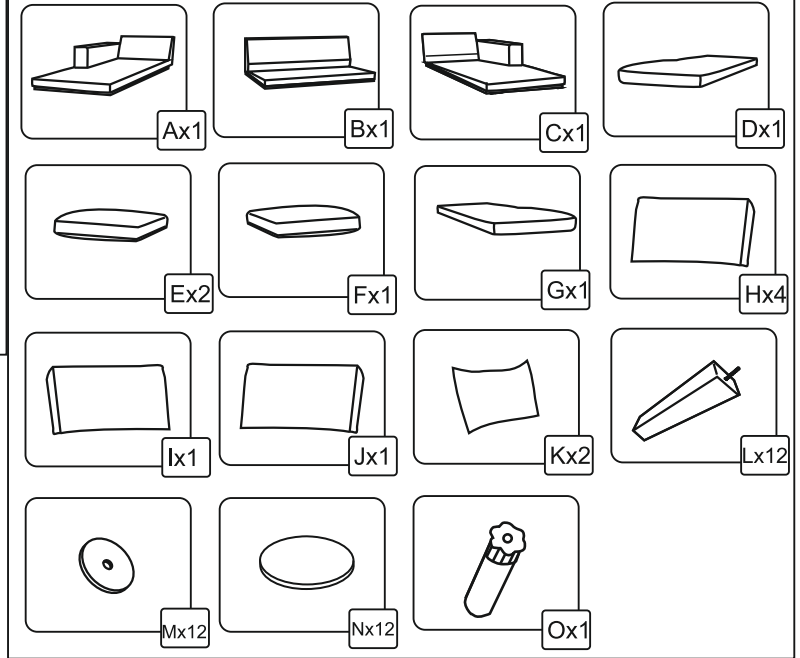
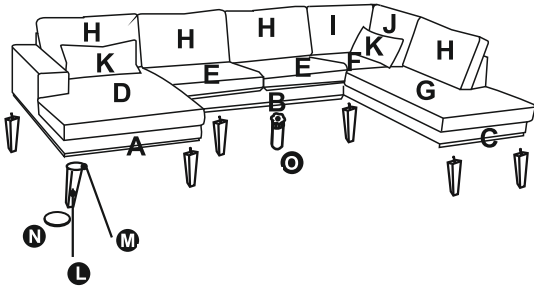

1

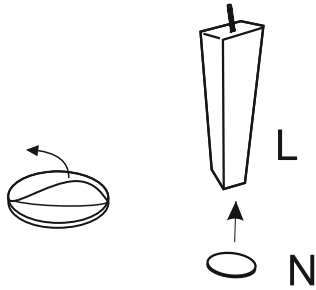

2

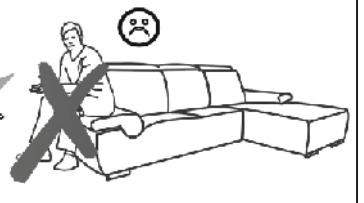
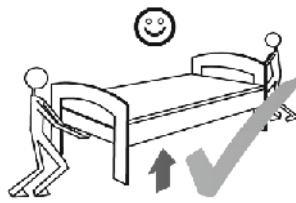
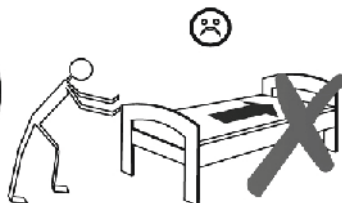
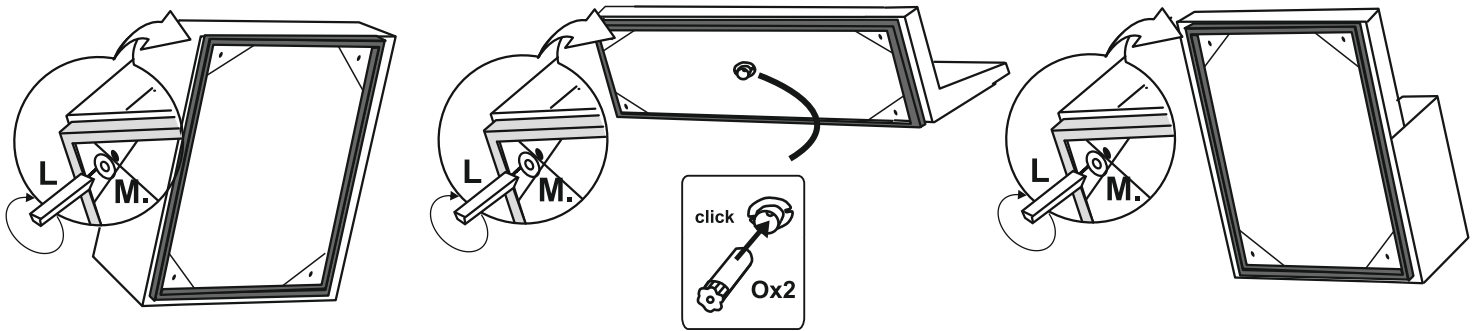

3

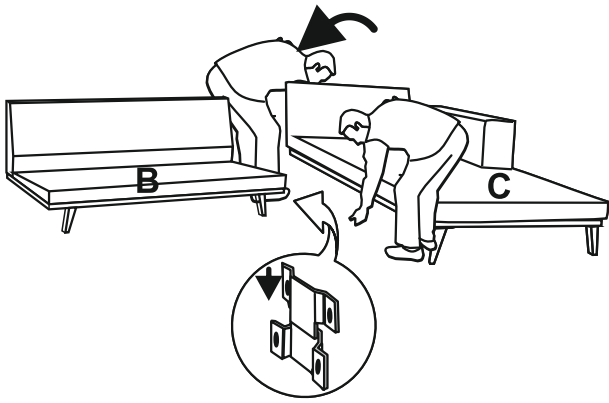

4

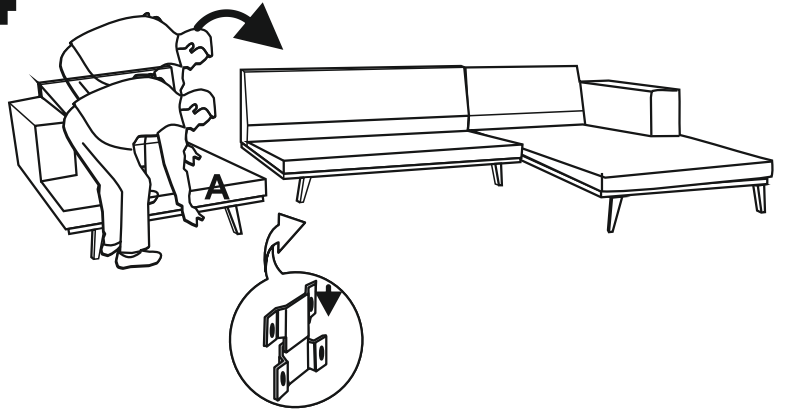

5

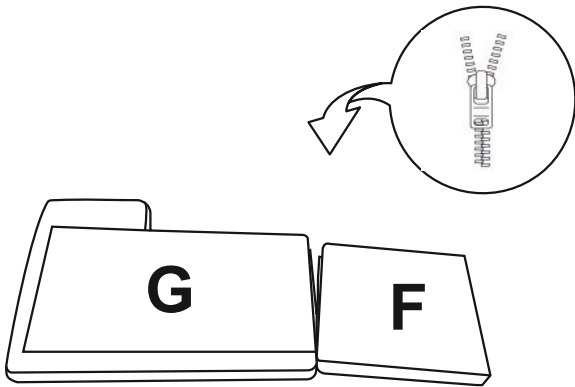

6

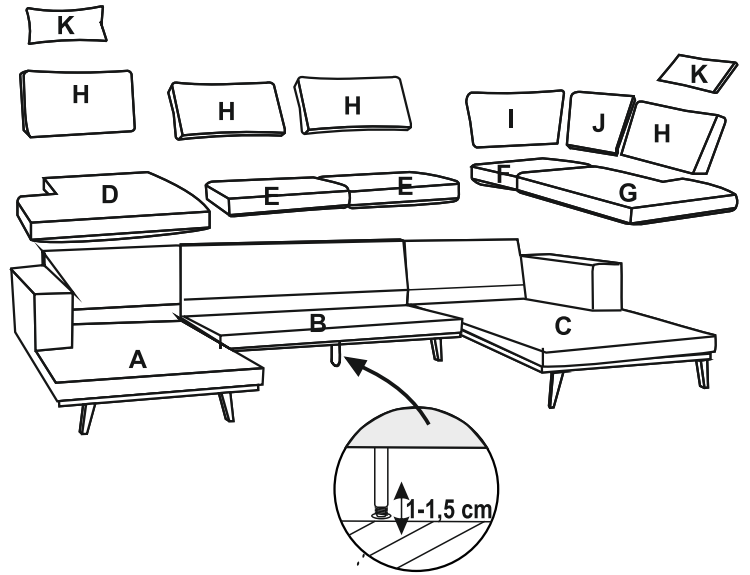

**Service • Assistenza • Dienstverlening • Serwis
Servis • Szerviz • Сервисная служба**

Name • Nom • Nome • Naam •
Nazwa • Jméno • Názov • Név • **TORINO**
Denumire • Isim • Название

Nr • No. • N° • Номер • Č • Sz

Typ • Type • Tip • Típus • Tipo •
Тип

