

Nebbio

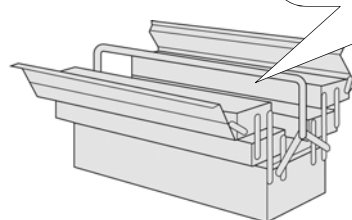

- | | |
|----------------------------------|---------------------------------------|
| D Montageanleitung | GB Assembly instructions |
| FR Notice de montage | NL Handleiding voor de montage |
| CZ Montážní návod | IT Istruzioni di montaggio |
| RO Instrucțiuni de montaj | RU инструкция по сборке |
| PL Instrukcja montażu | SK Návod na montáž |
| HU Szerelési útmutató | TR Montaj talimati |

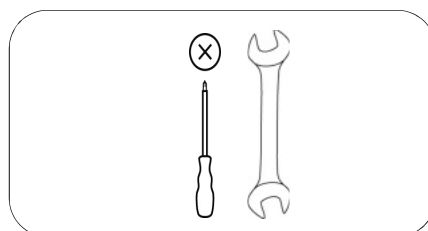

0
10
20
30
40
50
60
70
80
90
100
110
120
130
140
150
160
170
180
190
200

Service • Assistenza • Dienstverlening • Serwis Servis • Szerviz • Сервисная служба	
Name • Nom • Nome • Naam Nazwa • Jméno • Názov • Név Denumire • Ísim • Название	Nebbio EB
Nr. • No. • N° • Номер • Č • Sz	SH46
Typ • Type • Tip • Típus • Tipo Тип	OHNE

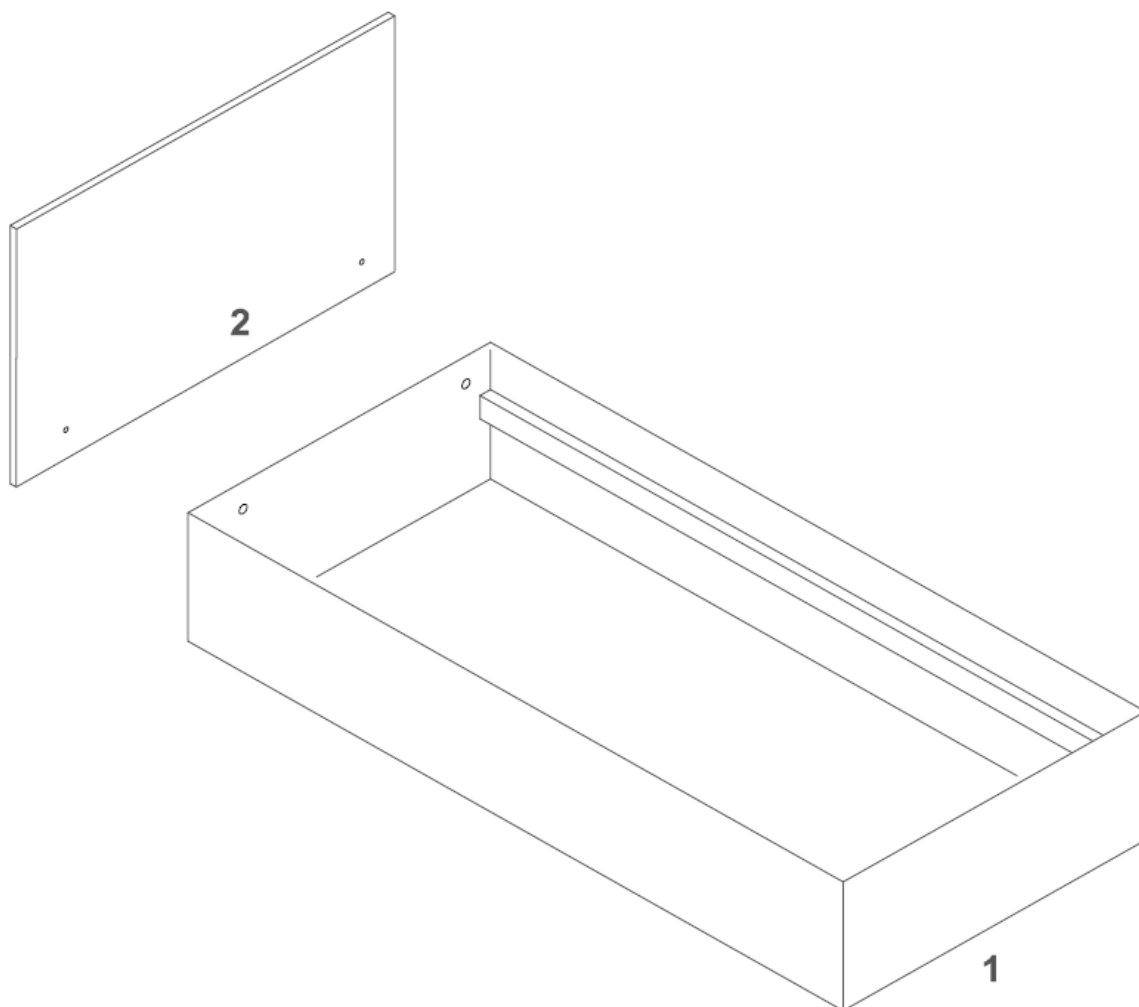

A	B	C	D	E	F	G	H
4x	4x 8x50	4x 10x80	4x 8x20	2x	2x 8x60	2x 8x40	2x M8



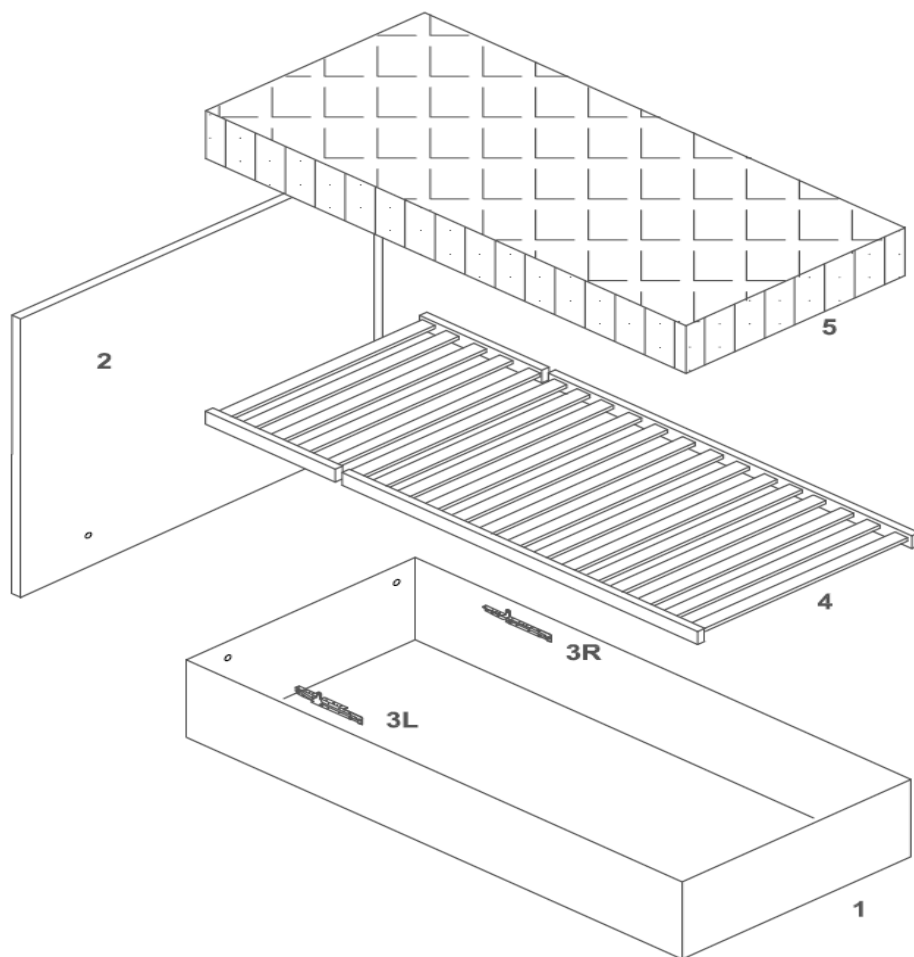

0
10
20
30
40
50
60
70
80
90
100
110
120
130
140
150
160
170
180
190
200

Service • Assistenza • Dienstverlening • Serwis Servis • Szerviz • Сервисная служба	
Name • Nom • Nome • Naam Nazwa • Jméno • Názov • Név Denumire • İsim • Название	Nebbio EB
Nr. • No. • N° • Номер • Č • Sz	SH46
Typ • Type • Tip • Típus • Tipo Тип	LARO

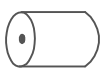

A	B	C	D	E	F	G	H
4x	4x 8x50	4x 10x80	4x 8x20	2x	2x 8x60	2x 8x40	2x M8



A	B	C	D
			
4x	4x 8x50	4x 10x80	4x 8x20

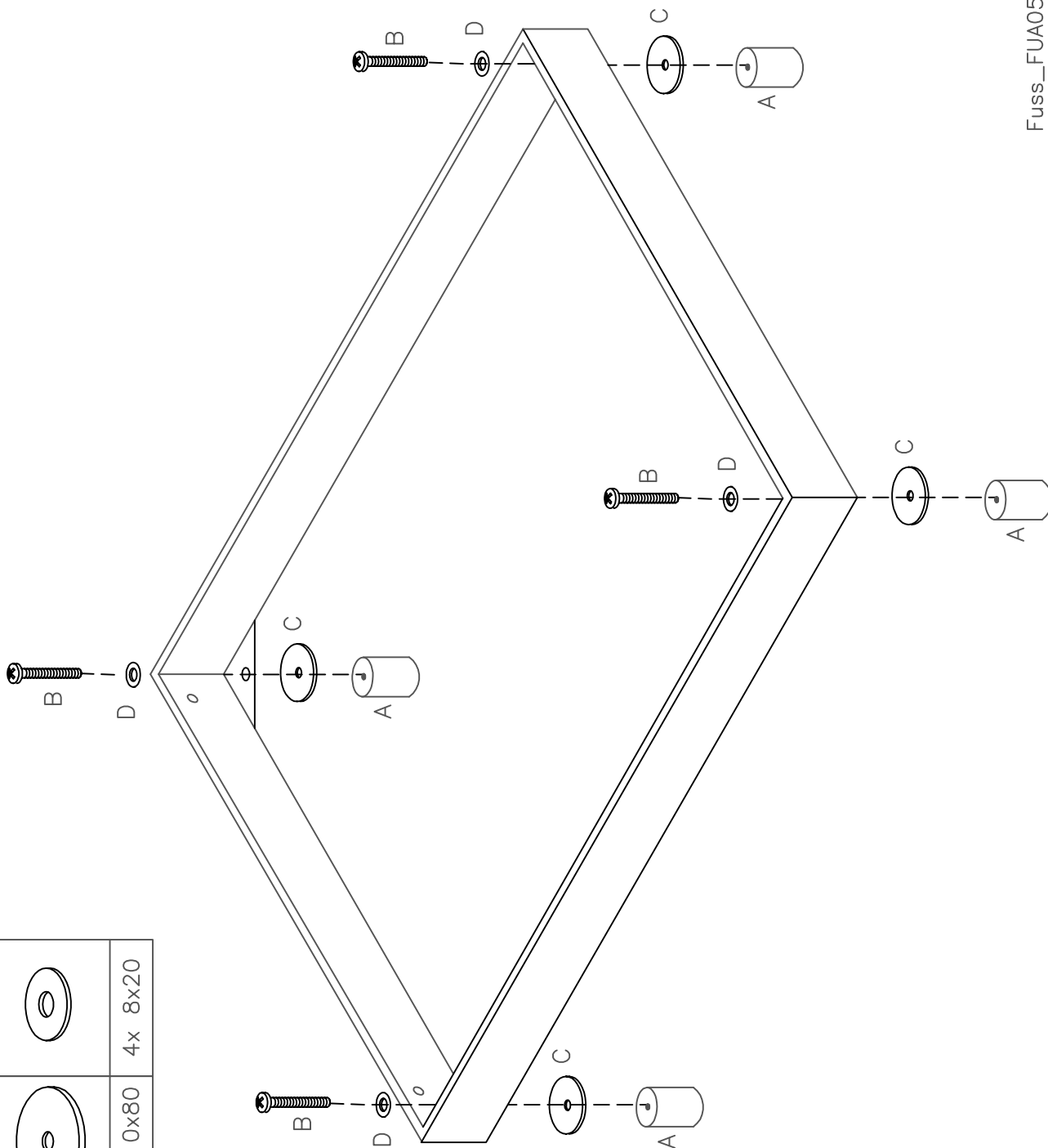

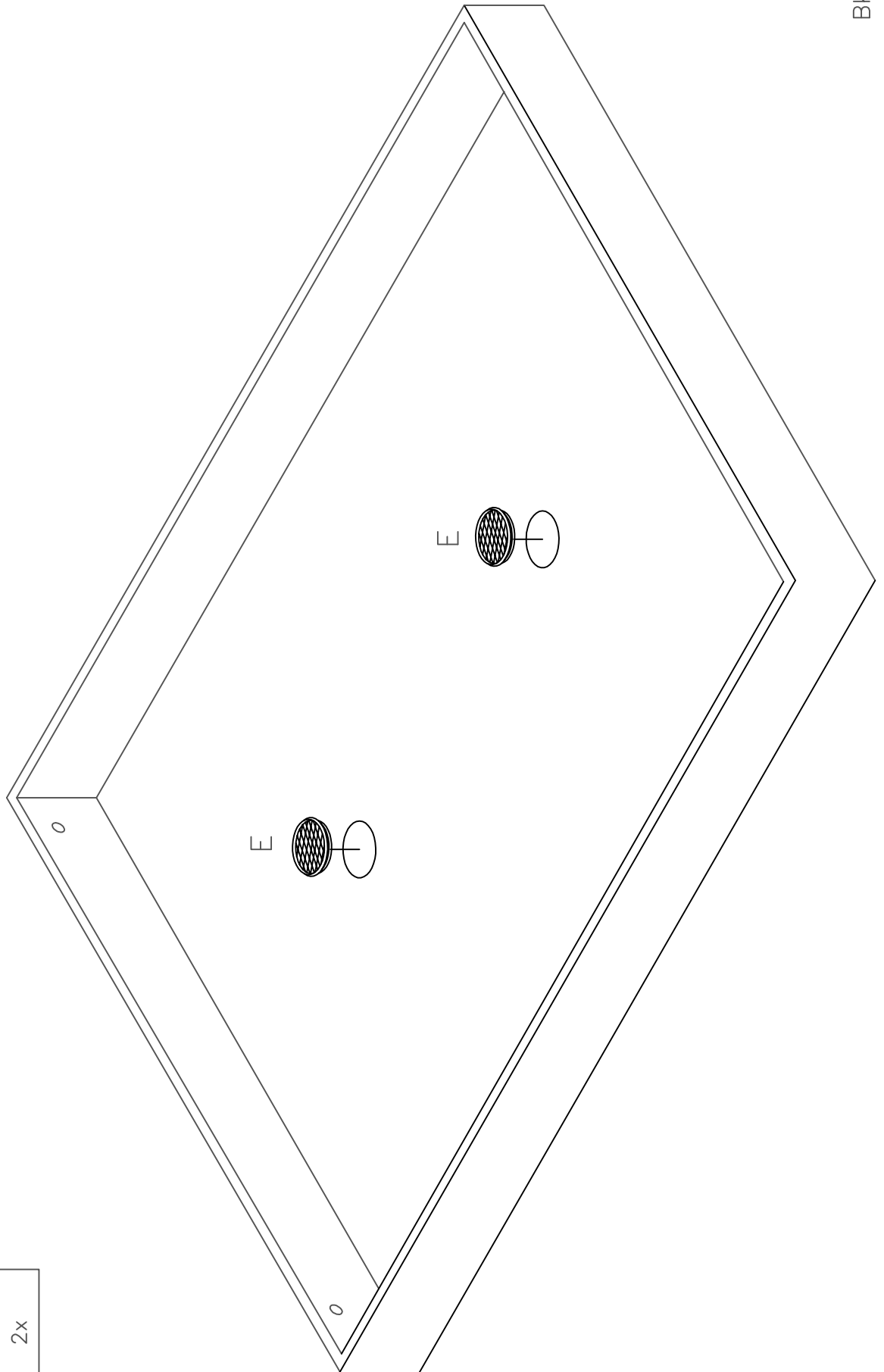

E		2x
---	--	----

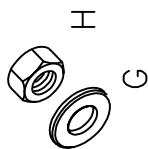

F		G		H		<p>Achtung! Schrauben nicht überdrehen FR Attention! Ne serrez pas trop CZ Dávej Pozor! Nepřetahujte RO Ai Grija! Nu strângeți PL Uwaga! Nie dokręcać zbyt mocno HU Vigyázz! Ne húzza túl</p> <p>GB Watch Out! Do not over tighten NL Let Op! Niet te vast IT Attento! Non stringere RU Осторожно! Не затягивайте SK Dávaj Pozor! Nepretahujte TR Dikkat! Üzerinde sıkmayın</p>
2x 8x60	2x 8x40	2x M8				

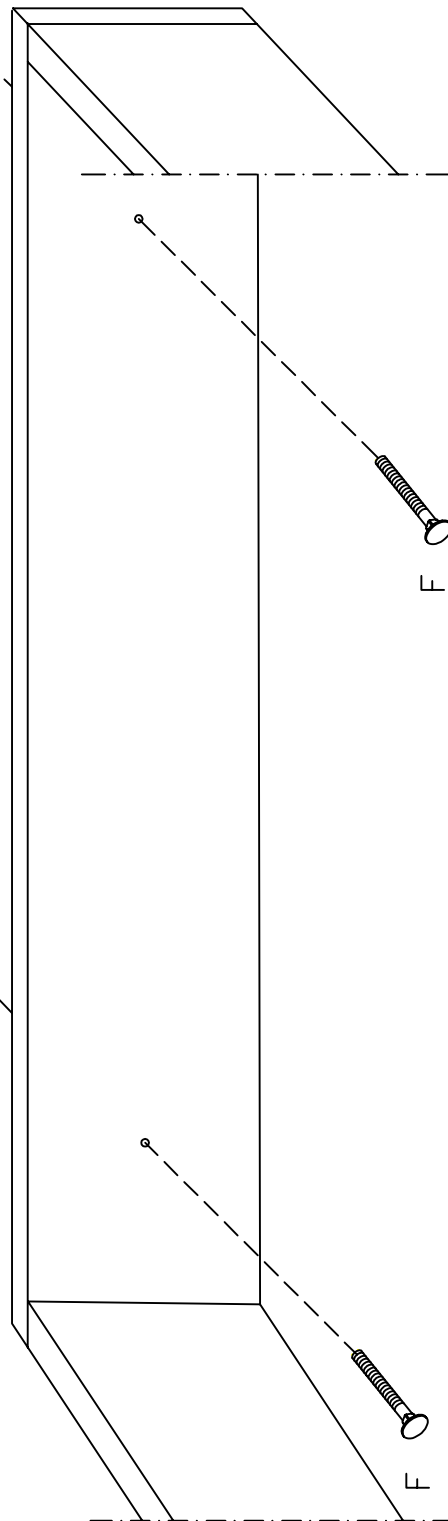
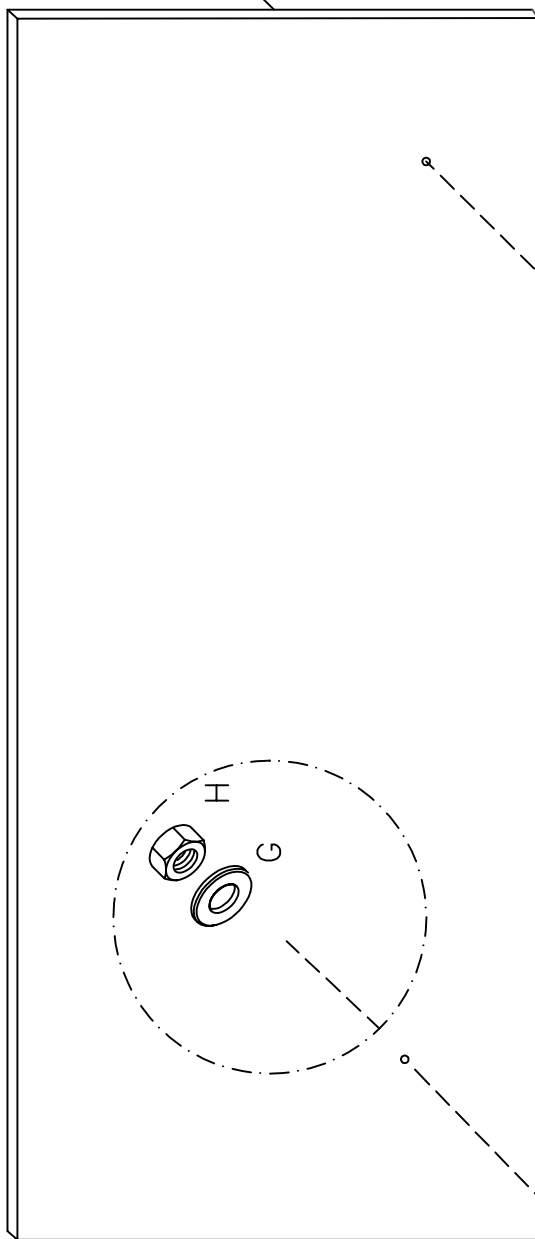

KT_2xSchloss_8x60