

# AHS 30 Variante

Montageanleitung / Notice de montage / Assembly instruction

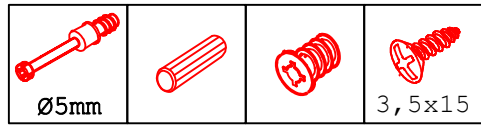

12x 34x 20x 10x



12x

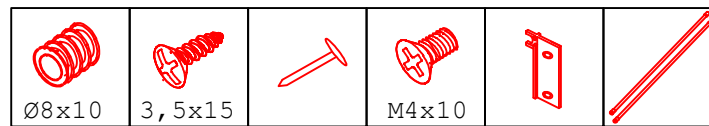

20x 56x 15x 20x 8x 4x

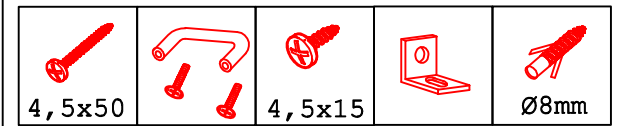
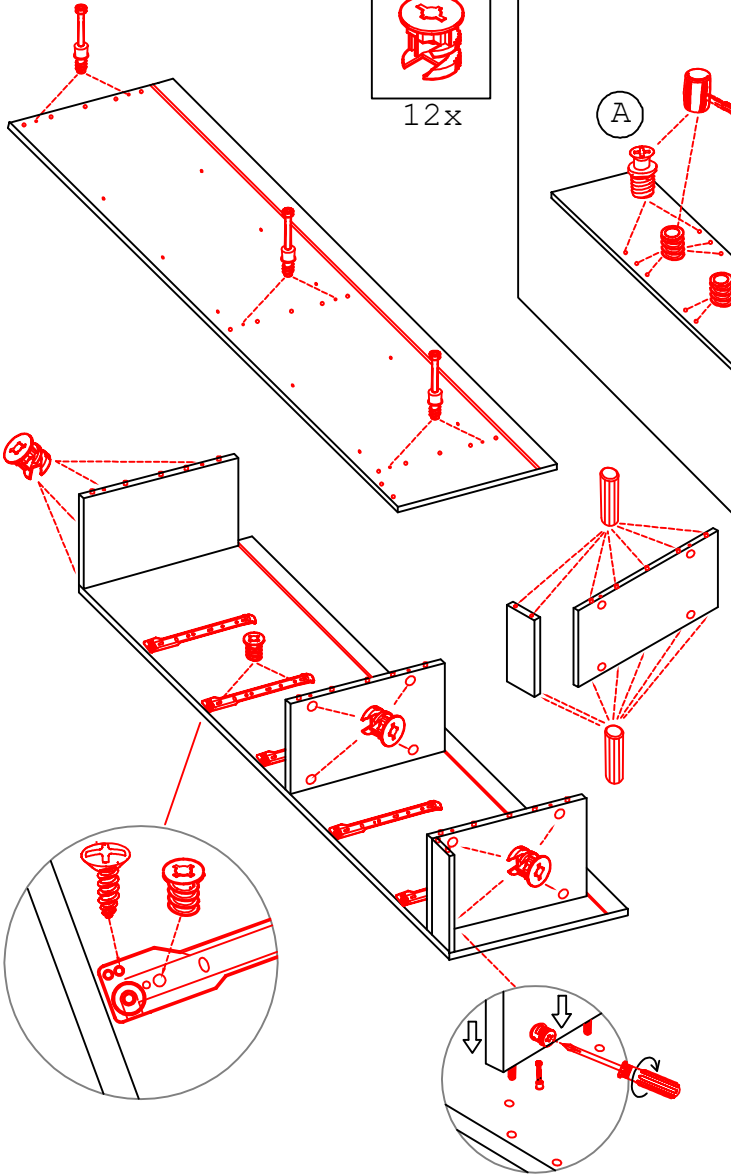
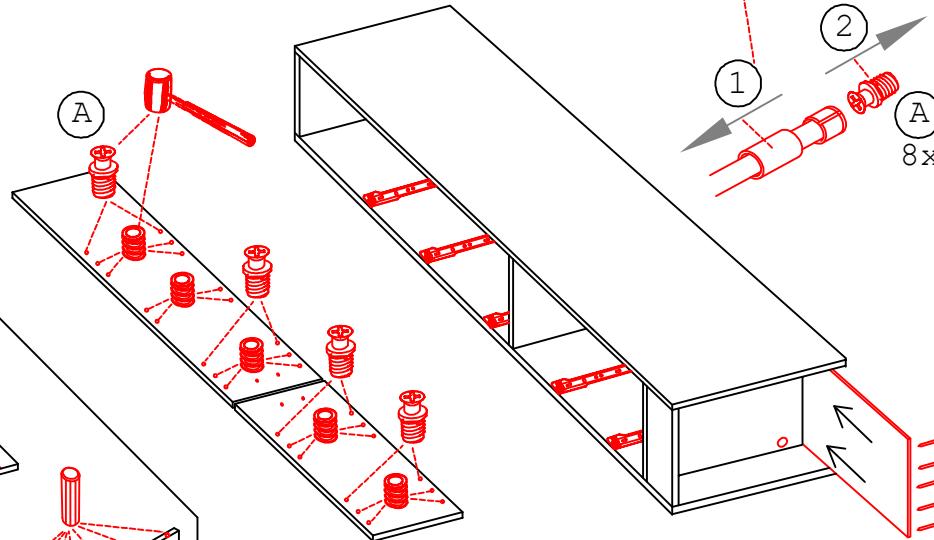

1x 2x 1x 1x 1x

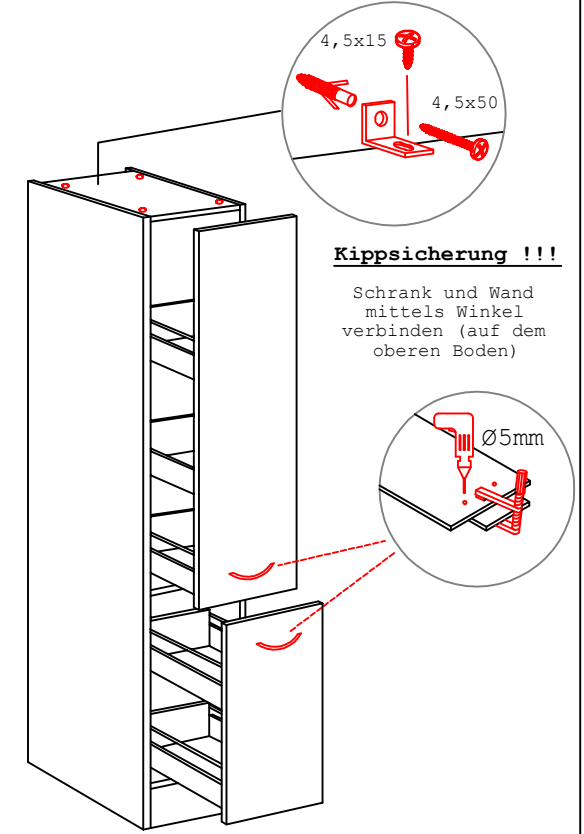

**Kippsicherung !!!**

Schrank und Wand mittels Winkel verbinden (auf dem oberen Boden)

Die Einstellung der Auszug-Blenden bitte durch drehen an den einzelnen Reihlingstangen vornehmen. (heranholen oder wegdrücken)

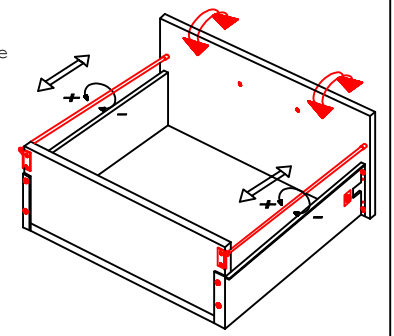

M4x10

# H 80 / H 100 / HG 100 / HGH 100

## Varianto

Montageanleitung / Notice de montage / Assembly instruction

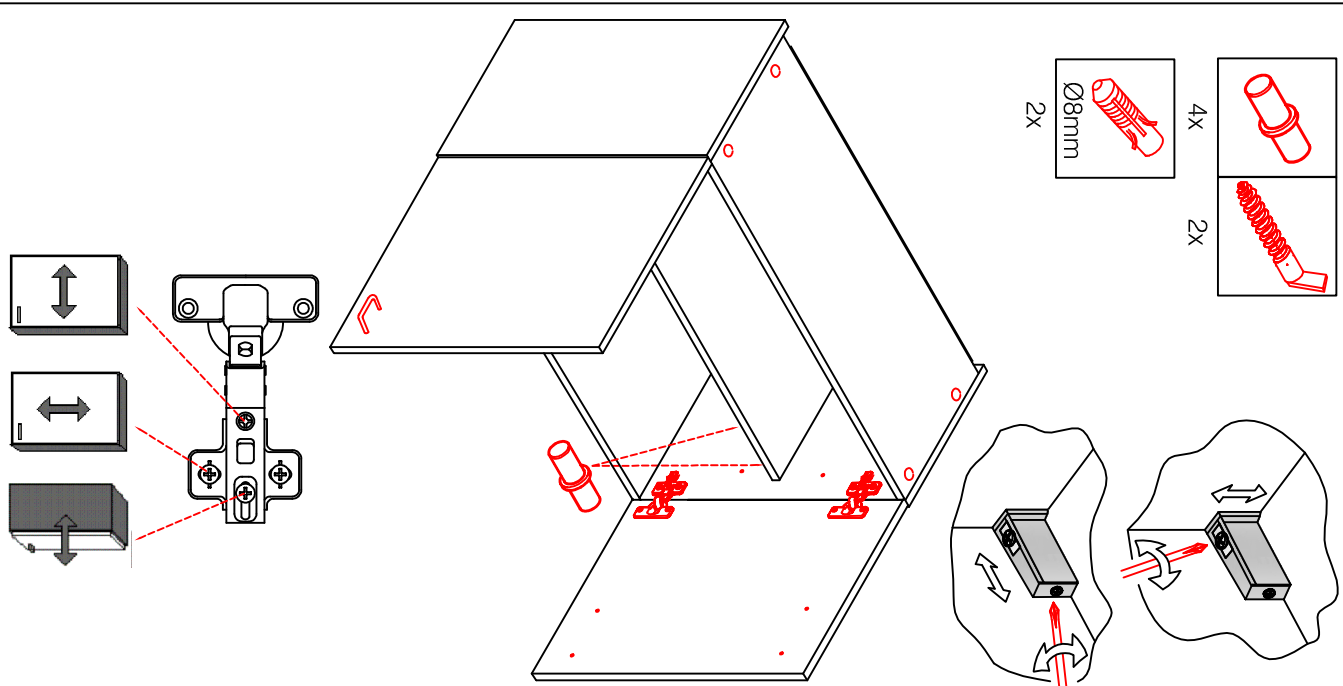
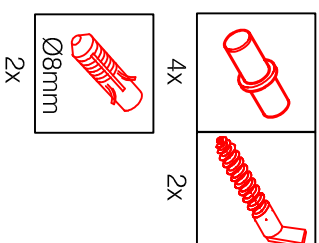
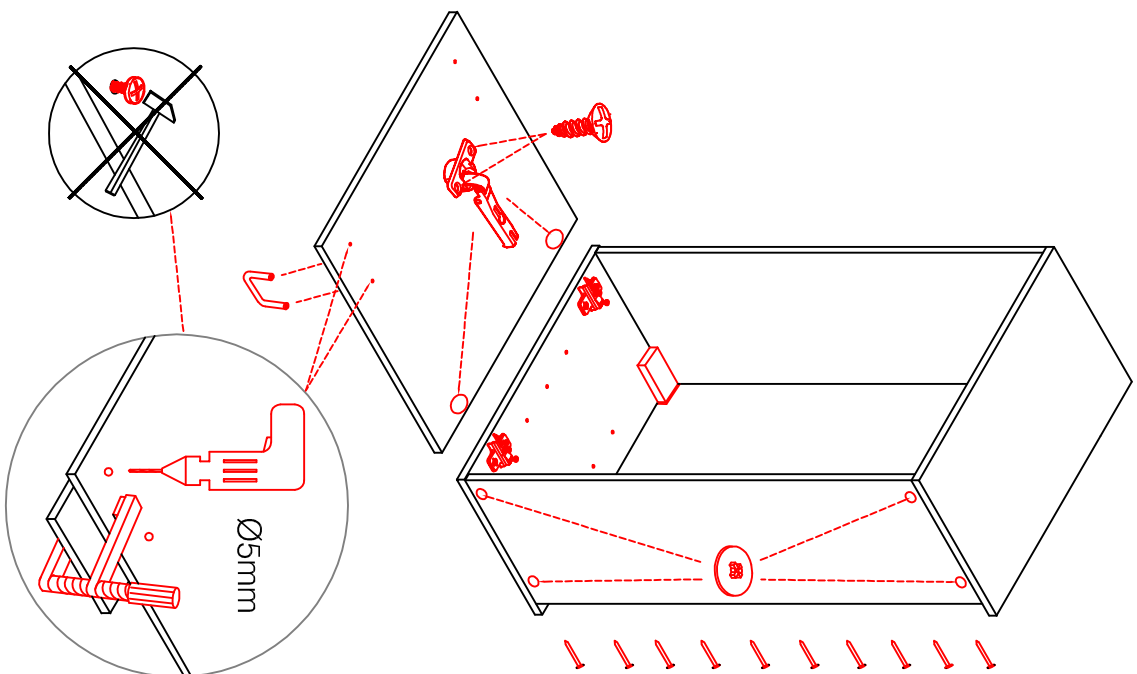
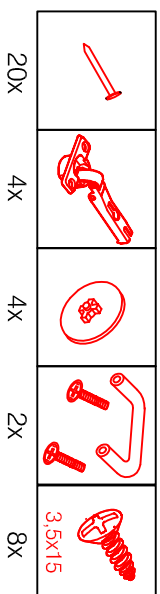
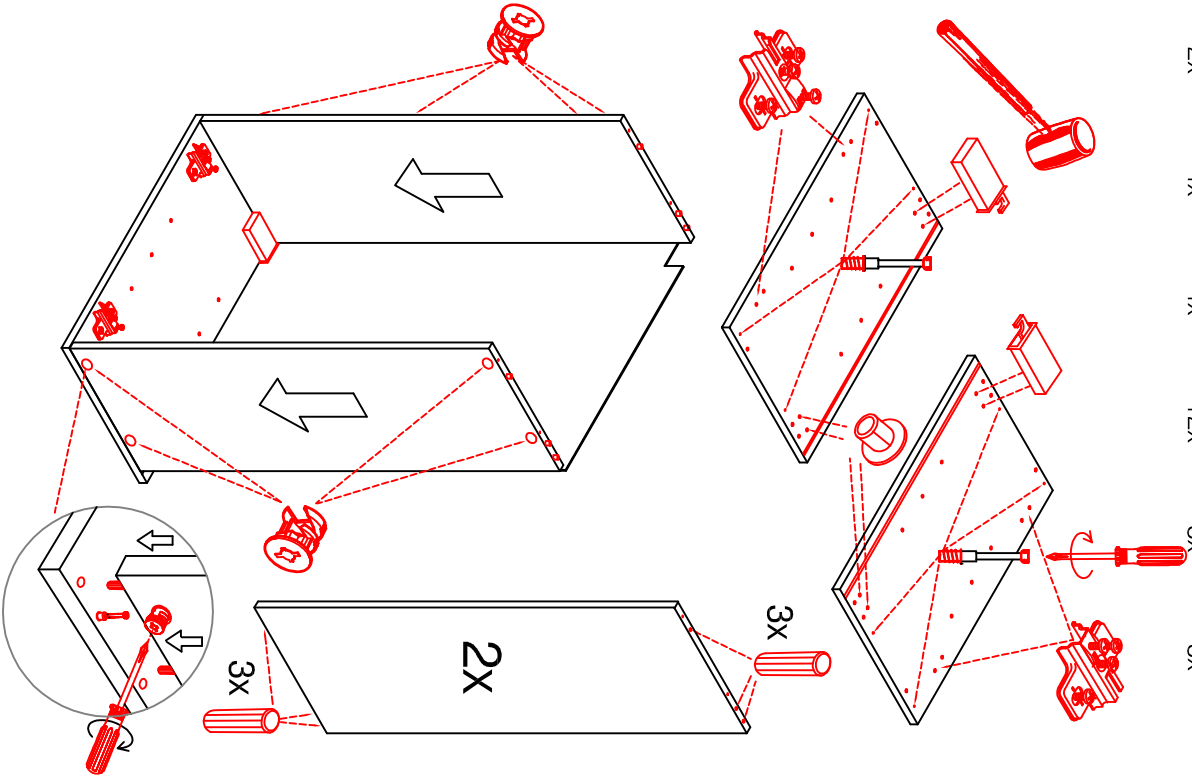
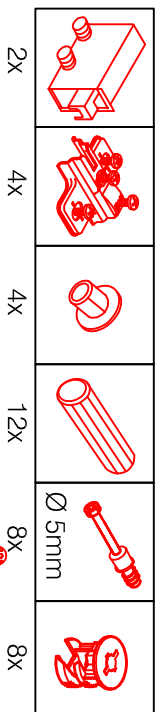

# SPU 50 Variante Blocktype

Montageanleitung / Notice de montage / Assembly instruction

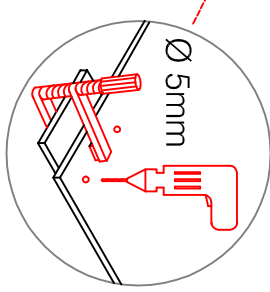
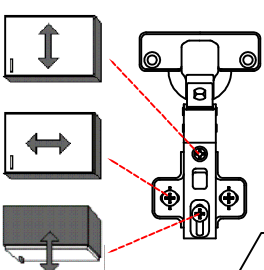
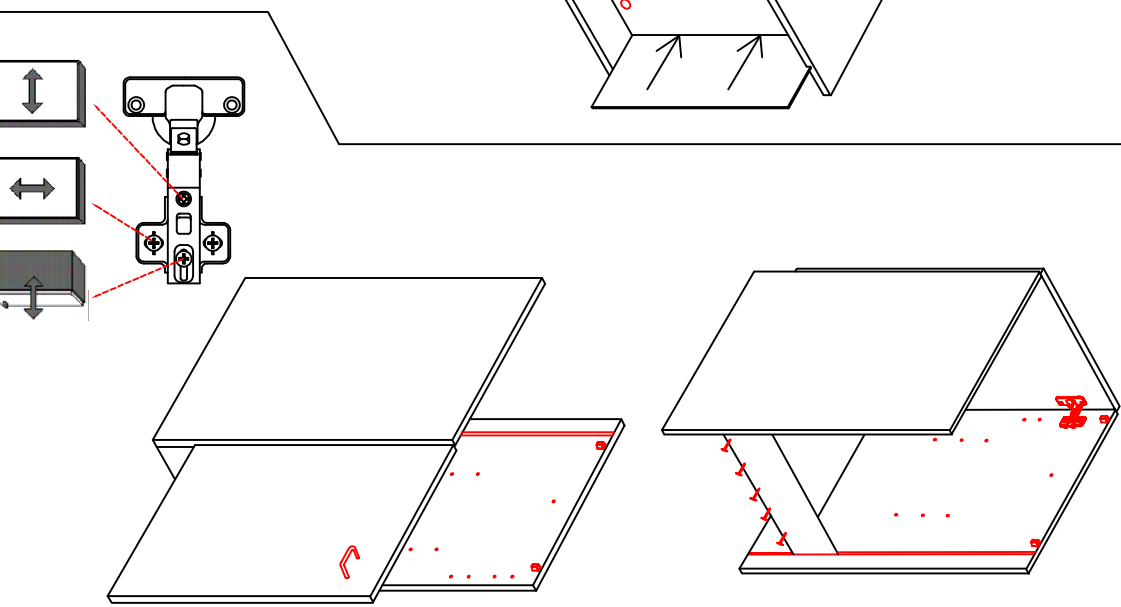
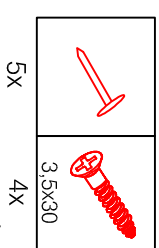
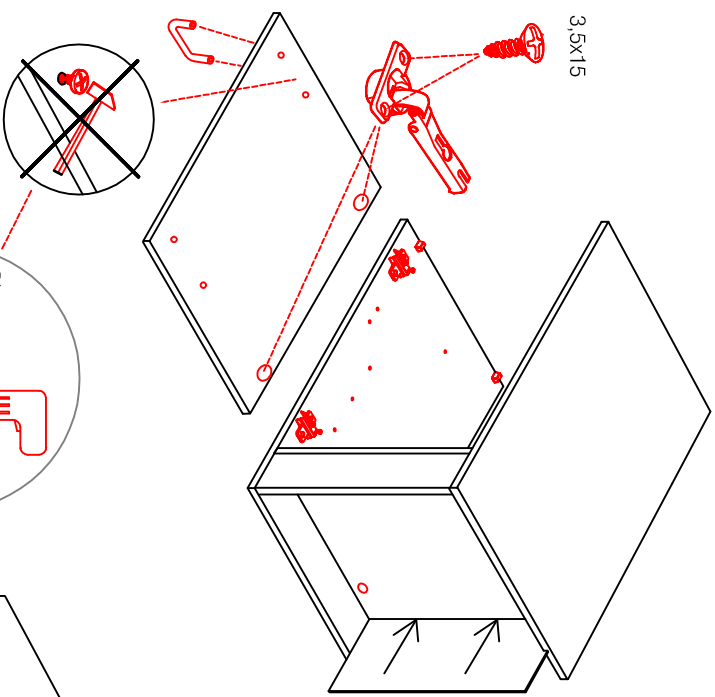
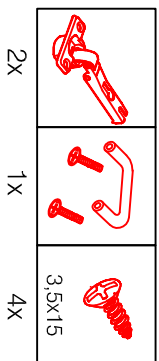
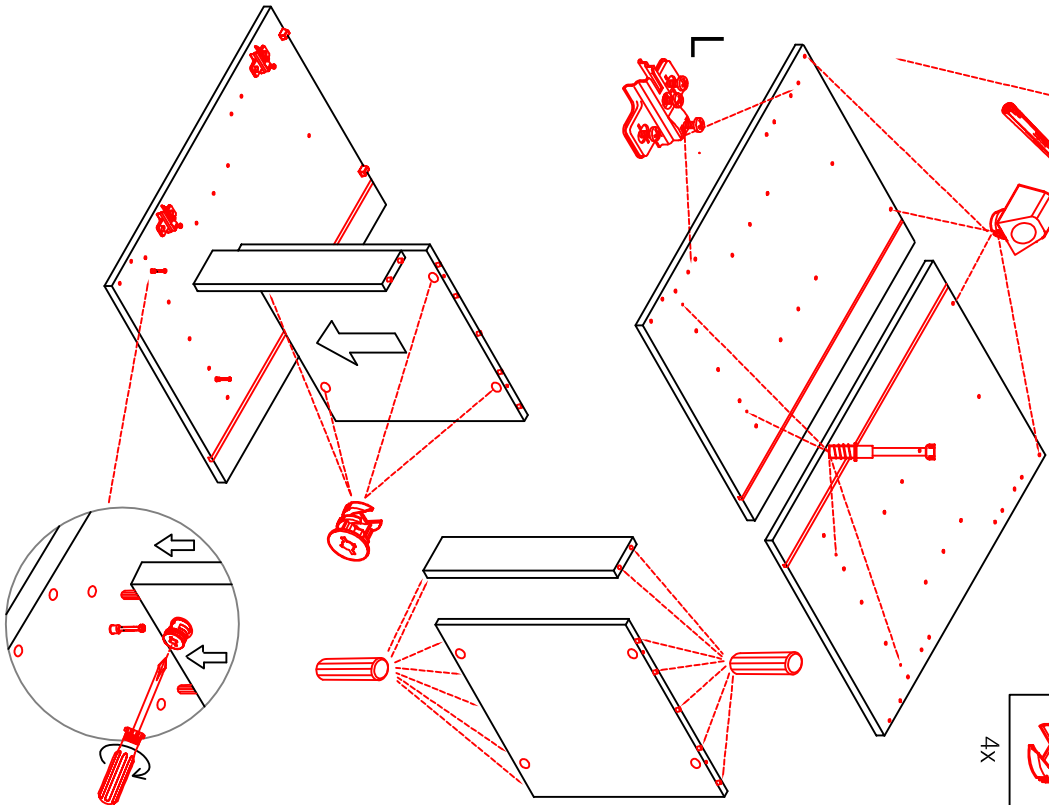
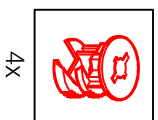
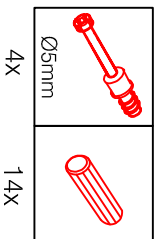
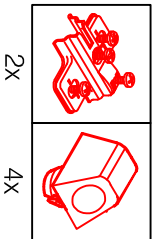
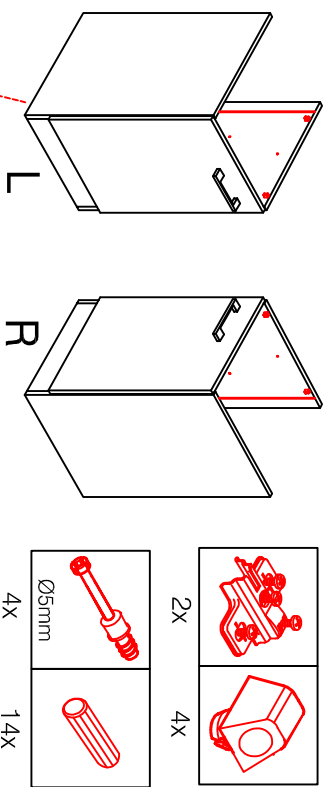

# USSA 50 B Variante

## Montageanleitung / Notice de montage / Assembly instruction

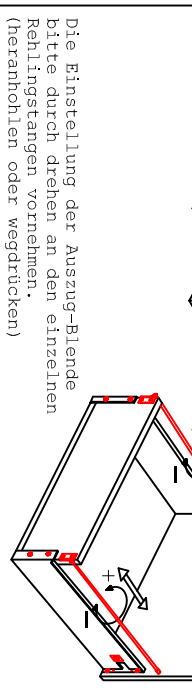
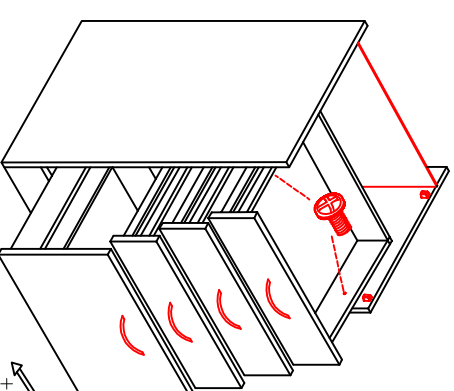
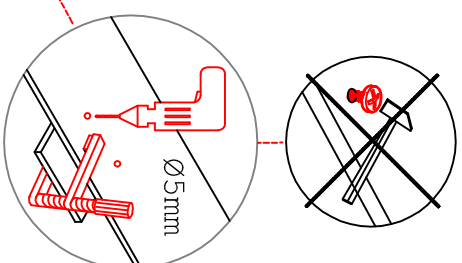
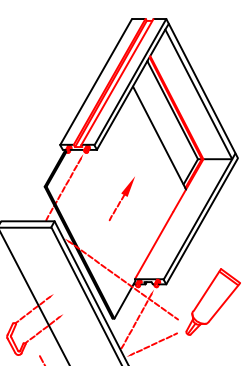
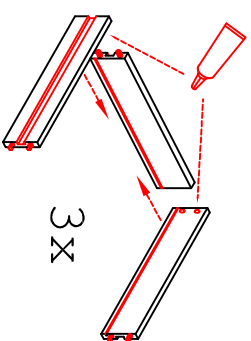
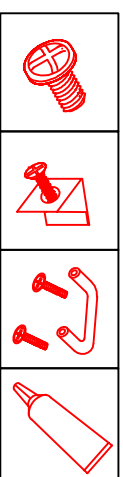
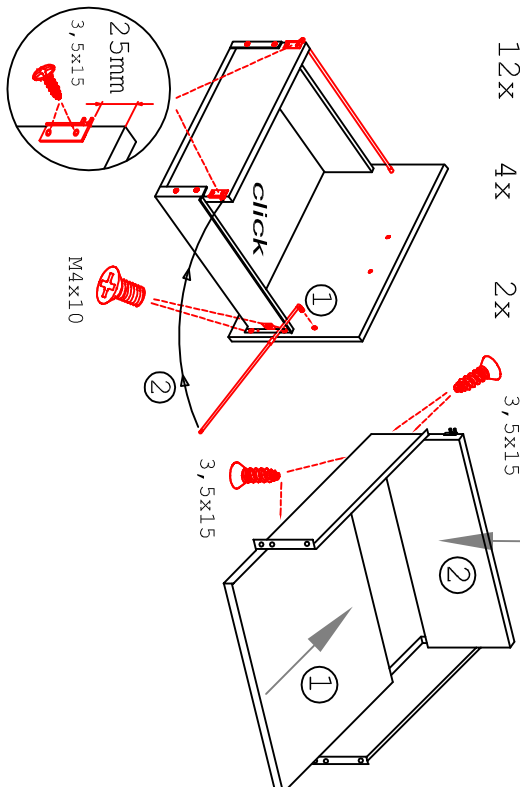
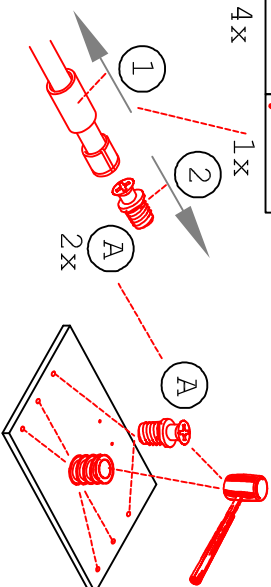
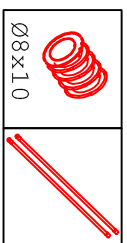
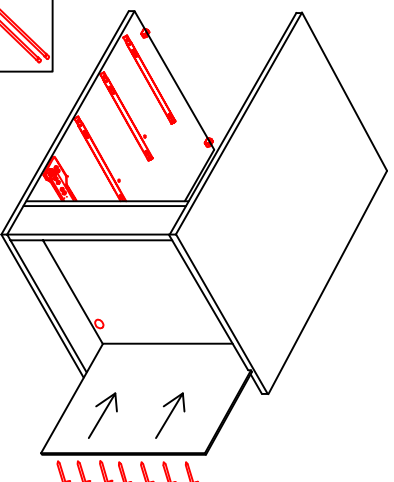
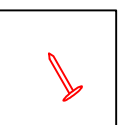
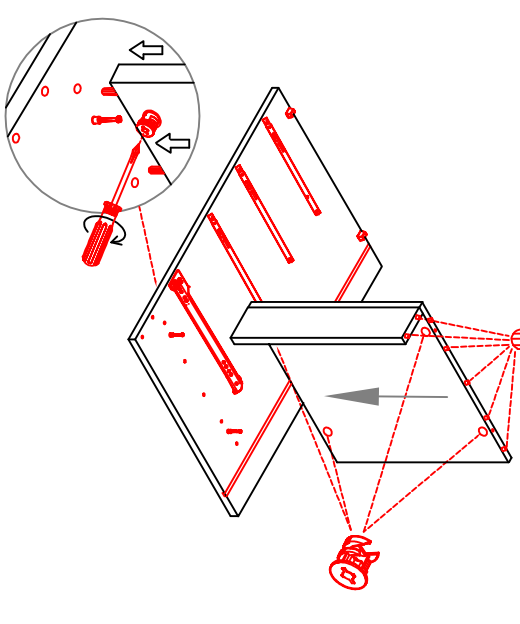
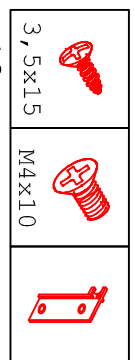
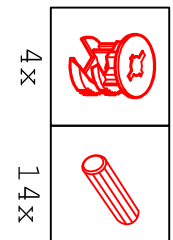
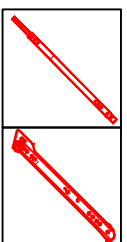
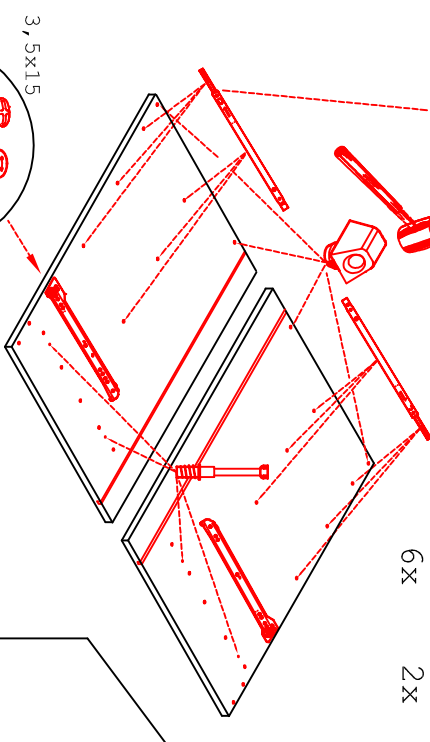
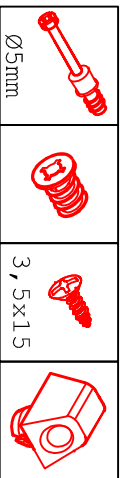
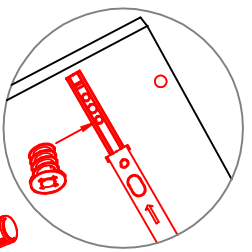

Die Einstellung der Auszug-Blende bitte durch drehen an den einzelnen Reihingstangen vornehmen. (heranhohlen oder wegdrücken)