

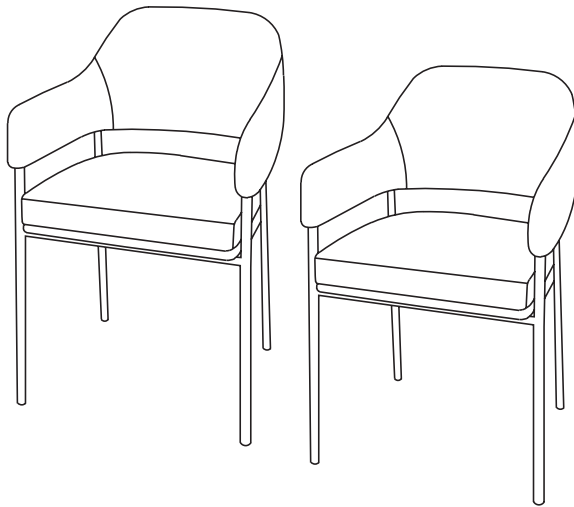

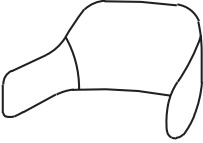







Montageanleitung
für
SCARLETT
2er Set Esszimmerstuhl



92191-92196

Nr.	Form	Anzahl je Stuhl
A		1
B		1
C		1
D		1
E		4 M6x16
F		6 M6x25
G		6
H		1

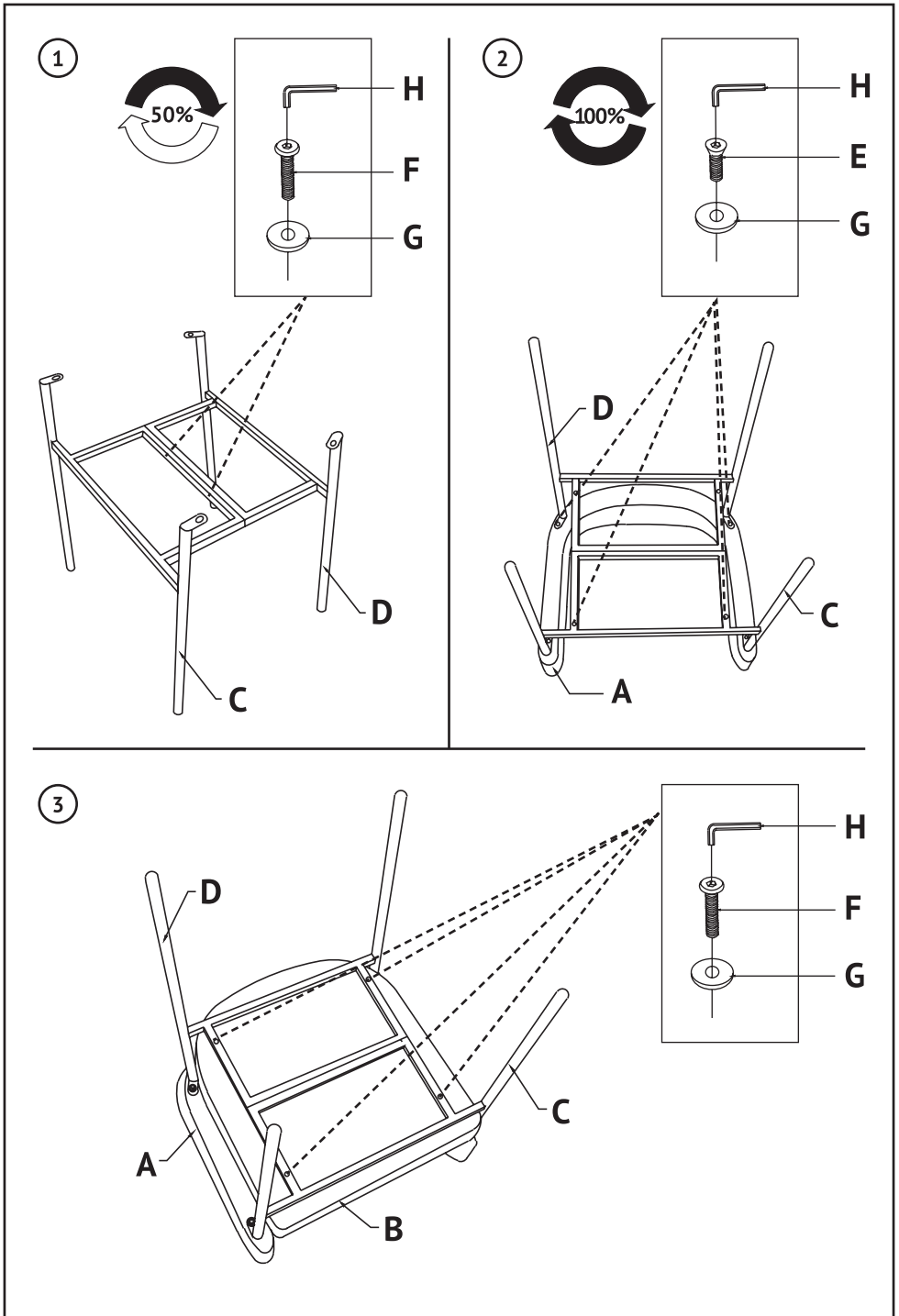



Vielen Dank für Ihren Einkauf!

**Falls Sie Unterstützung benötigen, können
Sie sich gerne an unser Service Team wenden:**

+49 2203 94 79 300
service@svita-shop.de
www.svita-shop.de

Clic-Trade GmbH
Stollwerckstr. 27-31
51149 Köln
www.clictrade.gmbh