

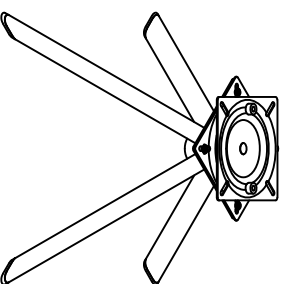

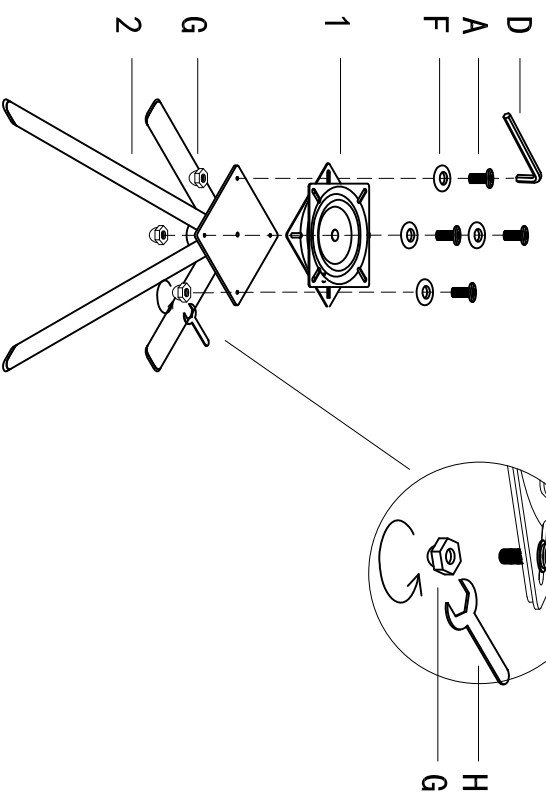







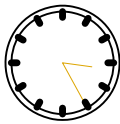

MCA

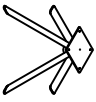
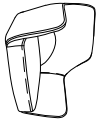
furniture

TONALA

STEP 1



			1		2	
3		A 	B 	C 		
D	1x	M6x14mm 4x	F 	G 		
H						
D		E 	M4 1x	M6 8x	M6 4x	
D	Bitte überprüfen Sie in regelmäßigen Abständen den festen Sitz der Schrauben!	NL	Controlleer op regelmatige afstanden of de schroeven goed vast zitten.			
GB	Please check the screws for tightness at regular intervals!	SWE	Kontrollera med jämna mellanrum att skruvarna sitter fast ordentligt!			
F	Veuillez contrôler régulièrement que les vis sont convenablement serrées !	SK	V pravidelných intervaloch kontrolujte pevné dotiahnutie skrutiek!			
ES	¡Compruebe periódicamente que los tornillos estén bien apretados!	SL	Redno preverjajte, ali so vijaki trdno priviti!			
IT	Controllare regolarmente che le viti siano ben strette!	NR	Redovito proverjavajte čvrsto najiganje vijakal!			
PL	Należy regularnie sprawdzać dokrećenie śrub!					

MCA

furniture

TONALA

STEP 2

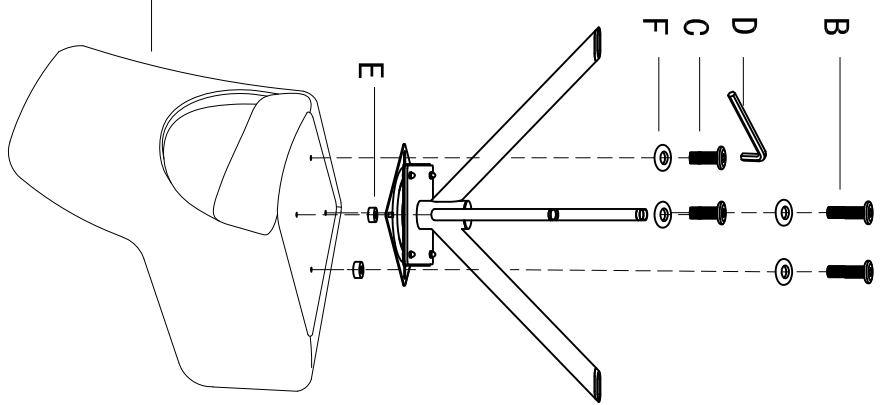

STEP 3

