

980757

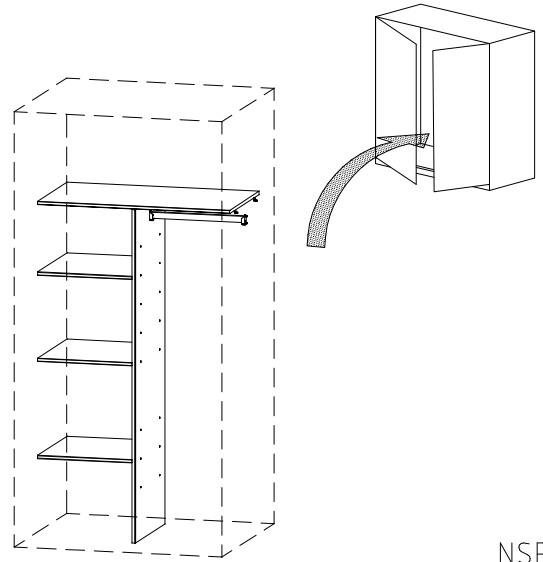

NSP 87

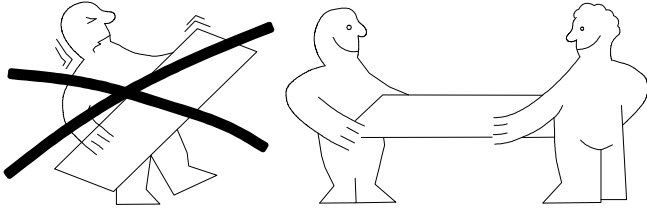
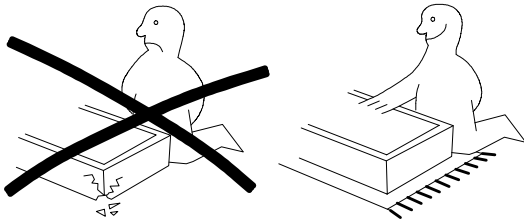
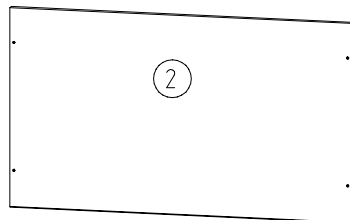
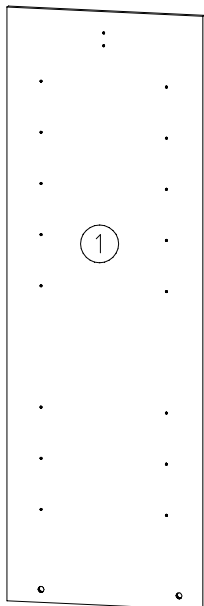
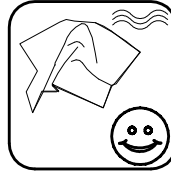
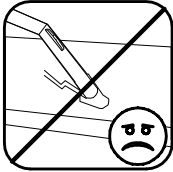
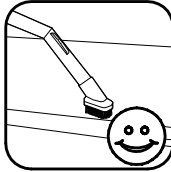
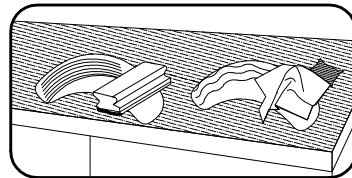
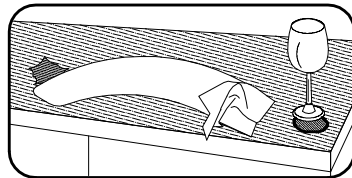
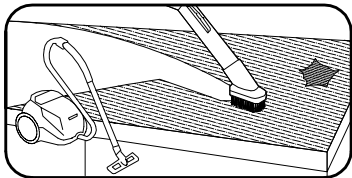
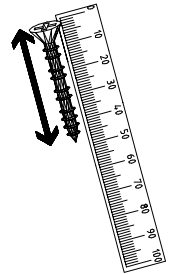
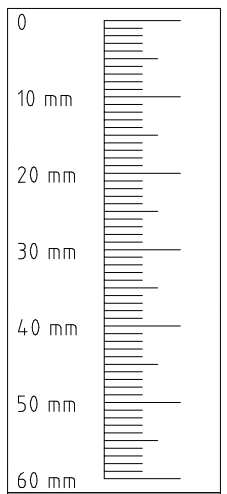
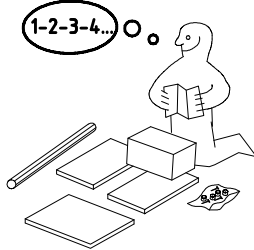
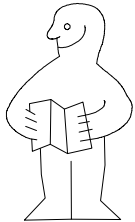

873 x 500 x 18

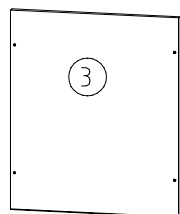

3x 429 x 500 x 18

1486x500x15

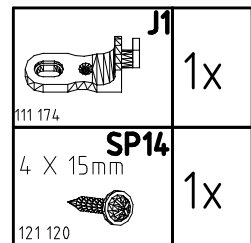
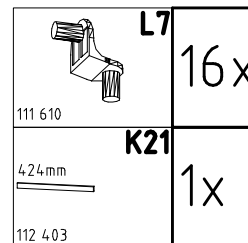
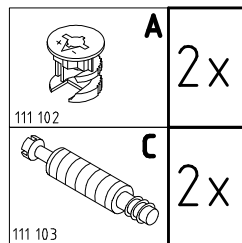
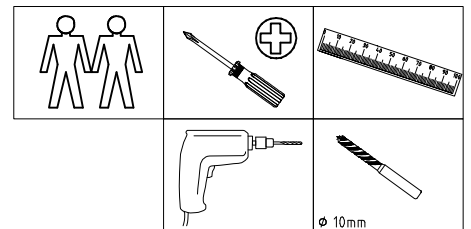

980757

17.06.11 / 09.09.13

09 13

1/4

1

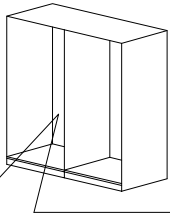

K20
870mm
112 402

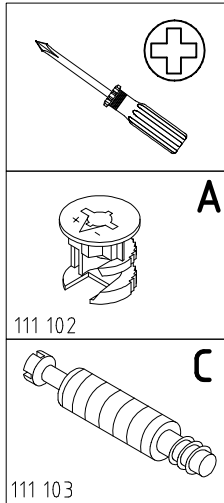
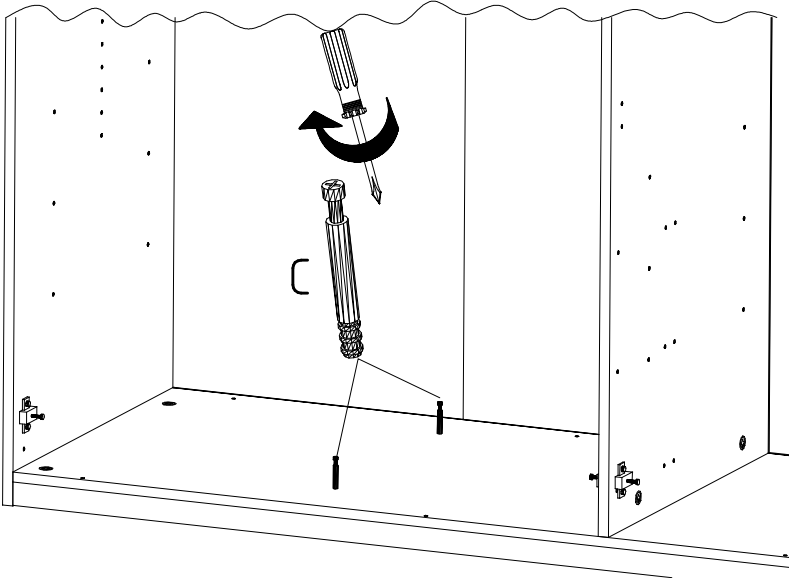
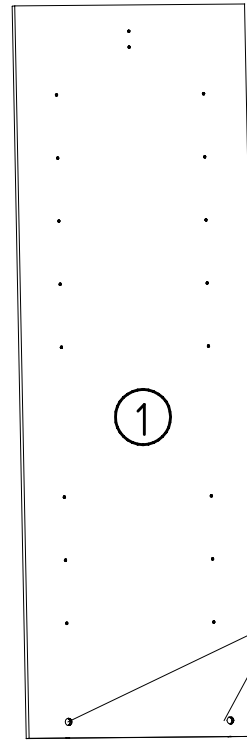
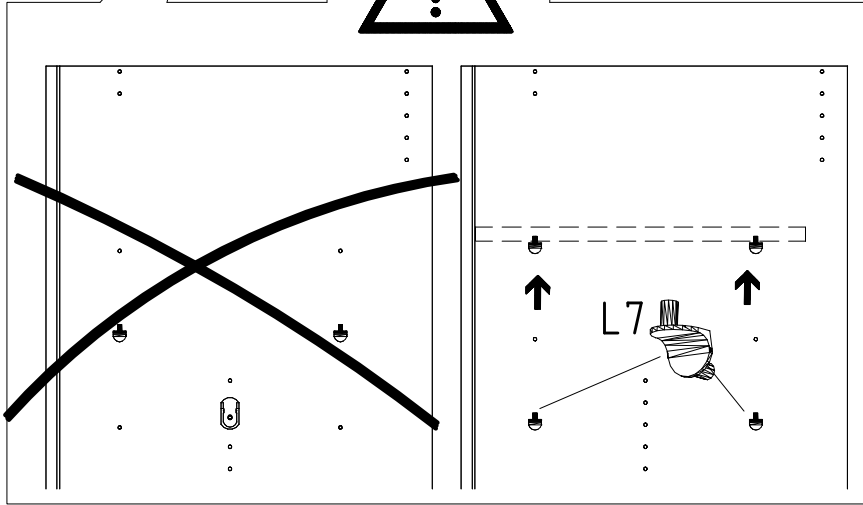
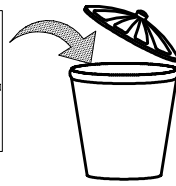

2

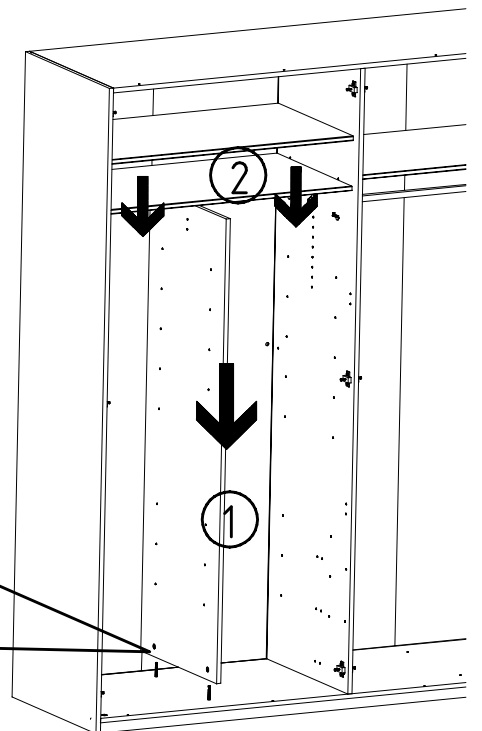
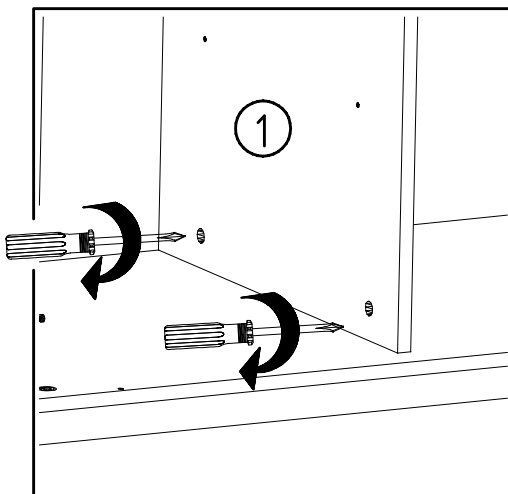
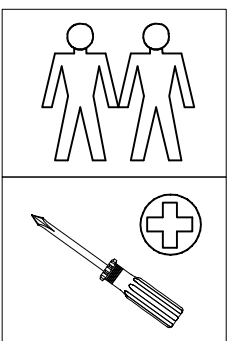

3

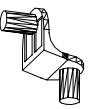
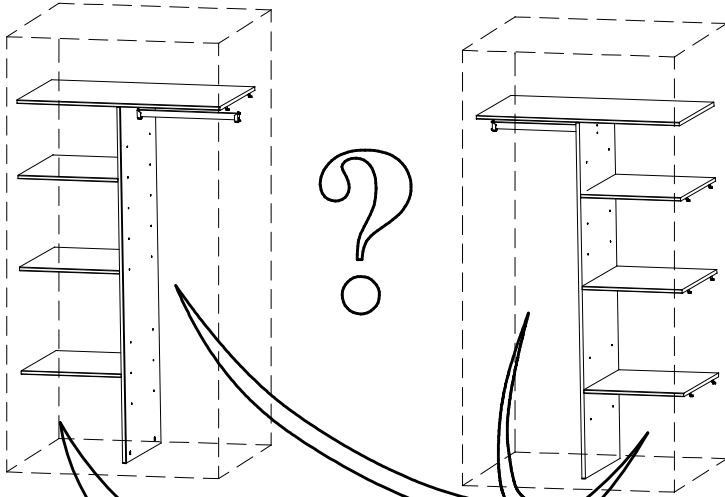

L7

111 610

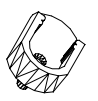
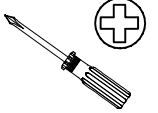

K1

117 001

3,5 x 15 mm

G1



121 370

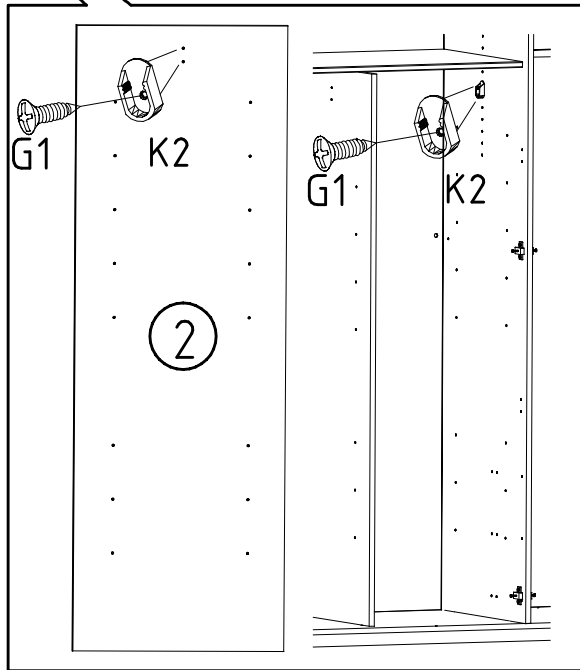
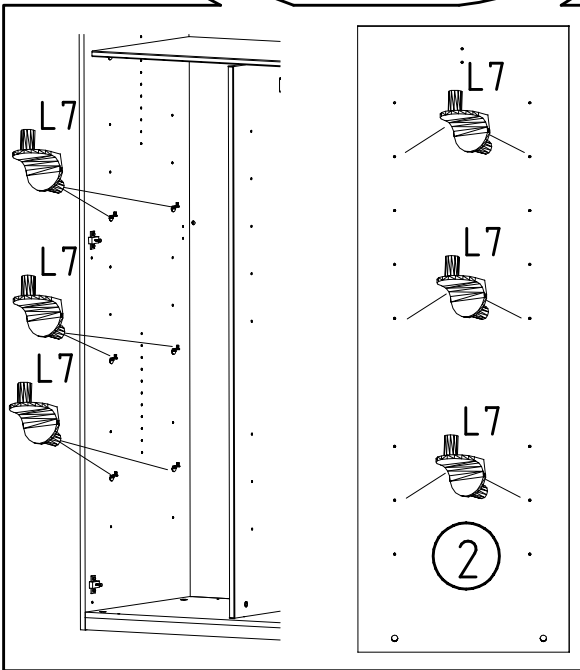

4

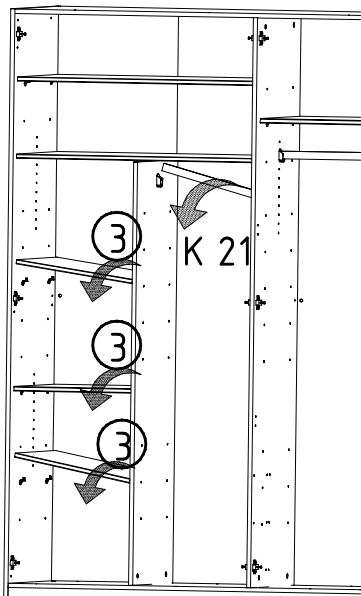
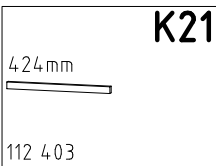

5

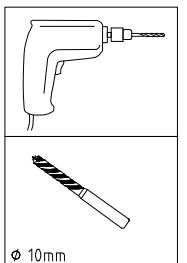
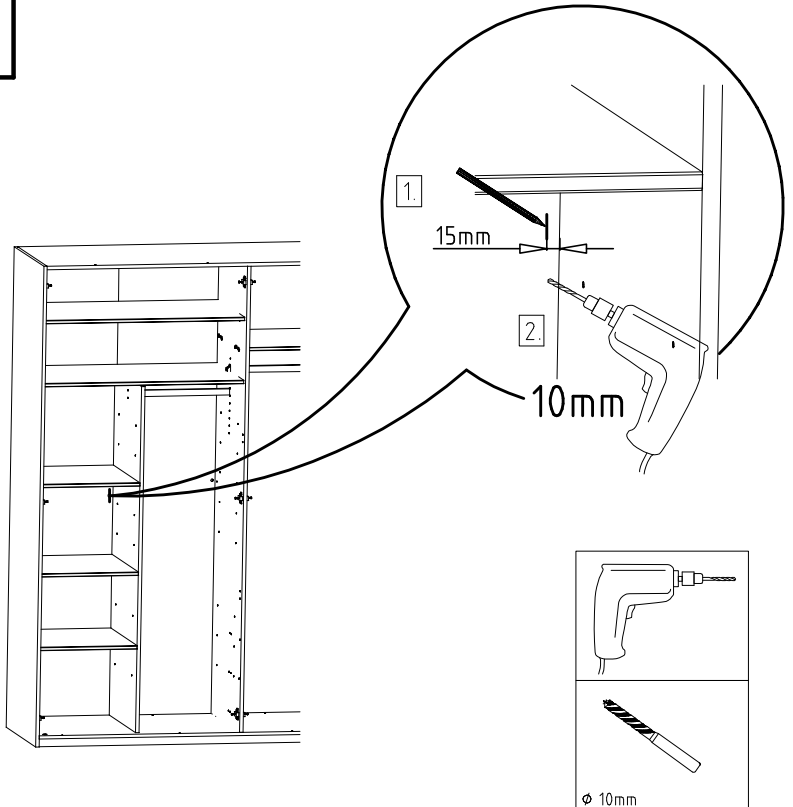

980757

17.06.11 / 09.09.13

09 13

3/4

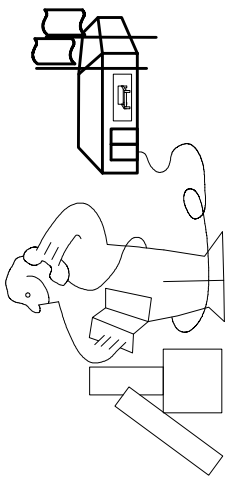
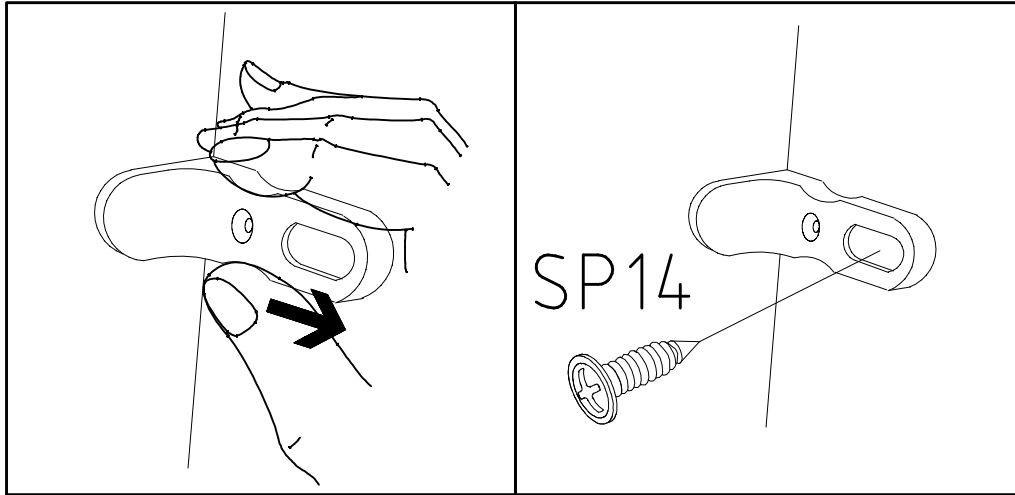
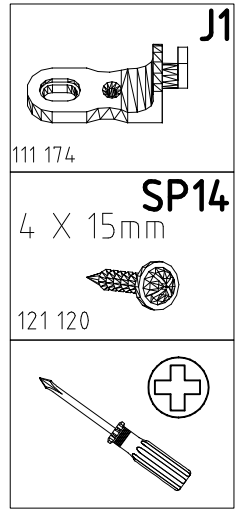
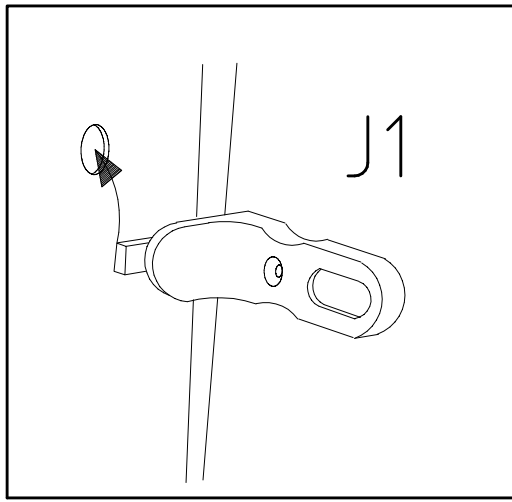

Modell/Model/Modèle

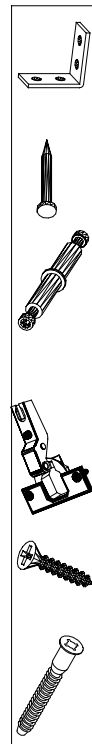
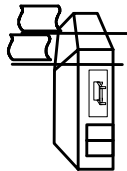
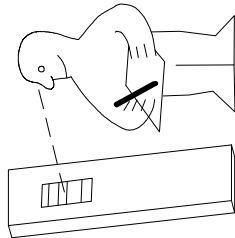

(121 370)	(G 1)	(4x)

Änderungen die dem technischen Fortschritt geschuldet sind, behalten wir uns vor!
Bei nicht vorschriftsmäßiger und/ oder nicht fachmännischer Montage wird bei Personen- und/ oder Sachschäden keinerlei Haftung übernommen.