EN: Assembly information
NL: Montageinformatie

DE: Montagehinweise
FR: Instructions de montage

DK: Samvejledning
ES: Información de ensamblaje

GLOW

TDL 313



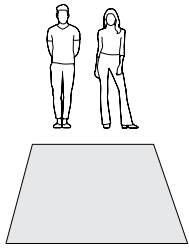

EN: Damages during assembly:

These can be avoided if you use a clean soft surface (e.g. carpet). Only place parts on a soft surface when unpacking or during the assembly. Make sure that larger parts can not tip over.

DE: Montageschäden:

Vermeiden Sie, indem Sie einen sauberen und weichen Untergrund verwenden (z.B. Teppich). Teile beim Auspacken oder während der Montage nur auf weiche Unterlagen legen/stellen. Darauf achten, dass grössere Teile nicht kippen können.

DK: Skader under montering:

Disse kan undgå, hvis du bruger en ren og blød overflade (fx et tæppe). Placer delene på en blød overflade ved udpakning og montering. Sørg for, at større dele ikke kan vælte.

NL: Beschadigenen tijdens montage:

Deze kunnen vermeden worden wanneer u een proper zacht oppervlak (bv. tapijt) gebruikt. Plaats enkel onderdelen op een zacht oppervlak bij het uitpakken of tijdens de montage. Zorg ervoor dat grotere onderdelen niet kunnen omkantelen.

FR: Dommages lors du montage:

Évitez les dommages en utilisant un fond propre et doux (p.ex. tapis). Lors du déballage et montage, posez les éléments uniquement sur un fond doux. Assurez-vous que les grands éléments ne peuvent pas basculer.

ES: Daños durante el ensamblaje:

Se pueden evitar si utiliza una superficie limpia y suave (p. ej., una alfombra). Únicamente ubique las piezas en la superficie suave cuando esté desempacándolas o durante el ensamblaje. Asegúrese de que las partes más grandes no se puedan dar vuelta.

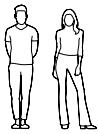

EN: People:

Two people are required for the assembly.

DE: Personen:

Für die Montage erforderliche Anzahl Personen.

DK: Personer:

Til montering skal der bruges to personer.

NL: Personen:

Aantal personen vereist voor de montage.

FR: Personnes:

Nombre de personnes nécessaires au montage.

ES: Personas:

Cantidad de personas necesarias para el ensamblaje.

EN: Tools required:

NL: Benodigde gereedschappen:





DE: Benötigtes Werkzeug:

FR: Outils nécessaires:

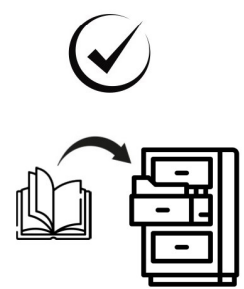
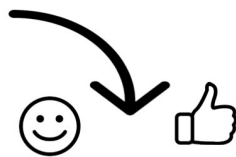
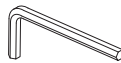
DK: Nødvendige værktøjer:

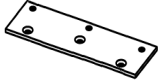
ES: Herramientas necesarias:



	A	B	C	D	E
					 L5key
2 seater / 2.5 seater 3 seater / pouf / corner	2	2	6	6	2
Open end	1	1	3	3	1
Chaiselong	3	3	9	9	3
2 seater without armrests	-	-	-	-	-
2 seater / 3 seater with one armrest	1	1	3	3	1

STEP 1

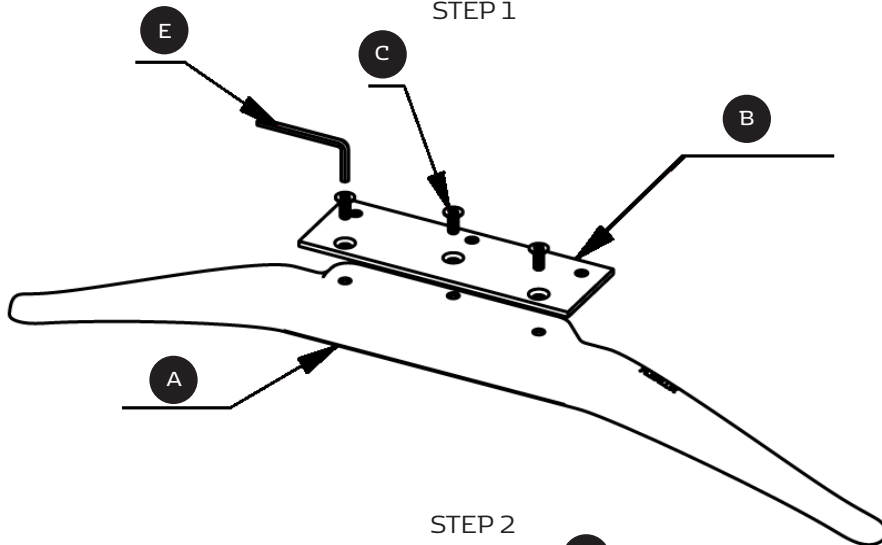

STEP 2

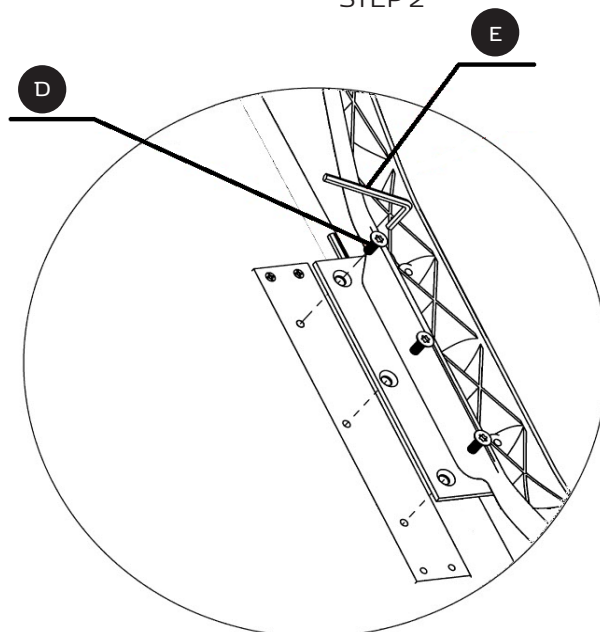

EN: Where to position the legs depends on configuration.

DK: Placering af benene afhænger af konfiguration.

FR: Position des pieds en fonction de la configuration.

DE: Position der Beine, abhängig von der Konfiguration.

NL: Waar de poten te plaatsen is afhankelijk van de configuratie.

ES: Dónde ubicar las patas según la configuración.

Open end + corner + 2 seater /
open end + corner + 2.5 seater /
open end + corner + 3 seater

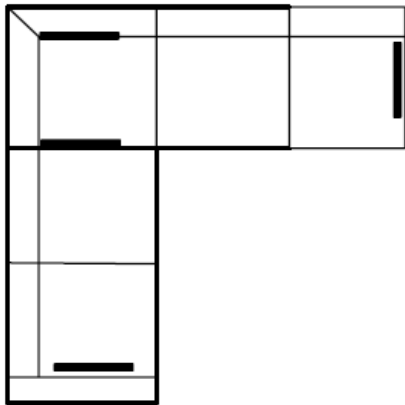

Chaiselong + 2 seater /
chaiselong+2,5 seater /
chaiselong + 3 seater

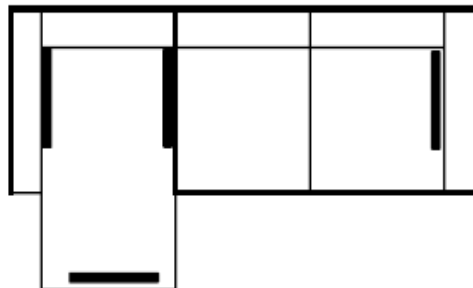

Open end + corner + 2 seater + chaiselong

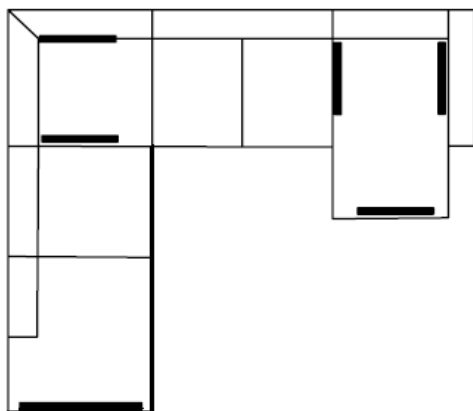

2 x 2 seater + corner + chaiselong

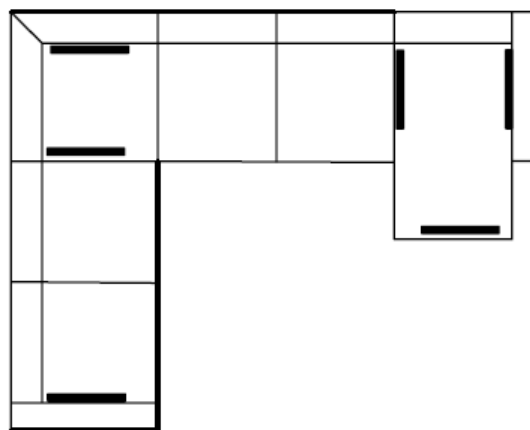

2 seater + corner + 3 seater

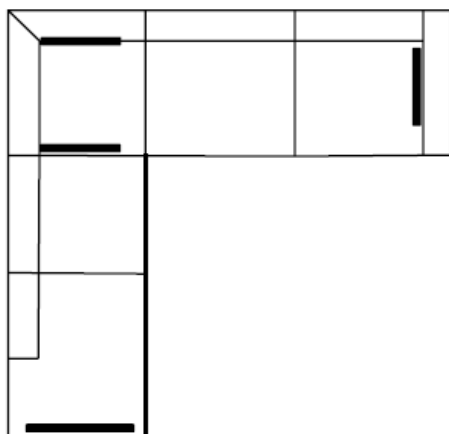

2 seater / 2,5 seater / 3 seater

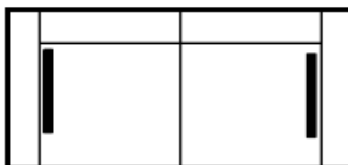

Pouf





EN: How to connect the modules.
NL: Hoe de modules verbinden.

DE: Verbinden der Module.
FR: Pour raccorder les modules.

DK: Samling af modulerne.
ES: Cómo conectar los módulos.

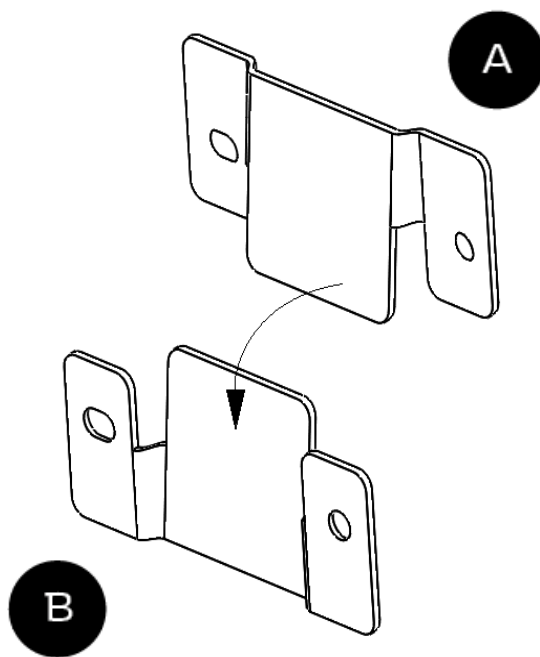
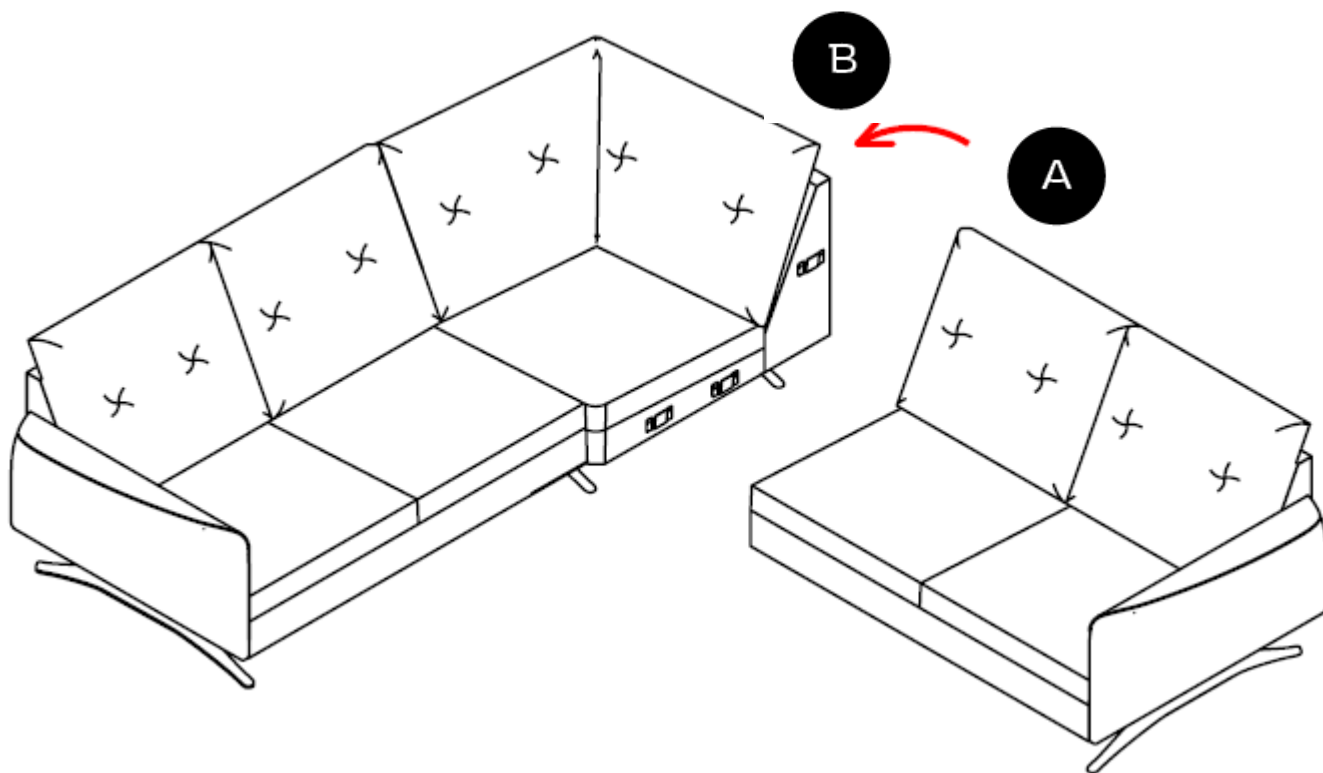

FR

Pensez à donner ou recycler.

 OU  OU 

ASSOCIATION LIVRAISON DÉCHÈTERIE

<https://quefairedemesdechets.fr>

quefairedemesdechets.fr