

# REGAL

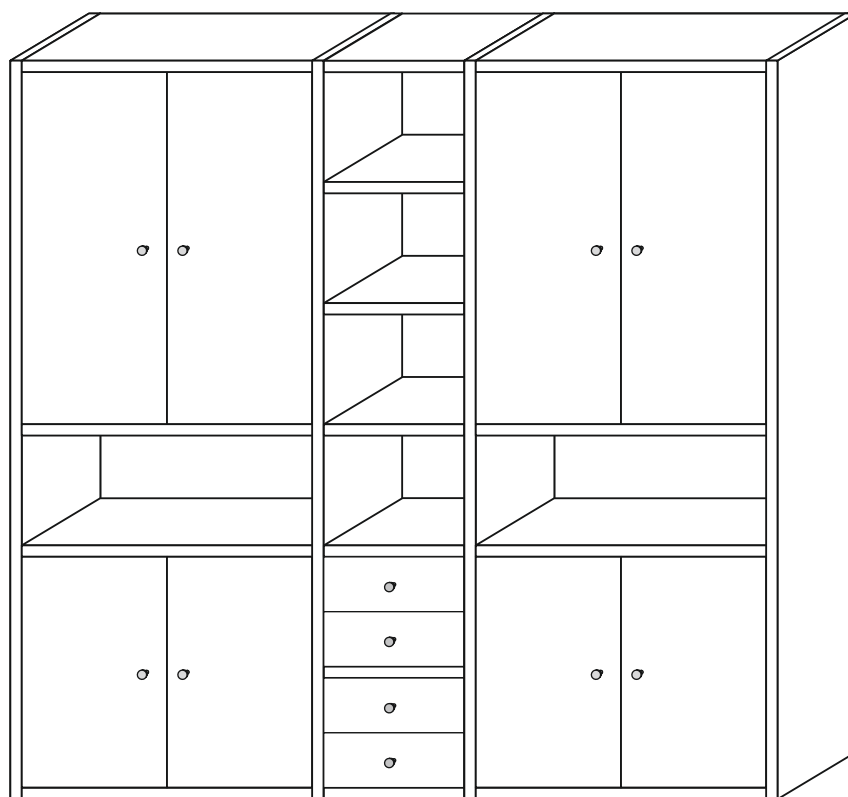

- |   |                                     |
|---|-------------------------------------|
| <b>(D)</b> Montageanleitung             | <b>(GB)</b> Assembly instructions   |
| <b>(FR)</b> Notice de montage           | <b>(IT)</b> Istruzioni di montaggio |
| <b>(NL)</b> Handleiding voor de montage | <b>(PL)</b> Instrukcja montażu      |
| <b>(CZ)</b> Montážní návod              | <b>(SK)</b> Návod na montáž         |
| <b>(HU)</b> Szerelési útmutató          | <b>(RO)</b> Instrucțiuni de montare |
| <b>(TR)</b> Montaj talimati             | <b>(RU)</b> инструкции по монтажу   |

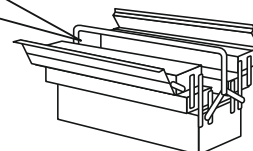

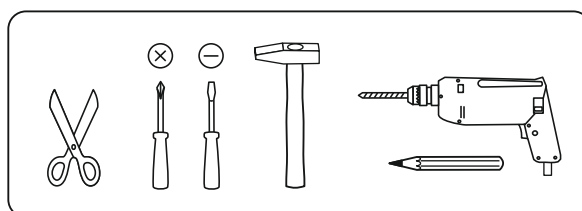
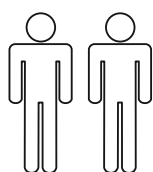
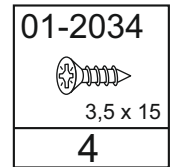
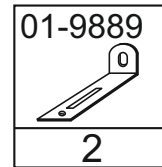
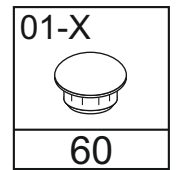
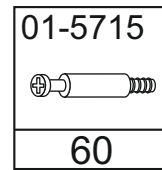
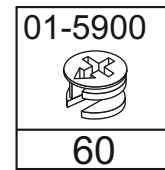
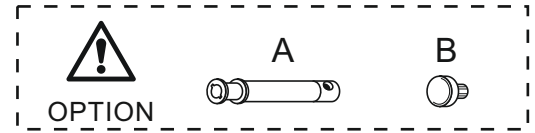
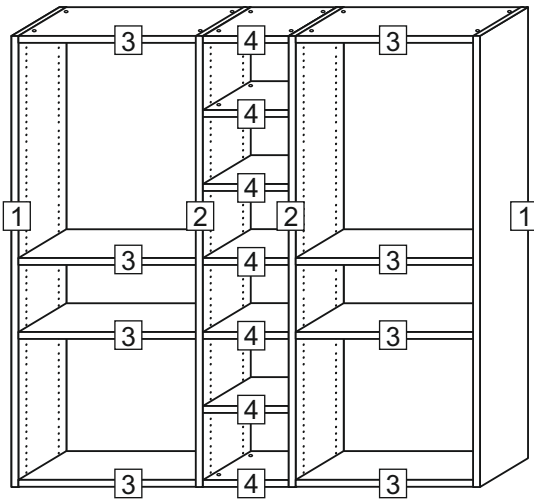
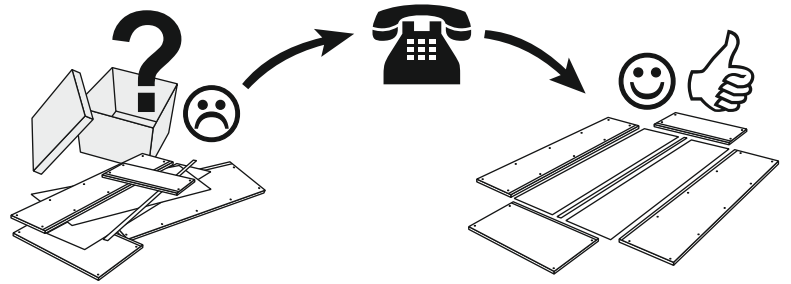
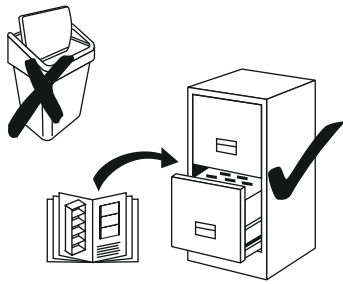

2x

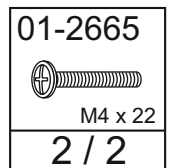
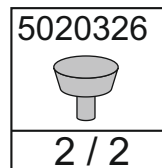
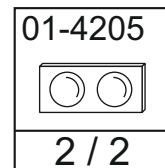
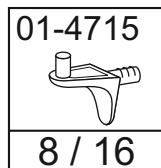
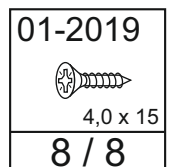
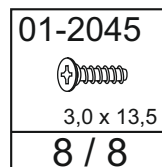
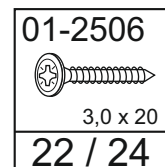
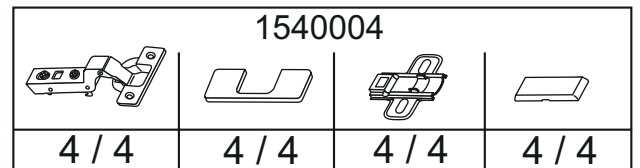
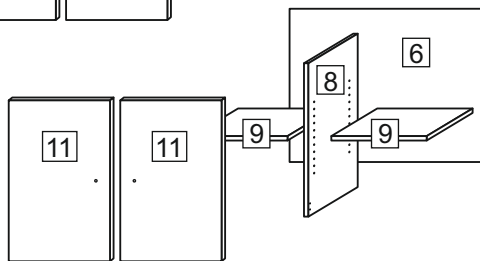
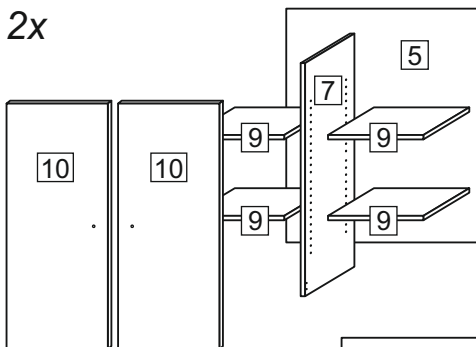

2x

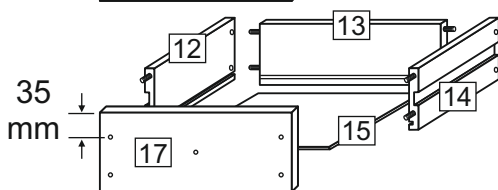
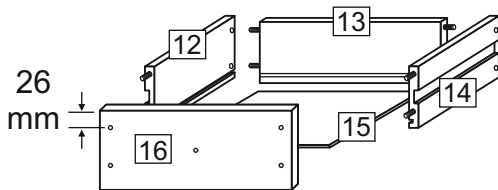

2x

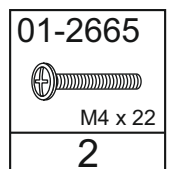
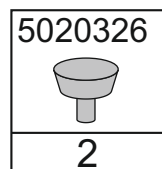
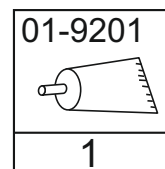
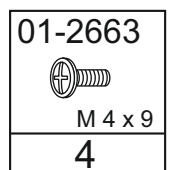
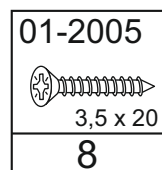
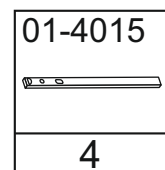

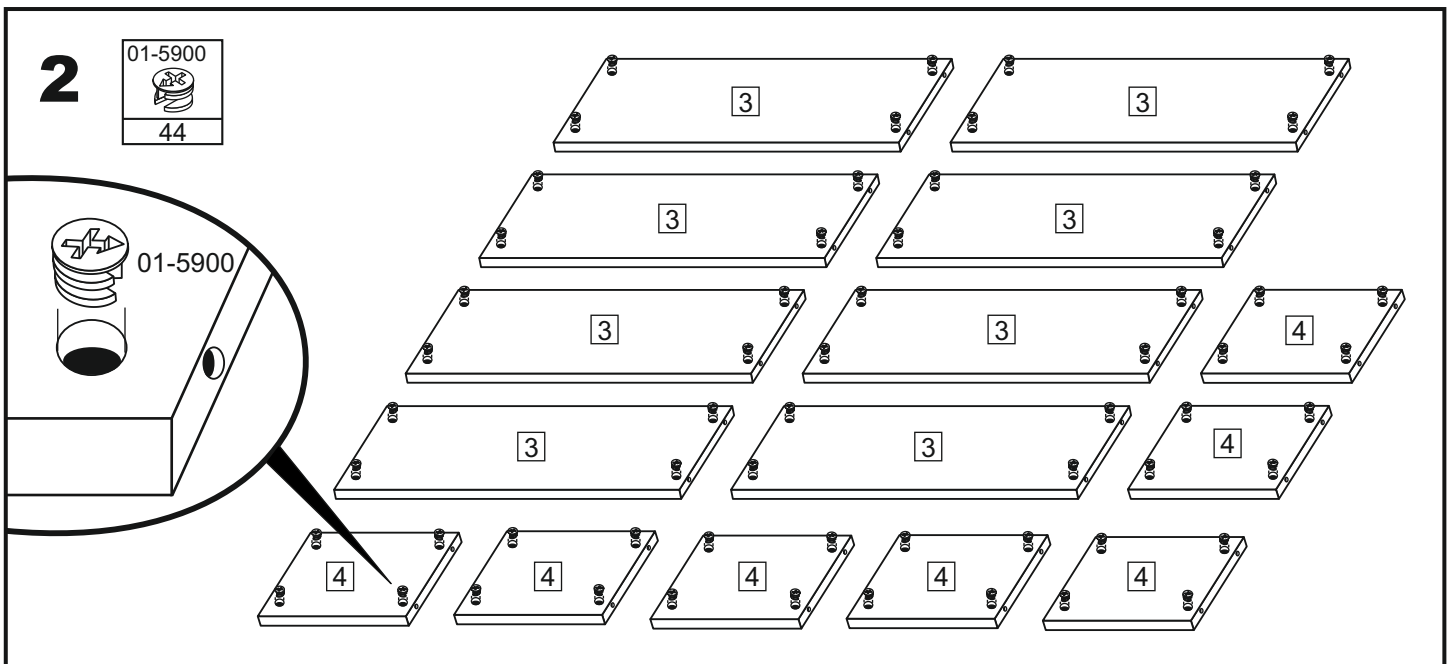
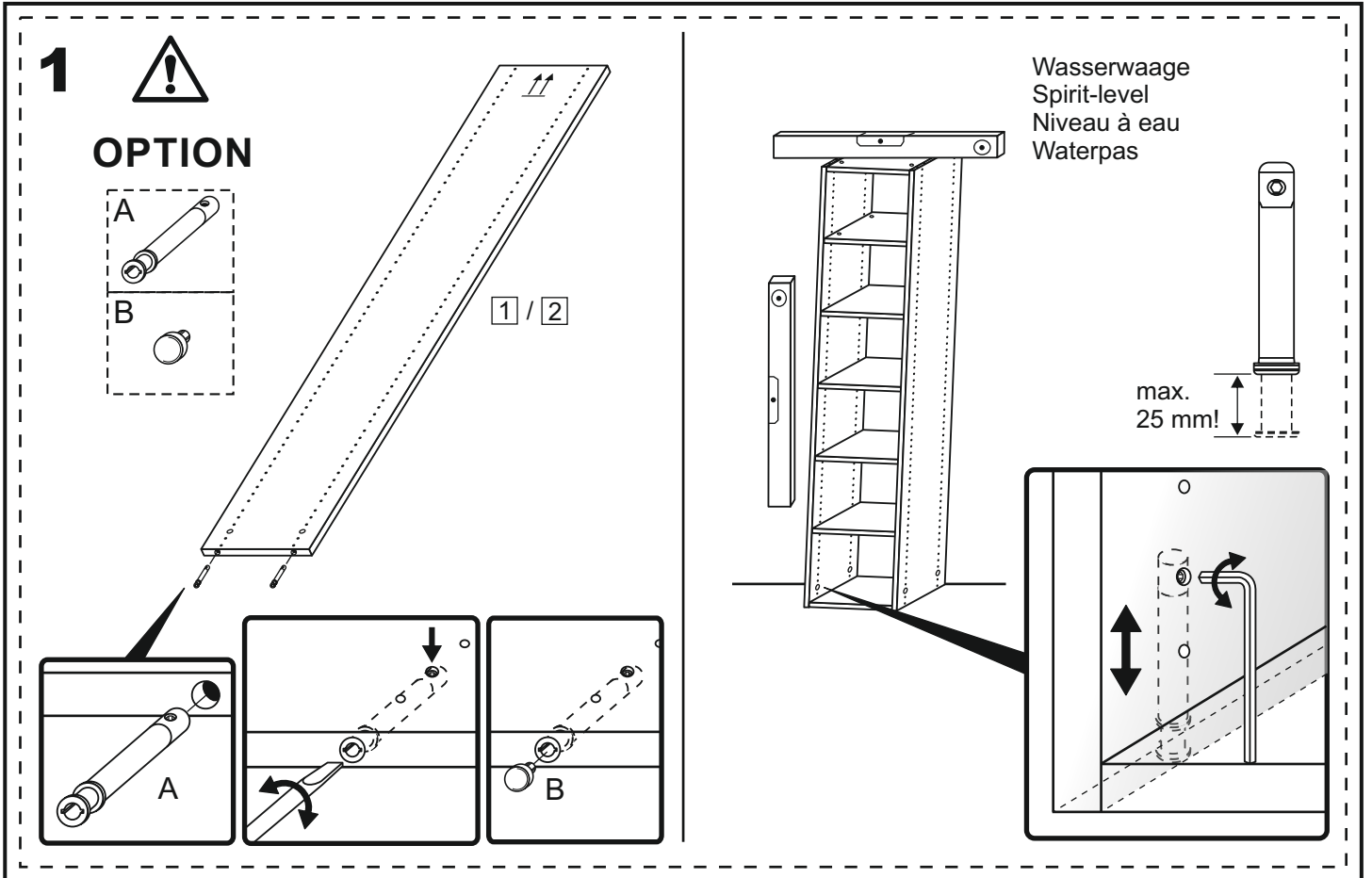
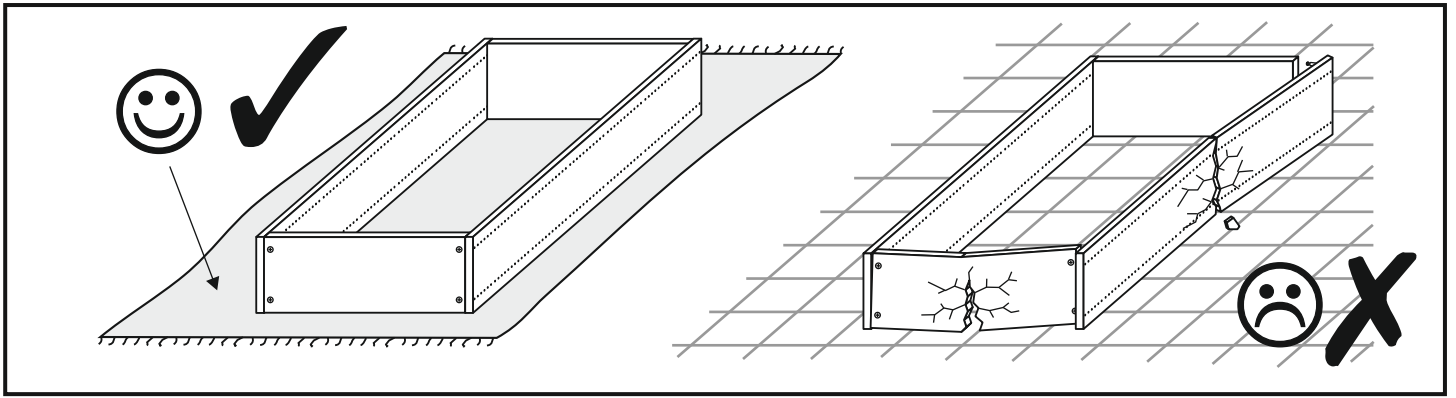



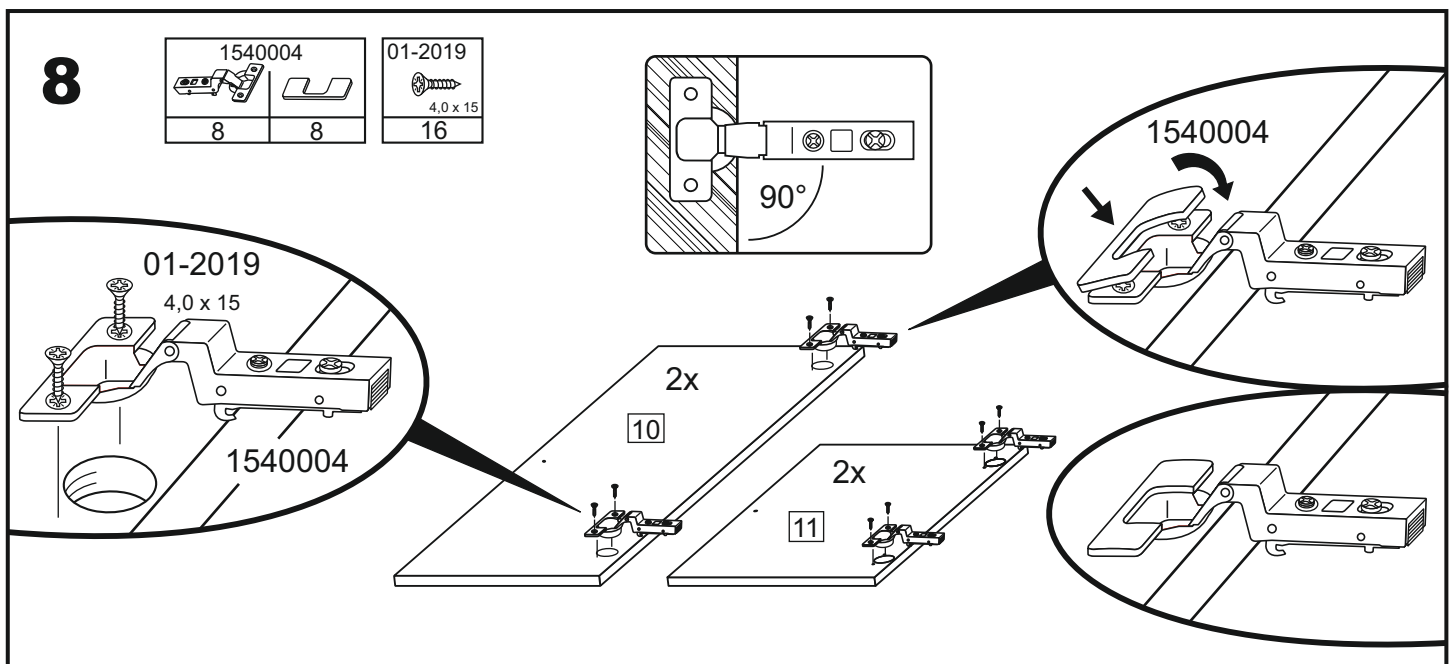
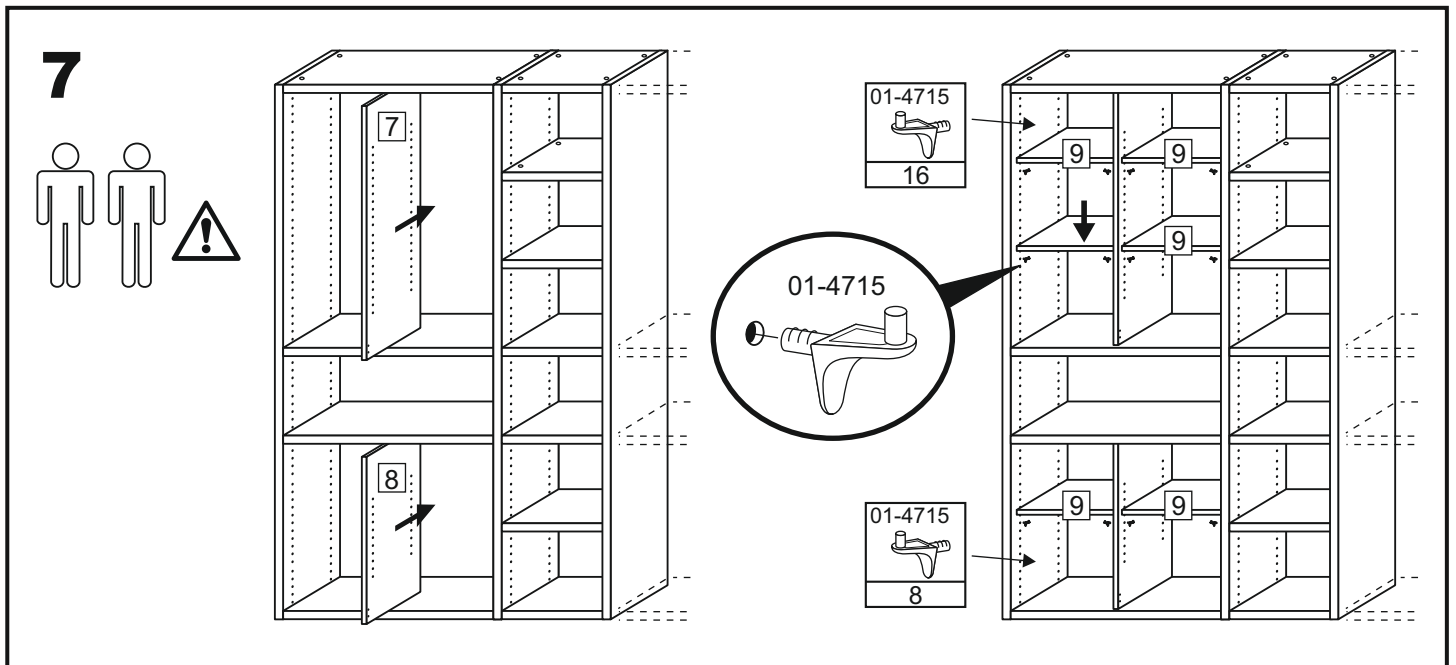
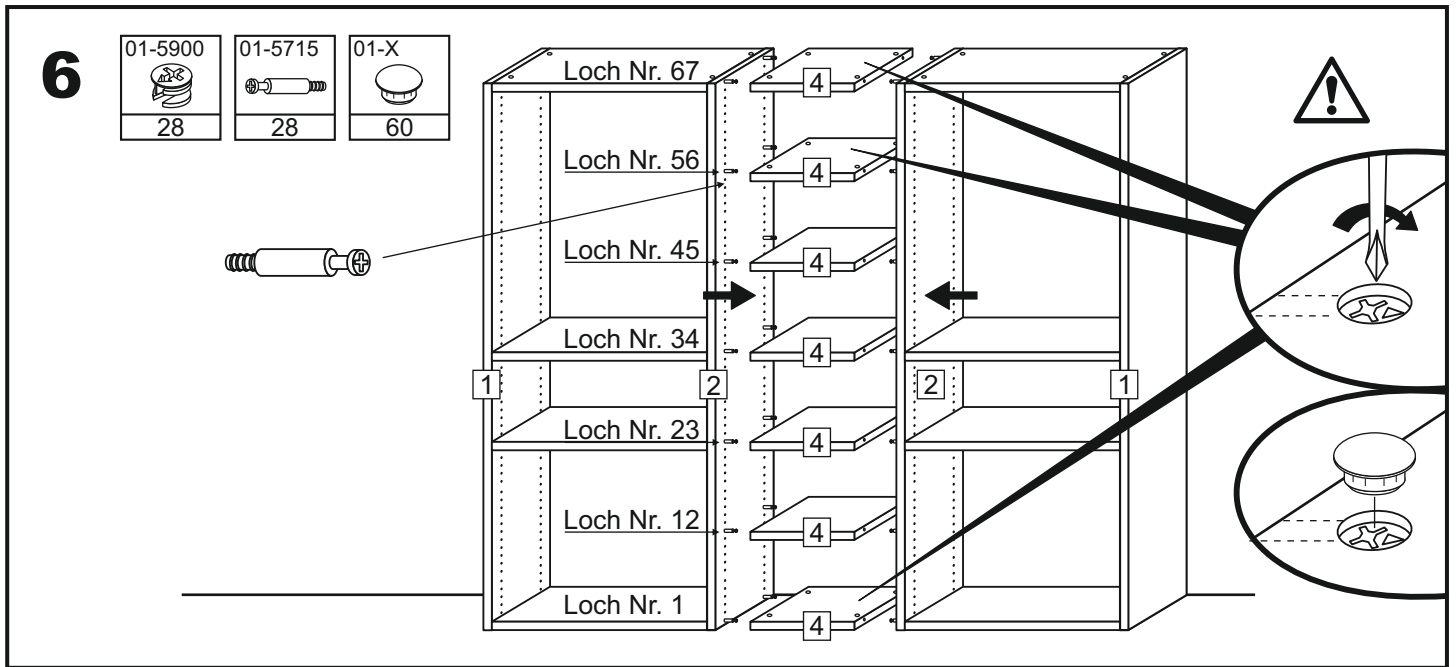

# 9

1540004



16

01-2045



3,0 x 13,5

32

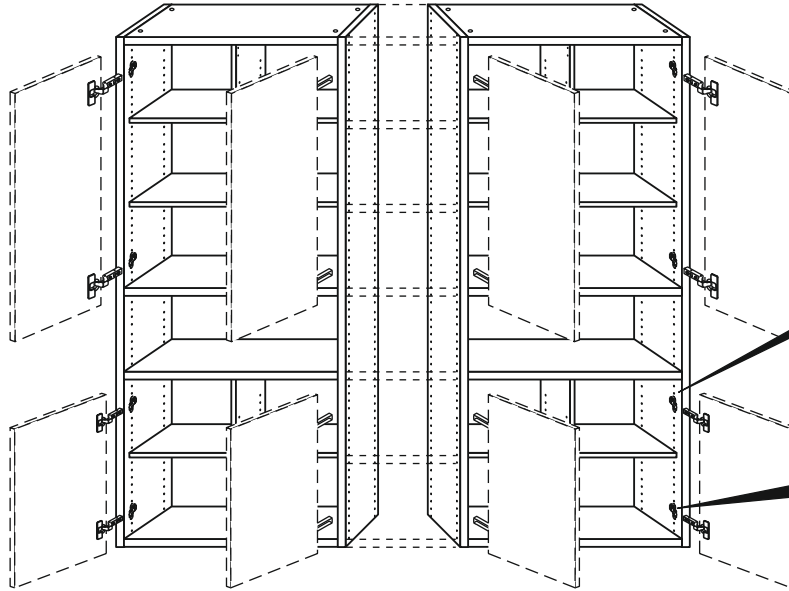

1540004

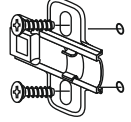

01-2045

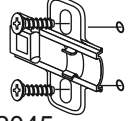

# 10

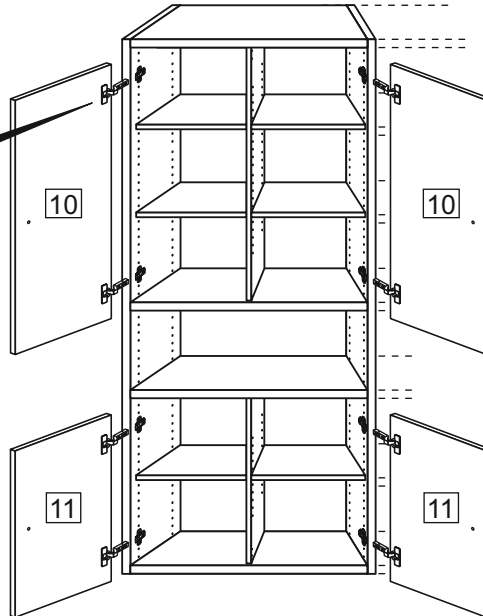
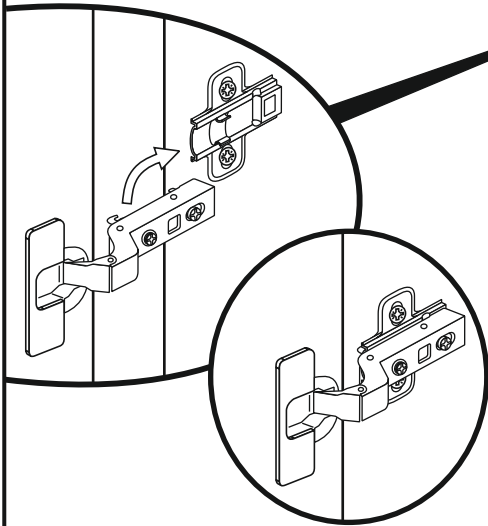

Demontage

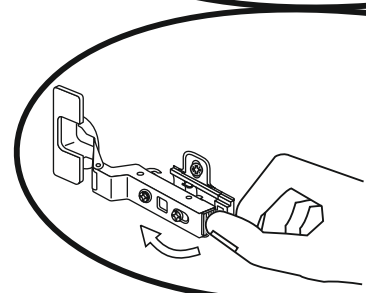
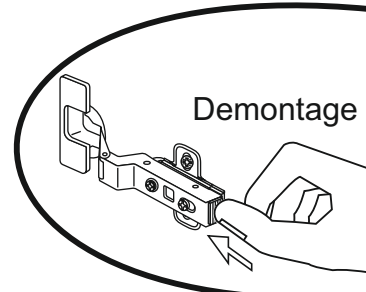

# 11

5020326



4

01-2665



M4 x 22

4

01-4205



4

1540004



8



01-4205

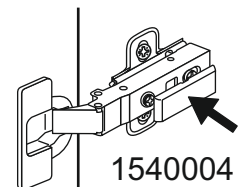
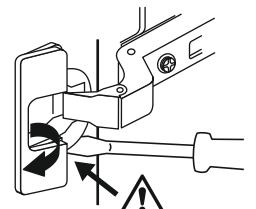
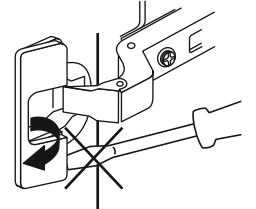
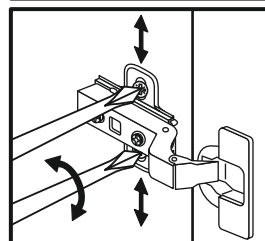
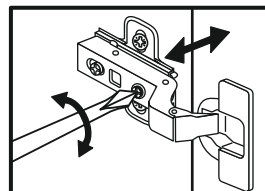
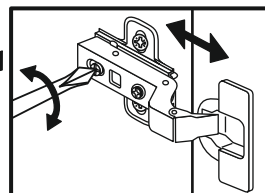
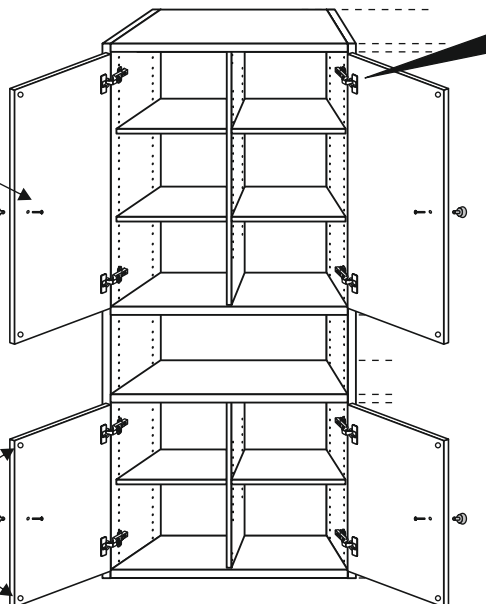

1540004

# 12

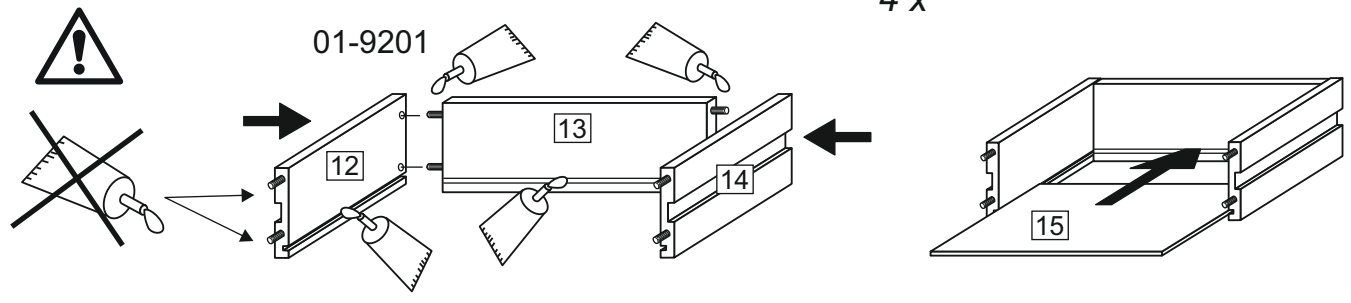
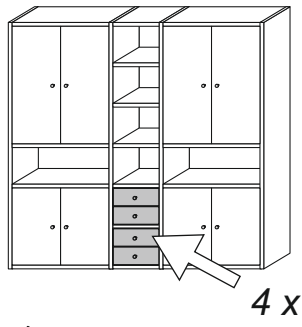
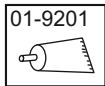

# 13

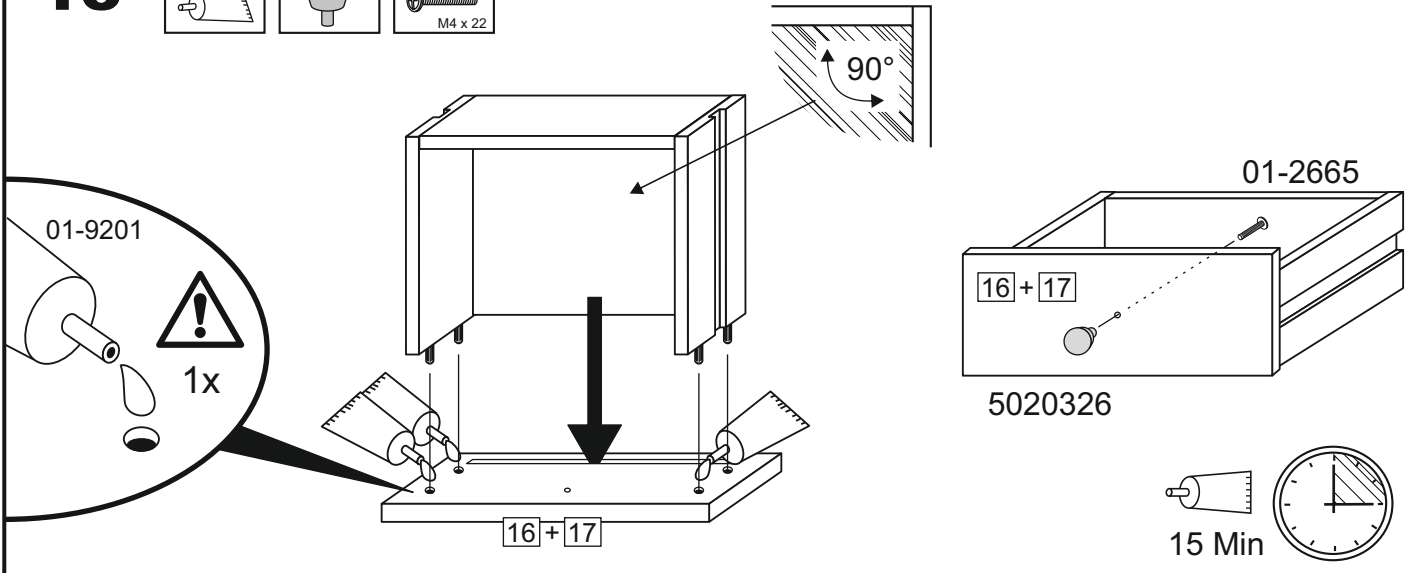
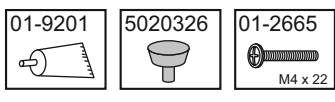

# 14

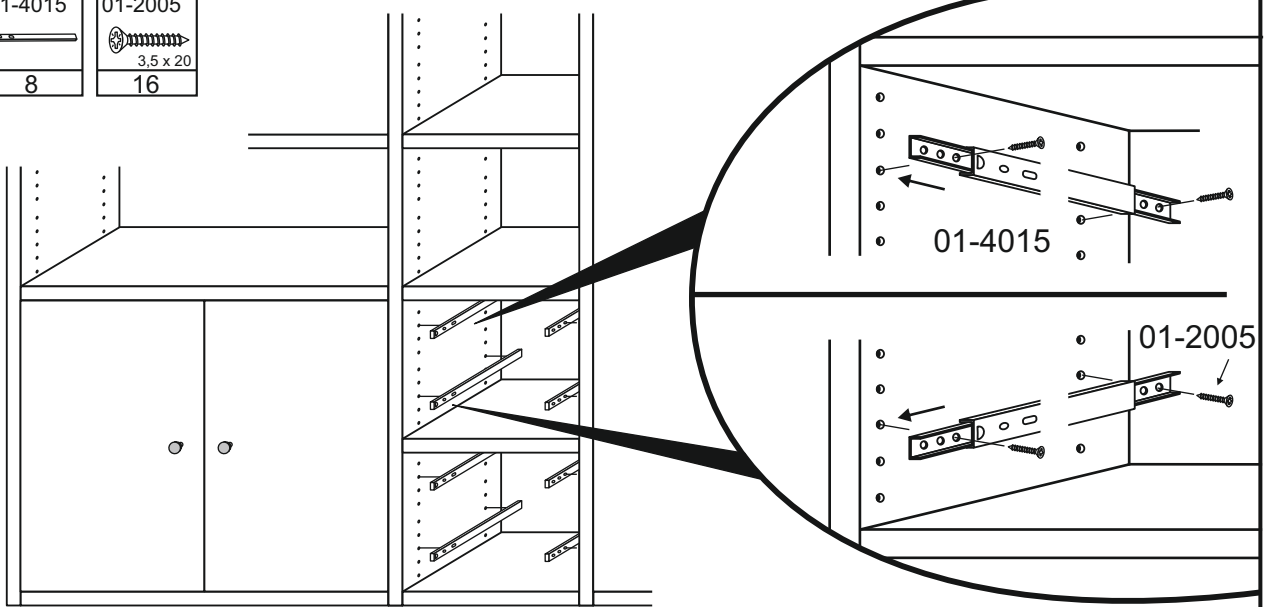
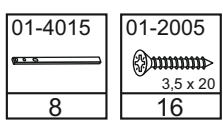

# 15

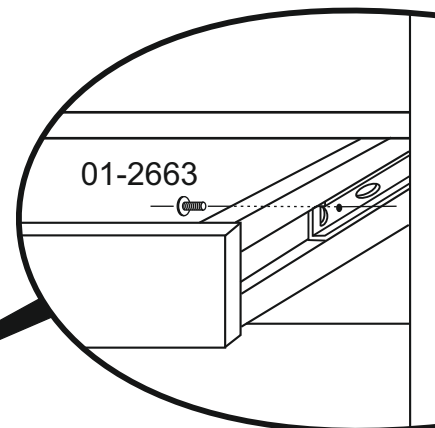
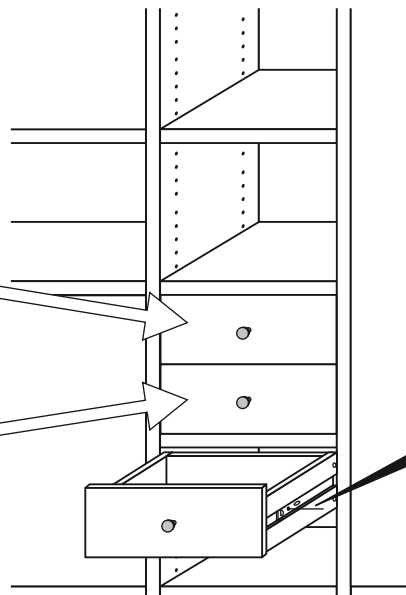
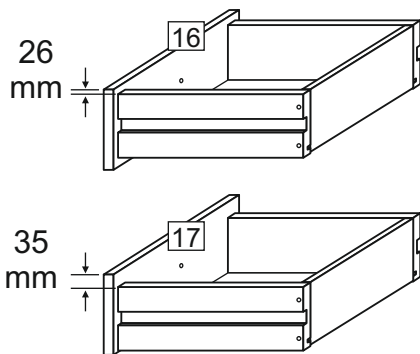

<b>Achtung · Attention · Attenzione · Opgelet · Uwaga · Pozor · Figyelem · Atentie · Dikkat · Внимание</b>			
D	Wandbefestigung dient als Kippschutz - unbedingt anbringen! Bei einigen Wandtypen kann ein Spezialdübel erforderlich sein!	CZ	Montáž na stěnu slouží jako ochrana proti převrnutí - bezpodmínečně umístěte! U některých typů stěn může být zapotřebí speciální hmoždinka!
GB	The wall fastening serves to prevent tipping - be absolutely sure to mount it! For certain wall types, a special dowel may be necessary!	SK	Upevnenie na stenu slúži ako ochrana proti prevráteniu - bezpodmienečne použite! Pre niektoré druhy stien môže byť potrebná špeciálna hmoždinka!
FR	La fixation murale sert de protection contre le basculement - à installer impérativement! Pour certains types de murs il faut des chevilles spéciales!	HU	A terméket a falhoz kel rögzíténi, különben az felborulhat! Egyes faltípusoknál speciális tiplít kell használni!
IT	Il fissaggio alla parete serve da protezione anti - ribaltamento - attaccarla assolutamente! Per alcune strutture di parete può essere necessario un tassello speciale!	RO	Sistemul de fixare la perete servește ca protecție la răsturnare - de montat obligatoriu! Pentru unele tipuri de pereți este posibil să fie necesar un diblu special!
NL	Bevestiging aan de muur dient als kantelbescherming - zeker en vast bevestigen! Bij enkele muurtypes is een speciale plug mis-schien vereist!	TR	Duvardaki sabitleme, devrilmeye karşı bir emniyet tedbiridir ve mutlaka monte edilmelidir! Bazi duvar tiplerinde bunan için özel bir dübel gerekli olabilir!
PL	Mocowanie do ściany jest jednocześnie zabezpieczeniem przed przewróceniem - koniecznie zamontować! Do niektórych rodzajów ścian koniecznie zastosować specjalne kołki mocujące.	RU	Обязательно установите крепление на стене во избежание опрокидывания! для некоторых типов стен может потребо ваться специальный дюбель!

# 16

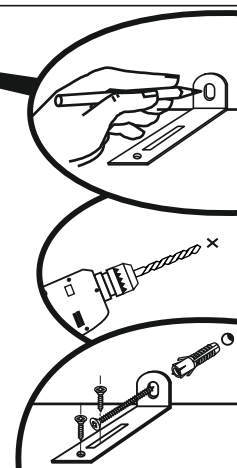
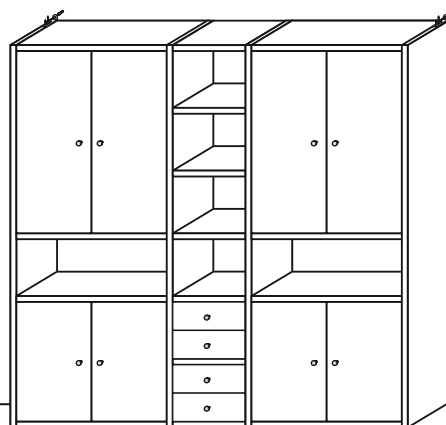
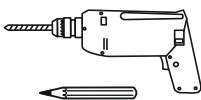
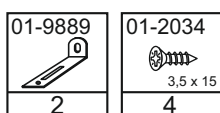

D	Bitte nur mit einem Staubtuch oder leicht feuchtem Lappen reinigen. Keine scheuernden Putzmittel verwenden.	CZ	Čistěte prosím jen prachovkou nebo lehce navlhčeným hadrem. Nepoužívejte drhnoucí čisticí prostředky.
GB	Please only clean with a duster or a damp cloth. Do not use any abrasive cleaners.	SK	Na čistenie používajte len prachovku alebo zľahka navlhčenú utierku. Nepoužívajte žiadne drhnuce čistiace prostriedky.
FR	Veillez nettoyer uniquement avec un chiffon à poussière ou un chiffon légèrement humide. Ne pas utiliser de détergent abrasif.	HU	Kérjük, csak portörölő kendővel vagy enyhén nedves ronggyal tisztítsa. Ne használjon dörzsható tisztítószert.
IT	Si raccomanda di pulire solo con un panno per la polvere o uno strofinaccio umido. Non utilizzare detergenti abrasivi.	RO	Vă rugăm să utilizați la curățare exclusiv o cârpă de șters praful sau o cârpă ușor umezită. Nu utilizați substanțe de curățat abrazive.
NL	Reinig alleen met een stofdoek of een lichtjes vochtige doek. Gebruik geen schurende poetsmiddelen.	TR	Lütfen sadece bir toz bezikle veya hafif nemli yumuşak bir bezle siliniz. Aşındırıcı temizlik malzemeleri kullanmayınız.
PL	Czyszczenie należy wykonać wyłącznie za pomocą ściereczki lub lekko nawilżonego ręcznika. Nie stosować środków czyszczących do szorowania.	RU	Очищайте от пыли тряпкой или слегка влажной ветошью. Не допускается применение чистящих средств, не предназначенных для ухода за мебелью.