

(D) Montageanleitung

(GB) Assembly instructions

(NL) Handleiding voor de montage

(PL) Instrukcja montażu

(TR) Montaj talimatı

(RU) Инструкция по монтажу



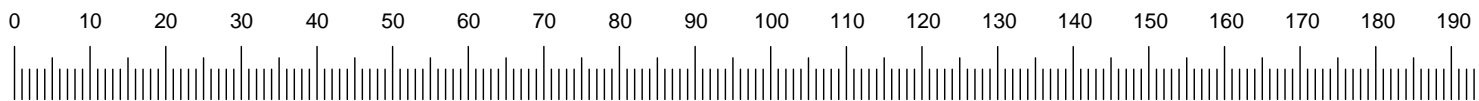
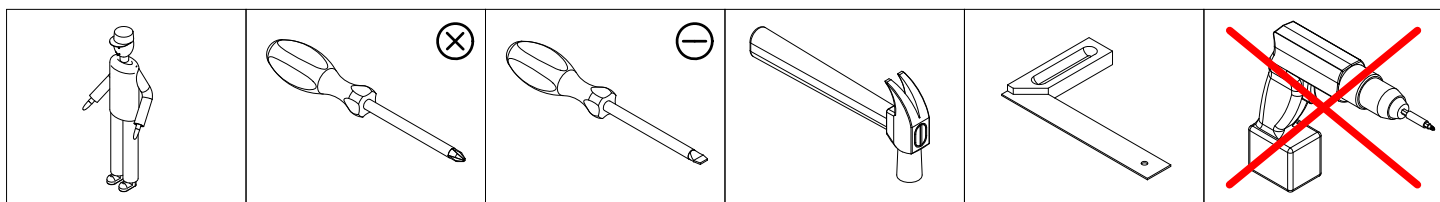

Service • Dienstverlening • Serwis • Servis • Сервисная служба

Name • Naam • Nazwa • İsim • Название	
Nr. • No. • Номер	
Typ • Type • Tip • Тип	

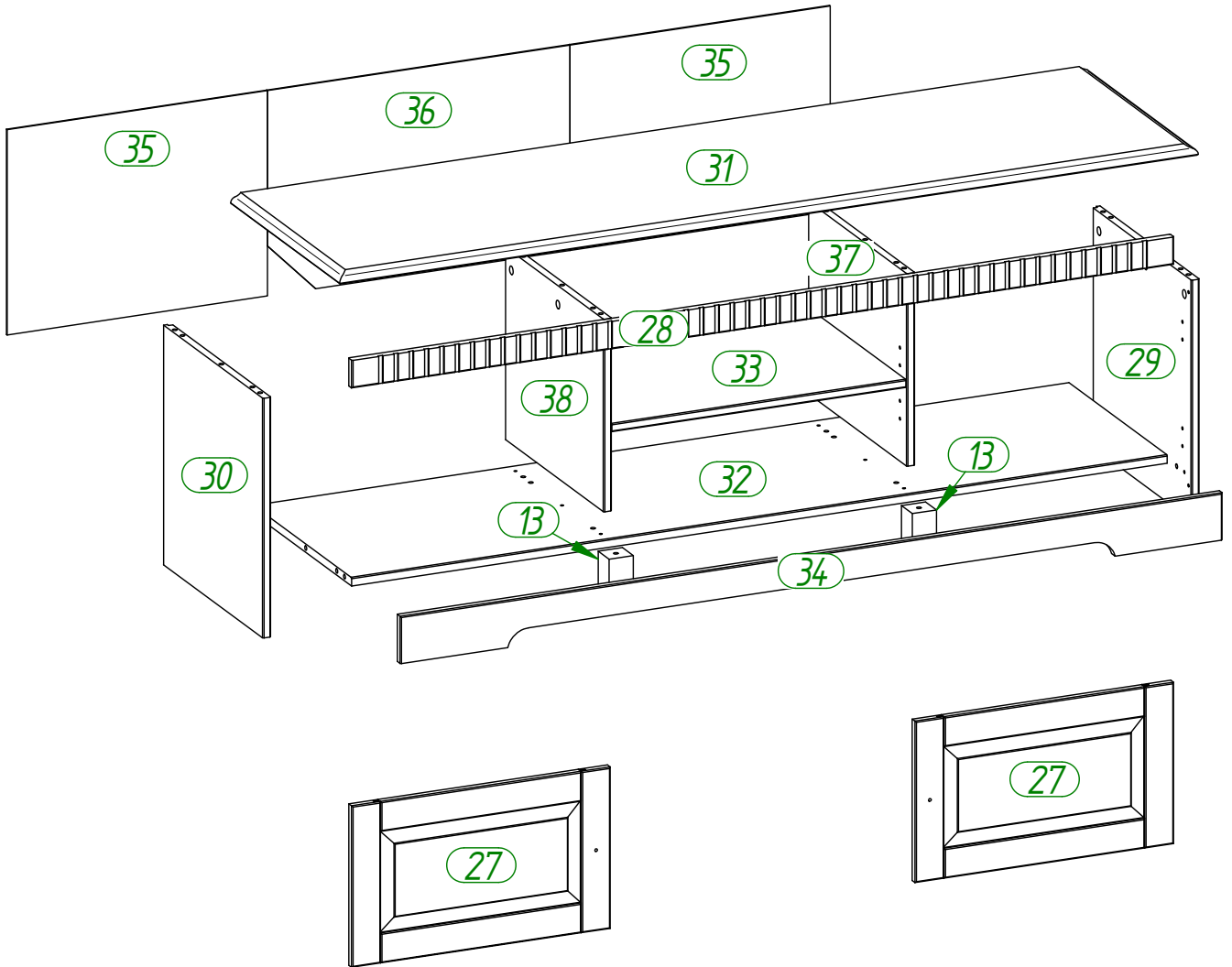
A 18 x Ø8 x 35	Ba 20 x Ø6,3 x 12	C 4 x 2 mm	Ce 4 x fk.9	Ea 8 x Ø3,5 x 15	En 2 x Ø4,0 x 35
Fb 1 x 3 mm	Fa 1 x	G 18 x L - 34	Ga 18 x Ø15 x 11	Hc 6 x Ø5 x 50	I 50 x Ø1,2 x 20
Ib 1 x 45 x 20 x 16	K 10 x 20 x 20 x 16	N 4 x Ø5 / Ø5	Pc 2 x Ø34 x 29		





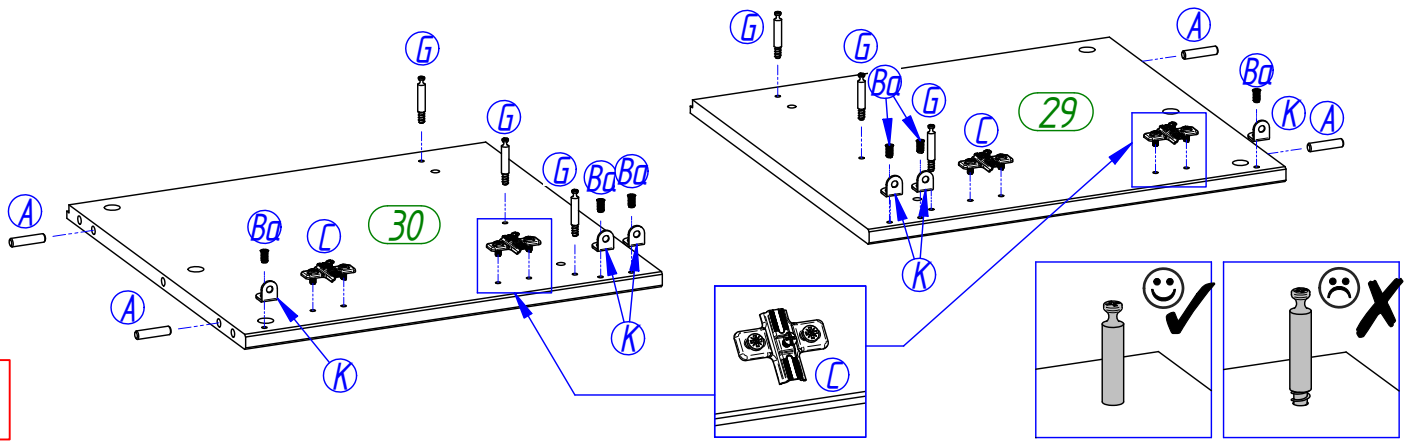

A	4 x	Ba	6 x	C	4 x	G	6 x	K	6 x
									
Ø8 x 35		Ø6,3 x 12		2 mm		L - 34		20 x 20 x 16	

1



A	12 x	Ba	4 x	K	4 x
					
Ø8 x 35		Ø6,3 x 12		20 x 20 x 16	

2

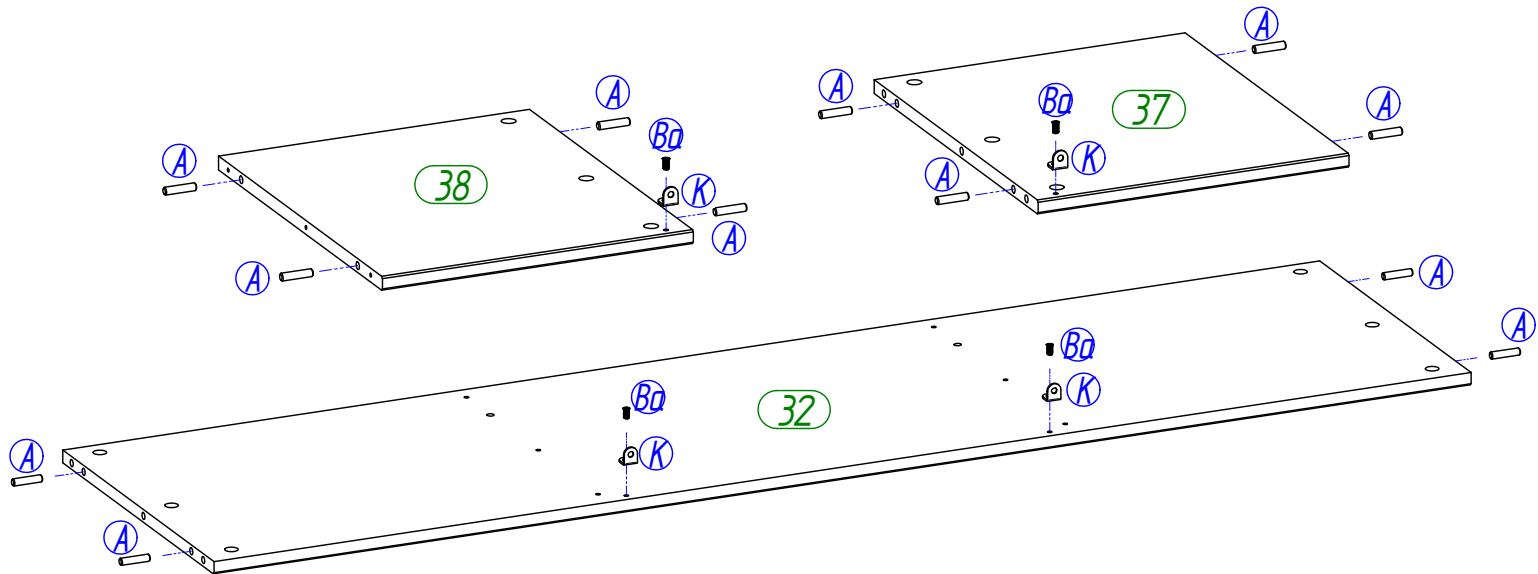

G	12 x
	
L - 34	

3

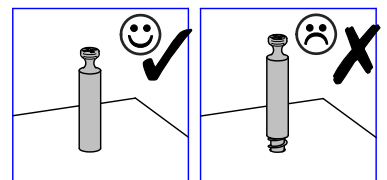
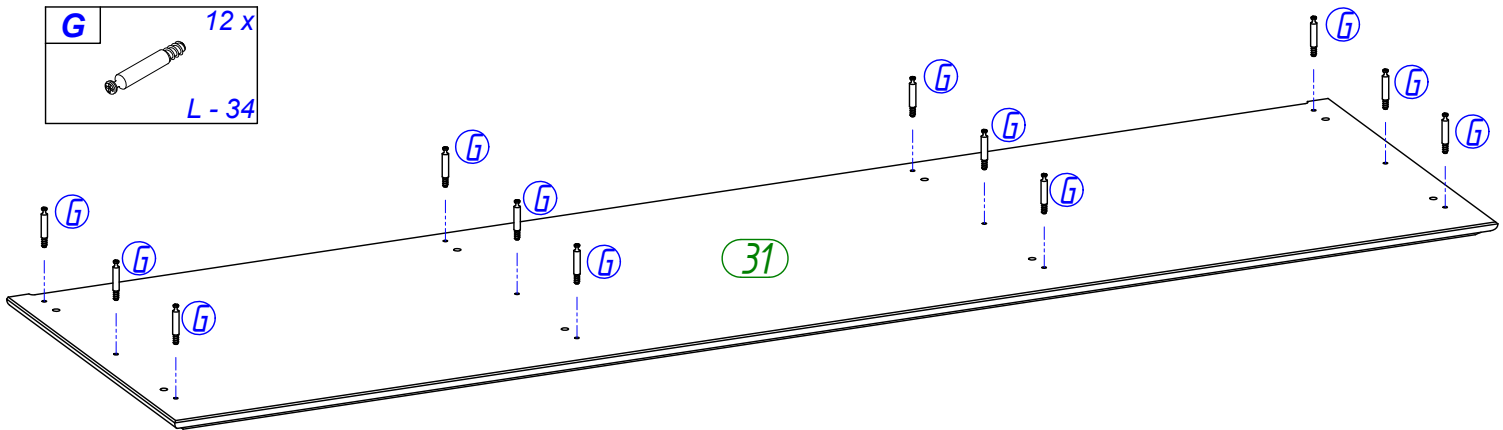

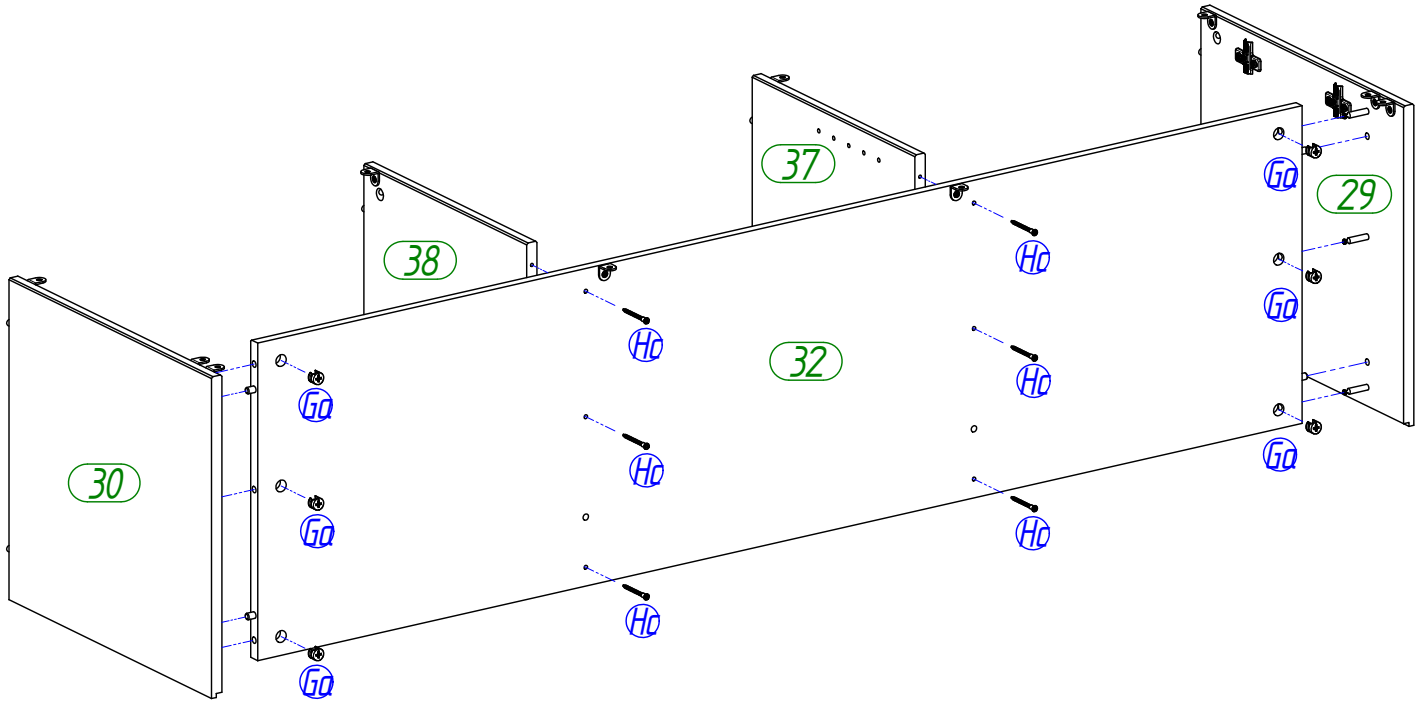
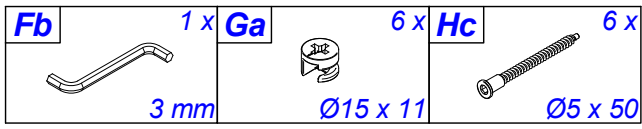

4

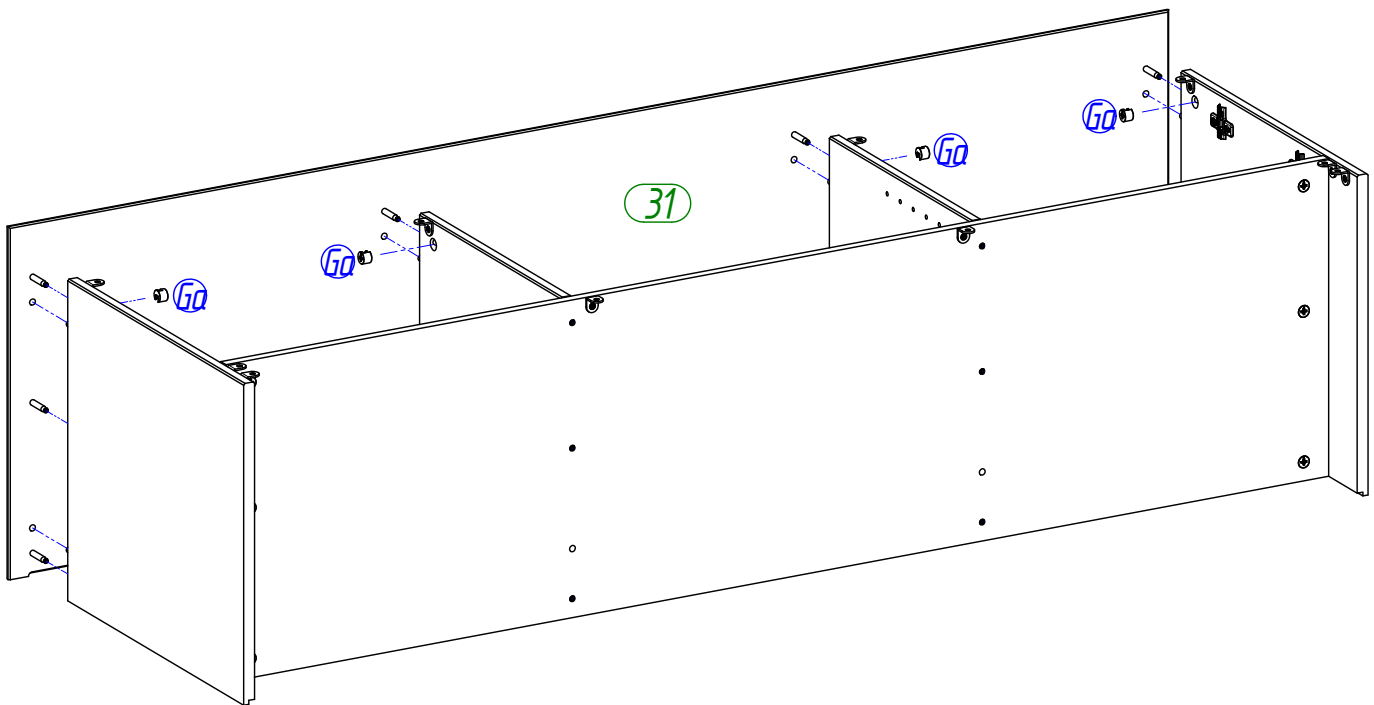
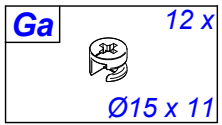

5

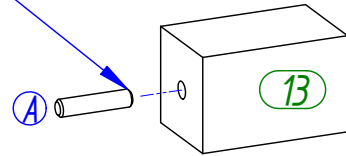
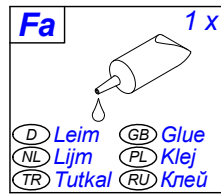
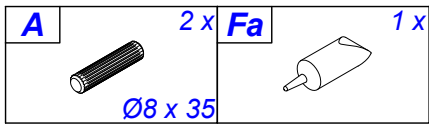



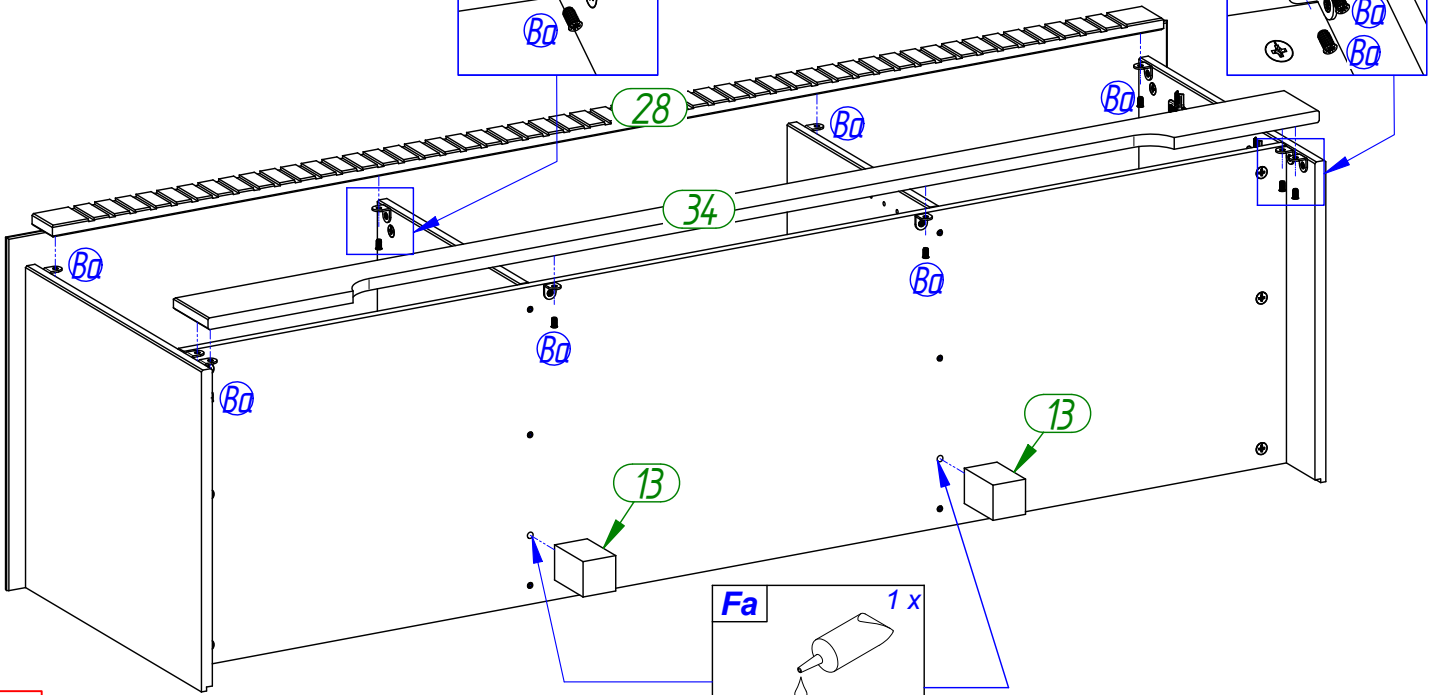
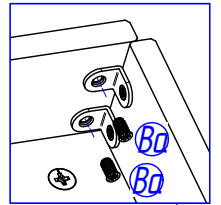
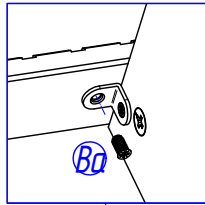
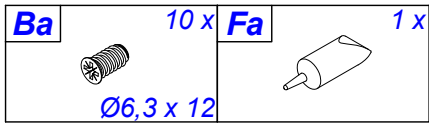

6 2x

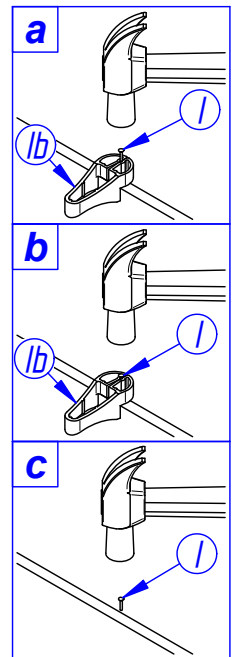
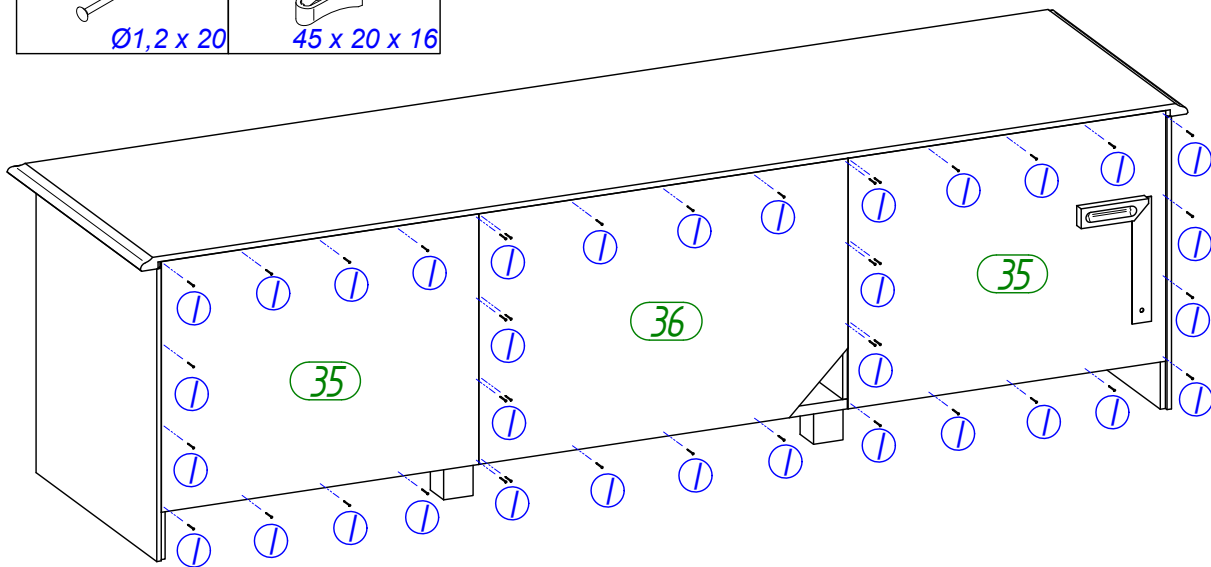
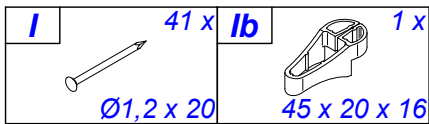
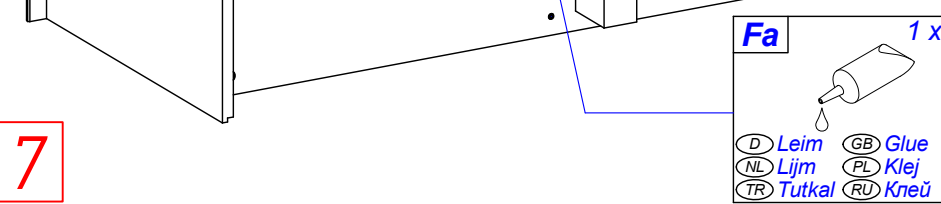

7

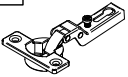

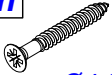
8

Ce	4 x	Ea	8 x	En	2 x	Pc	2 x
	<i>fk.9</i>		$\text{Ø}3,5 \times 15$		$\text{Ø}4,0 \times 35$		$\text{Ø}34 \times 29$

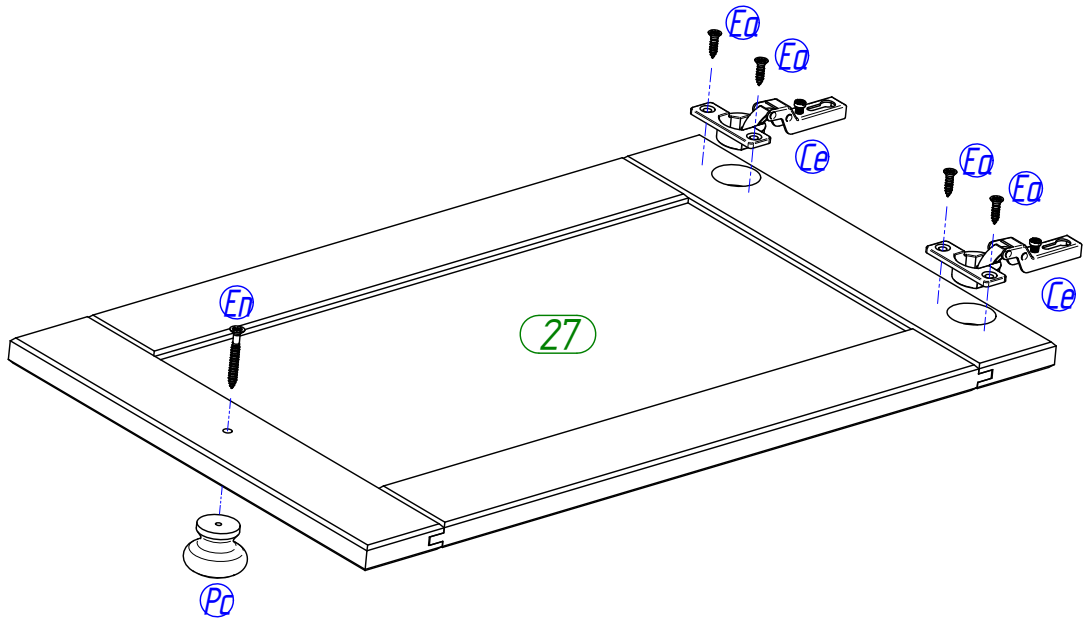

9 x2

N	4 x
	$\text{Ø}5 / \text{Ø}5$

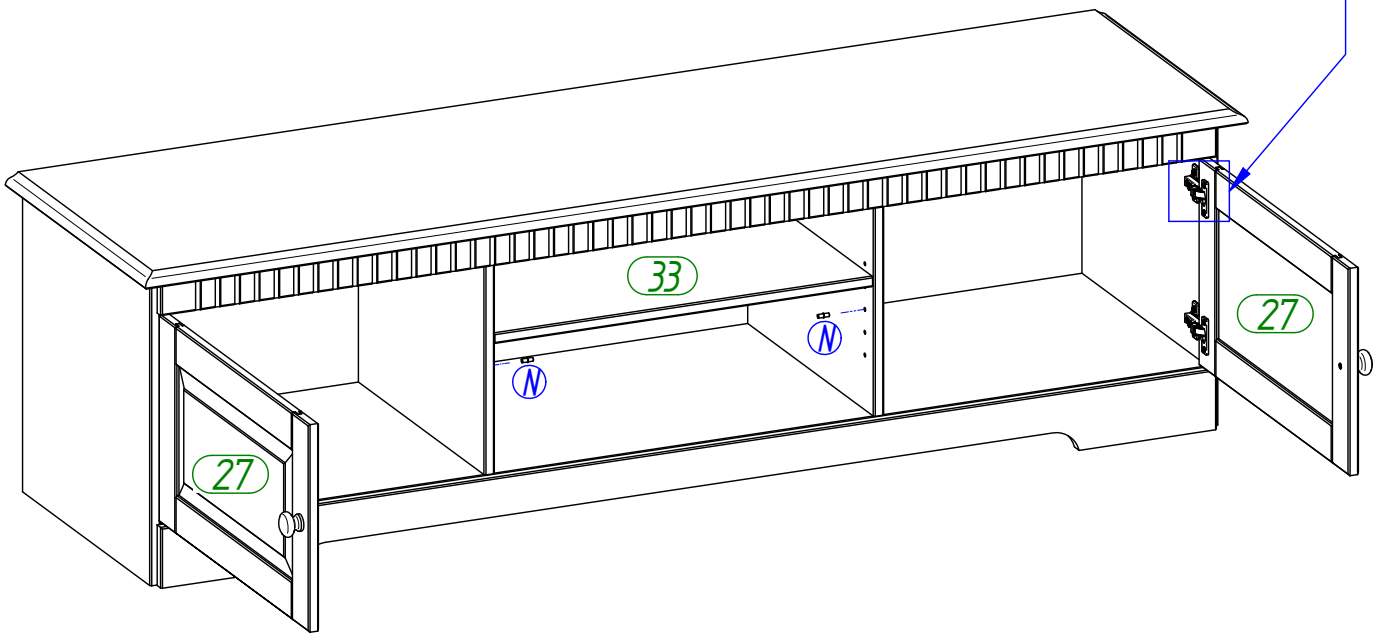
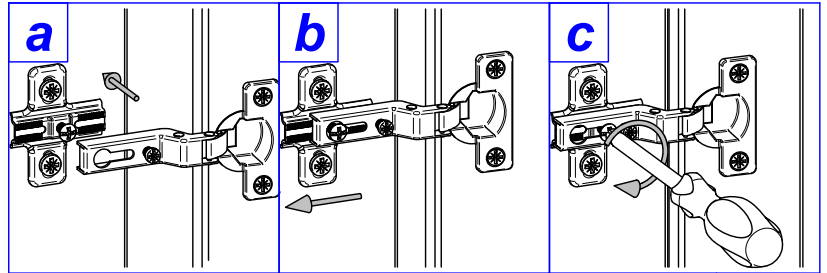

10

D	<i>Türen einstellen (Scharniere justieren)</i>
GB	<i>Adjusting the doors (adjusting the hinges)</i>
NL	<i>Deuren instellen (scharnieren afstellen)</i>
PL	<i>Nastawić drzwi (wyrównać zawiasy)</i>
TR	<i>Kapıların ayarlanması (menteşelerin seviye ayarı)</i>
RU	<i>Регулировка дверей (регулировка шарнира)</i>

