

LEANDRO V
8141/2503
2501/8142

- | | | | |
|-----------|--|-----------|---|
| D | MONTAGEANLEITUNG
BEDIENUNGSANLEITUNG | GB | ASSEMBLY INSTRUCTIONS
INSTRUCTION MANUAL |
| NL | HANDLEIDING VOOR DE MONTAGE
GEBRUIKSAANWIJZING | PL | INSTRUKCJA MONTAŻU
INSTRUKCJA OBSŁUGI |
| TR | MONTAJ TALIMATI
KULLANIM KLAVUZU | RU | ИНСТРУКЦИЯ ПО МОНТАЖУ
ИНСТРУКЦИЯ ПО ЭКСПЛУАТАЦИИ |
| RO | INSTRUCȚIUNI DE INSTALARE
INSTRUCȚIUNI DE UTILIZARE | IT | ISTRUZIONI DI MONTAGGIO
MANUALE DI ISTRUZIONI |
| FR | NOTICE DE MONTAGE
MANUEL INSTRUCTIONS | SK | MONTÁŽNY NÁVOD
NÁVOD NA POUŽITIE |
| HU | KÖZGYŰLÉS UTASÍTÁSOK
KEZELÉSI UTASÍTÁS | CZ | MONTÁŽNÍ NÁVOD
NÁVOD K POUŽITÍ |
| SI | NAVODILA ZA MONTAŽO
NAVODILA ZA UPORABO | PT | INSTRUÇÕES DE MONTAGEM
MANUAL DO USUÁRIO |
| ES | INSTRUCCIONES DE MONTAJE
MANUAL DEL USUARIO | HR | UPUTE ZA MONTAŽU
UPUTE ZA UPOTREBU |

F/B

230105

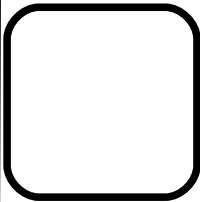
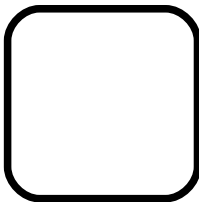

0019

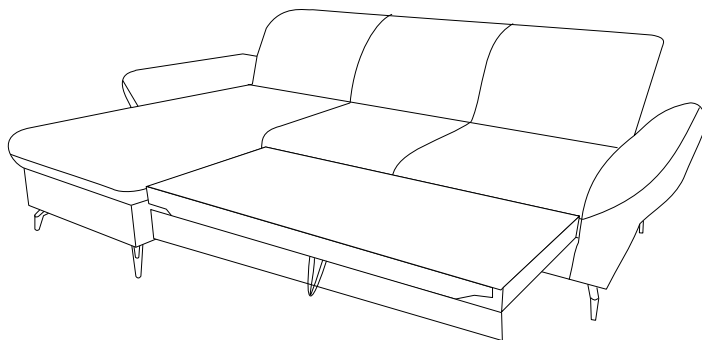
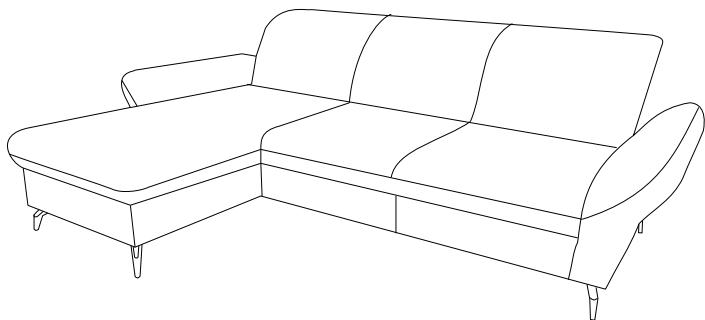

0019

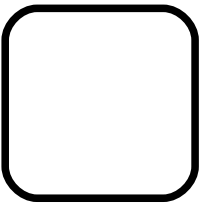
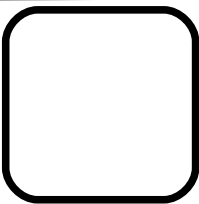

0089

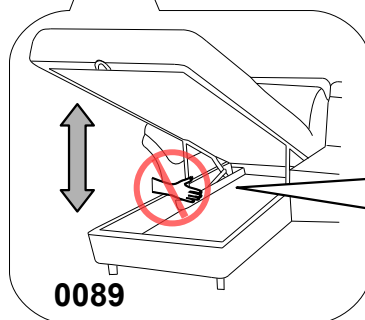
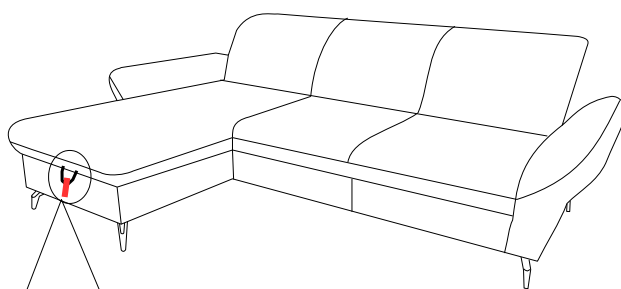
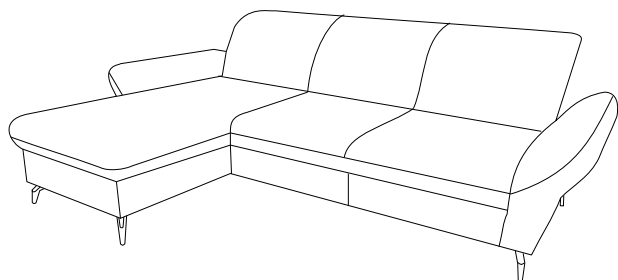
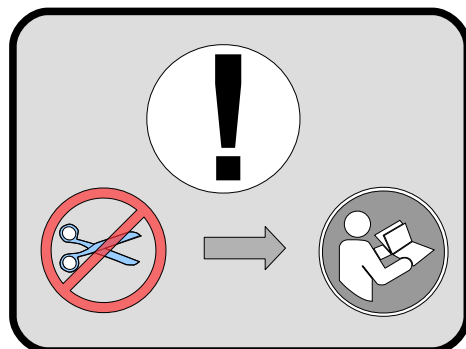

0089



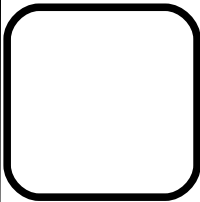
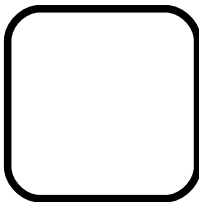

0037

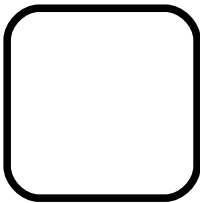
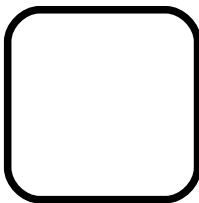
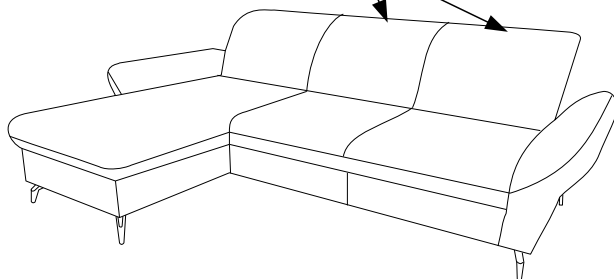
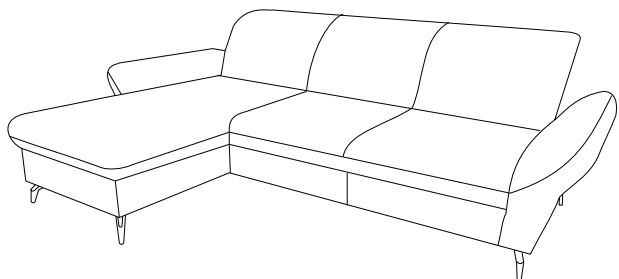
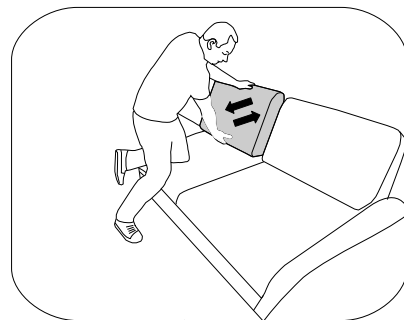

0037

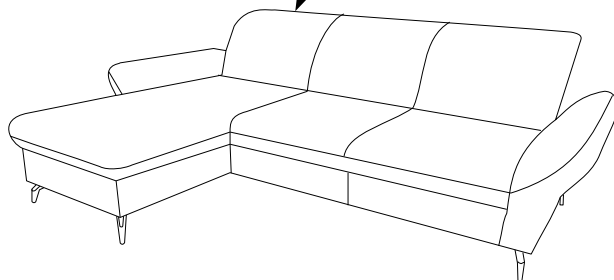
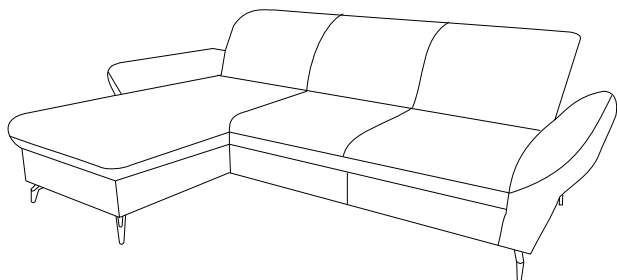
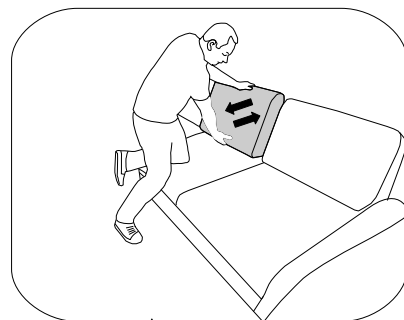

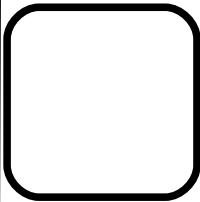
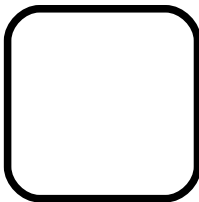

0090

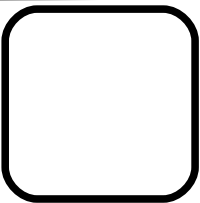
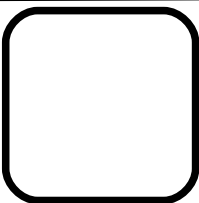
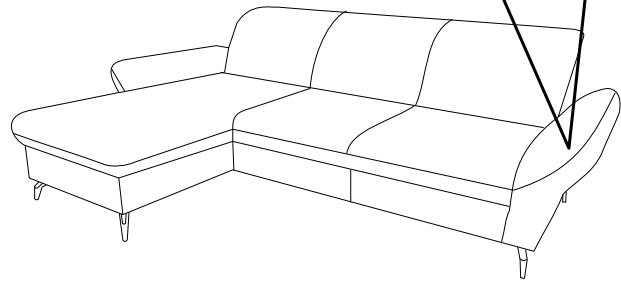
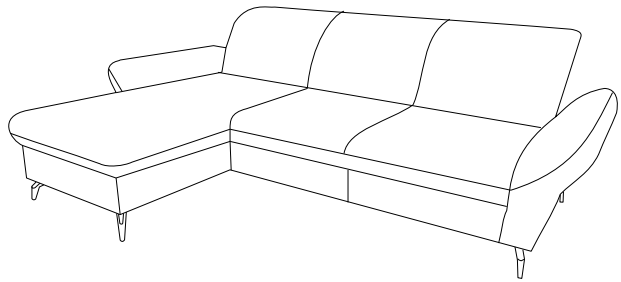
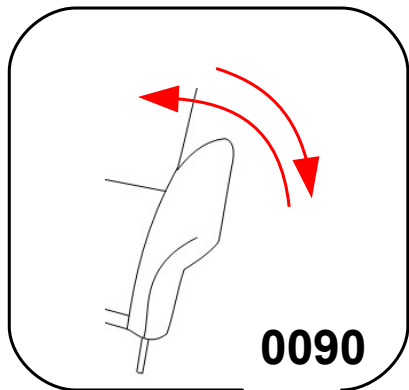

0090

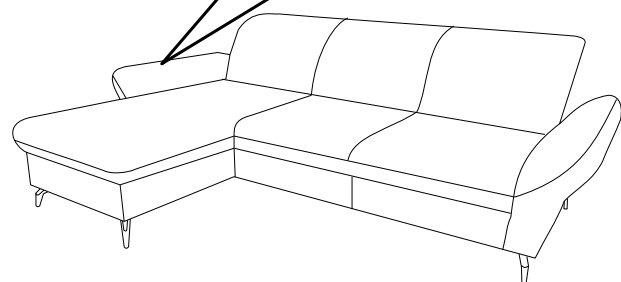
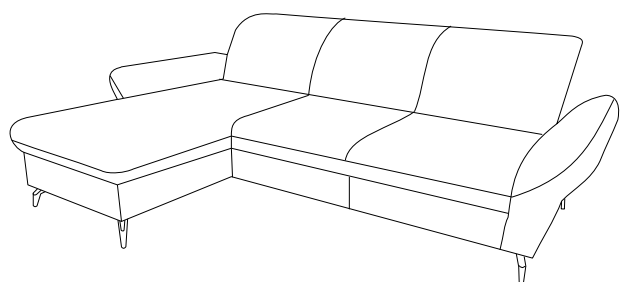
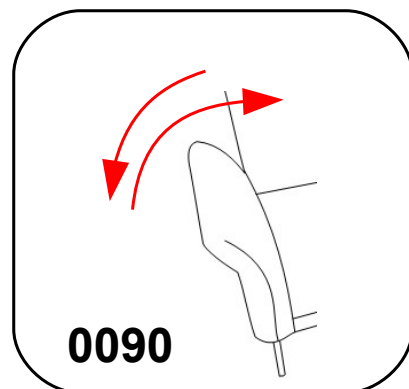

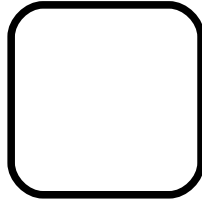
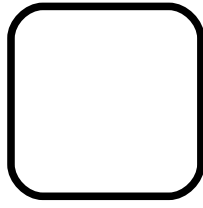

0064

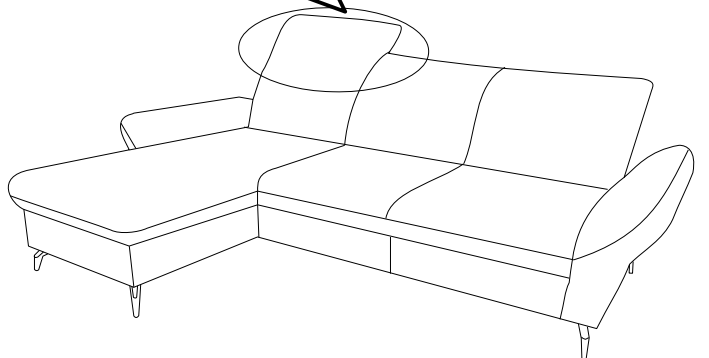
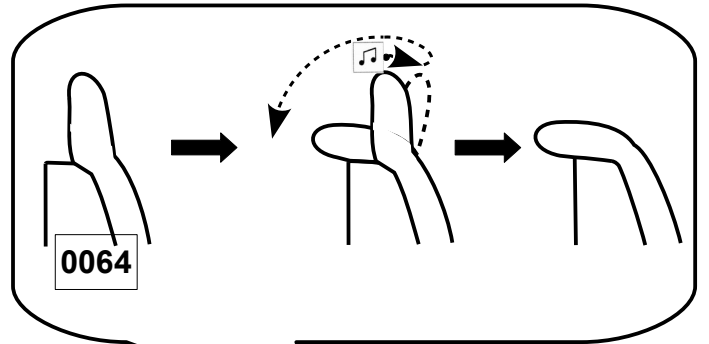
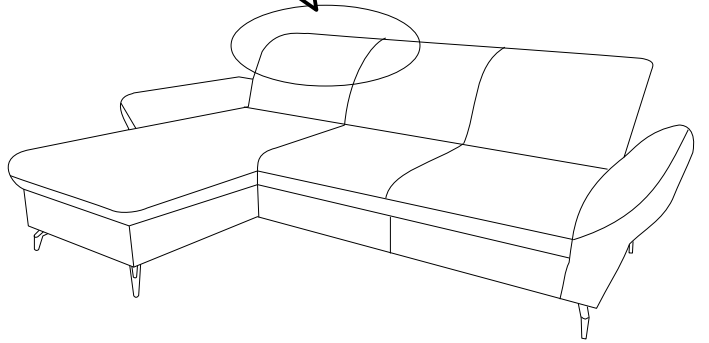
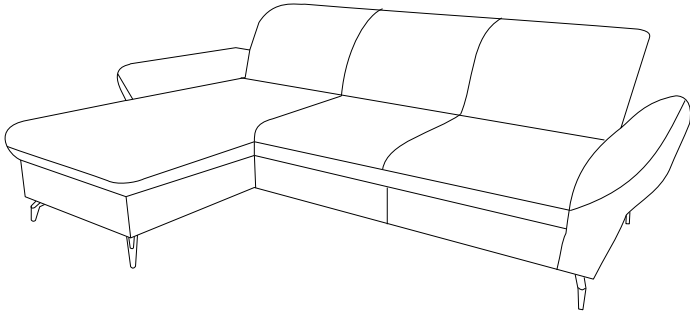
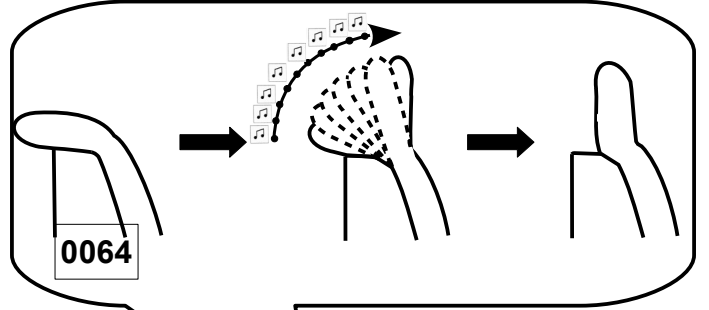



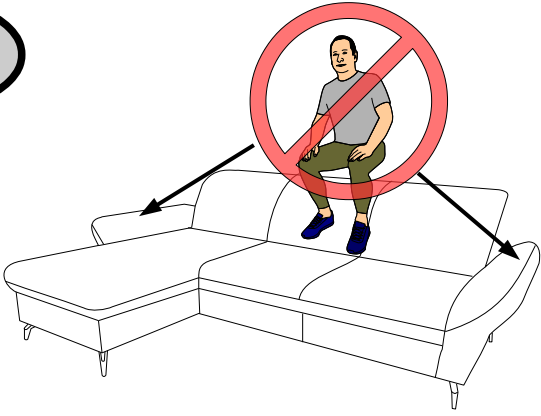

L

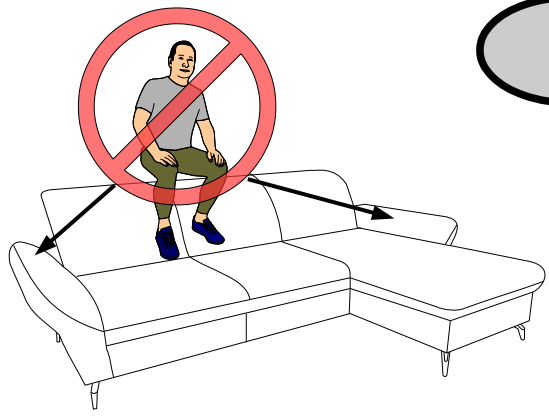

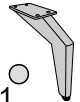

R

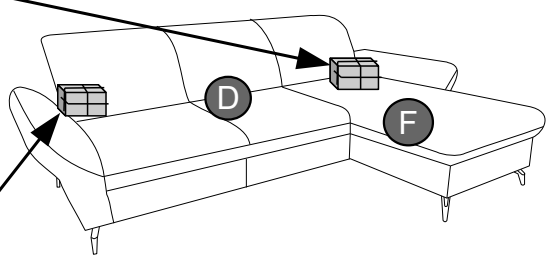
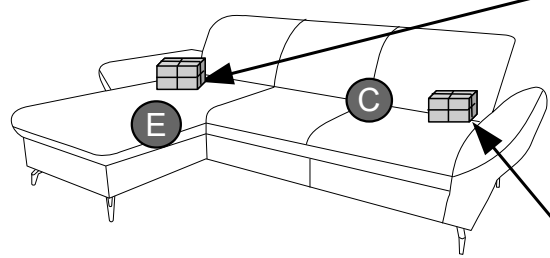

g H-120  X1	v H-120  X1	i L-4  X1	s H-120  X4	q M6*25 [mm]  X16
---	---	---	--	---

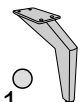

i L-4  X1	s H-120  X2	q M6*25  X8
---	---	--

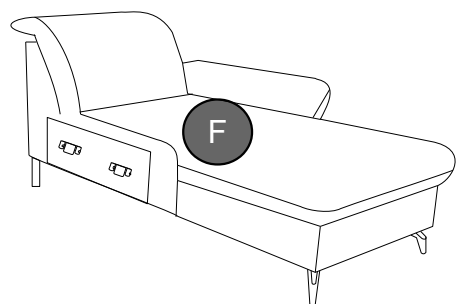
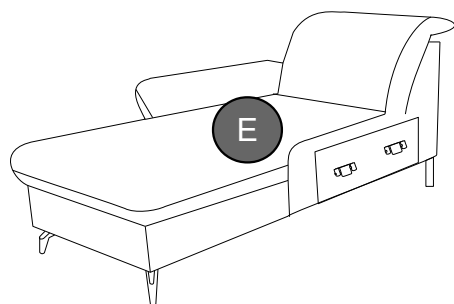
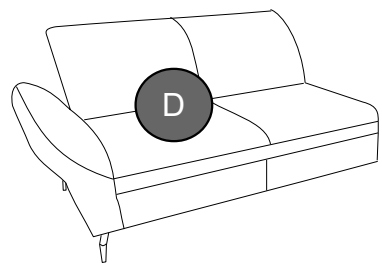
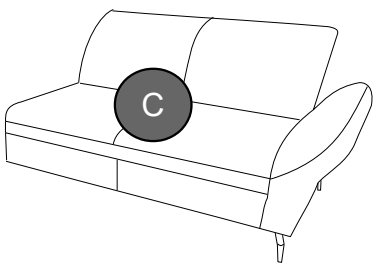

0
10
20
30
40
50
60
70
80
90
100
110
120
130
140
150
160
170
180
190
200

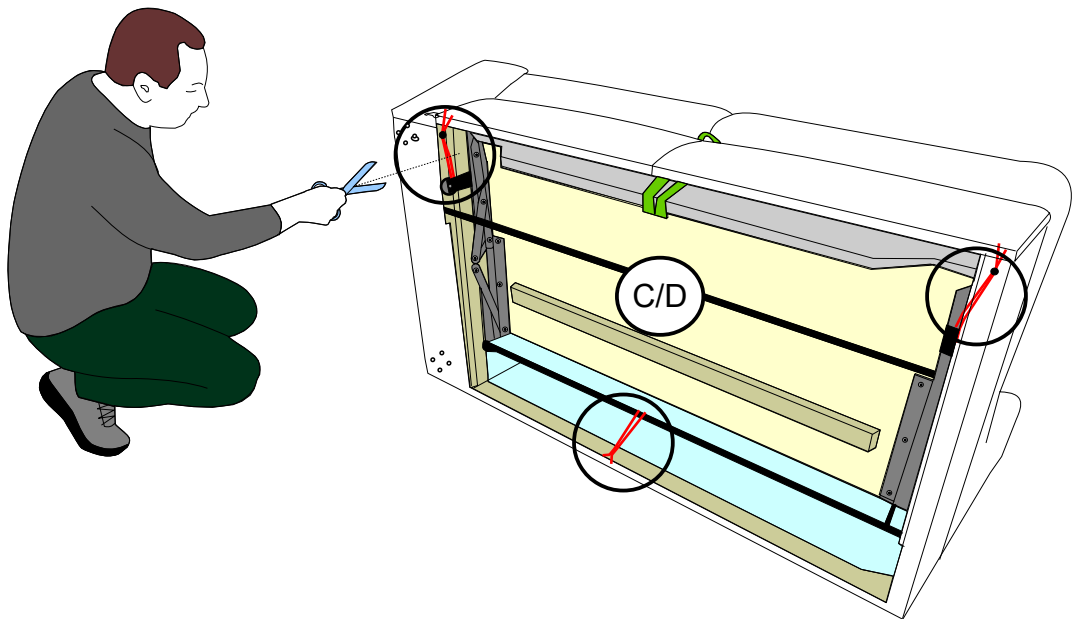
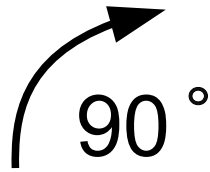
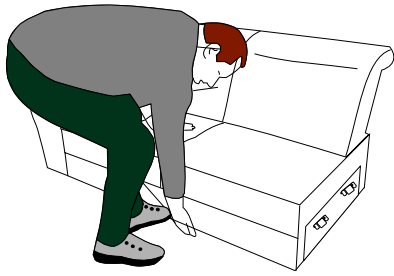

0019

g H- 120



X1

v H- 120



X1

i L- 4



X1

s H- 120



s₁

X6

q M6*25



24

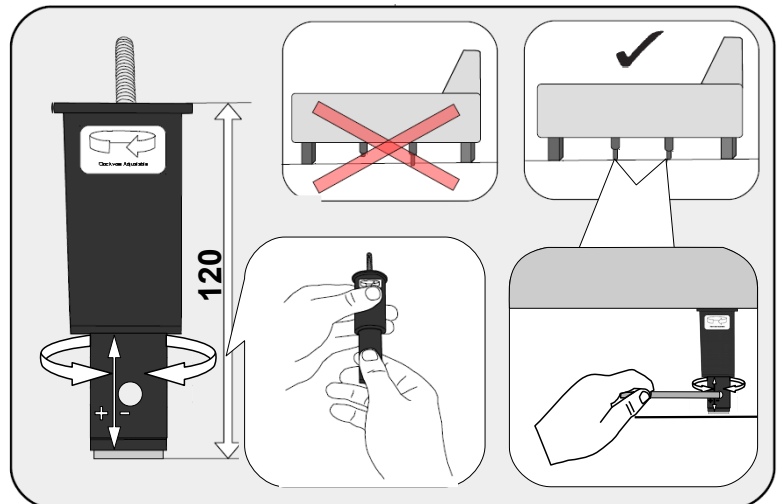
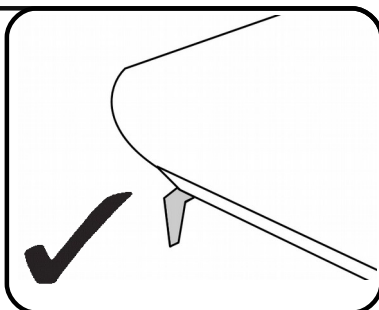
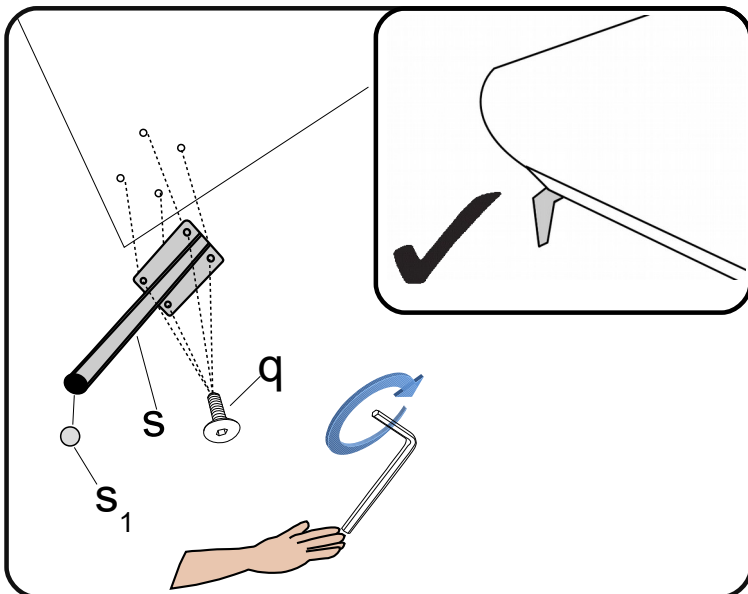
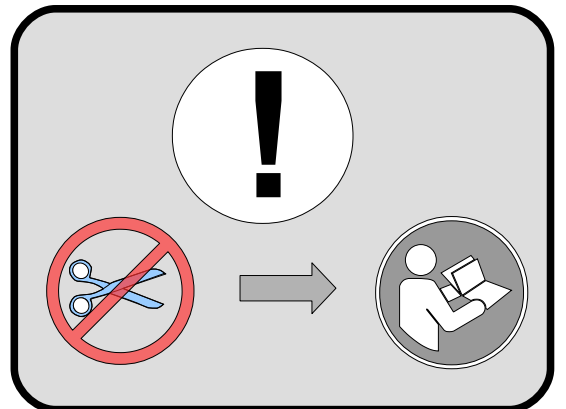
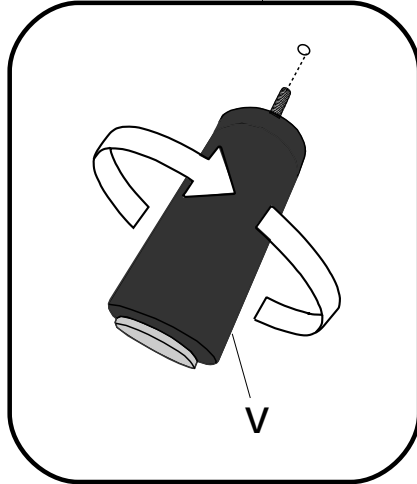
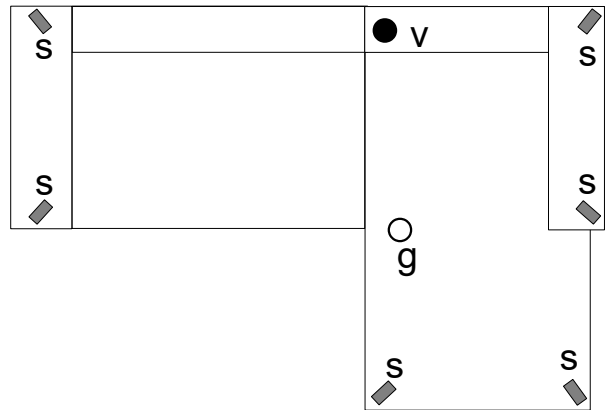
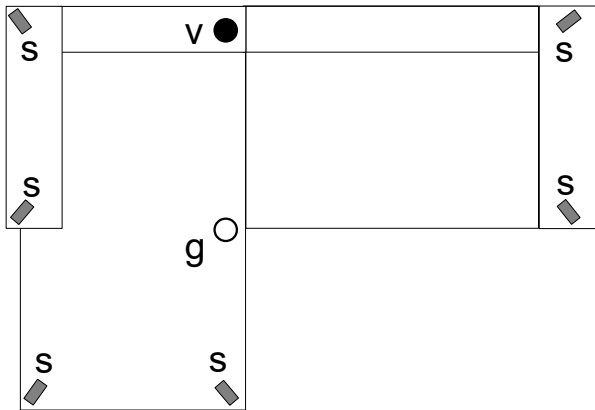
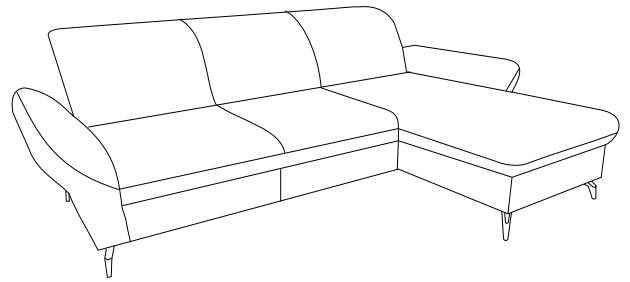
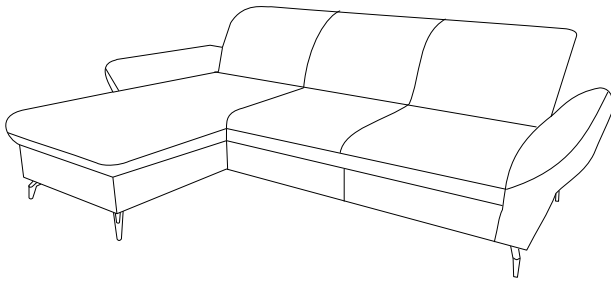

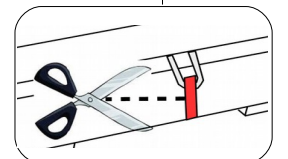
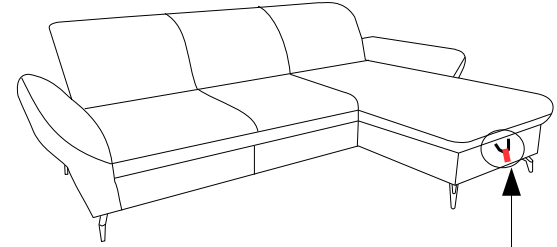
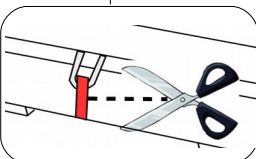
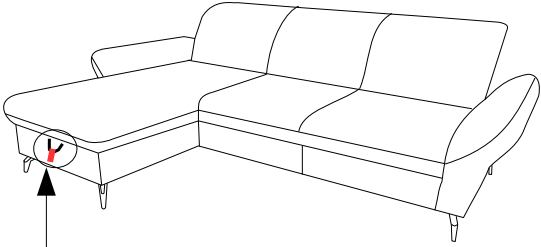
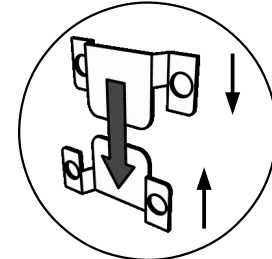
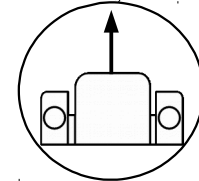
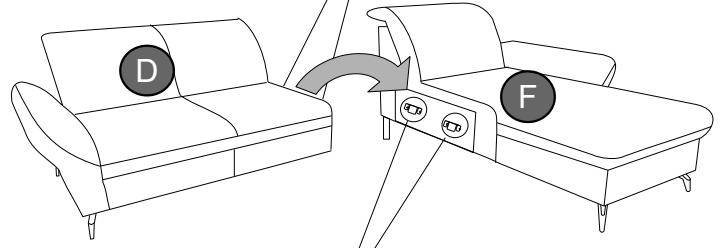
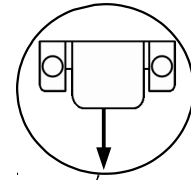
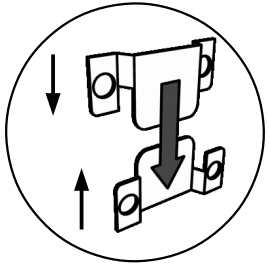
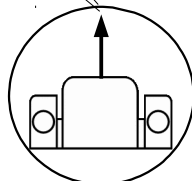
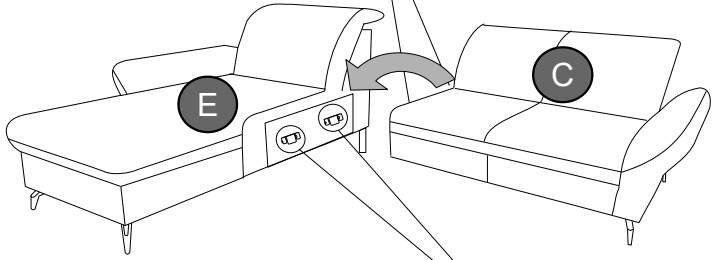
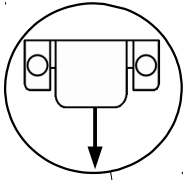
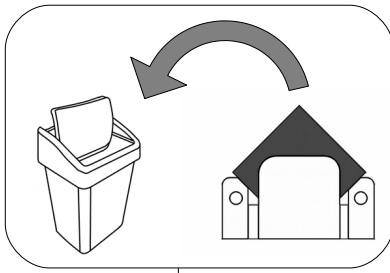

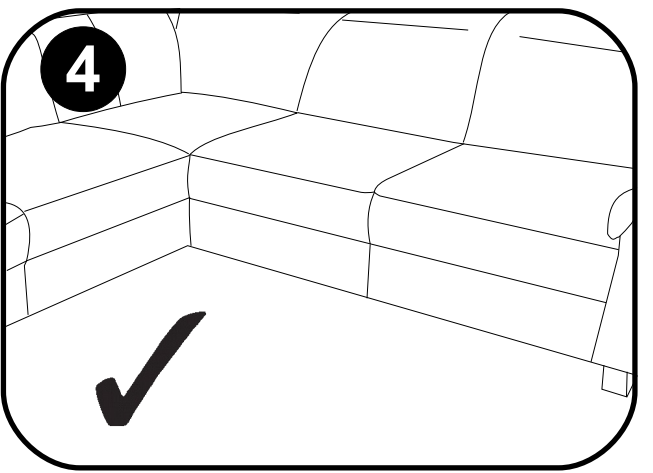
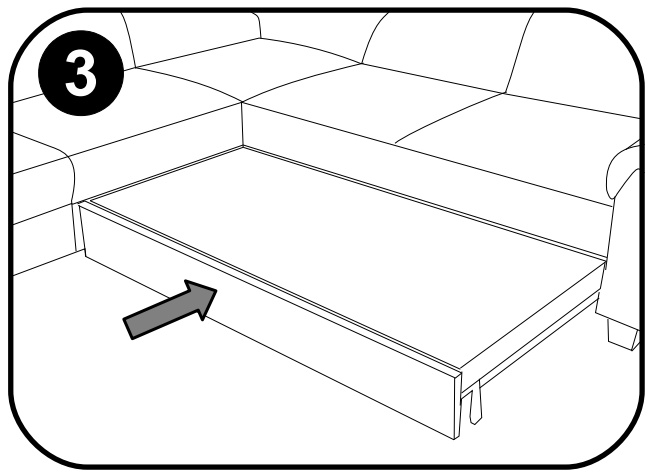
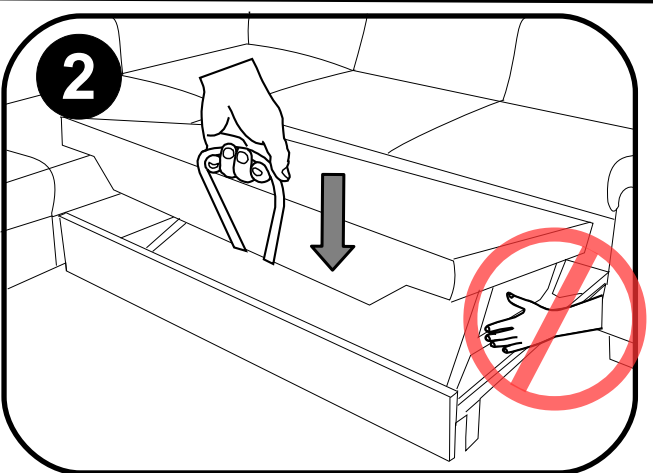
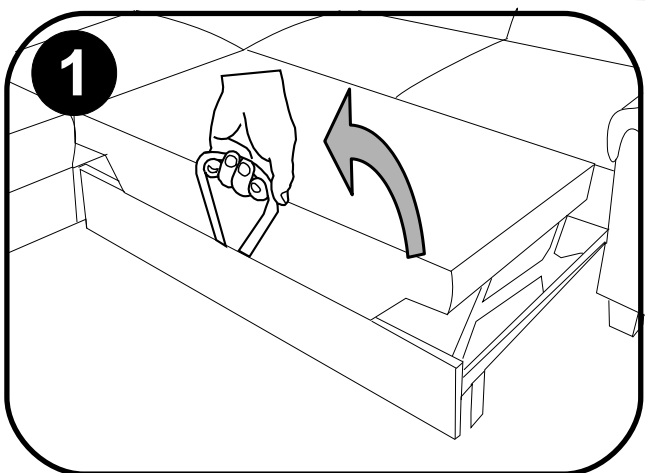
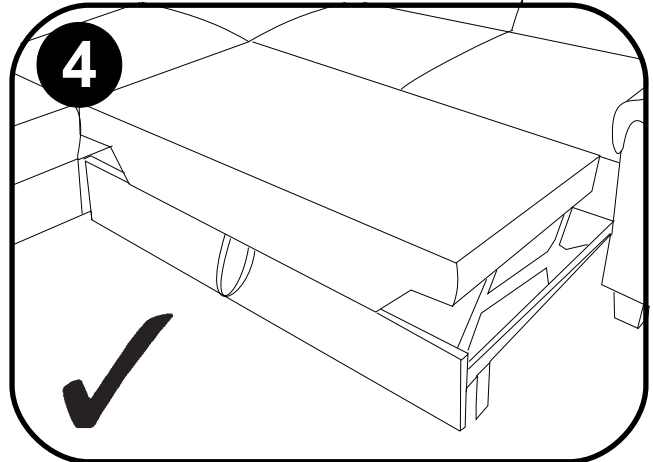
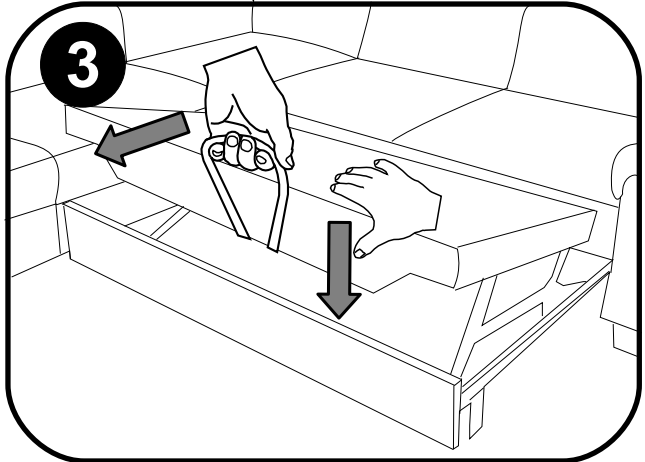
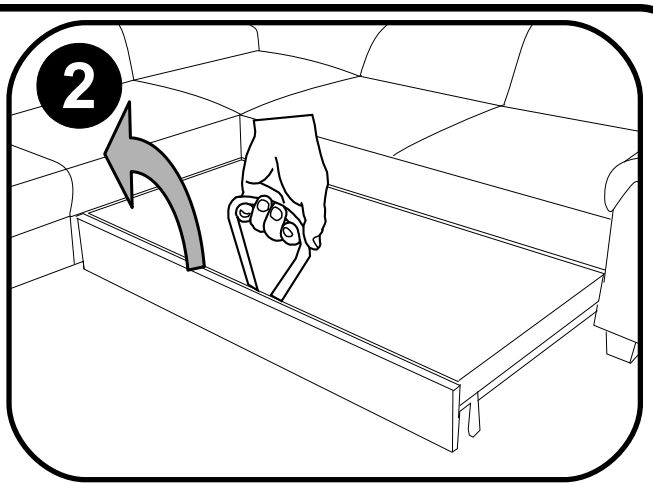
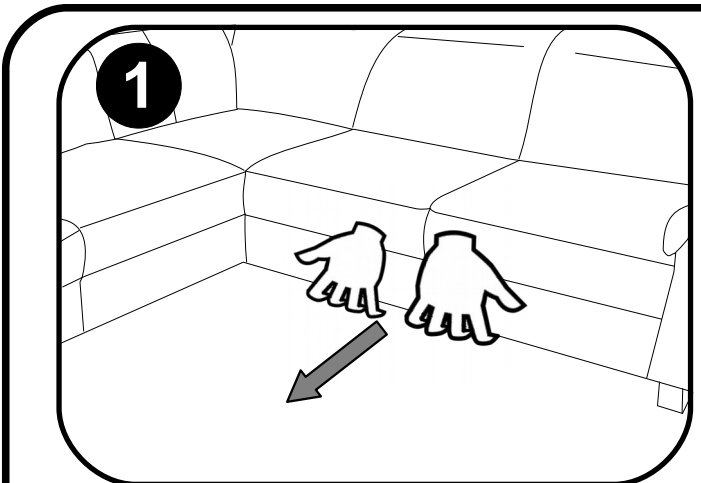
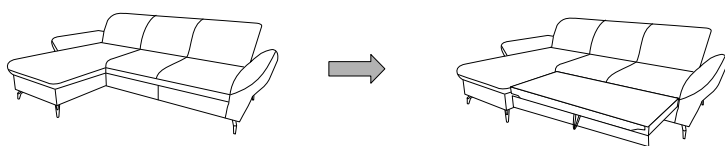

Name · Naam · Nazwa · Ísim · Название · Nume · Nome · Názov · Názov ·
 Název · Neve

LEANDRO V

Typ · Type · Tip · Тип · Tipo · Típus

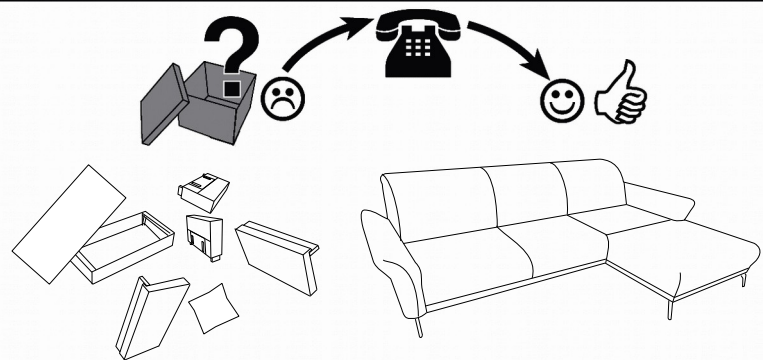
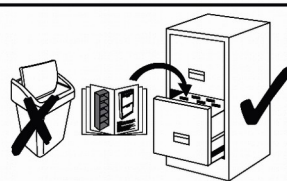

L

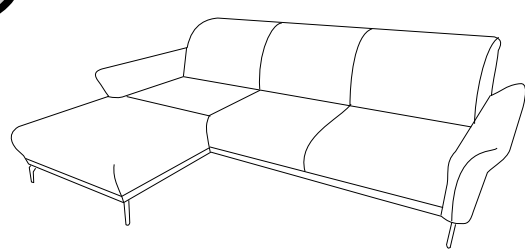

R

