

- (D) Montageanleitung**
- (NL) Handleiding voor de montage**
- (HU) Szerelési útmutató**
- (GB) Assembly instructions**
- (PL) Instrukcja montażu**

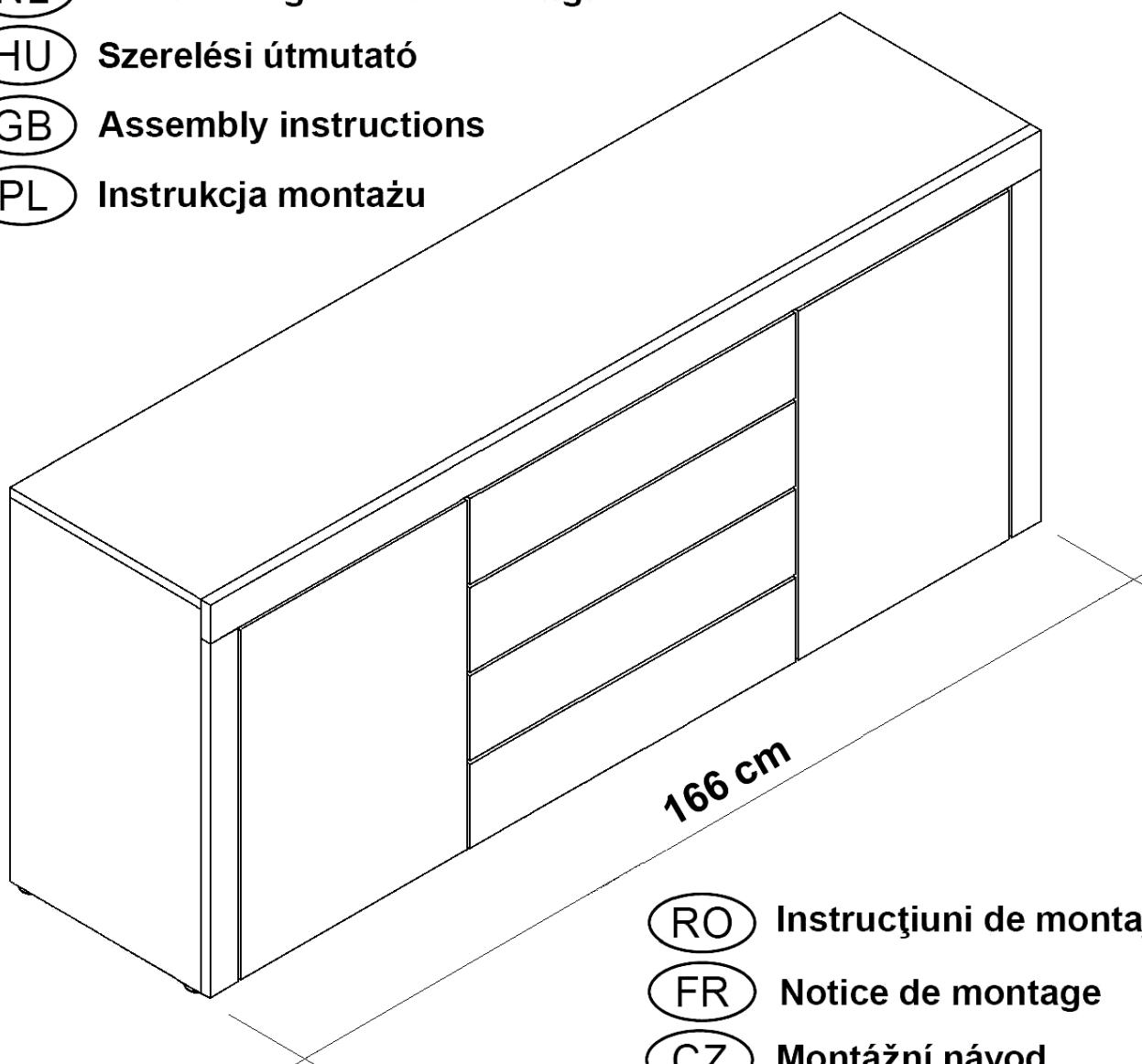

- (RO) Instrucțiuni de montaj**
- (FR) Notice de montage**
- (CZ) Montážní návod**
- (TR) Montaj talimatı**
- (IT) Istruzioni di montaggio**
- (SK) Návod na montáž**
- (RU) Инструкция по монтажу**

Service • Assistenza • Dienstverlening • Serwis
 Servis • Szerviz • Сервисная служба

Name • Nom • Nome • Naam • Nazwa • Jméno • Názov • Név • Denumire • Isim • Название	
Nr. • No. • N° • Номер • Č • Sz	
Typ • Type • Tipe • Típus • Tipo • Тип	

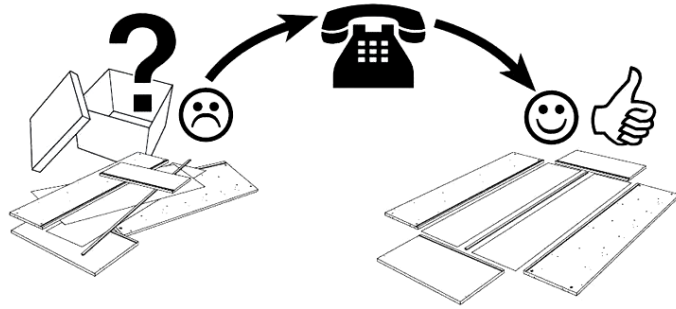
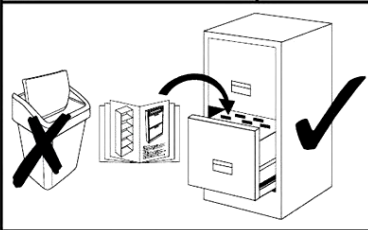

1	1x	ca. 1665 x 330 mm	13-L	4x	ca. 310 x 88 mm
2	1x	ca. 1644 x 680 mm	13-M	4x	ca. 695 x 88 mm
3	1x	ca. 1634 x 326 mm	13-R	4x	ca. 310 x 88 mm
4	1x	ca. 683 x 330 mm	14	2x	ca. 398 x 637 mm
5	1x	ca. 668 x 311 mm	15	2x	ca. 728 x 92 mm
6	1x	ca. 668 x 311 mm	16	2x	ca. 437 x 300 mm
7	1x	ca. 683 x 330 mm			
8	1x	ca. 639 x 60 mm			
9	1x	ca. 1665 x 60 mm			
10	1x	ca. 639 x 60 mm			
11	4x	ca. 737 x 156 mm			
12	4x	ca. 707 x 307 mm			

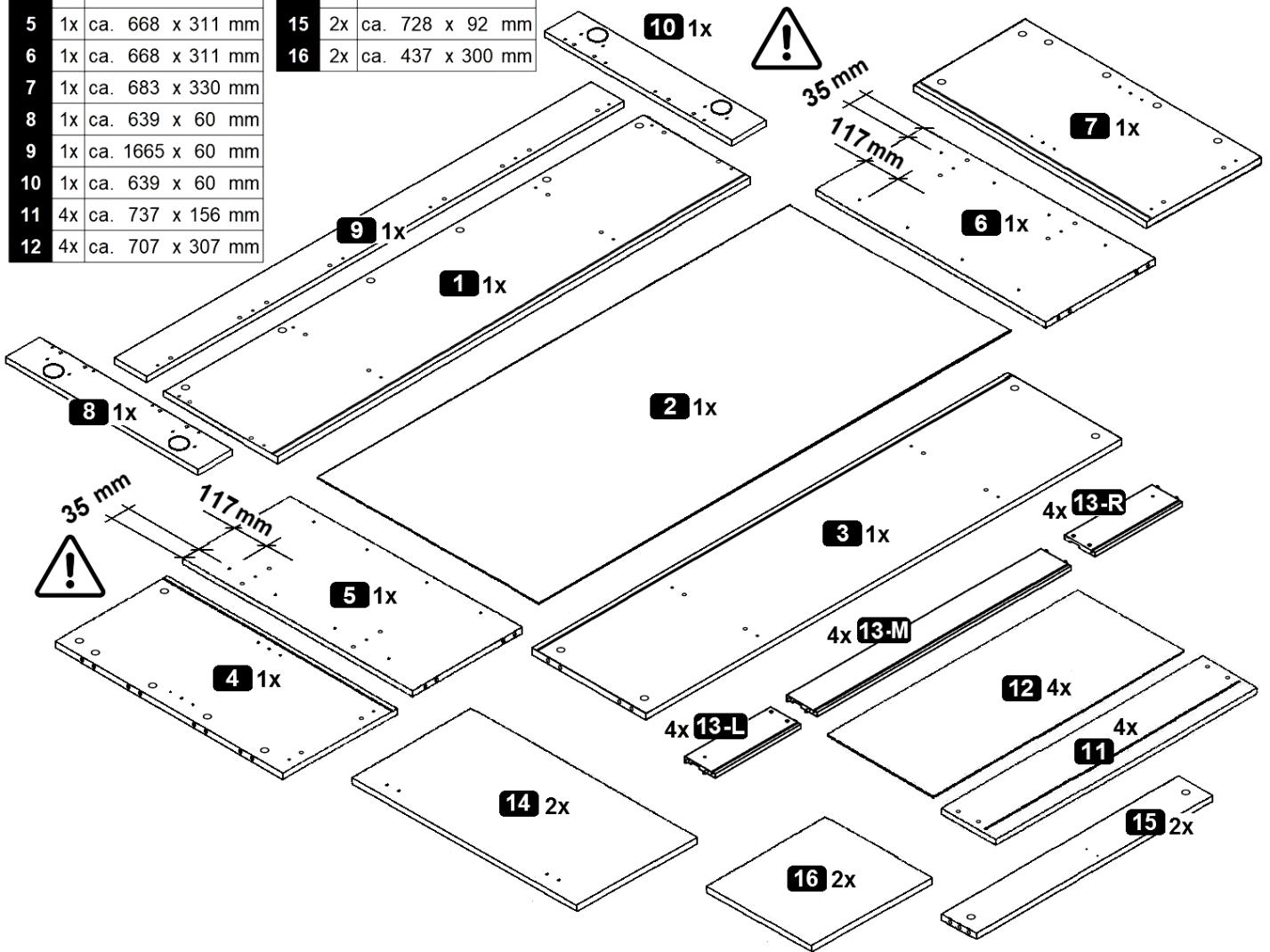

A 8,0 x 30 mm 40x	B 34x	C 34x	D 6x	E 3,5 x 9,5 mm 12x	F 8x	G 1x
H 4x	I Ø35 8x	J 4,0 x 20 mm 8x	K 2,7 x 20 mm 8x	L 17 x 310 mm 8x	M 6,3 x 13 mm 16x	N M4,0 x 9 mm 8x



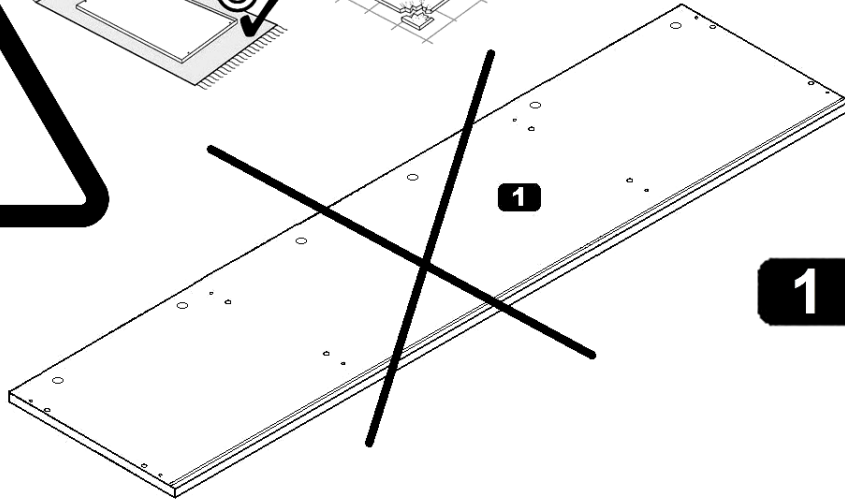
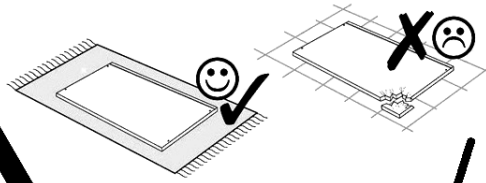

1 = X ☹️

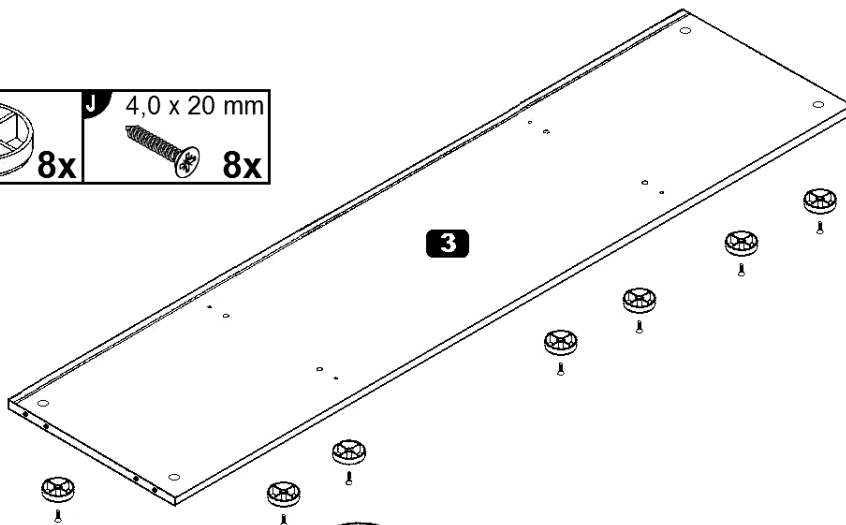
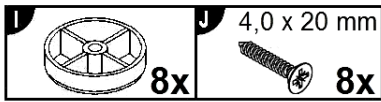

1

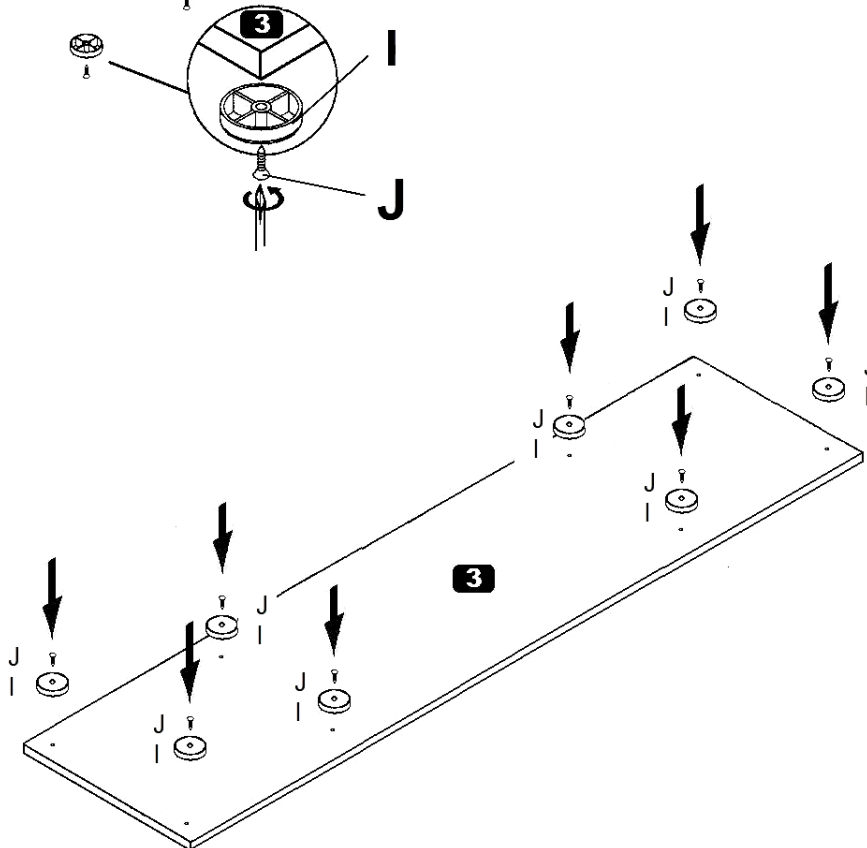

3 = 😊 ✓



2

A 8,0 x 30 mm  12x	B  18x	C  10x
--	--	--

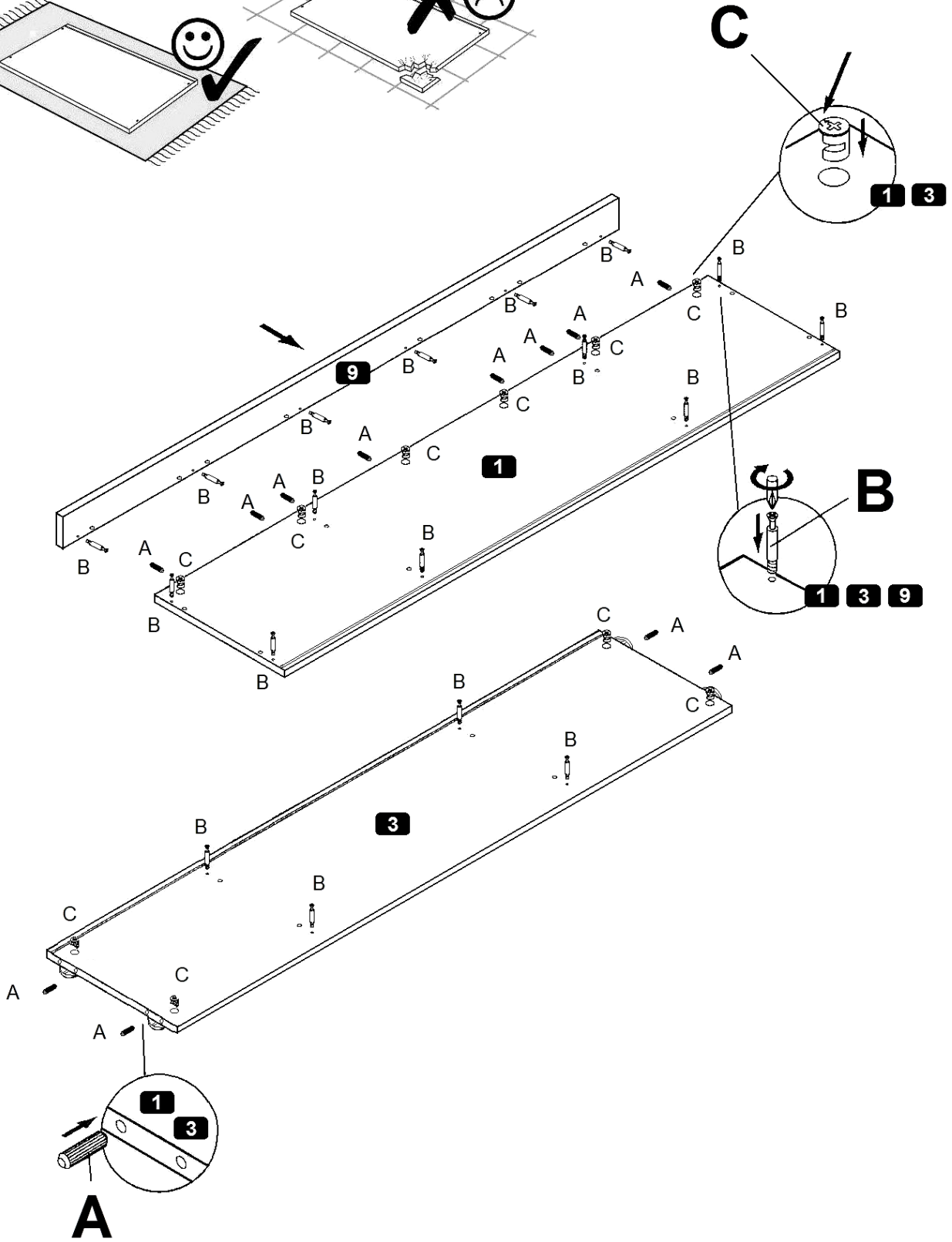
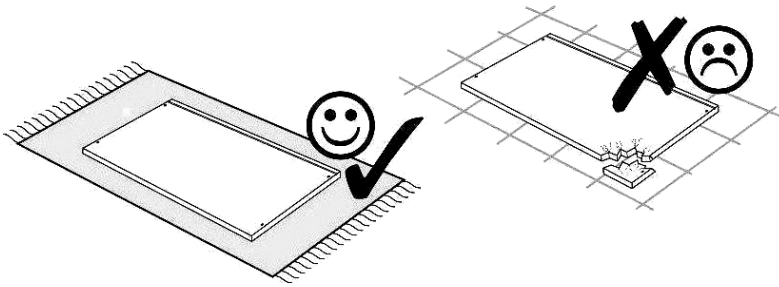
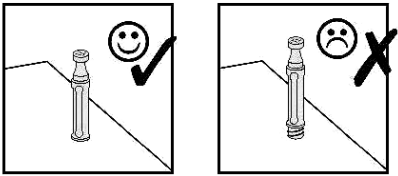

3

- A** 8,0 x 30 mm 20x
- B** 4x
- C** 16x
- D** 4x
- E** 3,5 x 9,5 mm 8x

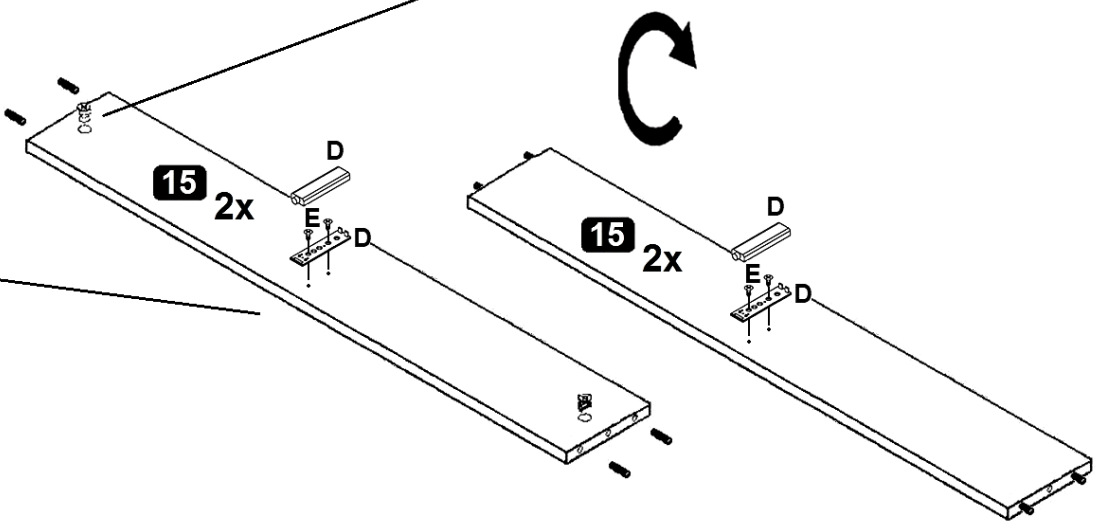
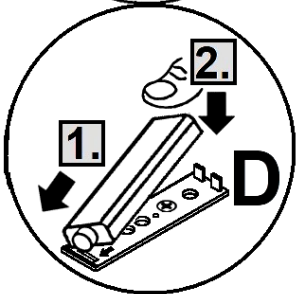
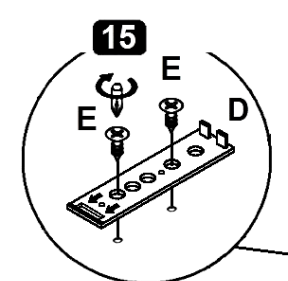
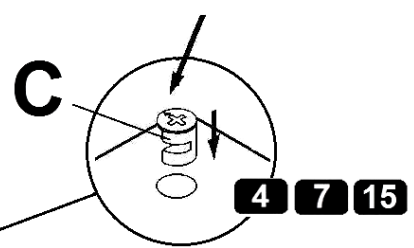
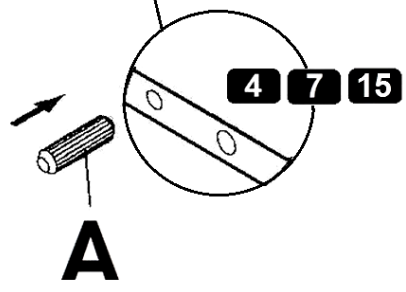
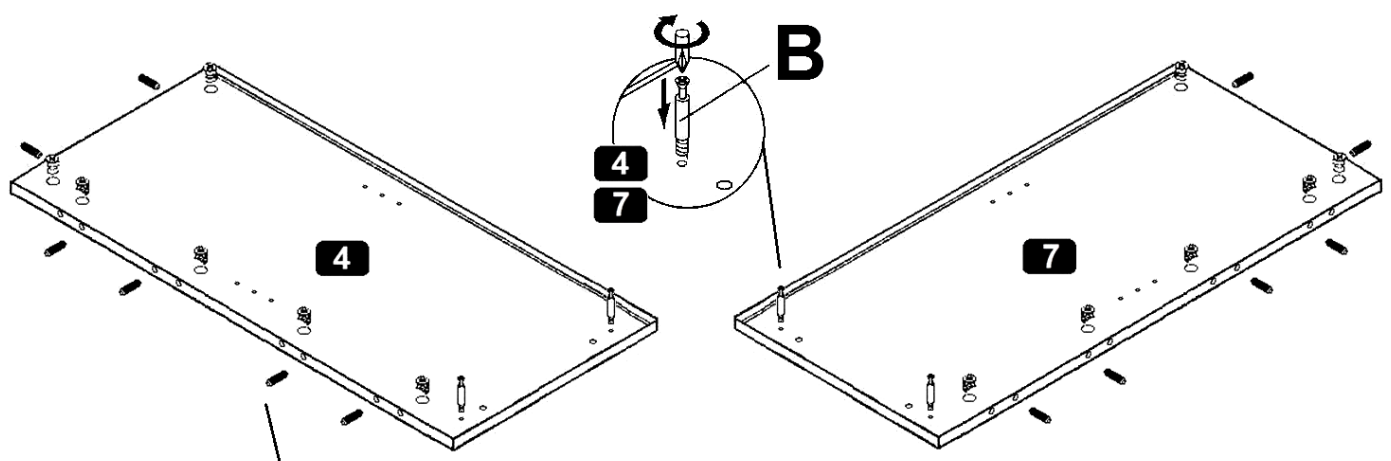
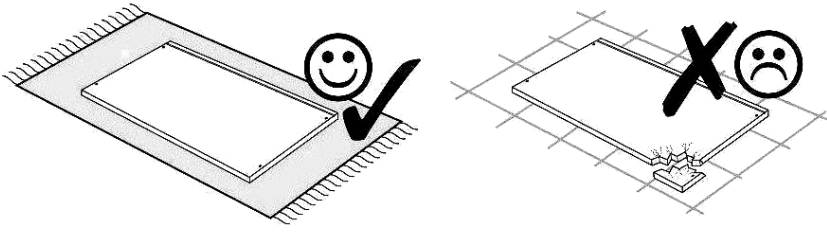
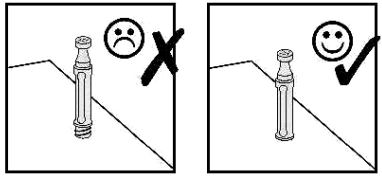

4

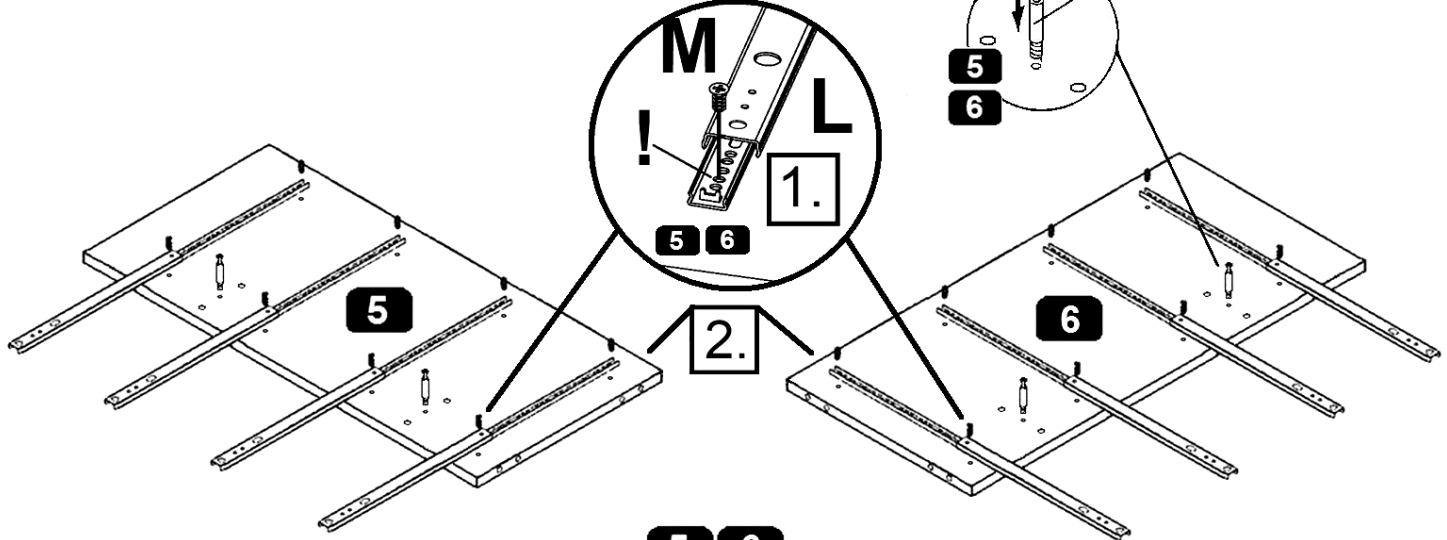
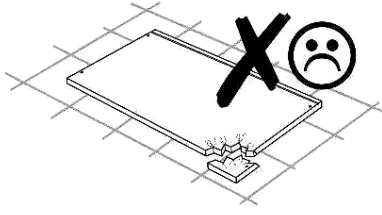
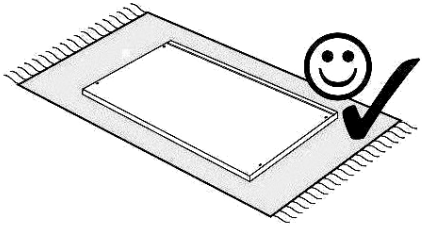
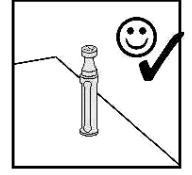
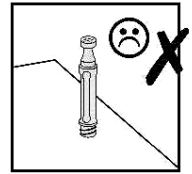
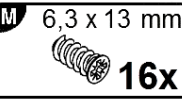
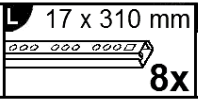
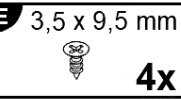
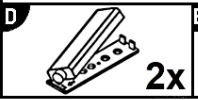
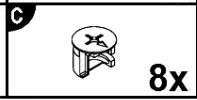
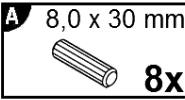
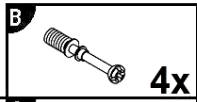

180°

180°

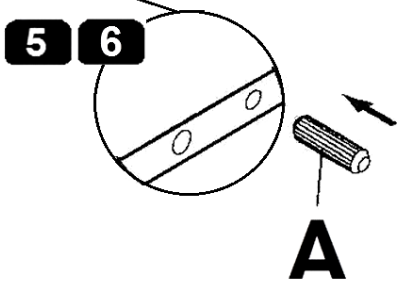
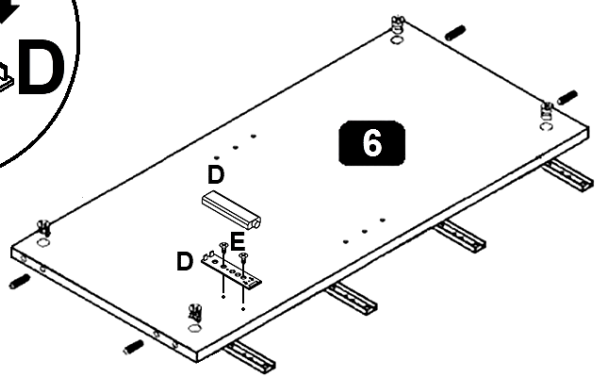
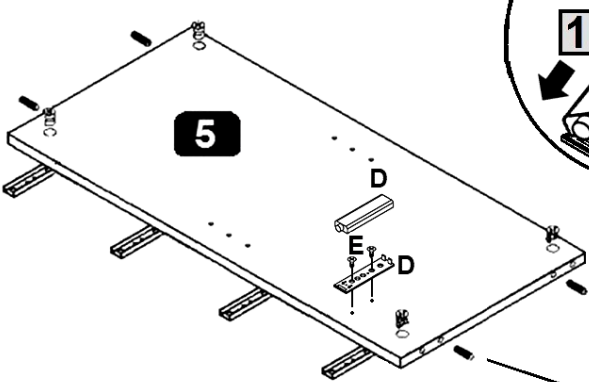
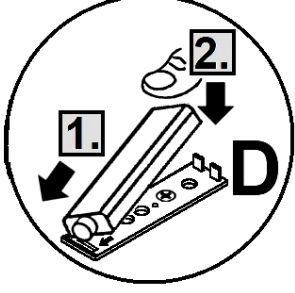
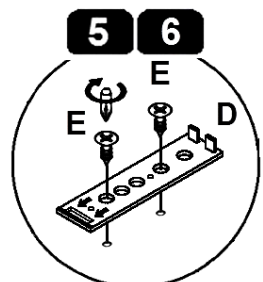

5

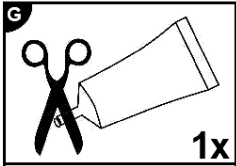

- D Leim
- GB Glue
- FR Colle
- IT Colla
- NL Lijm
- PL Klej
- CZ Lepidlo
- SK Glej
- HU Enyv
- RO Adeziv
- TR Tutkal
- RU Клей

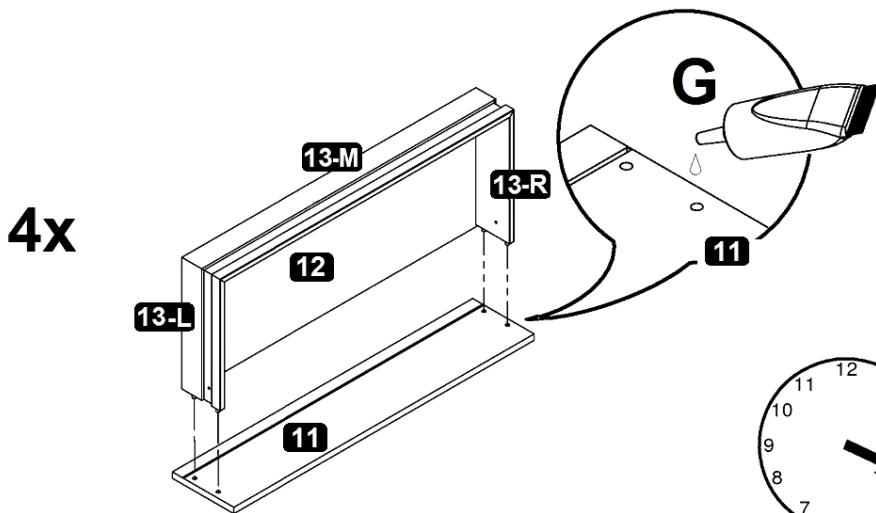
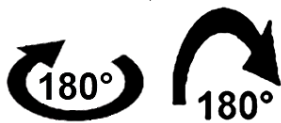
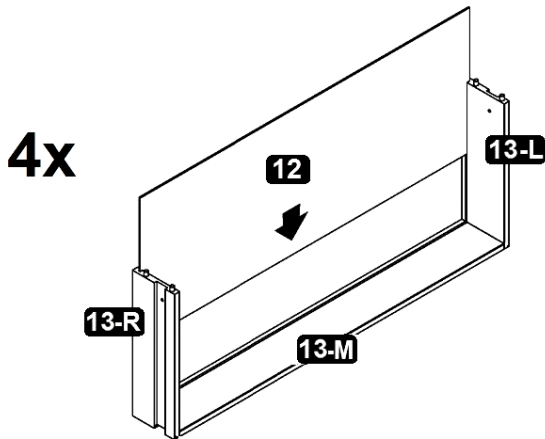
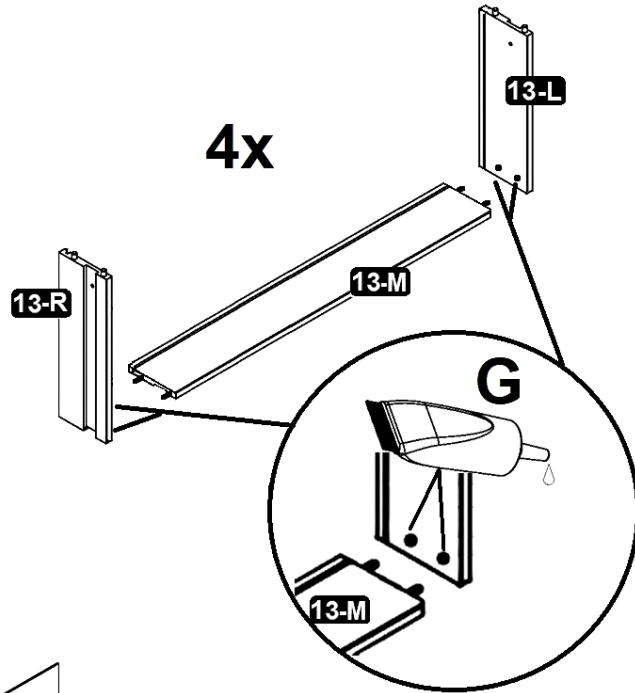
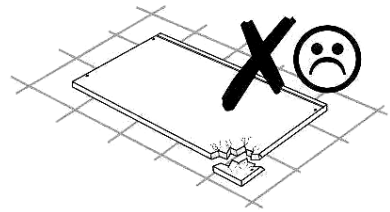
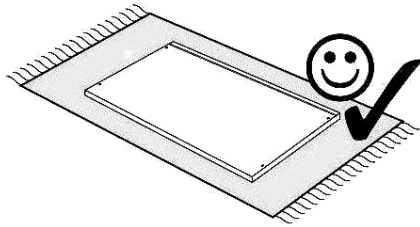

20min



6

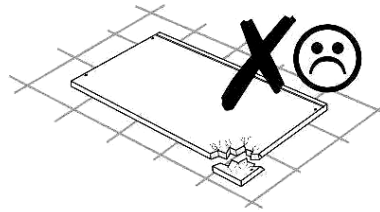
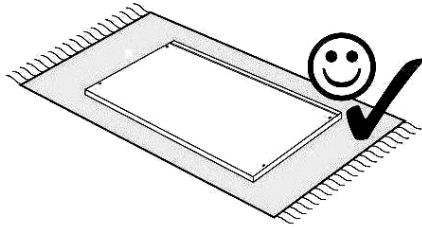
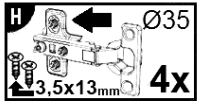

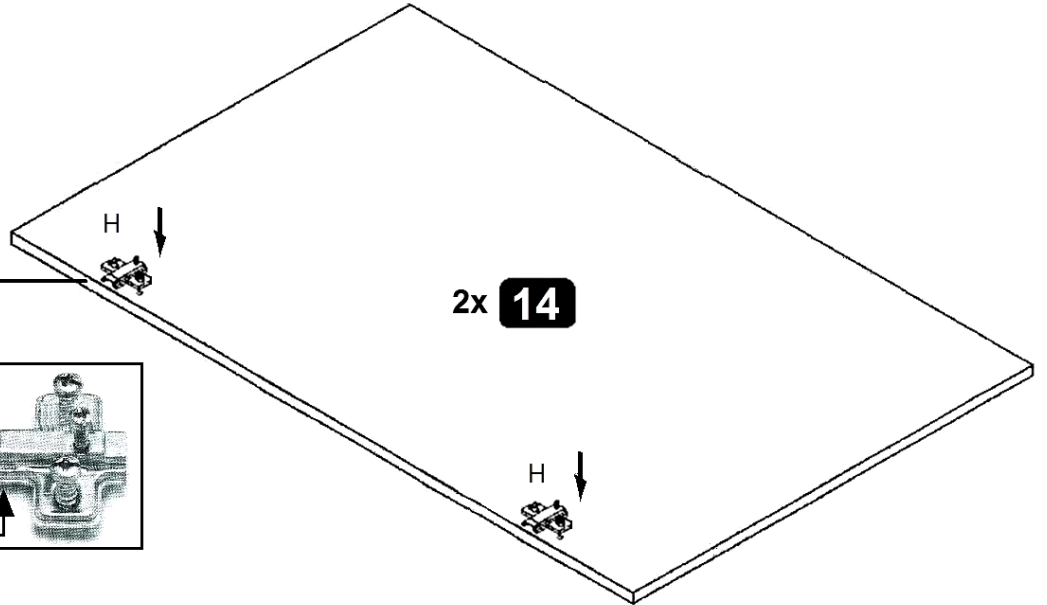
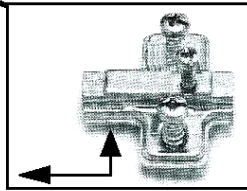
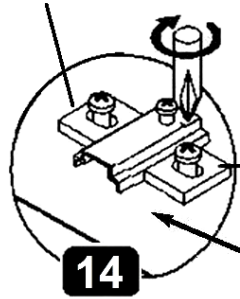

H

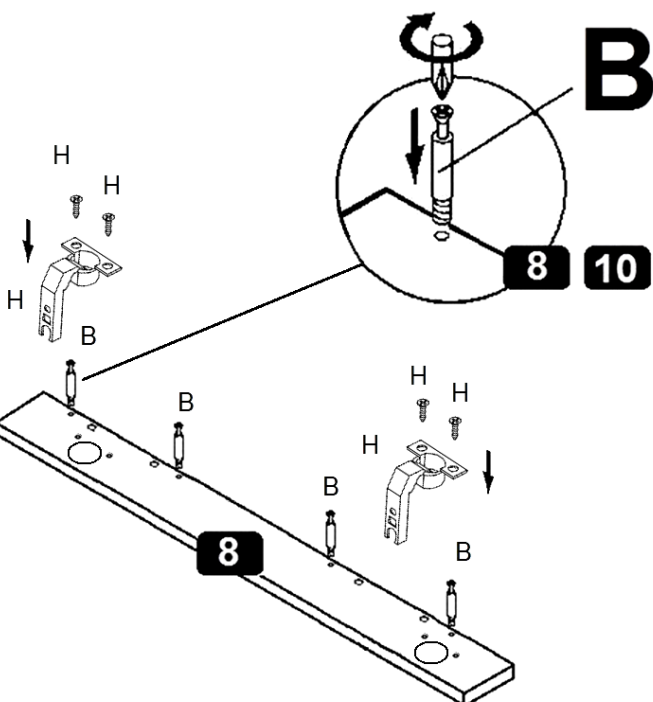
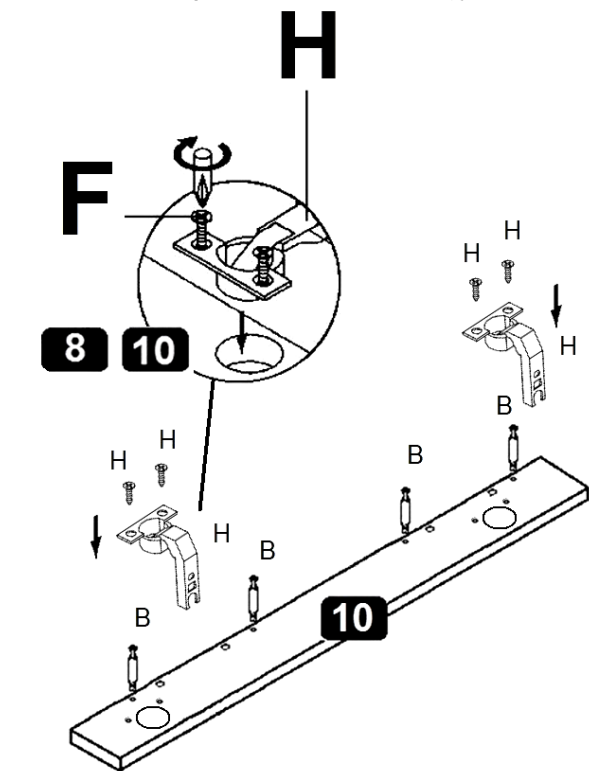
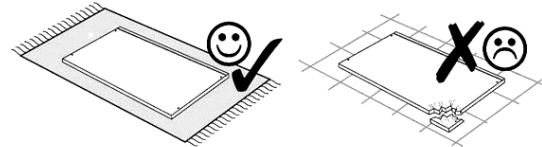
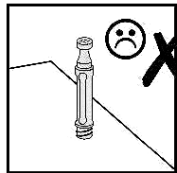
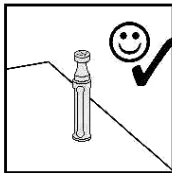
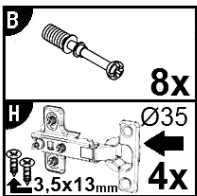

7



8

F		8x
K		8x
2,7 x 20 mm		

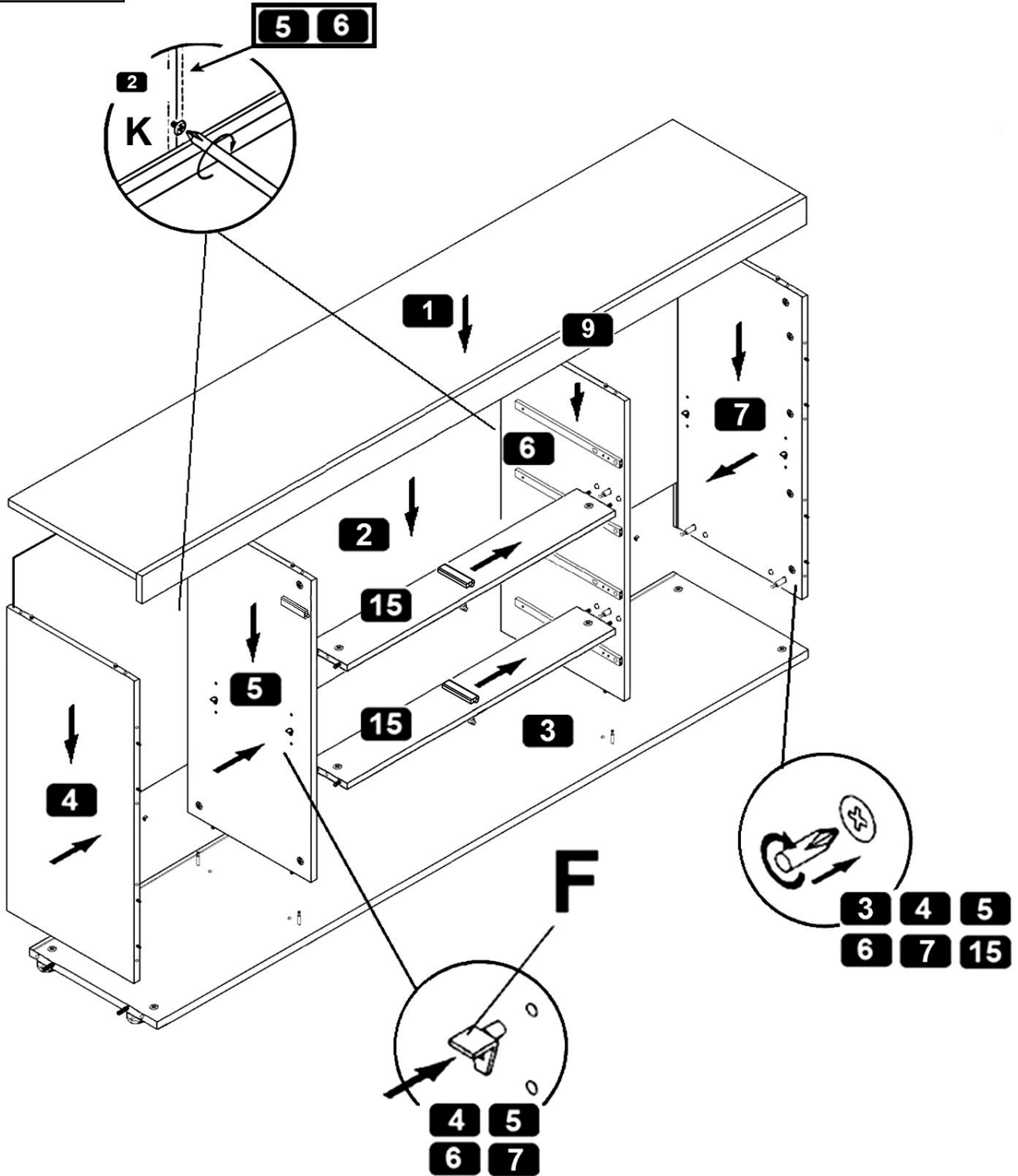

9

N M4,0 x 9 mm
8x

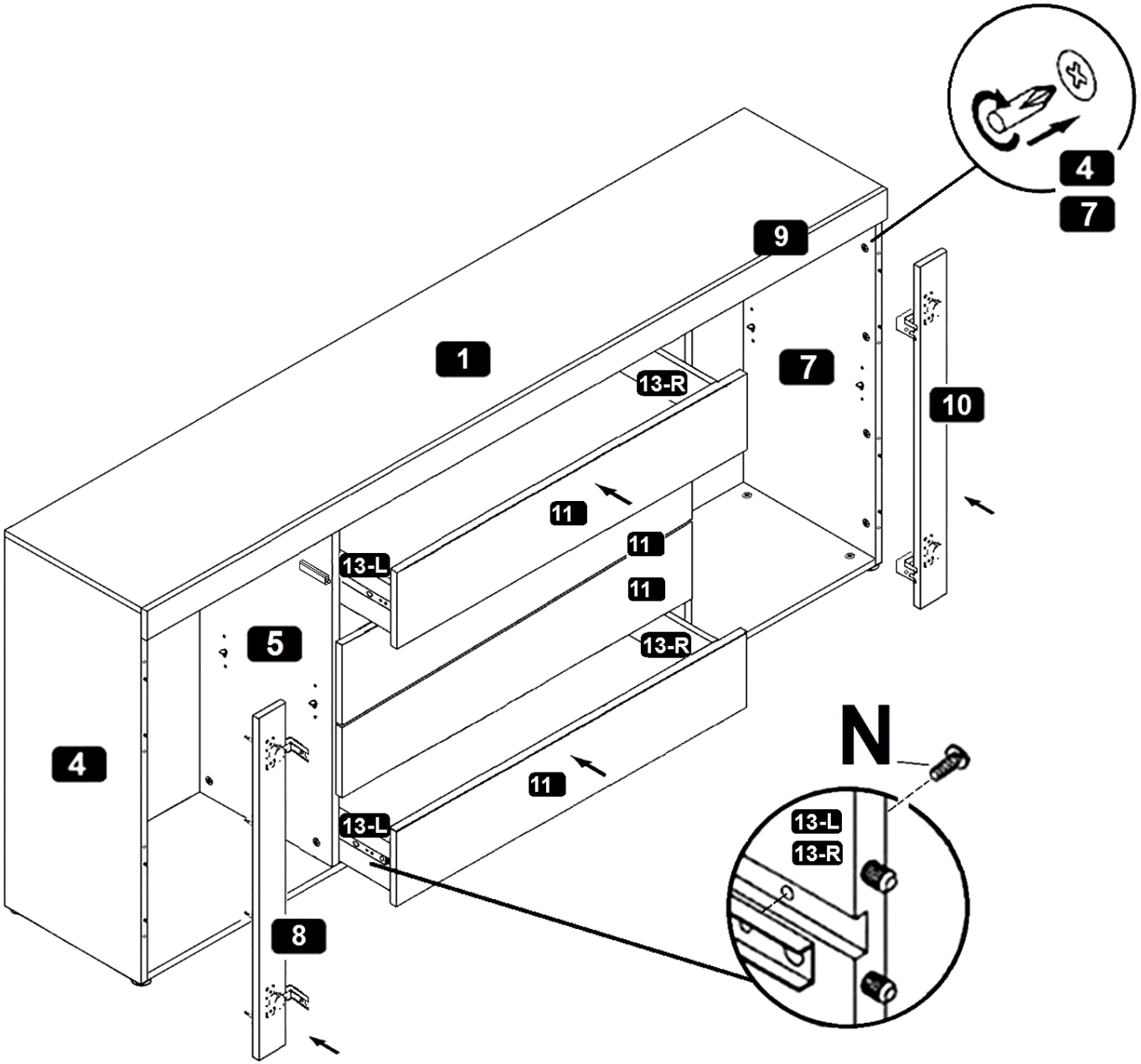

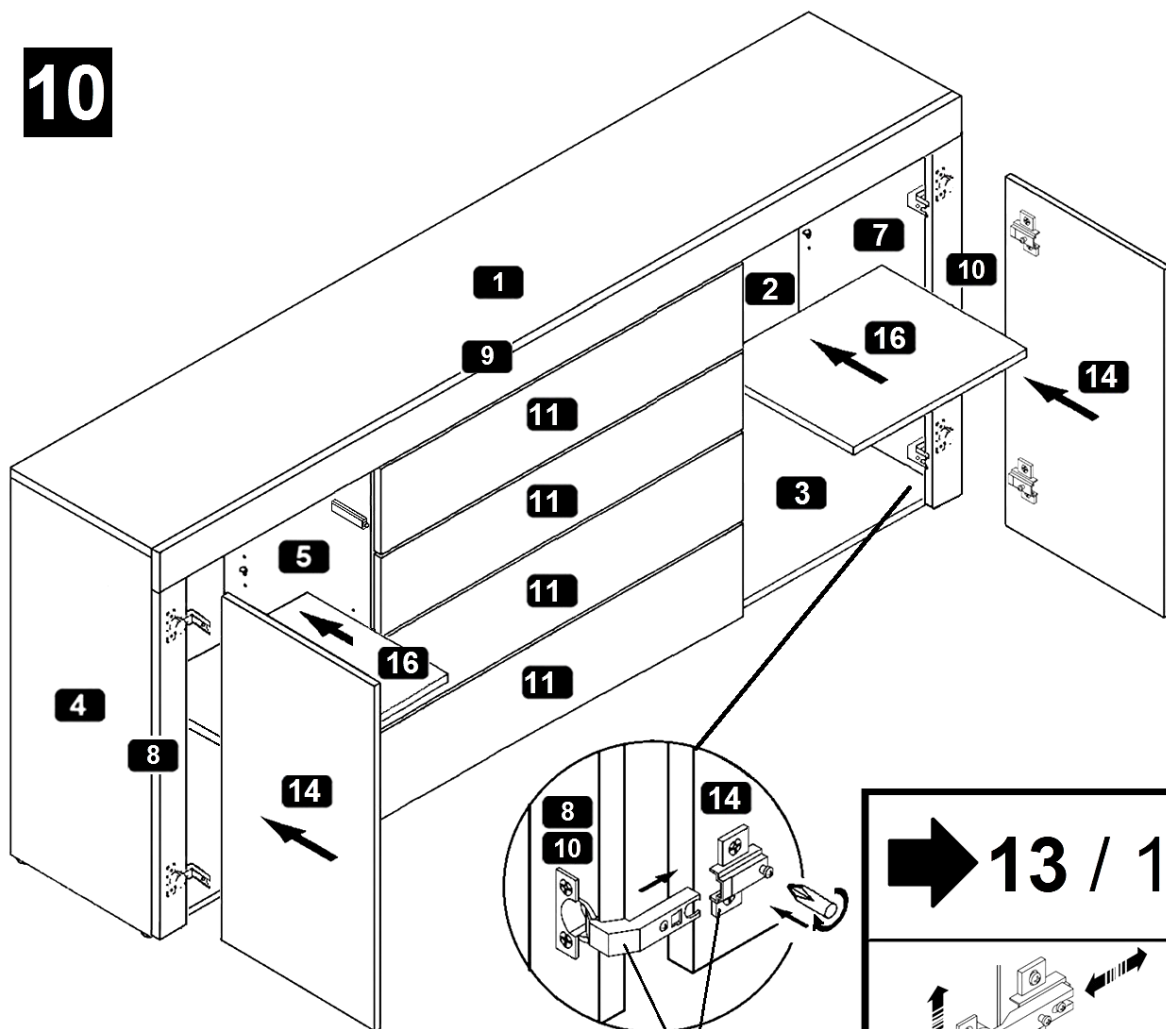

10



H

12 / 13	
<p>(D) Push-To-Open einstellen</p> <p>(GB) Adjusting the Push-To-Open</p> <p>(FR) Régler les Push-To-Open</p> <p>(IT) Sistemare Push-To-Open</p> <p>(NL) Push-To-Open instellen</p> <p>(PL) Nastawić Push-To-Open</p> <p>(CZ) Vyrovnajte Push-To-Open</p> <p>(RO) Nastavenie Push-To-Open</p> <p>(HU) Állítsa be az Push-To-Open</p> <p>(SK) Reglare Push-To-Open</p> <p>(TR) Push-To-Open ayarlanması</p> <p>(RU) Регулировка Push-To-Open</p>	

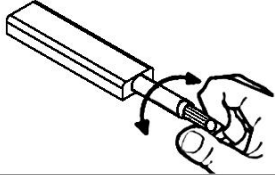
13 / 13	
<p>(D) Türen einstellen (Scharniere justieren)</p> <p>(GB) Adjusting the doors (adjusting the hinges)</p> <p>(FR) Régler les portes (ajuster les charnières)</p> <p>(IT) Sistemare le porte (regolare le cerniere)</p> <p>(NL) Deuren instellen (scharnieren afstellen)</p> <p>(PL) Nastawić drzwi (wyregulować zawiasy)</p> <p>(CZ) Vyrovnajte dvířka (seřid'te závěsy)</p> <p>(RO) Nastavenie dverí (nastavenie závesov)</p> <p>(HU) Állítsa be az ajtókat (állítsa be a zsanérokat)</p> <p>(SK) Reglare uši (ajustare balamale)</p> <p>(TR) Kapıların ayarlanması (menteşelerin seviye ayarı)</p> <p>(RU) Регулировка дверей (регулировка шарнира)</p>	

  	
<p>(D) Push-To-Open einstellen</p> <p>(GB) Adjusting the Push-To-Open</p> <p>(FR) Régler les Push-To-Open</p> <p>(IT) Sistemare Push-To-Open</p> <p>(NL) Push-To-Open instellen</p> <p>(PL) Nastawić Push-To-Open</p>	<p>(CZ) Vyrovnajte Push-To-Open</p> <p>(RO) Nastavenie Push-To-Open</p> <p>(HU) Állítsa be az Push-To-Open</p> <p>(SK) Reglare Push-To-Open</p> <p>(TR) Push-To-Open ayarlanması</p> <p>(RU) Регулировка Push-To-Open</p>

1.

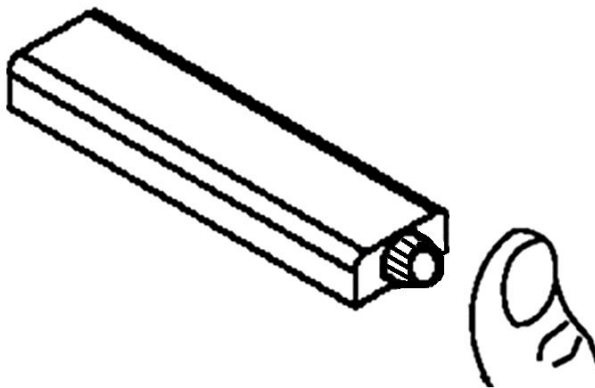

2.

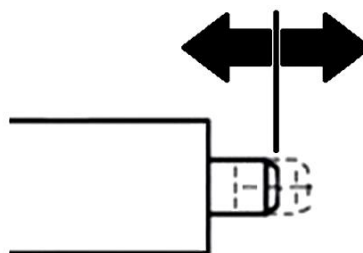
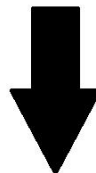
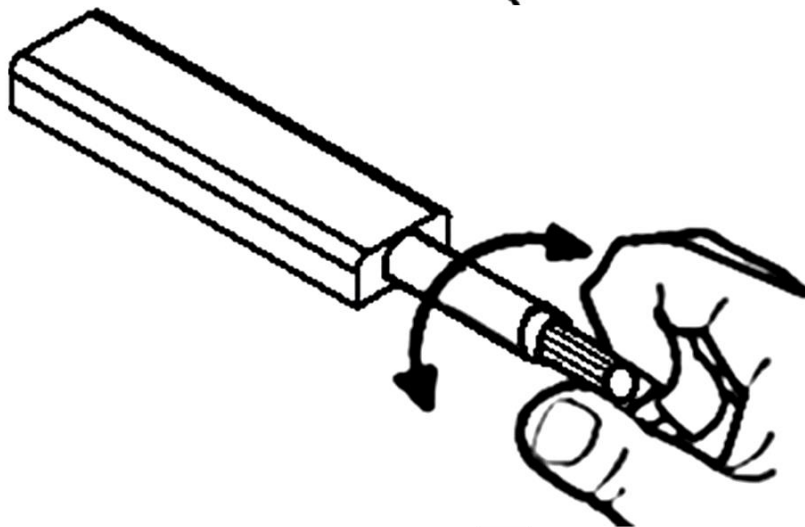

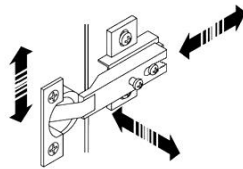
12

(D) Türen einstellen
(Scharniere justieren)

(GB) Adjusting the doors
(adjusting the hinges)

(FR) Régler les portes
(ajuster les charnières)

(IT) Sistemare le porte
(regolare le cerniere)

(NL) Deuren instellen
(scharnieren afstellen)

(PL) Nastawić drzwi
(wyregulować zawiasy)

(CZ) Vyrovnajte dvířka
(seřid'te závěsy)

(RO) Nastavenie dverí
(nastavenie závesov)

(HU) Állítsa be az ajtókat
(állítsa be a zsanérokát)

(SK) Reglare uși
(ajustare balamale)

(TR) Kapıların ayarlanması
(menteşelerin seviye ayarı)

(RU) Регулировка дверей
(регулировка шарнира)

