

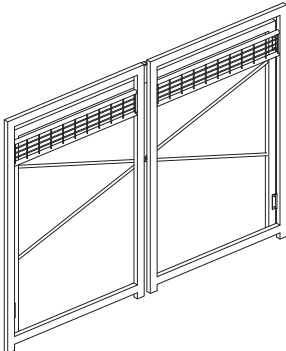

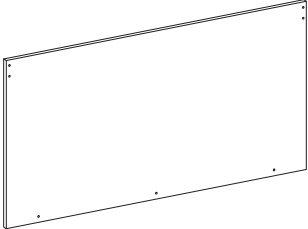



**INSTRUCTION MANUAL/BEDIENUNSANLEITUNG/NOTICE D'UTILISATION/
MANUAL DE INSTRUCCIONES DE USO/MANUALE DI ISTRUZIONI
PARTS LIST/STÜCKLISTE/PARTS LIST/LISTA DE PIEZAS/LISTA DEI PEZZI**

<p>A</p>  <p>1pc</p>	<p>B</p>  <p>1pc</p>	<p>C</p>  <p>1pc</p>			
<p>D</p>  <p>8pcs</p>	<p>E</p>  <p>2pcs</p>	<p>F</p>  <p>4pcs</p>	<p>G</p>  <p>M5×10 4pcs</p>	<p>H</p>  <p>M6×33 3pcs</p>	<p>I</p>  <p>S4 1pc</p>

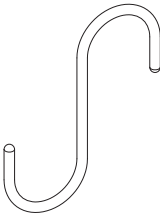
ASSEMBLY/MONTAGE/ASSEMBLAGE/MONTAJE/ASSEMBLAGGIO

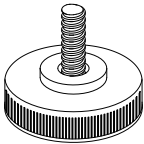

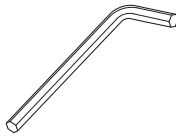
Warning! Tight all the screws to 60% first then tight to 100%.
Warnung! Während der Montage alle Schrauben zuerst 60% anziehen, dann zu 100%.
Attention! Serrez toutes les vis à 60% d'abord puis serrez à 100%.
Atención! Primero apriete los tornillos al 60% y después al 100%.
Avvertimento! Stringere le viti dapprima al 60% e successivamente completamente al 100%.

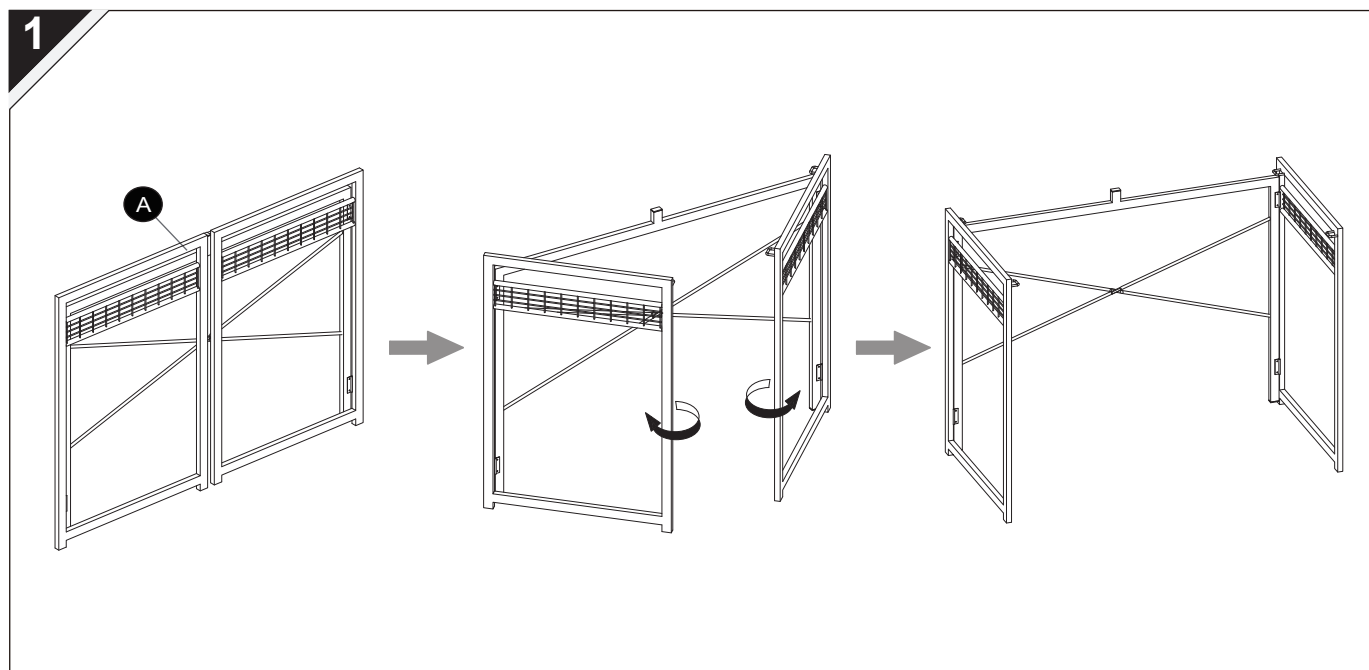

**RETAIN FOR FUTURE REFERENCE
FÜR KÜNFTIGE VERWENDUNG AUFBEWAHREN
A CONSERVER POUR UNE UTILISATION FUTURE
CONSERVAR PARA SER LEÍDO POR CADA NUEVO USUARIO,
ANTES DE UTILIZAR EL ARTÍCULO POR PRIMERA VEZ
CONSERVARE PER CONSULTAZIONI FUTURE**





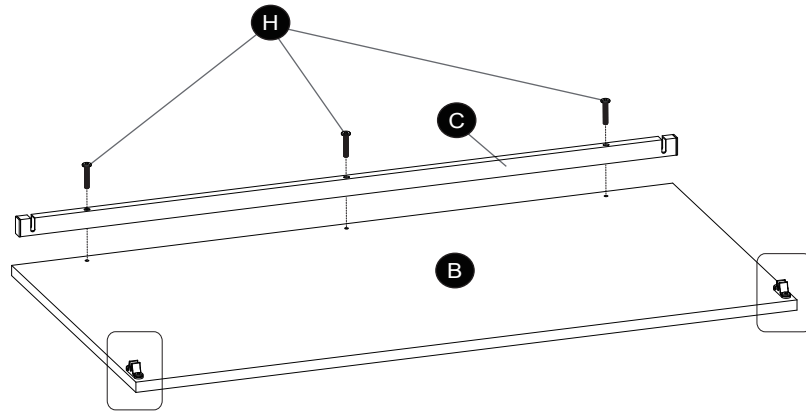
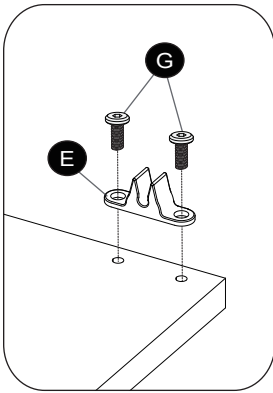

Warning!
Warnung!
Attention !
Atención!
Avvertimento!

Tight all the screws to 60% first then tight to 100%.
Während der Montage alle Schrauben zuerst 60% anziehen, dann zu 100%.
Serrez toutes les vis à 60% d'abord puis serrez à 100%.
Primero apriete los tornillos al 60% y después al 100%.
Stringere le viti dapprima al 60% e successivamente completamente al 100%.

2



-  **G** M5x10 x4
-  **H** M6x33 x3
-  **E** x2
-  **I** S4 x1

3

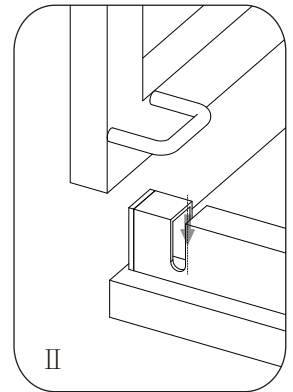
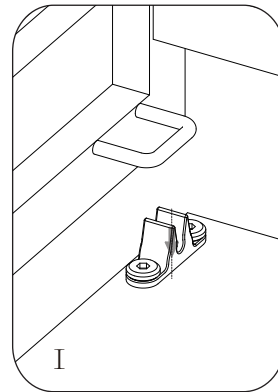
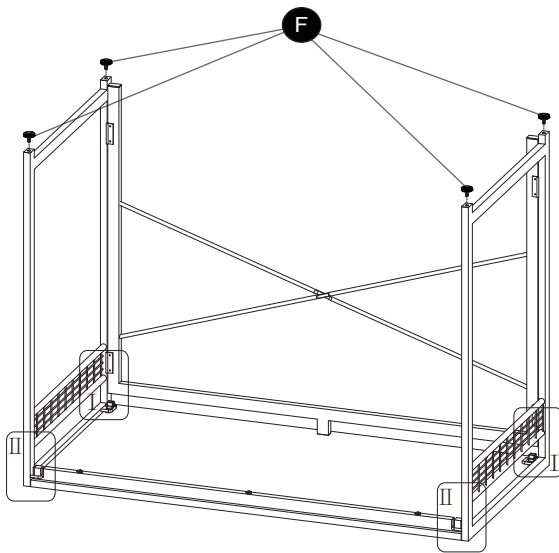

-  **F** x4

4

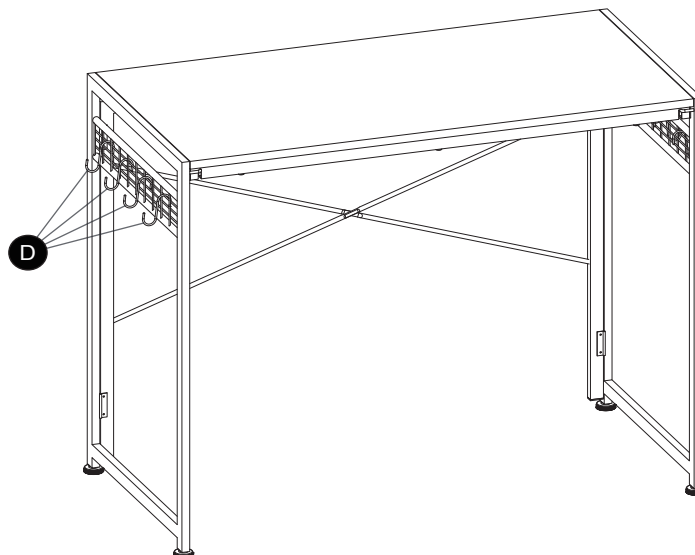

-  **D** x8