

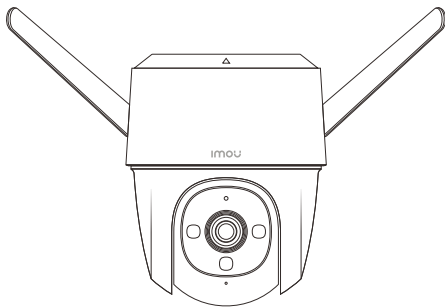

Quick Start Guide

Cruiser



EN

DE

ES

FR

IT

NL

PT

AR

Welcome

Thank you for choosing IMOU.

We are devoted to providing you easy smart home products.
If you have problems using the product, please contact
our service team before returning your product.

Our service mail: service.global@imoulife.com

Frequently asked questions can be found at
imoulife.com/support/help



Package content



Camera x1



Quick Start Guide x1



Power Adapter x1



Screw Package x1



Mounting
Template x1



Mounting Bracket x1



Waterproof
Connector x1

Camera introduction

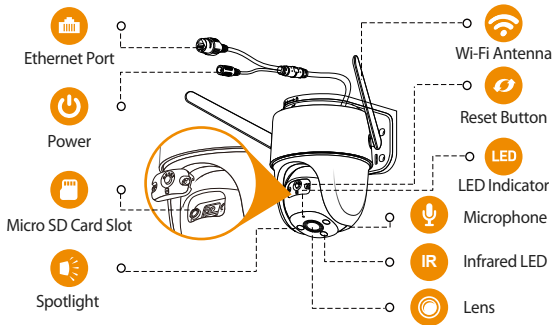

Note: Disconnect the camera from the power before installation or taking out its SD card.

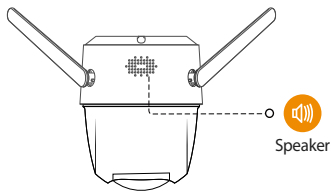

- Note:**
1. Press and hold the reset button for 10 s to reset the camera.
 2. Double-press the reset button to enable camera's hotspot.

See the table below for definitions of camera's LED behaviors.

LED Indicator Status	Device Status
off	<ul style="list-style-type: none"> ● Power off/LED turned off ● Rebooting after reset
Solid red	<ul style="list-style-type: none"> ● Booting ● Device malfunction
Flashing red	<ul style="list-style-type: none"> ● Network connection failed ● Pairing failed
Flashing green	<ul style="list-style-type: none"> ● Ready for network configuration ● Ready to pair
Solid green	<ul style="list-style-type: none"> ● Operating properly
Flashing green and red alternately	<ul style="list-style-type: none"> ● Updating firmware

1 Download the APP

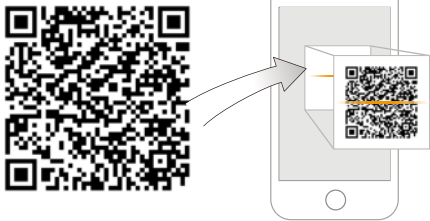

Imou Life



i Tips

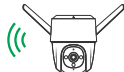

To ensure the best possible wireless performance, please make sure there are no obstacles and electromagnetic interference between the camera and router.

2 Add device to the APP

EN

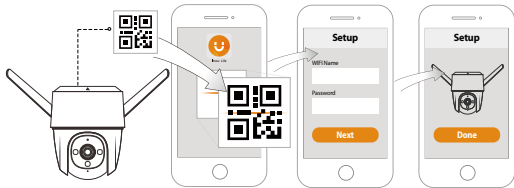



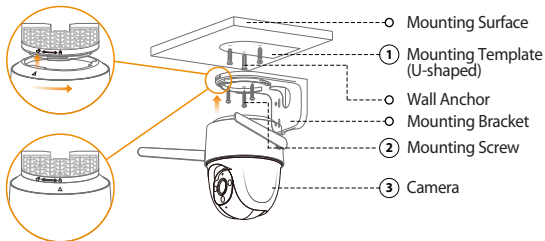

3 Installing Camera

 **Note:** Make sure that the mounting surface is strong enough to hold at least three times the weight of the camera and the bracket.



Ceiling Mount

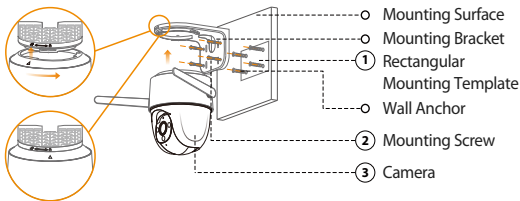

- ① Peel off the U-shaped mounting template and stick it to the desired installation area.
- ② Drill holes into the mounting surface as the mounting template marks and then insert wall anchors as needed.
- ③ Secure the mounting bracket to the surface with included mounting screws.
- ④ Align  on the top of the camera with  on the bracket, then fit the two parts together.
- ⑤ Rotate the camera counterclockwise until it is locked. Make sure  align with .
- ⑥ Power on the camera and then adjust its angle properly.

Wall Mount





- ① Peel off the rectangular mounting template and stick it to the desired installation area.
- ② Drill holes into the mounting surface as the mounting template marks and then insert wall anchors as needed.
- ③ Secure the mounting bracket to the surface with included mounting screws.
- ④ Align  on the top of the camera with  on the bracket, then fit the two parts together.

- ⑤ Rotate the camera counterclockwise until it is locked. Make sure \triangle align with .
- ⑥ Power on the camera and then adjust its angle properly.

Pole Mount

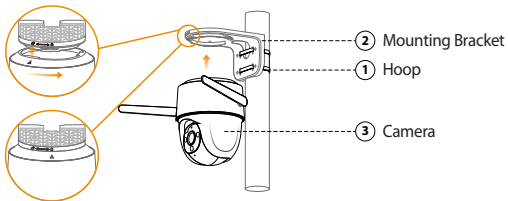
-  **Note:** 1. Make sure that the pole is strong enough to hold at least three times the weight of the camera and the bracket.
2. The hoops are not provided. Please prepare them in advance.



- ① Thread the hoop through the mounting holes on the bracket, then attach the bracket to the pole.
- ② Align \triangle on the top of the camera with  on the bracket, then fit the two parts together.
- ③ Rotate the camera counterclockwise until it is locked. Make sure \triangle align with .
- ④ Power on the camera and then adjust its angle properly.

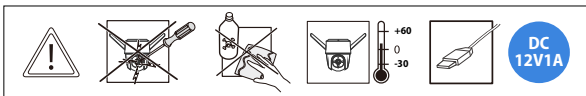

Question	Answer
The device cannot boot up or work as expected?	<ul style="list-style-type: none"> • Check the LED indicator status. If the light is not in green, press and hold the reset button for 10 s to reset the camera.
How to connect the camera to another Wi-Fi network?	<ul style="list-style-type: none"> • If the camera is online, select Device Details > Network Config to change the Wi-Fi connection on the app. • If the camera is offline, reset the camera, and then configure the camera again.
Connection takes too long?	<ul style="list-style-type: none"> • Check if the distance between the camera and the router, and that between the camera and the smart phone is both within 5 m (16.4 ft) during the connection. • Check the Wi-Fi configuration of the router: Select the channel to auto, and the mode to 11bgn mixed.
When the micro SD card is full, how is the recorded video saved?	<ul style="list-style-type: none"> • When the micro SD card is full, the system will overwrite the previous recorded videos. Save the important information in time.
Where are the recorded videos saved?	<ul style="list-style-type: none"> • If you have activated the cloud storage and installed a micro SD card, \ the recordings will be both saved to the card and cloud. If the cloud storage is deactivated, the recordings are saved to the SD card. Videos recorded during live view or playback is saved on your phone.
The device is offline?	<p>Check the indicator status:</p> <ul style="list-style-type: none"> • Solid green: Check whether the router can connect to the Internet. If the network is connected, restart the camera. • Flashing red: Reset the camera, and then configure the camera again. • Solid red: The camera is faulty.

Kurzanleitung

Cruiser

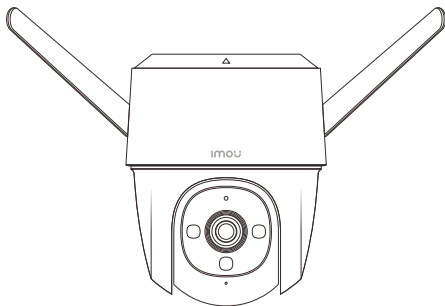

Willkommen

Vielen Dank, dass Sie sich für IMOUE entschieden haben. Wir sind bestrebt, einfachere Produkte für das intelligente Heim anzubieten. Wenn Sie Probleme bei der Verwendung des Produkts haben, wenden Sie sich bitte an unser Serviceteam.

Unsere Service-Mail lautet: service.global@imoulife.com

Häufig gestellte Fragen finden Sie unter imoulife.com/support/help



Packungsinhalt



Kamera x1



Kurzanleitung x1



Netzteil x1



Schrauben und
Dübe x1



Montageschablone x1



Montagehalterung x1



Wasserdichter
Anschluss x1

DE

Einführung in die Kamera

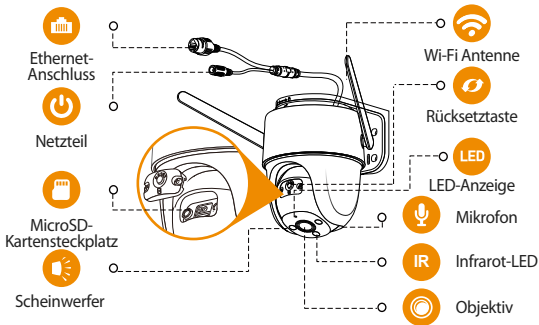

Hinweis: Trennen Sie die Kamera von der Stromversorgung, bevor Sie die SD-Karte einsetzen oder herausnehmen.

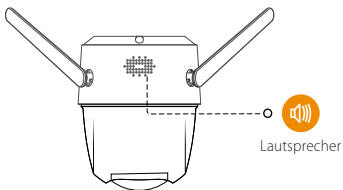

- Hinweis:**
1. Halten Sie die Rücksetz-/Kopplungstaste 10 Sekunden lang gedrückt, um die Kamera zurückzusetzen.
 2. Drücken Sie zweimal die Reset-Taste, um den Hotspot der Kamera zu aktivieren.

Informationen zur Bedeutung der LED-Signale entnehmen Sie bitte der folgenden Tabelle.

LED-Anzeigestatus	Gerätestatus
Aus	<ul style="list-style-type: none"> ● Gerät/LED ausgeschaltet ● Gerät fährt nach Rücksetzung hoch
Rot leuchtend	<ul style="list-style-type: none"> ● Gerät fährt hoch ● Gerätestörung
Rot blinkend	<ul style="list-style-type: none"> ● Netzwerkverbindung fehlgeschlagen ● Kopplung fehlgeschlagen
Grün blinkend	<ul style="list-style-type: none"> ● Bereit zur Netzwerkkonfiguration ● Bereit zum Koppeln
Grün leuchtend	<ul style="list-style-type: none"> ● Ordnungsgemäßer Betrieb
Abwechselnd grün und rot blinkend	<ul style="list-style-type: none"> ● Firmware wird aktualisiert

1 App herunterladen

DE

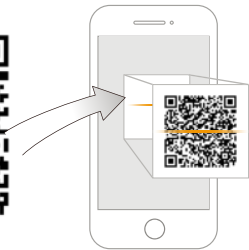

Imou Life



Download on the
App Store



GET IT ON
Google play



Windows

i Tips

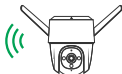
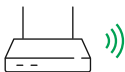
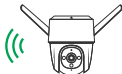
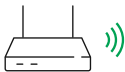

Um die bestmögliche Funkübertragung zu gewährleisten, stellen Sie sicher, dass zwischen Kamera und Router keine Hindernisse und elektromagnetische Störungen vorhanden sind.

2 Gerät zur App hinzufügen





3 Kamerainstallieren

Hinweis: Stellen Sie sicher, dass die Montagefläche stabil genug ist, um mindestens das dreifache Gewicht von Kamera und Halterung zu tragen.

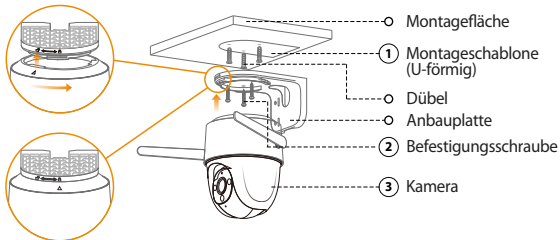
Deckenmontage



- ① Ziehen Sie die U-förmige Montageschablone ab und kleben Sie sie auf die gewünschte Montagefläche.
- ② Bohren Sie entsprechend den Markierungen auf der Montageschablone Löcher in die Montagefläche und setzen Sie bei Bedarf Dübel ein.
- ③ Befestigen Sie die Montagehalterung mit den mitgelieferten Schrauben an der Oberfläche.
- ④ Richten Sie \triangle an der Oberseite der Kamera mit  an der Halterung aus und fügen Sie dann die beiden Teile zusammen.
- ⑤ Drehen Sie die Kamera gegen den Uhrzeigersinn, bis sie fest sitzt. Achten Sie darauf, dass \triangle mit  ausgerichtet ist.
- ⑥ Schalten Sie die Kamera ein und stellen Sie ihren Winkel korrekt ein.

Wandmontage

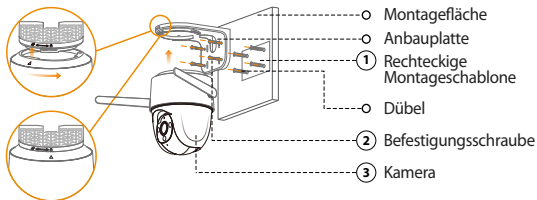



- ① Ziehen Sie die rechteckige Montageschablone ab und kleben Sie sie auf die gewünschte Montagefläche.
- ② Bohren Sie entsprechend den Markierungen auf der Montageschablone Löcher in die Montagefläche und setzen Sie bei Bedarf Dübel ein.
- ③ Befestigen Sie die Montagehalterung mit den mitgelieferten Schrauben an der Oberfläche.
- ④ Richten Sie \triangle an der Oberseite der Kamera mit  an der Halterung aus und fügen Sie dann die beiden Teile zusammen.

Guía de inicio rápido

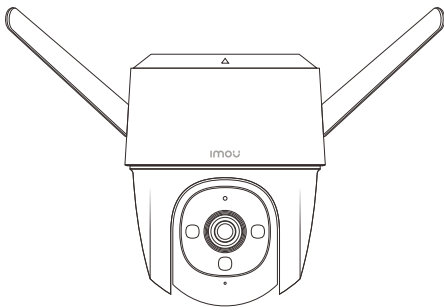
Cruiser





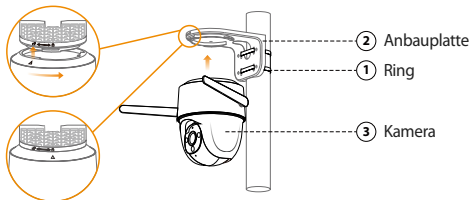

- ⑤ Drehen Sie die Kamera gegen den Uhrzeigersinn, bis sie fest sitzt. Achten Sie darauf, dass  mit  ausgerichtet ist.
- ⑥ Schalten Sie die Kamera ein und stellen Sie ihren Winkel korrekt ein.

Masthalterung

-  **Hinweis:** 1. Stellen Sie sicher, dass der Mast stabil genug ist, um mindestens das dreifache Gewicht von Kamera und Halterung zu tragen.
2. Die Ringe gehören nicht zum Lieferumfang. Bereiten Sie sie vorher vor.



- ① Führen Sie den Ring durch die Montagelöcher der Halterung und befestigen Sie die Halterung am Mast.
- ② Richten Sie  an der Oberseite der Kamera mit  an der Halterung aus und fügen Sie dann die beiden Teile zusammen.
- ③ Drehen Sie die Kamera gegen den Uhrzeigersinn, bis sie fest sitzt. Achten Sie darauf, dass  mit  ausgerichtet ist.
- ④ Schalten Sie die Kamera ein und stellen Sie ihren Winkel korrekt ein.

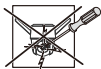

DC
12V1A

Fehlerbehebung

DE

Frage	Antwort
Das Gerät fährt nicht hoch oder funktioniert nicht erwartungsgemäß?	<ul style="list-style-type: none">Überprüfen Sie die Status-LED. Wenn sie nicht grün leuchtet, halten Sie die Reset-Taste 10 Sekunden lang gedrückt, um die Kamera zurückzusetzen.
Wie kann ich die Kamera mit einem anderen WLAN verbinden?	<ul style="list-style-type: none">Wenn die Kamera online ist, wählen Sie Gerätedetails > Netzwerkkonfig (Device Details > Network Config), um die WLAN-Verbindung in der App zu ändern.Wenn die Kamera offline ist, setzen Sie die Kamera zurück und konfigurieren Sie die Kamera anschließend erneut.
Das Verbinden dauert zu lange?	<ul style="list-style-type: none">Überprüfen Sie, ob der Abstand zwischen Kamera und Router und zwischen Kamera und Smartphone während des Verbindungsversuchs jeweils maximal 5 m beträgt.Überprüfen Sie die WLAN-Konfiguration des Routers: Stellen Sie Kanal auf Auto und den Modus auf 11bgn gemischt.
Wie wird die Videoaufzeichnung gespeichert, wenn die microSD-Karte voll ist?	<ul style="list-style-type: none">Wenn die microSD-Karte voll ist, überschreibt das System früher aufgezeichnete Videos. Speichern Sie wichtige Informationen rechtzeitig.
Wo werden die Videoaufzeichnungen gespeichert?	<ul style="list-style-type: none">Wenn Sie Cloudspeicherung aktiviert und eine microSD-Karte eingesetzt haben, werden die Aufnahmen sowohl auf der Karte als auch in der Cloud gespeichert. Wenn Cloudspeicher deaktiviert ist, werden die Aufnahmen auf der SD-Karte gespeichert. Während Live-Ansicht oder Wiedergabe aufgezeichnete Videos werden auf Ihrem Handy gespeichert.
Das Gerät ist offline?	<p>Überprüfen Sie die Status-LED:</p> <ul style="list-style-type: none">Grün leuchtend: Prüfen Sie, ob der Router eine Verbindung mit dem Internet herstellen kann. Wenn eine Verbindung zum Netzwerk besteht, starten Sie die Kamera neu.Rot blinkend: Setzen Sie die Kamera zurück und konfigurieren Sie sie anschließend erneut.Rot leuchtend: Die Kamera ist defekt.

Bienvenido

ES

Gracias por elegir IMOU

Nuestra misión es proporcionar productos fáciles de usar para un hogar inteligente. Si tiene problemas usando el producto, por favor diríjase a nuestro equipo de atención al cliente antes de devolver su producto.

Nuestro correo electrónico de servicio:
service.global@imoulife.com

Nos comprometemos a contestarle en 24 horas.

Puede encontrar respuesta a las preguntas más frecuentes en imoulife.com/support/help



Contenido del paquete



Cámara x1



Guía de inicio rápido x1



Adaptador de corriente x1



Bolsa con tornillos x1



plantilla de montaje x1



soporte de montura x1



Conector a prueba de agua x1

ES

Introducción a la cámara

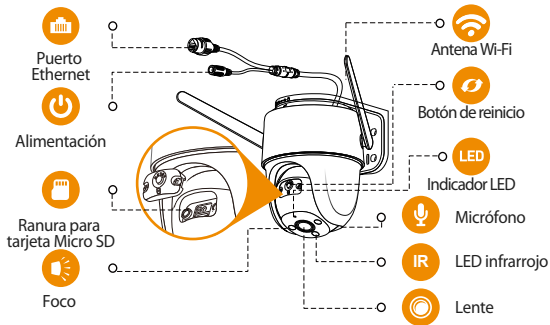

Nota: Desconecte la cámara de la alimentación antes de instalarla o de retirar la tarjeta SD.

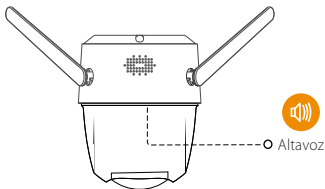

- Nota:**
1. Mantenga pulsado el botón de reinicio/emparejamiento durante 10 segundos para reiniciar la cámara.
 2. Pulse dos veces el botón de reinicio para habilitar el punto de acceso de la cámara.

Consulte la tabla siguiente para conocer el significado de los diferentes LED de la cámara.

Estado del indicador LED	Estado del dispositivo
Desactivar	<ul style="list-style-type: none"> ● Desconectado/LED apagado ● Nuevo arranque después del reinicio
Rojo fijo	<ul style="list-style-type: none"> ● Arranque ● Avería del dispositivo
Rojo parpadeante	<ul style="list-style-type: none"> ● Fallo de conexión de red ● Fallo de emparejamiento
Verde parpadeante	<ul style="list-style-type: none"> ● Listo para la configuración de la red ● Listo para emparejar
Verde fijo	<ul style="list-style-type: none"> ● Funcionando correctamente
Verde y rojo intermitente de forma alternativa	<ul style="list-style-type: none"> ● Actualizando firmware

1 Descargue la aplicación

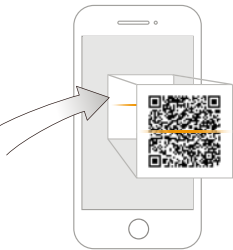

ES



i Tips

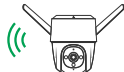

Para garantizar el mejor rendimiento inalámbrico posible, por favor asegúrese de que no hay obstáculos ni interferencias electromagnéticas entre la cámara y el enrutador.

2 Añadir dispositivo a la aplicación

ES





3 Instalación de la cámara

Nota: Asegúrese de que la superficie de montaje sea lo suficientemente resistente para soportar al menos tres veces el peso de la cámara y el soporte.

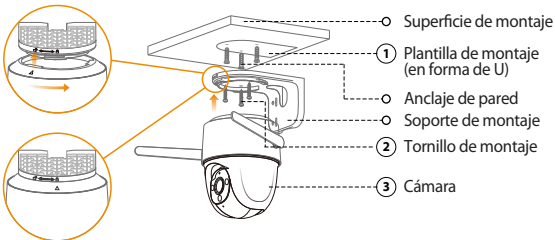
Montaje en techo



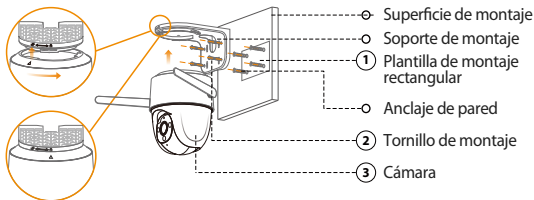

- ① Despegue la plantilla de montaje en forma de U y péguela en la zona que desee.
- ② Haga orificios en la superficie de montaje tal y como se indica en la plantilla de montaje y, a continuación, inserte los anclajes de pared según sea necesario.
- ③ Sujete de forma segura el soporte de montaje a la superficie con los tornillos de montaje incluidos.
- ④ Alinee \triangle la parte superior de la cámara con  en el soporte y, a continuación, junte las dos piezas.
- ⑤ Gire la cámara hacia la izquierda hasta que quede bloqueada. Asegúrese de que \triangle se alinee con .
- ⑥ Encienda la cámara y, a continuación, ajuste su ángulo correctamente.

Montaje en la pared







- ① Despegue la plantilla de montaje rectangular y péguela en la zona que desee.
- ② Haga orificios en la superficie de montaje tal y como se indica en la plantilla de montaje y, a continuación, inserte los anclajes de pared según sea necesario.
- ③ Sujete de forma segura el soporte de montaje a la superficie con los tornillos de montaje incluidos.
- ④ Alinee \triangle la parte superior de la cámara con  en el soporte y, a continuación, junte las dos piezas.

- ⑤ Gire la cámara hacia la izquierda hasta que quede bloqueada. Asegúrese de que  se alinee con .
- ⑥ Encienda la cámara y, a continuación, ajuste su ángulo correctamente.

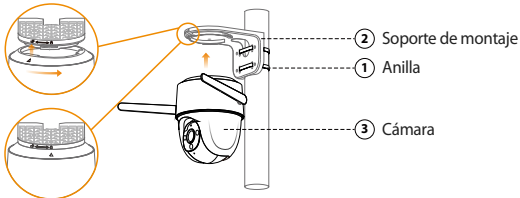
Montaje en poste

-  **Nota:** 1. Asegúrese de que el poste sea lo suficientemente resistente para soportar al menos tres veces el peso de la cámara y el soporte.
2. Las anillas no vienen incluidas. Adquiera las anillas antes de realizar la instalación.



- ① Pase la anilla a través de los orificios de montaje del soporte y seguidamente fije el soporte al poste de forma segura.
- ② Alinee  la parte superior de la cámara con  en el soporte y, a continuación, junte las dos piezas.
- ③ Gire la cámara hacia la izquierda hasta que quede bloqueada. Asegúrese de que  se alinee con .
- ④ Power on the camera and then adjust its angle properly.

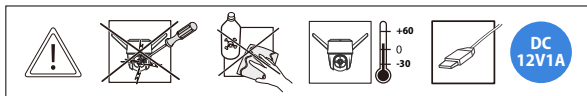

Solución de problemas

ES

Pregunta	Respuesta
¿El dispositivo no se inicia o no funciona correctamente?	<ul style="list-style-type: none">• Verifique el estado del indicador LED. Si el LED no se ilumina en verde, mantenga pulsado el botón de reinicio durante 10 segundos para reiniciar la cámara.
¿Cómo conectar la cámara a otra red Wi-Fi?	<ul style="list-style-type: none">• Si la cámara tiene conexión a Internet seleccione Detalles del dispositivo > Configuración de red(Device Details > Network Config) para cambiar la conexión Wi-Fi en la aplicación.• Si la cámara no tiene conexión a Internet, reiniciela y vuelva a configurarla.
¿Tarda demasiado en conectarse?	<ul style="list-style-type: none">• Compruebe si la distancia entre la cámara y el router, y entre la cámara y el teléfono inteligente es inferior a 5 m (16,4 pies) durante la conexión.• Compruebe la configuración Wi-Fi del router: Establezca el canal en automático y el modo en 11bgn mixto.
Cuando la tarjeta microSD está llena, ¿cómo se guardan los vídeos grabados?	<ul style="list-style-type: none">• Cuando la tarjeta microSD esté llena, el sistema sobrescribirá los vídeos grabados con anterioridad. Guarde la información importante oportunamente.
¿Dónde se guardan los vídeos grabados?	<ul style="list-style-type: none">• Si ha habilitado el almacenamiento en la nube e instalado una tarjeta microSD, las grabaciones se guardarán tanto en la tarjeta como en la nube. Si el almacenamiento en la nube no está habilitado, las grabaciones se guardan en la tarjeta SD. Los vídeos grabados durante la visualización en directo o la reproducción se guardarán en su teléfono.
¿El dispositivo no tiene conexión a Internet?	<p>Verifique el estado del indicador:</p> <ul style="list-style-type: none">• Verde fijo: Compruebe si el router puede conectarse a Internet. Si la red funciona correctamente, reinicie la cámara.• Rojo parpadeante: Reinicie la cámara y vuelva a configurarla.• Rojo fijo: La cámara no funciona correctamente.

Guide de démarrage rapide

Cruiser

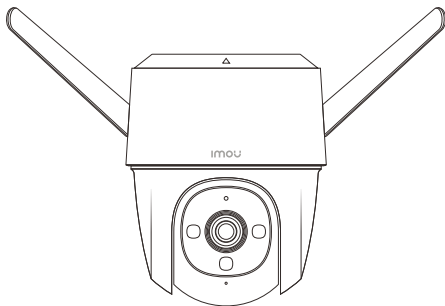

Bienvenue

FR

Merci d'avoir choisi IMOU.

Nous nous consacrons à fournir des produits pour la maison intelligente plus faciles à utiliser. Si vous rencontrez des difficultés lors de l'utilisation du produit, veuillez contacter notre équipe technique avant de renvoyer votre produit.

Notre courriel de service : service.global@imoulife.com

Nous nous engageons à vous répondre dans les 24 heures.

Les questions les plus fréquemment posées peuvent être consultées sur le site imoulife.com/support/help

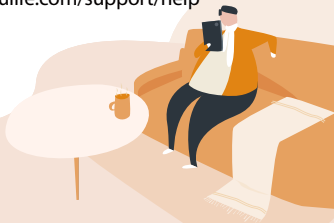

Contenu de l'emballage



Caméra x1



Guide de démarrage rapide x1



Adaptateur secteur x1



Paquet de vis x1



gabarit de montage x1



support de montage x1



Connecteur étanche x1

FR

Introduction à la caméra

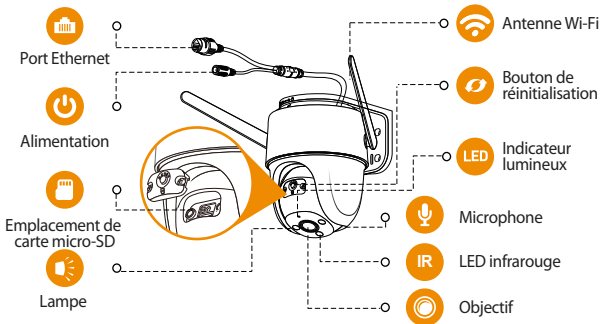

Remarque: Débranchez la caméra de l'alimentation avant de procéder à l'installation ou de retirer sa carte SD.

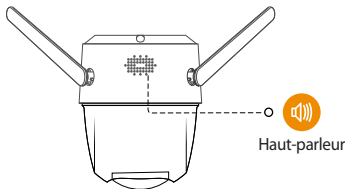

- Remarque:**
1. Appuyez et maintenez la touche de réinitialisation/couplage pendant 10 secondes pour réinitialiser la caméra.
 2. Appuyez deux fois sur le bouton réinitialiser pour activer le point d'accès de la caméra.

Reportez-vous au tableau ci-dessous pour la signification des voyants de la caméra.

Statut de l'indicateur lumineux	État des appareils
Désactivé	<ul style="list-style-type: none"> ● Appareil éteint/LED éteinte ● Redémarrage après remise à zéro
Rouge fixe	<ul style="list-style-type: none"> ● Amorçage ● Fonctionnement défectueux de l'appareil
Clignotement rouge	<ul style="list-style-type: none"> ● Échec de connexion au réseau ● Échec du couplage
Clignotement vert	<ul style="list-style-type: none"> ● Prêt pour la configuration du réseau ● Prêt à coupler
Vert fixe	<ul style="list-style-type: none"> ● Fonctionnement normal
Vert et rouge clignotant alternativement	<ul style="list-style-type: none"> ● Mise à jour du firmware

1 Télécharger l'application

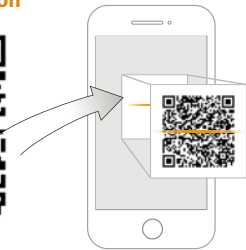

FR



Imou Life



Download on the
App Store



GET IT ON
Google play



Windows

i Tips

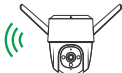
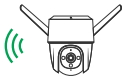

Pour garantir les meilleures performances sans fil possible, veuillez vous assurer qu'il n'y a pas d'obstacles ni d'interférences électromagnétiques entre la caméra et le routeur.

2 Ajouter un appareil à l'application





3 Installation de la caméra

Remarque: Assurez-vous que la surface de montage est suffisamment solide pour supporter au moins trois fois le poids de l'appareil et de son support.

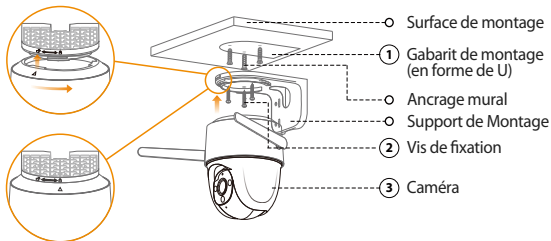
Montage plafond



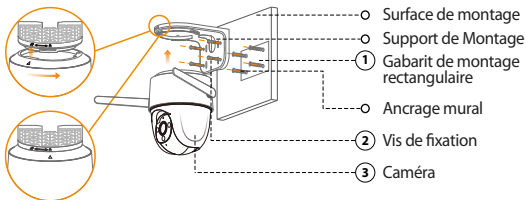

- ① Décollez le gabarit de montage en forme de U et collez-le sur le point d'installation souhaité.
- ② Percez des trous dans la surface de montage conformément aux marques du gabarit de montage, puis insérez les ancrages muraux si nécessaire.
- ③ Fixez le support de montage à la surface à l'aide des vis de fixation fournies.
- ④ Alignez \triangle la partie supérieure de la camera avec  sur le support, puis assemblez les deux parties ensemble.
- ⑤ Tournez la caméra dans le sens antihoraire jusqu'à ce qu'elle soit verrouillée. Assurez-vous que \triangle est aligné avec .
- ⑥ Allumez la caméra, puis ajustez son angle correctement.

Montage mural



- ① Décollez le gabarit de montage rectangulaire et collez-le sur le point d'installation souhaité.
- ② Percez des trous dans la surface de montage conformément aux marques du gabarit de montage, puis insérez les ancrages muraux si nécessaire.
- ③ Fixez le support de montage à la surface à l'aide des vis de fixation fournies.
- ④ Alignez \triangle la partie supérieure de la camera avec  sur le support, puis assemblez les deux parties ensemble.





- 5 Tournez la caméra dans le sens antihoraire jusqu'à ce qu'elle soit verrouillée.
Assurez-vous que  est aligné avec .
- 6 Allumez la caméra, puis ajustez son angle correctement.

Pole Mount

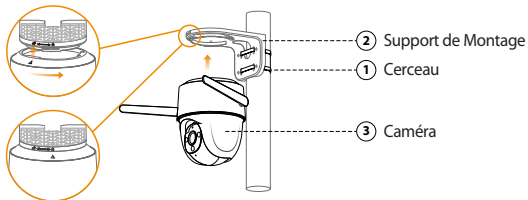
FR

-  **Remarque:** 1. Assurez-vous que le poteau est suffisamment solide pour supporter au moins trois fois le poids de la caméra et de son support.
2. Les cerceaux ne sont pas fournis. Veuillez les préparer à l'avance.



- 1 Faites passer le cerceau dans les trous de montage du support, puis fixez le support au poteau.
- 2 Alignez  la partie supérieure de la camera avec  sur le support, puis assemblez les deux parties ensemble.
- 3 Tournez la caméra dans le sens antihoraire jusqu'à ce qu'elle soit verrouillée.
Assurez-vous que  est aligné avec .
- 4 Allumez la caméra, puis ajustez son angle correctement.

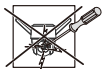

DC
12V1A

Fehlerbehebung

Question	Réponse
L'appareil ne démarre pas ou ne fonctionne pas comme prévu ?	<ul style="list-style-type: none">• Vérifiez l'état de l'indicateur lumineux. Si le voyant n'est pas vert, maintenez le bouton de réinitialisation enfoncé pendant 10 s pour réinitialiser la caméra.
Comment connecter la caméra à un autre réseau Wi-Fi ?	<ul style="list-style-type: none">• Si la caméra est en ligne, sélectionnez Détails de l'appareil > Config. réseau (Device Details > Network Config) pour modifier la connexion Wi-Fi sur l'application.• Si la caméra est hors ligne, réinitialisez-la, puis configurez-la à nouveau.
La connexion est trop longue à s'établir ?	<ul style="list-style-type: none">• Vérifiez si la distance entre la caméra et le routeur, et celle entre la caméra et le Smartphone, sont toutes deux inférieures à 5 m pendant la phase de connexion.• Vérifiez la configuration Wi-Fi du routeur : Réglez le canal sur auto et le mode sur 11 bgn mixte.
Lorsque la carte microSD est pleine, comment la vidéo enregistrée est-elle sauvegardée ?	<ul style="list-style-type: none">• Lorsque la carte microSD est pleine, le système écrase les vidéos enregistrées précédentes. Enregistrez les informations importantes à temps.
Où sont sauvegardées les vidéos enregistrées ?	<ul style="list-style-type: none">• Si vous avez activé le stockage dans le cloud et installé une carte microSD, les enregistrements seront à la fois sauvegardés sur la carte et dans le cloud. Si le stockage cloud est désactivé, les enregistrements sont sauvegardés sur la carte SD. Les vidéos enregistrées pendant la visualisation en direct ou la lecture sont enregistrées sur votre téléphone.
L'appareil est-il hors ligne ?	<p>Vérifiez l'état de l'indicateur lumineux :</p> <ul style="list-style-type: none">• Vert fixe : Vérifiez si le routeur peut se connecter à Internet. Si le réseau est connecté, redémarrez la caméra.• Clignotement rouge : Réinitialisez la caméra, puis configurez-la à nouveau.• Rouge fixe : La caméra est défectueuse.

imou
Enjoy Smart Life

Guida Rapida

Cruiser

IT

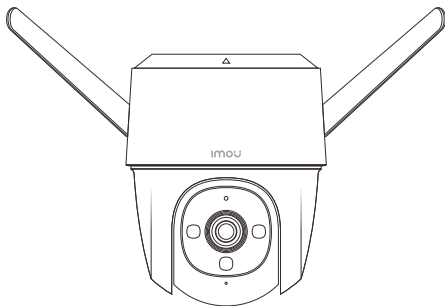

www.imoulife.com

Benvenuti

IT

Grazie per aver scelto IMOU.

Il nostro obiettivo è quello di fornire prodotti per la domotica più facili da utilizzare. In caso di problemi durante l'utilizzo del prodotto, si prega di contattare il nostro team di assistenza prima di restituire il prodotto.

La nostra e-mail per il servizio di assistenza:

service.global@imoulife.com

Promettiamo di rispondere entro 24 ore.

Le risposte alle domande più frequenti sono disponibili all'indirizzo imoulife.com/support/help

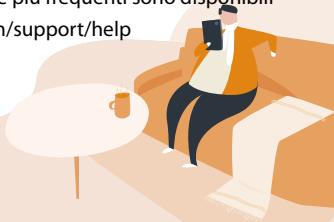

Contenuto della confezione



Telecamera x1



Guida
introduttiva x1



Adattatore x1



Kit di viti x1



Dima di
foratura x1



Staffa di montaggio x1



Connettore
impermeabile x1

IT

Introduzione alla telecamera

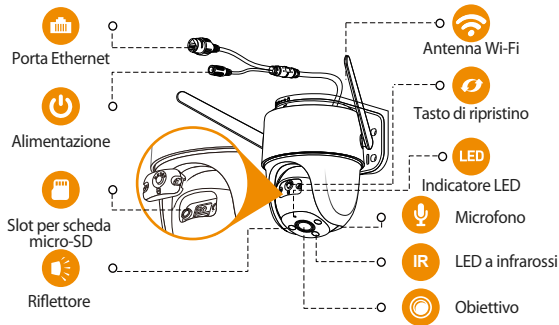

Nota: Scollegare la telecamera dall'alimentazione prima di installarla o di estrarre la scheda SD.

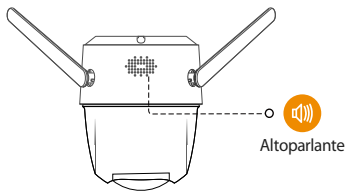

- Nota:** 1. Tenere premuto per 10 secondi il pulsante Reimposta/Associa per reimpostare la telecamera.
 2. Premere due volte il pulsante di reset per attivare l'hotspot della telecamera.

Consultare la tabella seguente per le definizioni dei comportamenti del LED della telecamera.

Stato dell'indicatore a LED	Stato del dispositivo
Disattivo	<ul style="list-style-type: none"> ● Spento/LED spento ● Riavvio dopo il ripristino
Rosso fisso	<ul style="list-style-type: none"> ● Avvio ● Malfunzionamento del dispositivo
Rosso lampeggiante	<ul style="list-style-type: none"> ● Connessione di rete non riuscita ● Abbinamento non riuscito
Verde lampeggiante	<ul style="list-style-type: none"> ● Pronto per la configurazione di rete ● Pronto per l'abbinamento
Verde fisso	<ul style="list-style-type: none"> ● Funzionamento normale
Verde e rosso lampeggianti alternativamente	<ul style="list-style-type: none"> ● Aggiornamento firmware

1 Scarica l'app

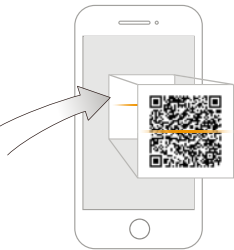

IT



Imou Life



Download on the
App Store



GET IT ON
Google play



Windows

i Tips

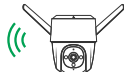

Per garantire le migliori prestazioni wireless possibili, assicurarsi che non ci siano ostacoli e interferenze elettromagnetiche tra la telecamera e il router.

3 ? aggiungere il dispositivo all'app

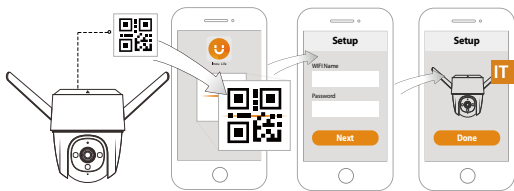



3 Installazione della telecamera

 **Nota:** Verificare che la superficie di montaggio sia abbastanza resistente da sopportare almeno tre volte il peso della telecamera e della staffa.

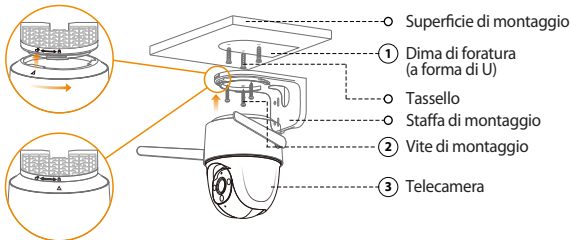
Kit per montaggio a incasso



- ① Separare la dima di foratura a forma di U e fissarla all'area di installazione prevista.
- ② Praticare fori sulla superficie sottostante, nei punti indicati sulla dima di foratura, quindi inserire i tasselli opportuni.
- ③ Fissare la staffa di montaggio alla superficie con le viti di montaggio in dotazione.
- ④ Allineare il simbolo \triangle sulla sommità della telecamera con il simbolo  sulla staffa, quindi assemblare tra loro le due parti.
Ruotare la telecamera in senso antiorario fino a bloccarla. Assicurarsi che \triangle sia allineato con .
- ⑤ Accendere la telecamera e regolarne l'angolazione.

Kit di montaggio a parete

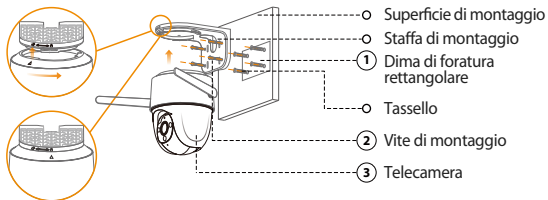

- ① Separare la dima di foratura rettangolare e fissarla all'area di installazione prevista.
- ② Praticare fori sulla superficie sottostante, nei punti indicati sulla dima di foratura, quindi inserire i tasselli opportuni.
- ③ Fissare la staffa di montaggio alla superficie con le viti di montaggio in dotazione.
- ④ Allineare il simbolo \triangle sulla sommità della telecamera con il simbolo  sulla staffa, quindi assemblare tra loro le due parti.



- 5 Ruotare la telecamera in senso antiorario fino a bloccarla. Assicurarsi che \triangle sia allineato con .
- 6 Power on the camera and then adjust its angle properly.

Kit di montaggio su palo

- Nota:** 1. Verificare che il palo sia abbastanza resistente da sopportare almeno tre volte il peso della telecamera e della staffa.
2. Le fascette non sono in dotazione. Prepararle in anticipo.

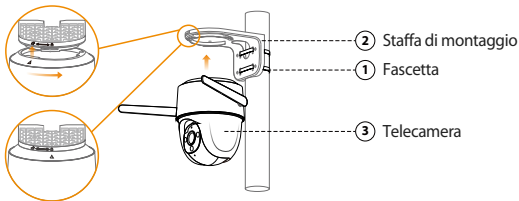
IT



- 1 Inserire la fascetta nei fori di montaggio, sulla staffa, quindi fissare la staffa al palo.
- 2 Allineare il simbolo \triangle sulla sommità della telecamera con il simbolo  sulla staffa, quindi assemblare tra loro le due parti.
- 3 Ruotare la telecamera in senso antiorario fino a bloccarla. Assicurarsi che \triangle sia allineato con .
- 4 Accendere la telecamera e regolarne l'angolazione.

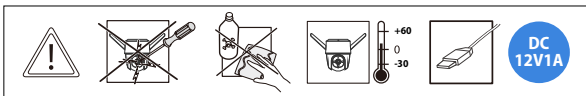

Risoluzione dei problemi

Domanda	Risposta
Il dispositivo non si avvia o non funziona come previsto?	<ul style="list-style-type: none">Controllare il LED luminoso indicatore di stato. Se la luce non è verde, tenere premuto il pulsante di reset per 10 secondi per ripristinare la telecamera.
Come connettere la telecamera a un'altra rete Wi-Fi?	<ul style="list-style-type: none">Se la telecamera è online, selezionare Dettagli dispositivo > Configurazione rete (Device Details > Network Config) per modificare la connessione Wi-Fi sull'app.Se la telecamera è offline, reimpostarla e configurarla di nuovo.
La connessione richiede troppo tempo?	<ul style="list-style-type: none">Controllare che la distanza tra la telecamera e il router e quella tra la telecamera e lo smartphone siano inferiori a 5 m, durante la connessione.Verificare la configurazione Wi-Fi del router: selezionare per il canale la modalità automatica e per la modalità l'opzione 11 bgn mixed.
Quando la scheda micro SD è piena, come vengono salvati i video registrati?	<ul style="list-style-type: none">Quando la scheda micro SD è piena, il sistema sovrascrive i video registrati in precedenza. Salvare i contenuti importanti in anticipo.
Dove vengono salvati i video registrati?	<ul style="list-style-type: none">Se la memoria sul cloud è stata attivata ed è stata installata una scheda micro SD, le registrazioni vengono salvate sia nella scheda che sul cloud. Se l'archiviazione sul cloud è disattivata, le registrazioni vengono salvate sulla scheda SD. I video registrati durante la visualizzazione live o la riproduzione vengono salvati sul telefono.
Il dispositivo è offline?	Controllare l'indicatore di stato: <ul style="list-style-type: none">Verde fisso: verificare che il router possa connettersi a Internet. Se la connessione di rete è attiva, riavviare la telecamera.Rosso lampeggiante: Reimpostare la telecamera, quindi riconfigurarla.Rosso fisso: la telecamera è difettosa.

Snelstartgids

Cruiser

NL

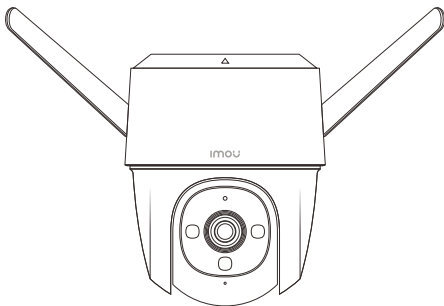

Welkom

Bedankt dat u voor Imou heeft gekozen.

NL

Onze toewijding is om u eenvoudige Smart Home producten te bieden. Als u problemen ervaart met het gebruik van uw product, neem dan eerst contact op met onze service team: service.global@imoulife.com



Inhoud verpakking



Camera x1



Snelstarhandleiding x1



Spanningsadapter x1



Schroevenset x1



Montagesjabloon x1



Montagebeugel x1



Waterdichte
connector x1

NL

Introductie camera

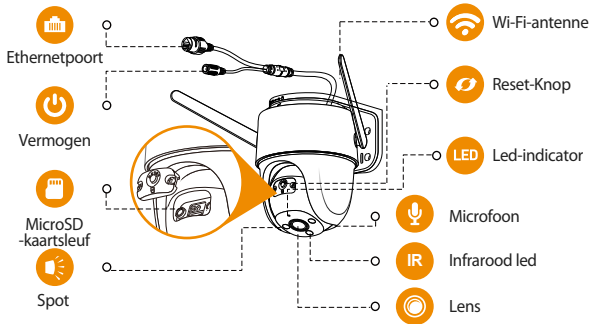

Opmerking: Ontkoppel de camera van de stroom voordat u hem installeert of de SD-kaart eruit haalt.

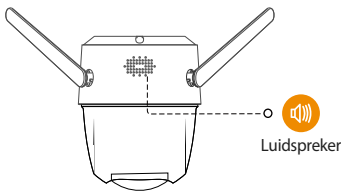

- Opmerking:**
1. Druk de reset-/koppelknop 10 seconden in om de camera te resetten.
 2. Dubbelklik op de resetknop om de hotspot van de camera in te schakelen.

Zie onderstaande tabel voor definities van het gedrag van de led van de camera.

LED-Indicator Status	Apparaatstatus
Uit	<ul style="list-style-type: none"> ● Uitgeschakeld/LED is uitgeschakeld ● Opnieuw opstarten na reset
Constant rood	<ul style="list-style-type: none"> ● bezig met opstarten ● Storing van het apparaat
Knippert rood	<ul style="list-style-type: none"> ● Netwerkverbinding mislukt ● Koppeling mislukt
Knippert groen	<ul style="list-style-type: none"> ● Klaar voor netwerkconfiguratie ● Klaar om te koppelen
Constant groen	<ul style="list-style-type: none"> ● Werkt zoals dat moet
Knipperend afwisselend groen en rood	<ul style="list-style-type: none"> ● Firmware bijwerken

1 Download de app

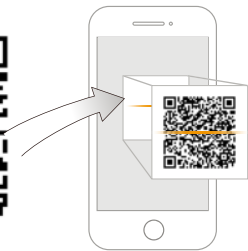

NL



i Tips

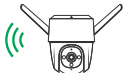
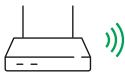
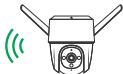
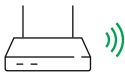

Zorg voor de best mogelijke draadloze prestatie dat er geen obstakels en elektromagnetische interferentie tussen de camera en router aanwezig zijn.

2 Apparaat toevoegen aan de app





3 Het installeren van de camera

Opmerking: Controleer dat het montagevlak sterk genoeg is om minstens drie keer het gewicht van de camera en de montagebeugel te dragen.

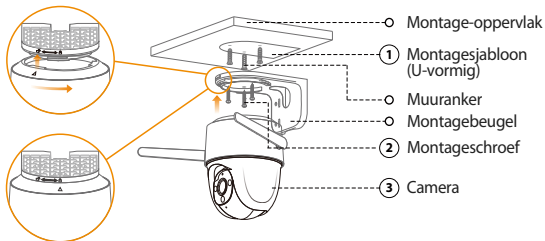
Montagebeugel voor plafond





- ① Verwijder de folie van het U-vormige montagesjabloon en plak het op de gewenste installatieplaats.
- ② Boor gaten in het montagevlak volgens de markering van het montagesjabloon en duw de muurankers in de muur indien nodig.
- ③ Bevestig de montagebeugel met de bijgeleverde montageschroeven op het montagevlak.
- ④ Lijn \triangle de bovenkant van de camera uit met  op de montagebeugel en pas de twee delen vervolgens in elkaar.
- ⑤ Draai de camera tegen de klok in totdat deze is vergrendeld. Zorg ervoor dat \triangle is uitgelijnd met .
- ⑥ Schakel de camera in en stel de hoek af.

NL

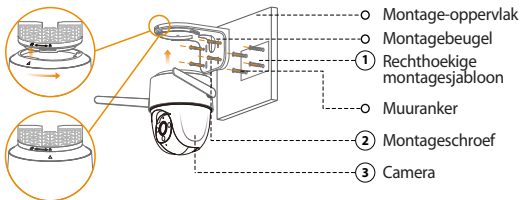
Wandmontage



- ① Verwijder de folie van het rechthoekige montagesjabloon en plak het op de gewenste installatieplaats.
- ② Boor gaten in het montagevlak volgens de markering van het montagesjabloon en duw de muurankers in de muur indien nodig.
- ③ Bevestig de montagebeugel met de bijgeleverde montageschroeven op het montagevlak.
- ④ Lijn \triangle de bovenkant van de camera uit met  op de montagebeugel en pas de twee delen vervolgens in elkaar.





- ⑤ Draai de camera tegen de klok in totdat deze is vergrendeld. Zorg ervoor dat  is uitgelijnd met .
- ⑥ Schakel de camera in en stel de hoek af.

Opbouw voor mast

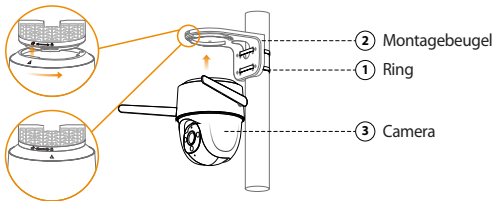
-  **Opmerking:** 1. Controleer dat de mast sterk genoeg is om minstens drie keer het gewicht van de camera en de beugel te dragen.
2. De ringen worden niet meegeleverd. Bereid ze voor.

NL



- ① Haal de ring door de bevestigingsgaten van de beugel en bevestig de beugel vervolgens aan de mast.
- ② Lijn  de bovenkant van de camera uit met  op de montagebeugel en pas de twee delen vervolgens in elkaar.
- ③ Draai de camera tegen de klok in totdat deze is vergrendeld. Zorg ervoor dat  is uitgelijnd met .
- ④ Schakel de camera in en stel de hoek af.



DC
12V1A

Probleemoplossing

Vraag	Antwoord
Het apparaat start niet op zoals verwacht.	<ul style="list-style-type: none">Controleer de led-indicatorstatus. Als het lampje niet groen brand, houdt u de resetknop 10 seconden ingedrukt om de camera te resetten.
Hoe moet ik de camera verbinden met een ander wifi-netwerk?	<ul style="list-style-type: none">Als de camera online is, selecteert u Apparaatdetails > Netwerkconfiguratie (Device Details > Network Config) om de wifi-verbinding via de app te wijzigen.Als de camera offline is, reset u de camera en configureert u de camera opnieuw.
Verbinden duurt lang.	<ul style="list-style-type: none">Controleer of de afstand tussen de camera en de router en de afstand tussen de camera en de smartphone beide minder is dan 5 meter tijdens het verbinden.Controleer de wifi-configuratie van de router: Stel het kanaal in op automatisch en de modus op 11 bgn gemengd.
Hoe wordt de opgenomen video's opgeslagen als de microSD-kaart vol is?	<ul style="list-style-type: none">Als de microSD-kaart vol is, zal het systeem de eerder opgenomen video's overschrijven. Bewaar belangrijke informatie tijdig.
Waar worden de opgenomen video's opgeslagen?	<ul style="list-style-type: none">Als u de cloudopslag heeft geactiveerd en een microSD-kaart heeft geïnstalleerd, worden de opnamen zowel op de microSD-kaart als in de cloud opgeslagen. Als de cloudopslag is uitgeschakeld, worden de opnamen op de microSD-kaart opgeslagen. Video's die tijdens de liveweergave of het afspelen zijn opgenomen, worden op uw telefoon opgeslagen.
Het apparaat is offline.	<p>Controleer de indicatorstatus:</p> <ul style="list-style-type: none">Constant groen: Controleer of de router verbinding kan maken met het internet. Als het netwerk is aangesloten, start u de camera opnieuw op.Knippert rood: Reset de camera en configureer de camera vervolgens opnieuw.Constant rood: De camera is defect.



Guia rápido

Cruiser

PT

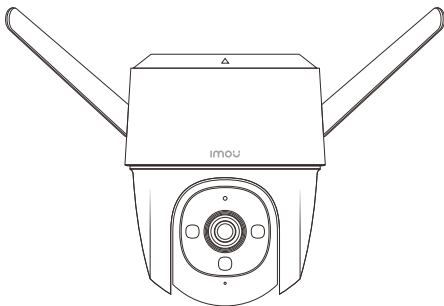

Bem-vindo

Obrigado por escolher a IMOU.

Estamos empenhados em fornecer produtos inteligentes e simplificados para o lar. Se tiver problemas ao utilizar o produto, contacte a nossa equipa de assistência antes de devolver o produto.

PT

O nosso e-mail de assistência: service.global@imoulife.com-
Prometemos responder no prazo de 24 horas.

Pode encontrar as Perguntas frequentes em [imoulife.com/
support/help](https://imoulife.com/support/help)

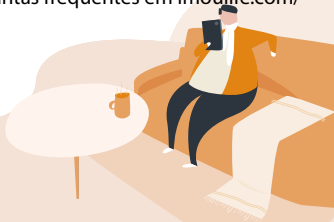

Conteúdo da embalagem



Câmara x1



Guia de Início Rápido x1



Adaptador x1



Conjunto de parafusos x1



Modelo de montagem x1



Suporte de montagem x1



Conector impermeável x1

PT

Apresentação da câmara

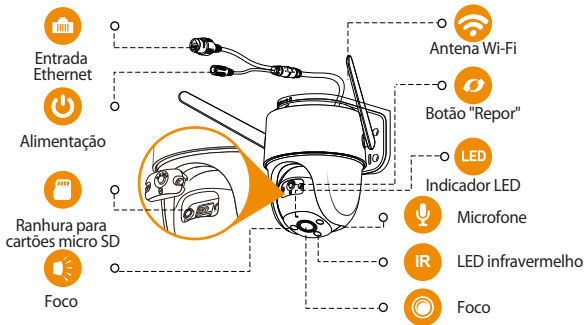

Nota: Desligue a câmara da alimentação antes de proceder à instalação ou tire o cartão SD.

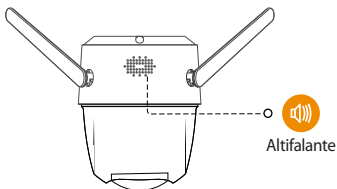

PT

- Nota:**
1. Prima sem soltar o botão Reset/Pair durante 10 segundos para repor a câmara.
 2. Prima duas vezes o botão de reiniciar para ativar o hotspot da câmara.

Consulte a tabela abaixo com a explicação dos comportamentos do LED da câmara.

Estado do indicador LED	Estado do dispositivo
Desligado	<ul style="list-style-type: none">● Desligado/LED desligado● Reiniciar após a reposição
Vermelho fixo	<ul style="list-style-type: none">● Arranque● Avaria do dispositivo
Vermelho intermitente	<ul style="list-style-type: none">● Ligação à rede falhou● O emparelhamento falhou
Verde intermitente	<ul style="list-style-type: none">● Pronto para configuração da rede● Pronto a emparelhar
Verde fixo	<ul style="list-style-type: none">● A funcionar corretamente
Verde e vermelho intermitentes alternadamente	<ul style="list-style-type: none">● A atualizar o firmware

1 Transferir a aplicação

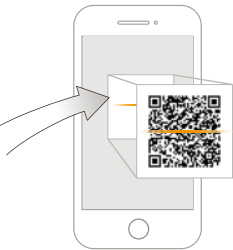

PT



Imou Life



Download on the
App Store



GET IT ON
Google play



Windows

i Tips

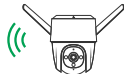

Para assegurar o melhor desempenho possível do sistema sem fios, certifique-se de que não existem obstáculos e interferência eletromagnética entre a câmara e o router.

2 Adicionar o dispositivo à aplicação

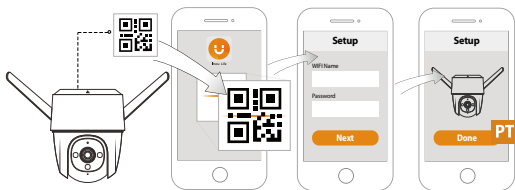



3 Instalar a câmara

Nota: Certifique-se de que a superfície de montagem é suficientemente forte para suportar, pelo menos, três vezes o peso da câmara e do suporte.

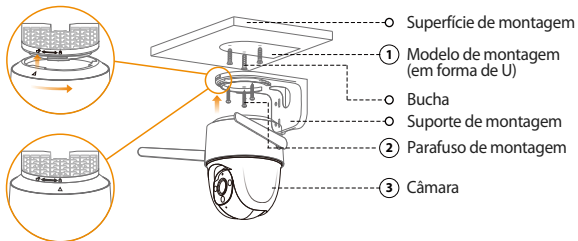
Montagem no teto



- 1 Destaque o modelo de montagem em U e cole-o na área de instalação pretendida.
- 2 Faça furos na superfície de montagem de acordo com as marcações do modelo de montagem e, em seguida, insira as buchas conforme necessário.
- 3 Fixe o suporte de montagem na superfície com os parafusos de montagem incluídos.
- 4 Alinhe \triangle na parte superior da câmara com  no suporte e encaixe as partes. Rode a câmara no sentido contrário ao dos ponteiros do relógio até bloquear.
- 5 Certifique-se de que \triangle está alinhado com .
- 6 Ligue a câmara e, em seguida, ajuste o ângulo.

Montagem em parede

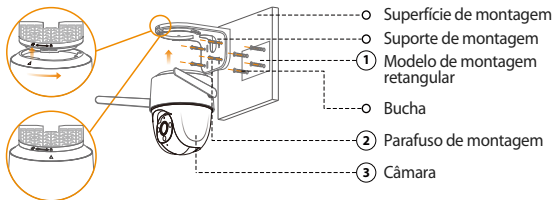

- 1 Destaque o modelo de montagem retangular e cole-o na área de instalação pretendida.
- 2 Faça furos na superfície de montagem de acordo com as marcações do modelo de montagem e, em seguida, insira as buchas conforme necessário.
- 3 Fixe o suporte de montagem na superfície com os parafusos de montagem incluídos.
- 4 Alinhe \triangle na parte superior da câmara com  no suporte e encaixe as partes.



- ⑤ Rode a câmara no sentido contrário ao dos ponteiros do relógio até bloquear. Certifique-se de que \triangle está alinhado com  .
- ⑥ Ligue a câmara e, em seguida, ajuste o ângulo.

Montagem em poste

-  **Nota:** 1. Certifique-se de que o poste é suficientemente forte para suportar, pelo menos, três vezes o peso da câmara e do suporte.
2. Os aros não são fornecidos. Prepare-os com antecedência.

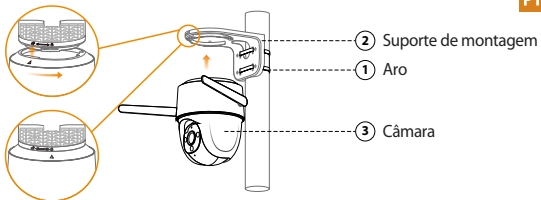
PT



- ① Passe o aro através dos furos de montagem do suporte, em seguida, fixe o suporte no poste.
- ② Alinhe \triangle na parte superior da câmara com  no suporte e encaixe as partes. Rode a câmara no sentido contrário ao dos ponteiros do relógio até bloquear.
- ③ Certifique-se de que \triangle está alinhado com  .
- ④ Ligue a câmara e, em seguida, ajuste o ângulo.



DC
12V1A

Solução de problema

Pergunta	Resposta
O dispositivo não inicia ou não funciona como esperado?	<ul style="list-style-type: none">• Verifique o estado do indicador LED. Se a luz não estiver verde, prima sem soltar o botão de reiniciar durante 10 s para reiniciar a câmara.
Como ligar a câmara a outra rede Wi-Fi?	<ul style="list-style-type: none">• Se a câmara estiver online, selecione Detalhes do dispositivo > Configuração da rede (Device Details > Network Config) para mudar a ligação Wi-Fi na aplicação.• Se a câmara estiver offline, reinicie a câmara e, em seguida, configure-a novamente.
A ligação demora muito tempo?	<ul style="list-style-type: none">• Verifique se a distância entre a câmara e o router, e entre a câmara e o smartphone, está dentro de 5 m (16,4 pés) durante a ligação.• Verifique a configuração Wi-Fi do router: Regule o canal para auto e o modo para 11bgn misto.
Quando o cartão micro SD está cheio, como é que o vídeo é gravado?	<ul style="list-style-type: none">• Quando o cartão micro SD está cheio, o sistema substitui os vídeos gravados anteriormente. Guarde informação importante a tempo.
Onde são guardados os vídeos gravados?	<ul style="list-style-type: none">• Se tiver ativado o armazenamento na nuvem e instalado um cartão micro SD, as gravações serão guardadas no cartão e na nuvem. Se o armazenamento na nuvem estiver desativado, as gravações são guardadas no cartão SD. Os vídeos gravados durante a visualização em direto ou a reprodução são guardados no seu telefone.
O dispositivo está offline?	Verifique o estado do indicador: <ul style="list-style-type: none">• Verde fixo: Verifique se o router está ligado à Internet. Se a rede estiver ligada, reinicie a câmara.• Vermelho intermitente: Reinicie a câmara e configure-a novamente.• Vermelho fixo: A câmara está avariada.

دليل البدء السريع Cruiser

AR

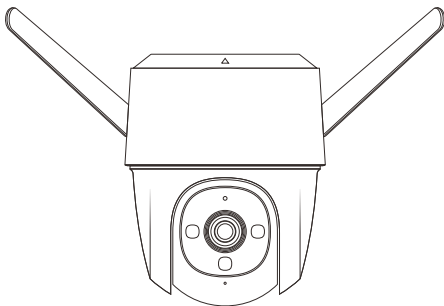

أهلا بك

شكرا لاختيارك IMOU

نحن ملتزمون بتزويدك بمنتجات منزلية ذكية و سهلة الاستخدام.
إذا كان لديك مشاكل في استخدام المنتج، يرجى الاتصال
بفريق الخدمة لدينا قبل إعادة المنتج الخاص بك..

AR

بريد خدمتنا: service.global@imoulife.com

يمكن العثور على الأسئلة المتداولة في الموقع
imoulife.com/support/help



محتوى العلبة



1 × الكاميرا



1 × دليل البدء السريع



1 × محول الطاقة



1 × حزمة براغي التثبيت



1 × قالب التركيب



1 × أقواس التركيب



1 × موصل مقاوم للماء

AR

مقدمة عن الكاميرا

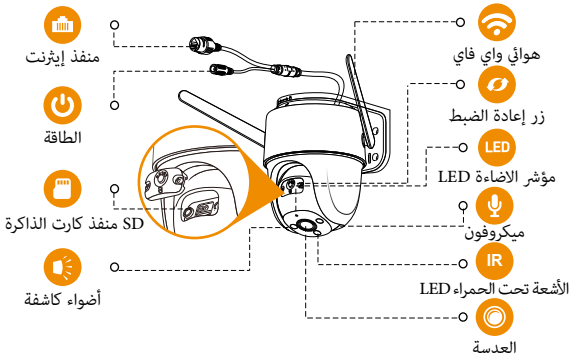

ملحوظة: افصل الكاميرا عن الطاقة قبل تثبيت أو إخراج بطاقة SD الخاصة بها.

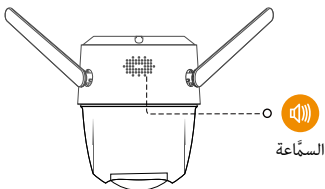

AR

ملحوظة : اضغط مع الاستمرار على زر إعادة الضبط لمدة 10 ثوانٍ لإعادة ضبط الكاميرا
اضغط مرتين على زر إعادة الضبط لتفعيل نقطة اتصال الكاميرا

راجع الجدول أدناه للحصول على تعريف سلوكيات ضوء الكاميرا LED

حالة الجهاز	حالة مؤشر الاضاءة LED
<ul style="list-style-type: none"> ● إيقاف التشغيل / إطفاء الاضاءة LED ● إعادة التشغيل بعد إعادة اعدادات المصنع 	إيقاف
<ul style="list-style-type: none"> ● اقلاع ● عطل في الجهاز 	أحمر ثابت
<ul style="list-style-type: none"> ● فشل الاتصال بالشبكة ● فشل الاقتران 	وميض باللون الأحمر
<ul style="list-style-type: none"> ● جاهز لاعدادات الشبكة ● جاهز للاقتران 	وميض باللون الأخضر
<ul style="list-style-type: none"> ● تعمل بشكل صحيح 	أخضر ثابت
<ul style="list-style-type: none"> ● تحديث البرنامج الأساسي 	وميض الأخضر والأحمر بالتناوب

1 تحميل التطبيق

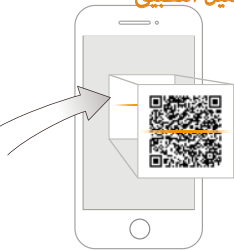

AR



i Tips

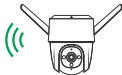
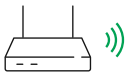
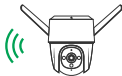

لضمان أفضل أداء اتصال لاسلكي ممكن، يرجى التأكد من عدم وجود عوائق أو كهرومغناطيسية تتداخل بين الكاميرا و الراوتر.

2 اضافة جهاز الى التطبيق

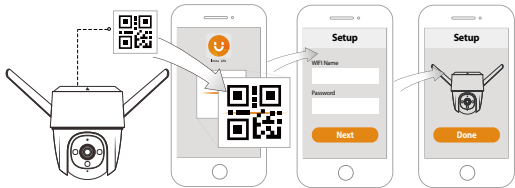

AR

3 تركيب الكاميرا

ملحوظة : تأكد من أن سطح التركيب قوي بما يكفي لحمل على الأقل ثلاثة أضعاف وزن الكاميرا والقوس الحامل للكاميرا.

التثبيت على السقف

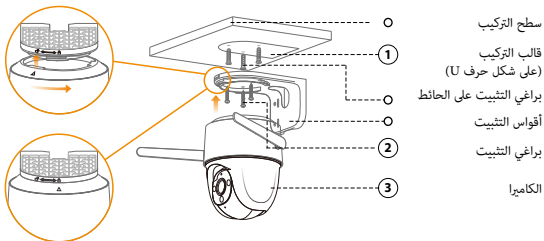

- ① انزع لصاقة قالب التركيب (على شكل حرف U) وأصقه بمنطقة التثبيت المطلوبة.
- ② احفر ثقبًا في سطح التركيب مماثلة لأماكن الثقوب في قالب التركيب ثم أدخل براغي التثبيت على الحائط حسب الحاجة.
- ③ قم بتثبيت أقواس التركيب على السطح باستخدام براغي التثبيت المرفقة.
- ④ قم بمحاذاة Δ في الجزء العلوي من الكاميرا مع \square على الحامل، ثم قم بتركيب الجزأين معًا.
- ⑤ قم بتدوير الكاميرا عكس اتجاه عقارب الساعة حتى يتم قفلها. تأكد من محاذاة Δ مع \square .
- ⑥ قم بتشغيل الكاميرا ثم اضبط زاوية الرؤية بشكل صحيح.

AR

تثبيت على الحائط

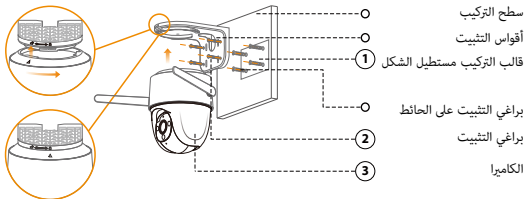

- ① انزع لصاقة قالب التثبيت مستطيل الشكل وأصقه بمنطقة التثبيت المطلوبة.
- ② احفر ثقبًا في سطح التركيب مماثلة لأماكن الثقوب في قالب التركيب ثم أدخل براغي التثبيت على الحائط حسب الحاجة.
- ③ قم بتثبيت أقواس التركيب على السطح باستخدام براغي التثبيت المرفقة.
- ④ قم بمحاذاة Δ في الجزء العلوي من الكاميرا مع \square على الحامل، ثم قم بتركيب الجزأين معًا.

- 5 قم بتدوير الكاميرا عكس اتجاه عقارب الساعة حتى يتم قفلها. تأكد من محاذاة \triangle مع \square .
- 6 قم بتشغيل الكاميرا ثم اضبط زاوية الرؤية بشكل صحيح.

طريقة التثبيت على العمود

ملحوظة : تأكد من أن العمود قوي بما يكفي ليحمل ثلاث مرات على الأقل وزن الكاميرا وقوس التثبيت.
لم يتم توفير الحلقات. يرجى تحضيرهم مسبقًا.

AR

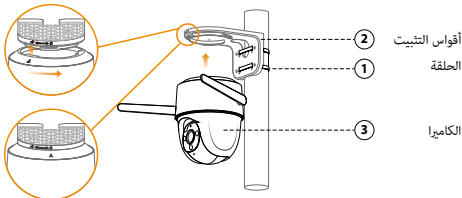

مرر الحلقة من خلال فتحات التثبيت الموجودة على الحامل، ثم قم بتوصيل الدعامة بالعمود.
قم بمحاذاة \triangle في الجزء العلوي من الكاميرا مع \square الحامل، ثم قم بتركيب الجزأين معًا.
قم بتدوير الكاميرا عكس اتجاه عقارب الساعة حتى يتم قفلها. تأكد من \triangle محاذاة مع \square .
قم بتشغيل الكاميرا ثم اضبط زاوية الرؤية بشكل صحيح.

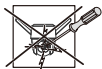

DC
12V1A

إضافة جهاز الى التطبيق

سؤال	اجابة
الجهاز لا يمكنه الاقلاع أو العمل كما هو متوقع؟	<ul style="list-style-type: none"> تحقق من حالة مؤشر الضوء LED إذا لم يكن الضوء باللون الأخضر، فاضغط مع الاستمرار على زر إعادة الضبط لمدة 10 ثوانٍ لإعادة ضبط اعدادات الكاميرا
كيف توصل الكاميرا بشبكة اتصال واي فاي أخرى؟	<ul style="list-style-type: none"> إذا كانت الكاميرا متصلة بالإنترنت، حدد تفاصيل الجهاز < اعدادات الشبكة لتبديل اتصال واي فاي على التطبيق. إذا كانت الكاميرا غير متصلة بالإنترنت، فأعد ضبط اعدادات الكاميرا، ثم قم بتعيين اعدادات الكاميرا مرة أخرى.
الاتصال يستغرق وقتا طويلا؟	<ul style="list-style-type: none"> تحقق مما إذا كانت المسافة بين الكاميرا والراوتر، والمسافة بين الكاميرا والهاتف الذي كلاهما في نطاق 5 أمتار (16.4 قدمًا) أثناء الاتصال. تحقق من اعدادات واي فاي لجهاز الراوتر: حدد القناة إلى اتصال تلقائي (auto) ، و الوضع إلى 11bgn mixed
عندما تكون بطاقة Micro SD ممتلئة فكيف يمكن حفظ الفيديو المسجل؟	<ul style="list-style-type: none"> عندما تمتلئ بطاقة micro SD، سيقوم النظام بالتسجيل فوق مقاطع الفيديو المسجلة سابقا. احفظ المعلومات المهمة في الوقت المناسب.
أين يتم حفظ مقاطع الفيديو المسجلة؟	<ul style="list-style-type: none"> إذا قمت بتنشيط التخزين السحابي وقمت بتثبيت بطاقة micro SD فسيتم حفظ التسجيلات على البطاقة والسحابة معا. إذا تم إلغاء تنشيط التخزين السحابي، فسيتم حفظ التسجيلات في بطاقة SD. مقاطع الفيديو المسجلة أثناء العرض المباشر أو خلال إعادة العرض يتم حفظها على هاتفك.
الجهاز غير متصل؟	<ul style="list-style-type: none"> تحقق من حالة المؤشر: أخضر ثابت: تحقق مما إذا كان جهاز الراوتر متصل بالإنترنت. إذا كانت الشبكة متصلة، فأعد تشغيل الكاميرا. وميض متقطع باللون الأحمر: أعد ضبط الكاميرا، ثم قم بوضع اعدادات الكاميرا مرة أخرى. أحمر ثابت: الكاميرا بها عيوب.

imou

Enjoy Smart Life



CE FC CCC UL  ISO 9001:2000

 @imouglobal

 service.global@imoulife.com

 www.imoulife.com