

DE

Montageanleitung

FR

Notice de montage

NL

Handleiding voor de montage

CZ

Montážní návod

HU

Szerelési útmutató

TR

Montaj talimatı

PT

Instruções de montagem

AR

تعليمات التجميع

GB USA

Assembly instructions

IT

Istruzione di montaggio

PL

Instrukcja montażu

SK

Návod na montáž

RO

Instrucțiuni de montaj

RU

Инструкция по монтажу

ES

Instrucciones de montaje

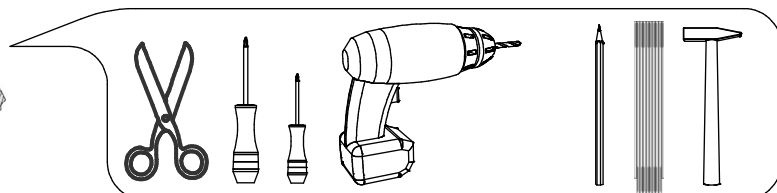
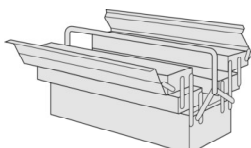
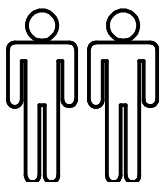

**IT****Avvisi di sicurezza**

Durante il montaggio del mobile, il triangolo segnala i seguenti avvisi.

**12**

Tenere lontano dai bambini pezzi di ferramenta come viti, copriviti ecc. per evitare un eventuale soffocamento.

**13**

Seguire scrupolosamente lo schema di montaggio.

**19**

Il montaggio deve essere effettuato da persolane qualificato. Se non viene effettuato correttamente, il prodotto può ribaltarsi o cadere, danneggiando persone o cose. Poiché ci sono pareti di materiali diversi, le viti per il fissaggio alla parete non sono incluse. Per scegliere gli accessori di fissaggio adatti, rivolgiti a un rivenditore locale.

**DE****Sicherheitshinweise**

Das Dreieck erinnert Sie während der Montage an die folgenden Hinweise.

**12**

Achten Sie darauf, daß Kinder keine Kleinteile, wie z. B. Muttern, Abdeckkappen oder Ähnliches in den Mund nehmen. Sie könnten sie verschlucken und daran ersticken.

**13**

Gehen Sie bei der Montage des Artikels sorgfältig vor und halten Sie sich an die Montageanleitung.

**19**

Fachkundige Montage erforderlich. Unsachgemäße Montage kann zu Unfällen führen. Da es viele verschiedene Wandmaterialien gibt, sind Schrauben für die Wandbefestigung nicht beigegepackt. Ggf. sollte man sich beim Eisenwarenfachhandel nach geeignetem Befestigungsmaterial erkundigen.

**UK****USA****Safety instructions**

The triangle reminds you during the installation of the following notes.

**12**

Ensure that children do not put any small parts such as nuts, caps or the like in their mouth. They could swallow and choke on them.

**13**

When assembling the product, please proceed with caution and comply with the assembly instructions.

**19**

Assembly should be carried out by a qualified person, because wrong assembly may lead to that the furniture will topple over and cause injury or damage. As wall materials vary, screws for fixing to wall are not included. For advice on suitable screw systems, contact your local specialised dealer.

**RU****Правила техники безопасности**

Во время монтажа треугольник служит напоминанием для следующих указаний.

**12**

Следите, чтобы мелкие детали, например гайки, крышки и т. п., не попали в рот ребенка. Дети могут их проглотить и задохнуться.

**13**

При монтаже изделия будьте внимательны и соблюдайте инструкции по монтажу.

**19**

Монтажът трябва да бъде извършен от специалист, тъй като неправилният монтаж може да доведе до прекатурване и да причини нараняване или повреда. Поради разнообразието от стени материали винтовете за прикрепяне към стената не са осигурени. Свържете се със специализиран доставчик за съвет относно подходящи прикрепващи механизми.

**CZ****Bezpečnostní pokyny**

Trojúhelník vám během montáže připomene následující pokyny.

**12**

Dbejte na to, aby děti nedávaly do úst žádné drobné díly jako např. matice, krytky a podobně. Mohly by je spolknout a udušit se.

**13**

Při montáži výrobku postupujte pečlivě a dodržujte pokyny uvedené v montážním návodu.

**19**

Montáž by měla být provedena kvalifikovanou osobou - nesprávné provedení může vést k převrhnutí nábytku a způsobit úraz nebo destrukci. Pro různé zdící materiály nejsou šroubky a uchycení obsaženy v balení. O vhodném připevnění se poraďte s odborným prodejcem.

**FR****Avis de sécurité**

Ces avis vous seront rappelés durant le montage par ce triangle.

**12**

Tenir éloignés les enfants pour éviter qu'ils ne mettent pas de petites pièces dans leur bouche, ils pourraient les avaler et étouffer.

**13**

Durant le montage de votre meuble veuillez procéder avec prudence et respecter les instructions de montage.

**19**

Le montage doit être effectué par une personne compétente. Un montage mal effectué peut provoquer la chute du meuble et blesser quelqu'un. Les vis et ferrures pour fixer le meuble au mur ne sont pas incluses. Choisissez des vis et ferrures adaptées au matériau de votre mur. En cas de doute, demandez conseil à un vendeur spécialisé.

## TR Güvenlik uyarıları

Durante a montagem do móvel, o triângulo indica as seguintes advertências.



12

Çocukların somun, muhafaza kapakçıkları ve benzeri küçük parçaları ağızlarına almamalarına dikkat ediniz. Bunları yutabilirler ve boğulabilirler.

13

Montaj esnasında büyük bir itinayla çalışınız, ürünle dikkatlice çalışınız ve mutlaka montaj talimatına uyunuz.

19

Montaj, yetkili bir kişi tarafından yapılmalıdır. Yanlış montaj mobilyanın düşmesine ve yaralanma veya hasara yol açabilir. Duvar yapı malzemeleri farklılık göstereceğinden duvar montajı vidaları dahil değildir. Uygun bir vida sistemi için ilgili araç-gerçeri satan dükkanlara başvurunuz.

## NL Veiligheidsinstructies

De driehoek herinnert u tijdens de installatie van de volgende meldingen.



12

Zorg ervoor dat kinderen geen kleine stukken, zoals moeren, afdekkapjes of dergelijke in de mond nemen. Ze kunnen ze inslikken en daardoor stikken.

13

Ga bij de montage van het artikel zorgvuldig te werk en houd u aan de handleiding voor de montage.

19

De montage dient te worden uitgevoerd door een vakbekwaam iemand. Foutieve montage kan ertoe leiden dat het meubel omvalt, waardoor er persoonlijk letsel of schade kan ontstaan. Omdat er veel verschillende wandmaterialen bestaan, zit er geen wandbeslag bijgesloten. Voor advies over geschikt wandbeslag, neem contact op met de vakhandel.

## RO Instrucțiuni referitoare la siguranță

Triunghiul vă atenționează să țineți cont în timpul montajului de următoarea indicație



12

Supravegheați copiii pentru că pot să introducă în gură piesele mici, cum ar fi de exemplu piulițe, capace sau altele similare. Ei pot să le înghită și se pot asfixia.

13

Procedați cu atenție la montarea produsului și respectați instrucțiunile de montaj.

19

Se recomandă ca montarea să fie realizată de o persoană calificată; asamblarea greșită poate determina desprinderea mobilierului, deteriorarea lui și chiar producerea de accidente. Întrucât materialele din care sunt construiți pereții variază, șuruburile pentru fixarea pe perete nu sunt incluse. Contactează dealer-ul tău local pentru consiliere.

## SK Bezpe č nostné pokyny

Trojuholník vám počas montáže pripomenie nasledujúce pokyny.



12

Dbajte, aby si deti nemohli dať do úst drobné diely, ako napr. matice, krytky alebo podobne. Mohli by ich prehltnúť a zadusili sa.

13

Pri montáži výrobku postupujte obozretne a dodržujte návod na montáž.

19

Pohišťvo naj sestavľva za to usposobljena oseba, saj se lahko nepravilno sestavljeno pohišťvo prevrne in povzroči telesne poškodbe ali materialno škodo. Ker se stenski materiali razlikujejo, vijaki niso priloženi. Za nasvet glede primerne vrste vijakov se obrnite na najbližjo specializirano trgovino.

## PL Wskazówki bezpieczeństwa

Trójkąt przypomina o następujących wskazówkach dotyczących montażu.



12

Należy dopilnować, aby dzieci nie bawiły się lub też brały do ust żadnych drobnych części mebla, takich jak np. nakrętki, zatyczki itp.. Mogłyby je połknąć i udusić się nimi.

13

Podczas montażu proszę postępować z należytą uwagą i zgodnie z instrukcją montażu. Artykuł może być montowany tylko przez osoby z odpowiednimi kwalifikacjami.

19

Montaż powinien być przeprowadzany przez wykwalifikowaną osobę, ponieważ złe zmontowanie może spowodować zniszczenie mebla lub może wyrządzić szkodę domownikom. Ponieważ w każdym pomieszczeniu ściany mogą być wykonane z innego materiału, komplet nie zawiera żadnych wkrętów ani umocowań. Aby zasięgnąć porady w kwestii wyboru odpowiednich wkrętów skontaktuj się z lokalnym sklepem specjalistycznym.

## HU Biztonságtechnikai

A háromszög a szerelés közben a következő utasításra emlékezteti.



12

Gondoskodjon arról, hogy a gyerekek ne vehessék a szájukba a kis alkatrészeket, pl. az anyákat, a fed kupakokat stb. Ezeket lenyelve megfulladhatnak.

13

Atermék összeszerelésekor körültekint en járjon el, és tartsa magát a szerelési útmutatóban foglaltakhoz.

19

Az összeszerelést ajánlatos képzett szakemberre bízni, mert a helytelen összeszerelés következtében a bútor felborulhat és sérülést okozhat. Mivel a fal anyaga lakásonként / otthononként eltérő lehet, a rögzítéshez szükséges csavarokat a csomag nem tartalmazza. A megfelelő csavar kiválasztásáért kérj tanácsot az áruházban a szakképzett személyzettől.

**PT**

## Avisos de segurança

Durante a montagem do móvel, o triângulo indica as seguintes advertências.

**12**

Mantenha longe do alcance das crianças todo o tipo de peças pequenas como parafusos e outras, para evitar o risco de sufocamento.

**13**

Siga escrupulosamente o esquema de montagem.

**19**

Montaje a realizar por montador autorizado, pues un montaje erróneo puede resultar en una caída del mueble, causando daños a personas o cosas. Como hay muchas clases de materiales de pared, no se incluye los tornillos de montaje. Para sugerencias sobre sistemas de colocación adecuados, ponte en contacto con tu especialista más cercano.

**ES**

## Avisos de seguridad

Durante el montaje del mueble, prestar atención al triángulo que informa sobre los siguientes avisos.

**12**

Mantener alejado de los niños piezas de herramientas como tornillos, ecc para evitar una eventual asfixia.

**13**

Seguir escrupulosamente el diagrama de montaje.

**19**

A montagem deverá ser realizada por uma pessoa qualificada, porque uma montagem incorrecta pode ocasionar que o móvel caia e cause lesões ou estragos. Como os materiais de parede variam, os parafusos para fixar à parede não estão incluídos. Para obter conselho sobre o sistema de parafusos adequado, consulte o seu retalhista local especializado.

**AR**

## إشعارات الأمان

من فضلك اتبع الخطوات التالية الموضحة أدناه لكيفية التركيب و المرموز لها بالمثلثات الصفراء أسفله

**12**

تأكد من ابعاد الأجزاء الصغيرة و المسامير و البراغي التي يمكن ابتلاعها من أيدي الأطفال

**13**

عند تجميع و تركيب المنتج يرجى اتباع الخطوات المنصوص عليها بدقة و حذر

**19**

من الأفضل الاستعانة بشخص مؤهل أو مختص في تركيب الأثاث لأن التركيب الخطأ قد ينتج عنه السقوط او التلف او الكسر و قد يسبب اصابات. كما أن المختص سوف يعرف تماماً نوع المسامير و البراغي المناسبة لأسطحكم والتي قد تكون غير متناسبة مع البراغي و المسامير المرفقة

# Service • Dienstverlening • Serwis • Servis • Сервисная служба • Servizio

Name • Naam • Nazwa • Isim • Название • Nom • Nome

Nr. • No. • Номер • Nu.

Тур • Туре • Тір • Тип • Тіро

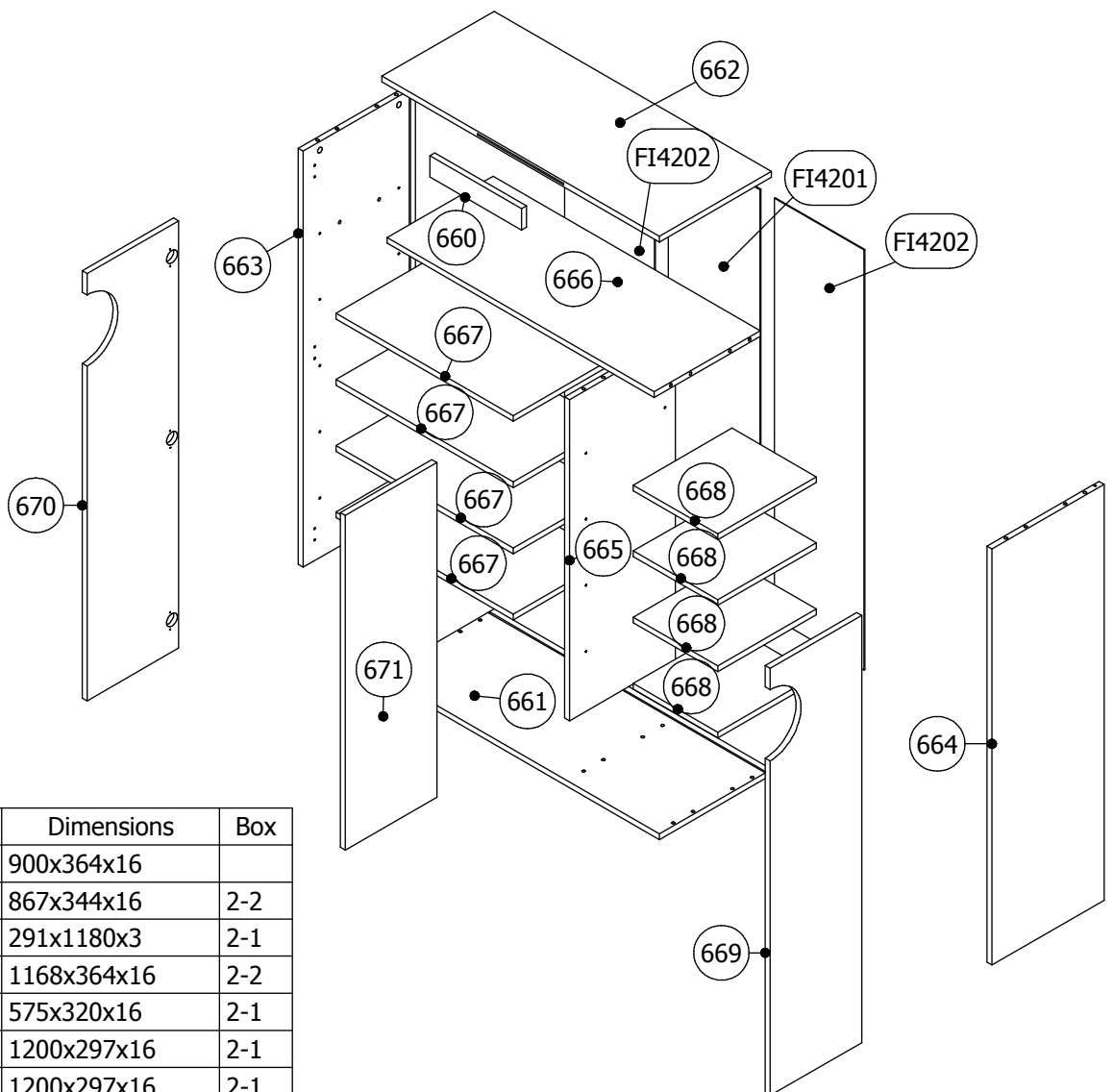
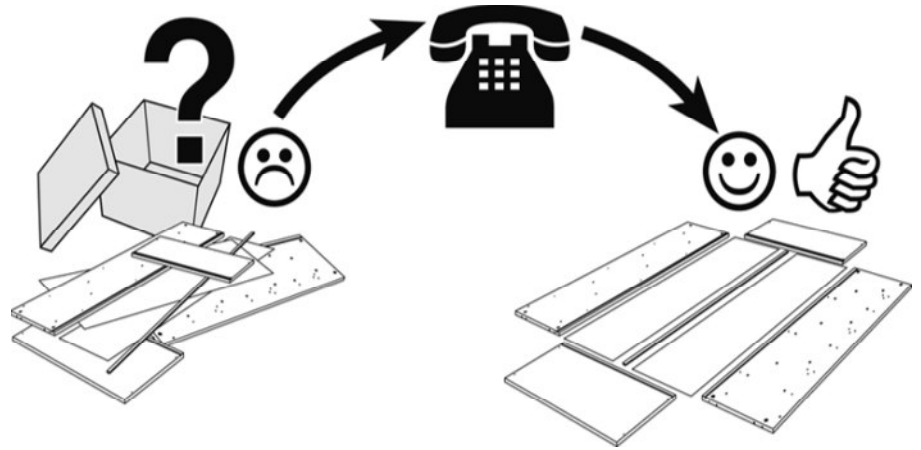

Code	Qt.	Dimensions	Box
661	1	900x364x16	
666	1	867x344x16	2-2
FI4202	2	291x1180x3	2-1
663	1	1168x364x16	2-2
667	4	575x320x16	2-1
669	1	1200x297x16	2-1
670	1	1200x297x16	2-1
664	1	1168x364x16	2-2
662	1	900x364x16	2-2
665	1	902x344x16	2-2
671	1	940x297x16	2-1
668	4	274x320x16	2-1
FI4201	1	1180x297x3	2-1
660	1	297x60x16	2-1

12

10 X FE2429



10 x FE9604

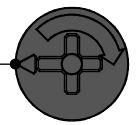

12 X FE9205A

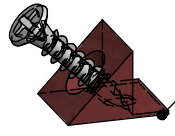

2 X 2623

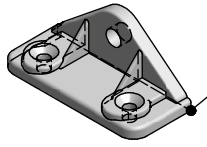

2 X LAM0001



32 X FE9218

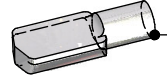

1 X FE9392

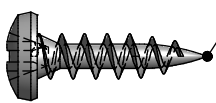

26 X FE9403

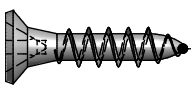

1 X FE9404

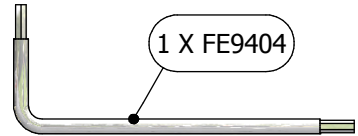

1 X FE2454

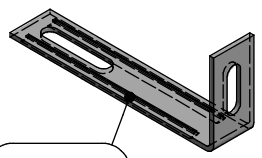

4 X FE9685

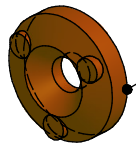

4 X FE9728



6 X FE9134

4 x FE9729

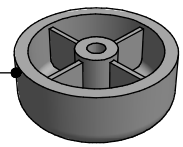

16 x SPL001



1 X CL0101

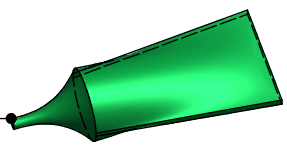

8 X FE2819

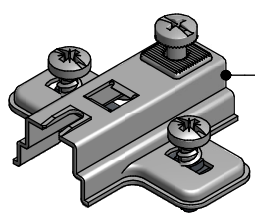

6 X FE9755

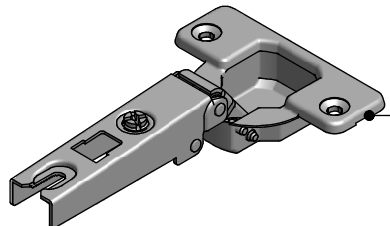

2 X FE9719

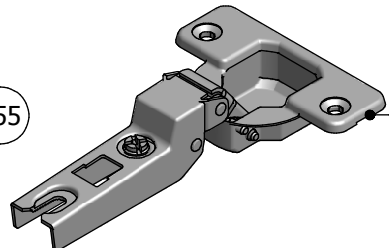

13

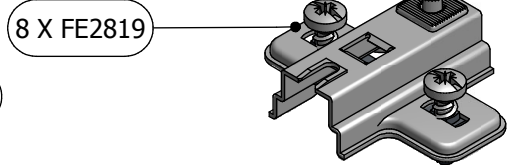
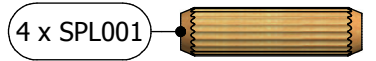
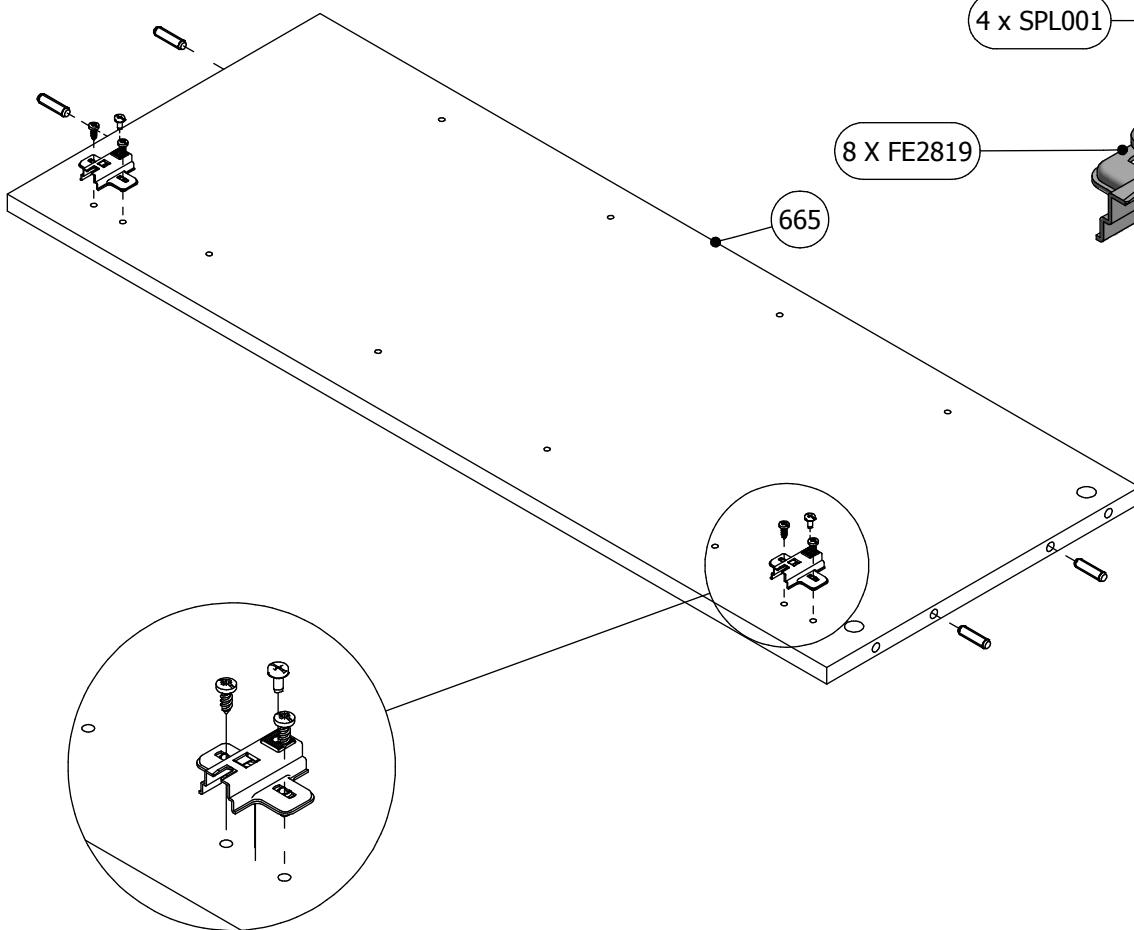
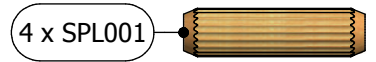
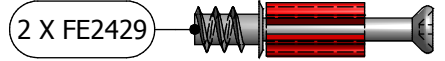
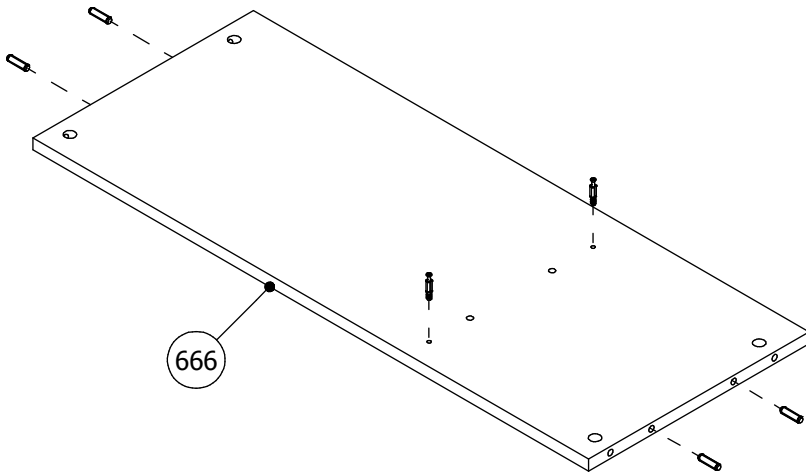
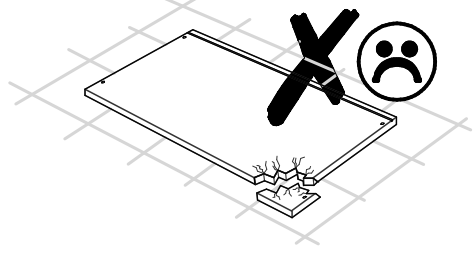
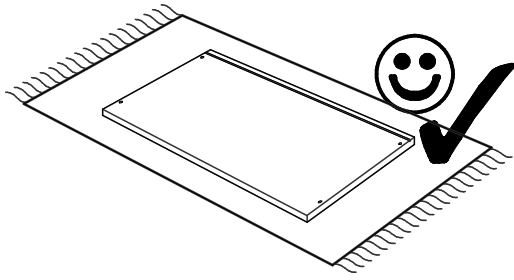

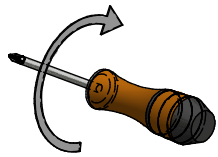

180°

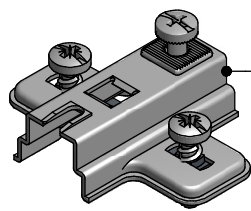
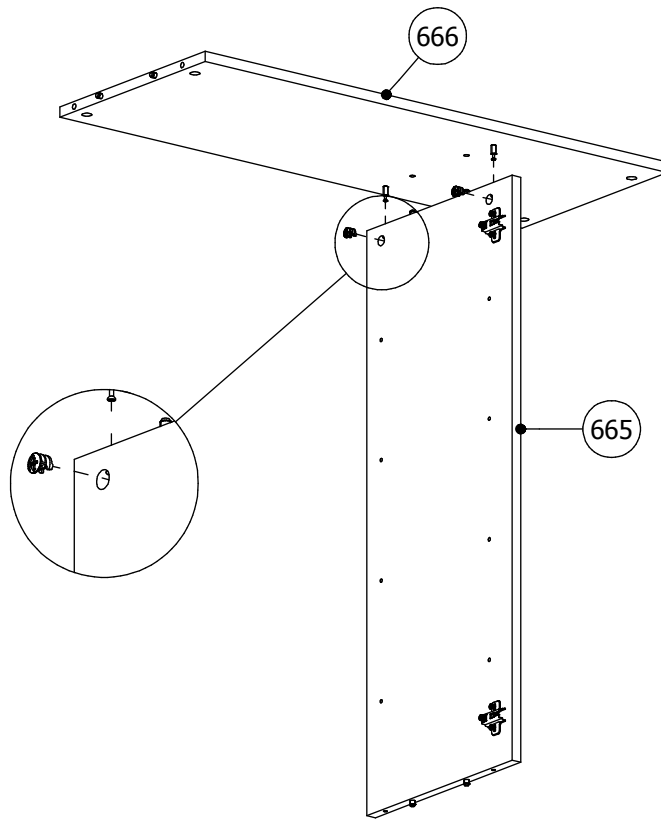
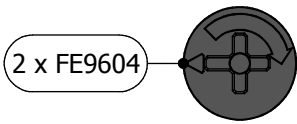

3 X FE2819

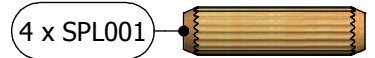

4 x SPL001

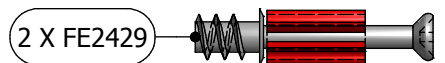

2 X FE2429

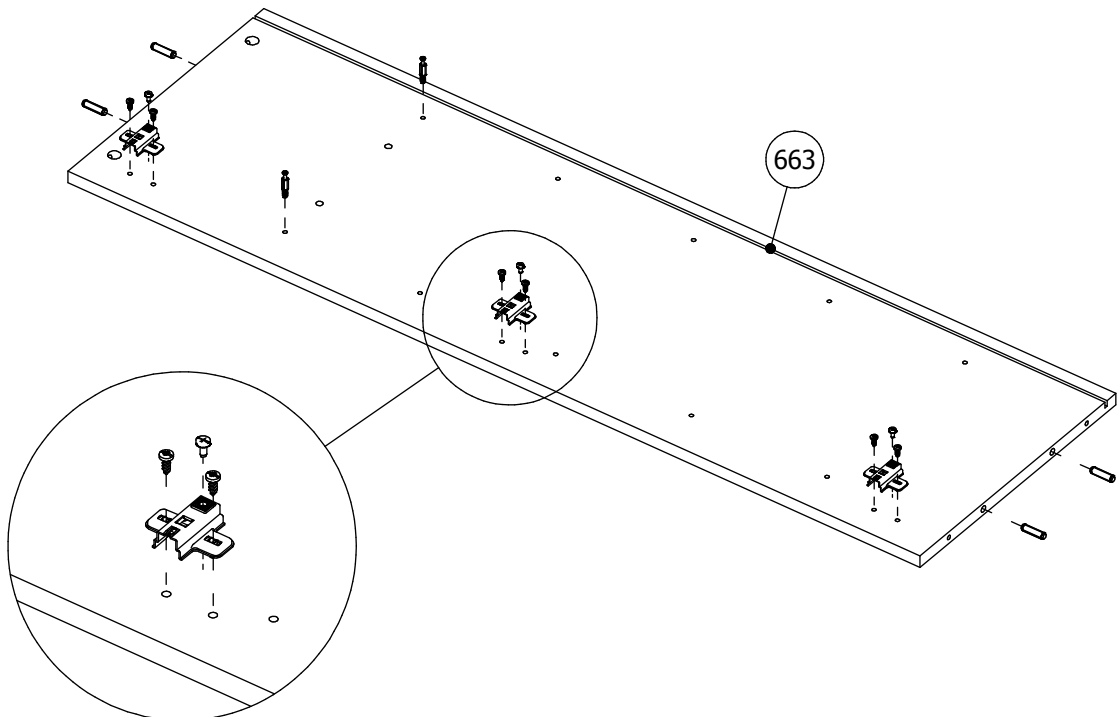



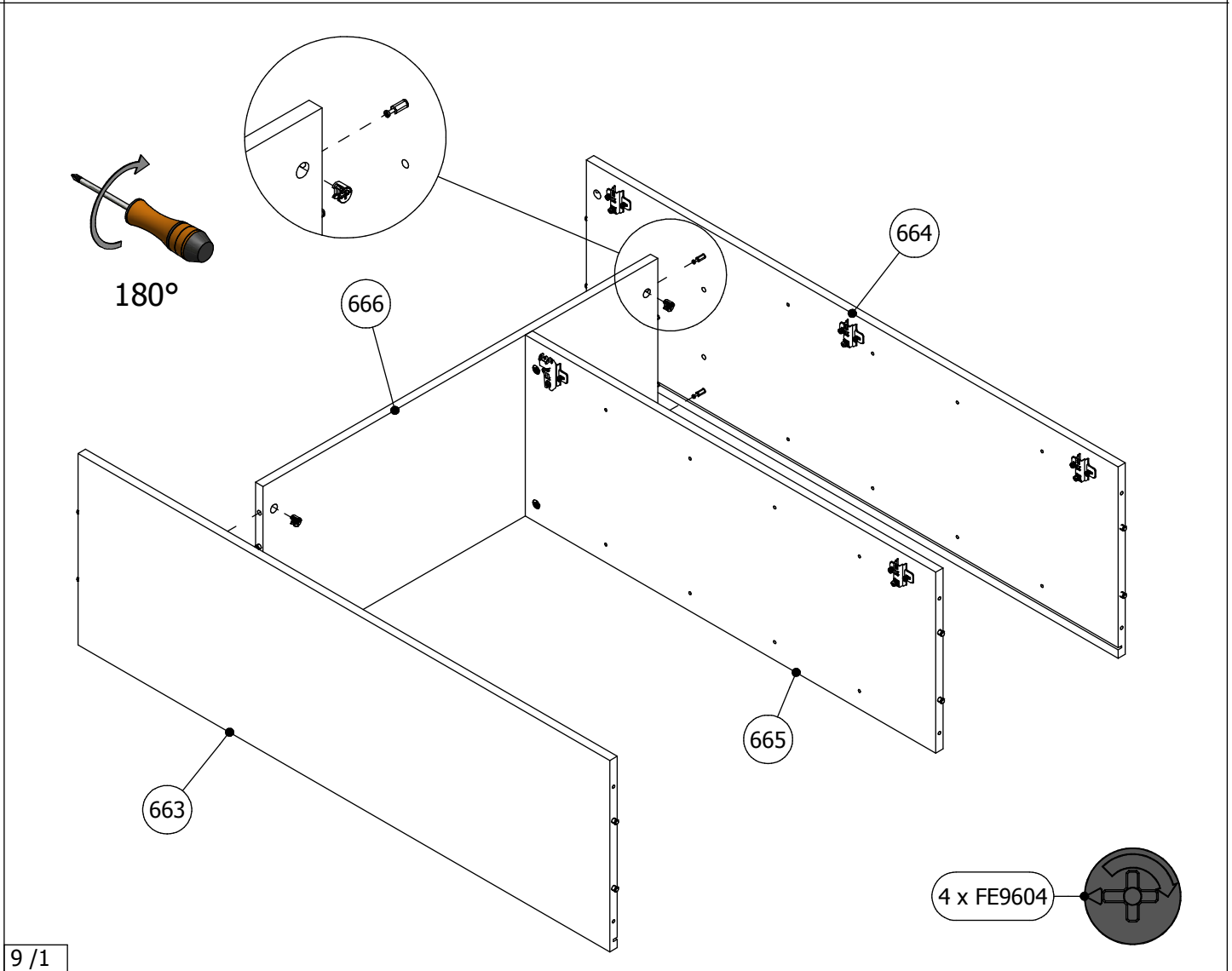
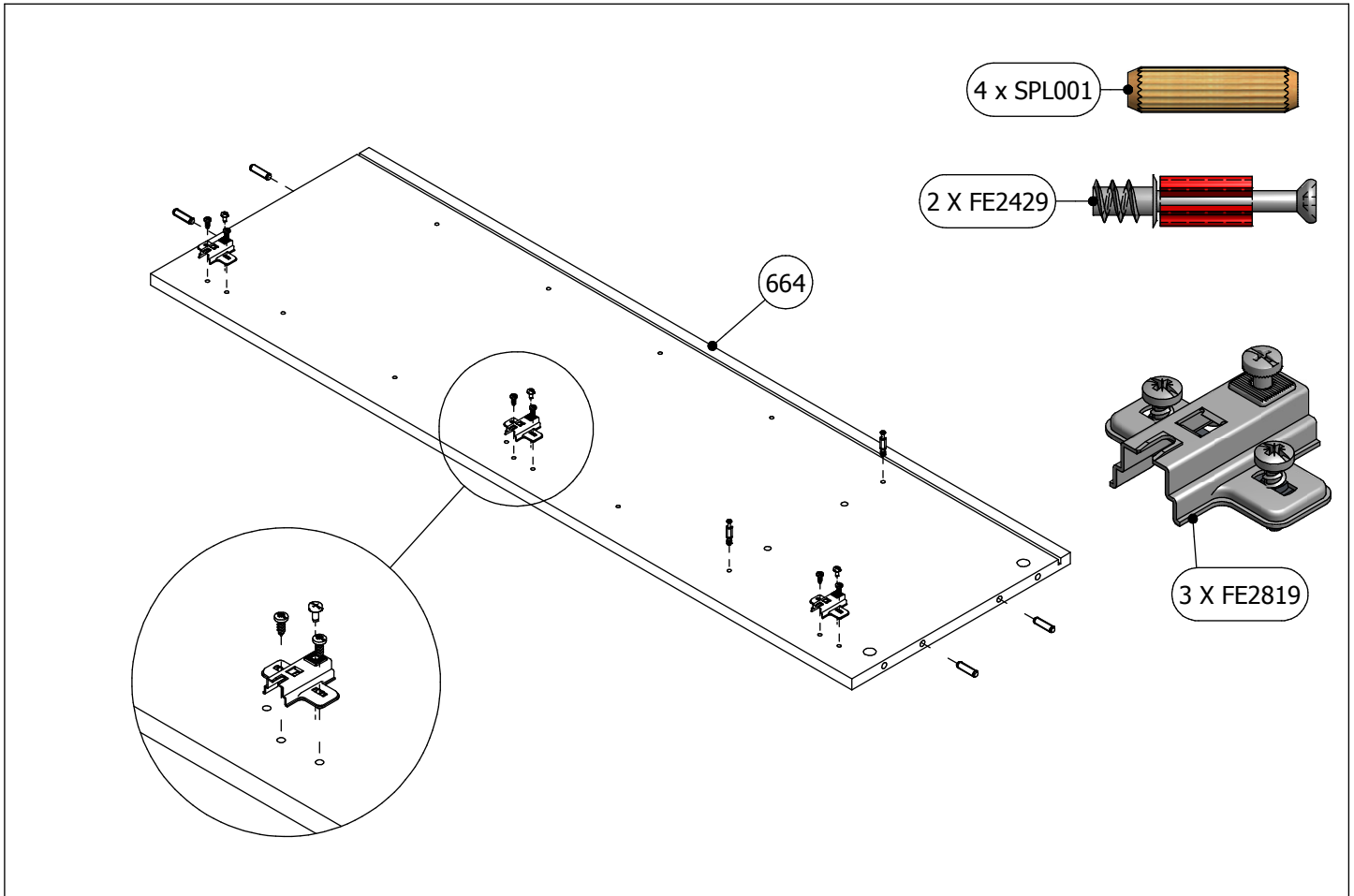

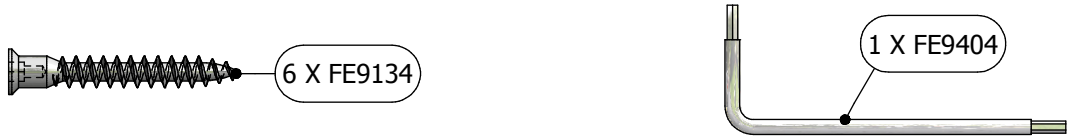
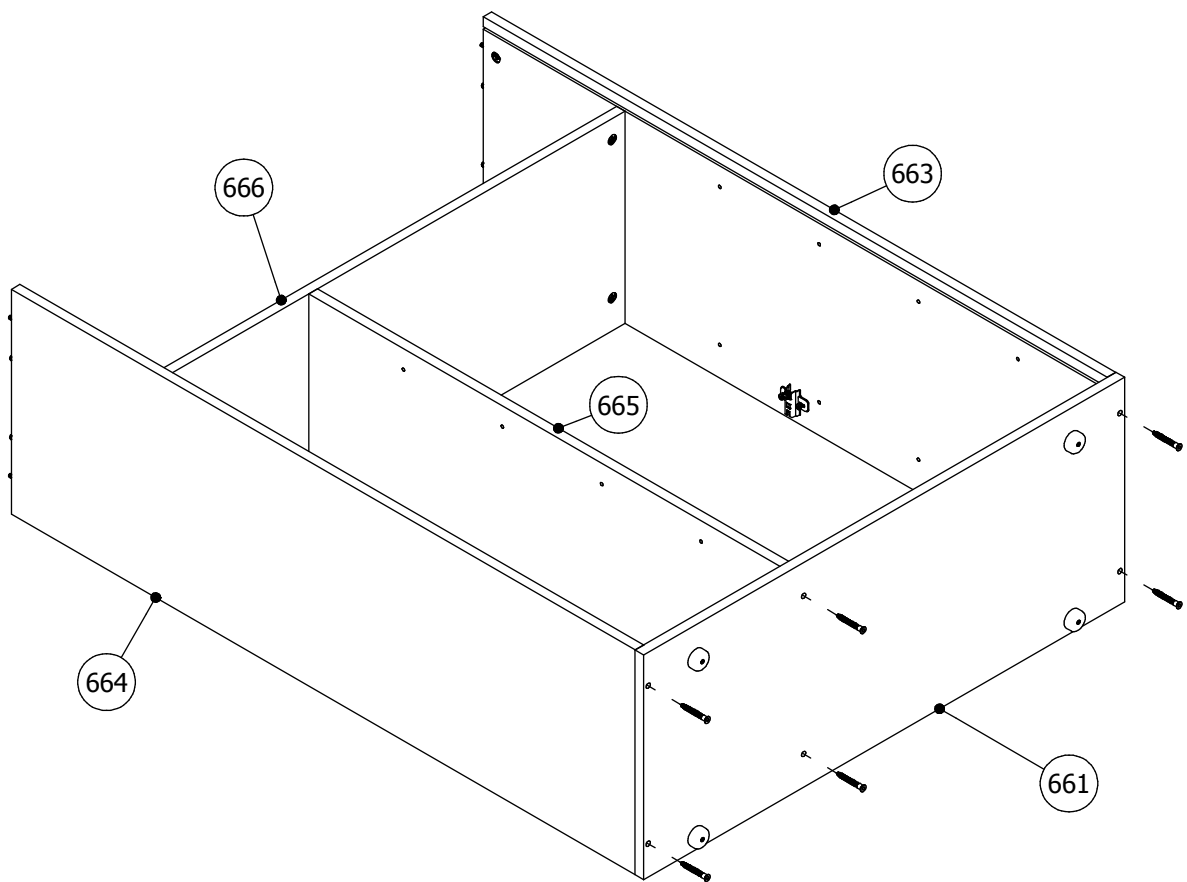
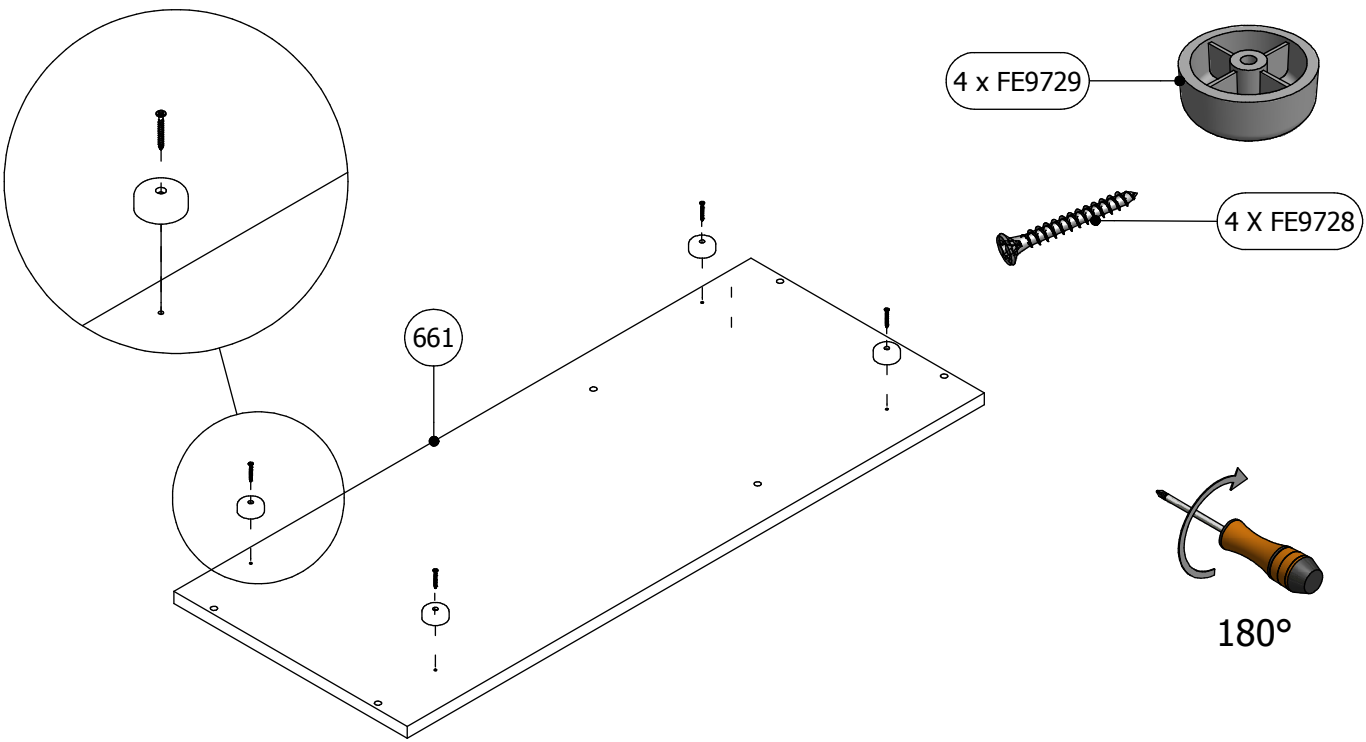

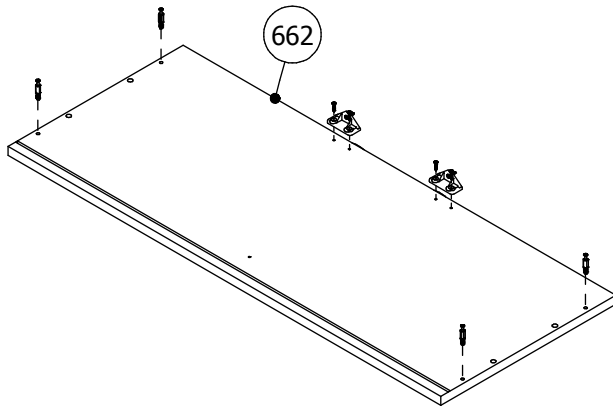

4 X FE2429



2 X 2623

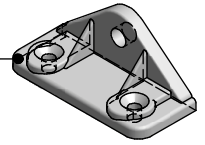

6 X FE9403

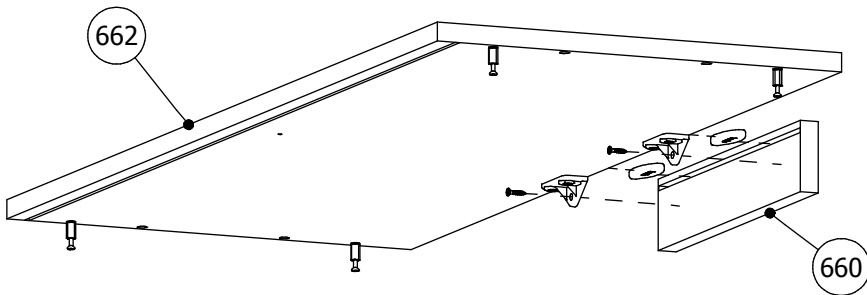
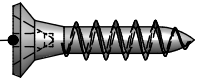

2 X LAM0001



CL0101

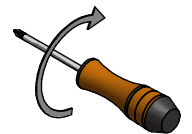
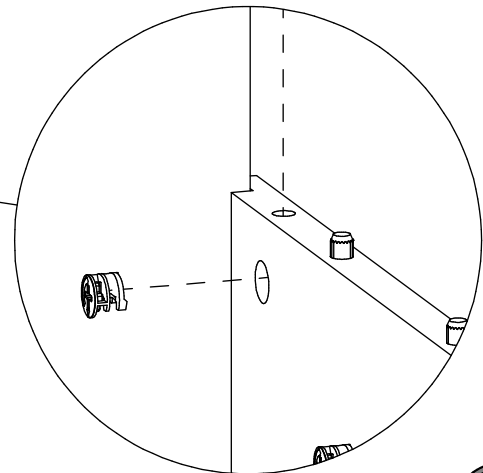
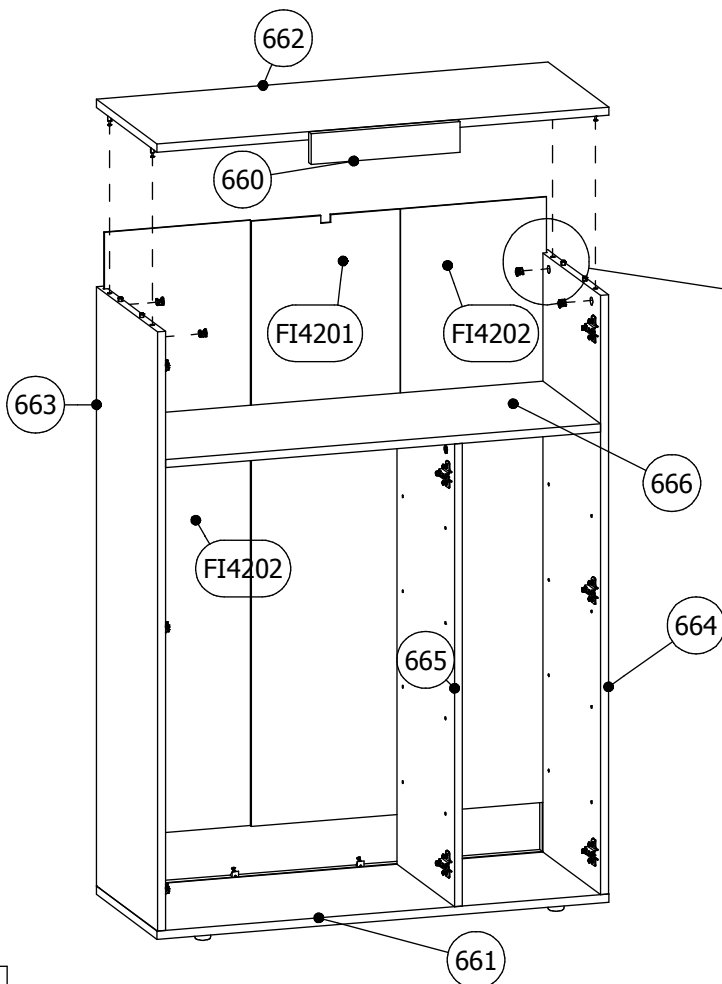

180°

4 x FE9604

