

Inge 1

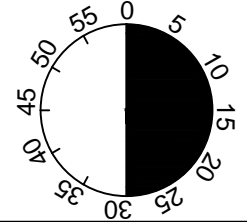
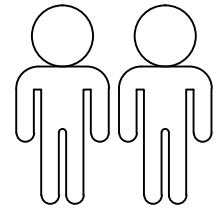
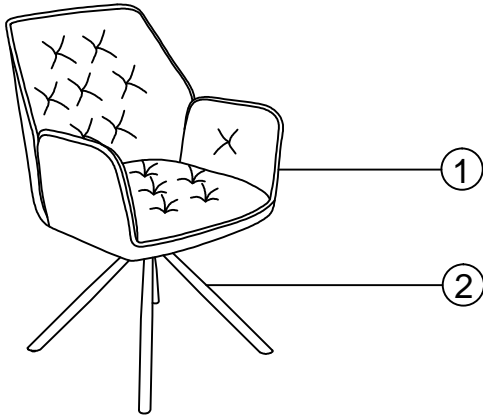

1

2

3

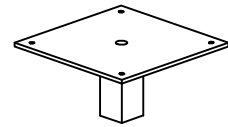
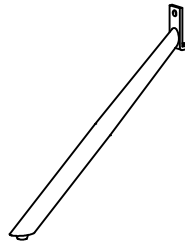
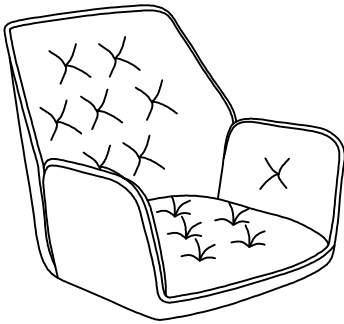



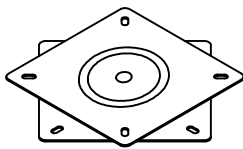

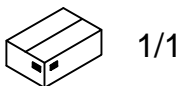

4



1	1x
2	4x
3	1x
4	1x

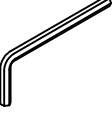
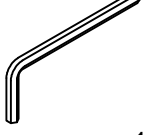





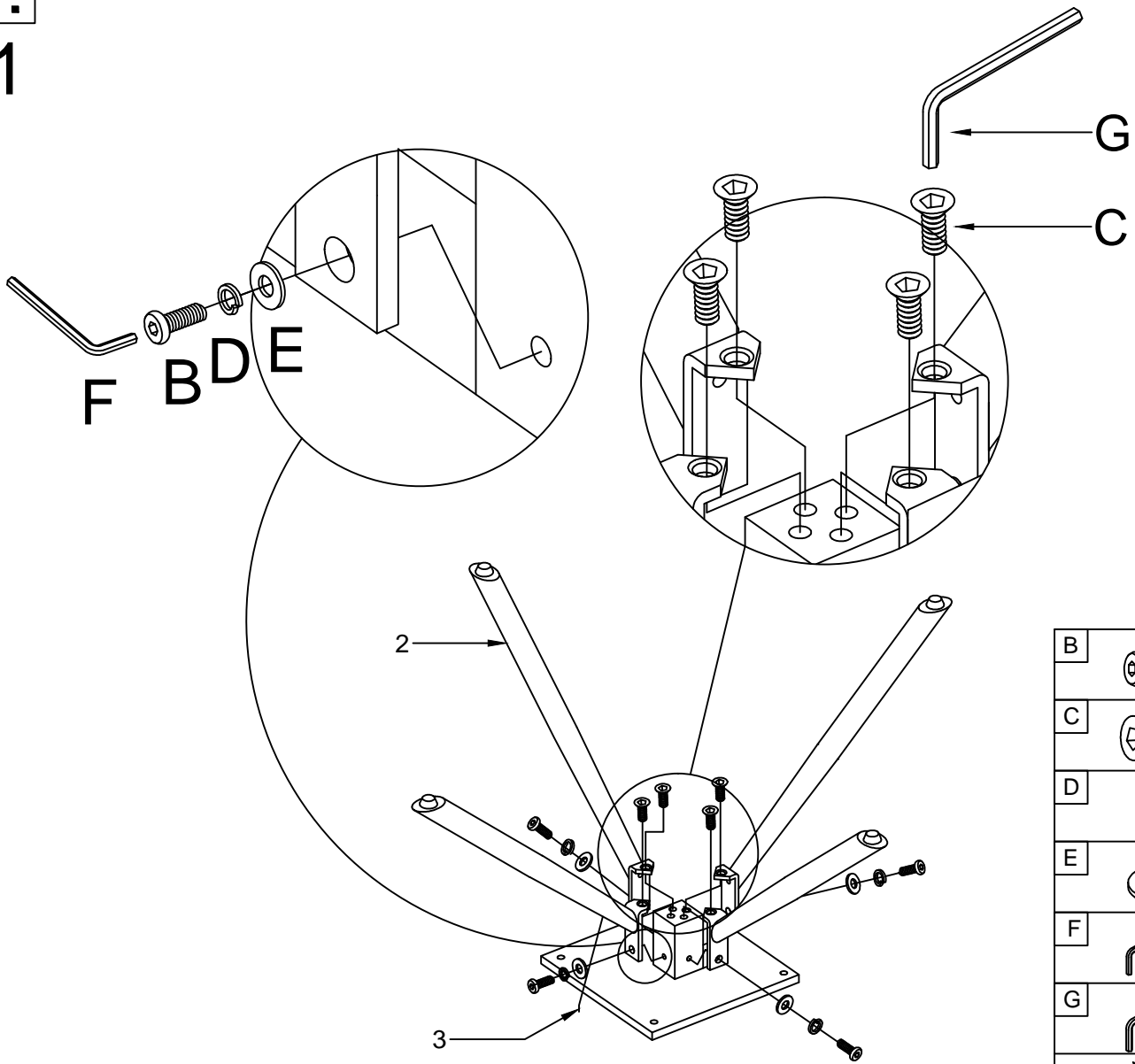

A	M6X10	B	M6X20	C	M8X16	D	M6	E	Ø18xØ6x1.5	F	4MM
											
	4x		8x		4x		4x		12x		1x
G	5MM	H	Ø17xØ6.5x4								
											
	1x		2x								

I.





1

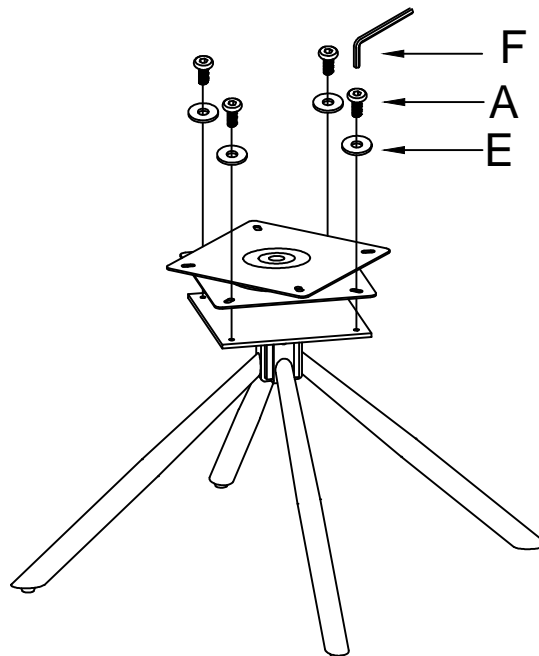

B		M6x20 4x
C		M8x16 4x
D		M6 4x
E		Ø18xØ6x1.5 4x
F		4MM 1x
G		5MM 1x
		

2



A		M6x10 4x
E		Ø18xØ6x1.5 4x
F		4MM 1x
		

II.

3

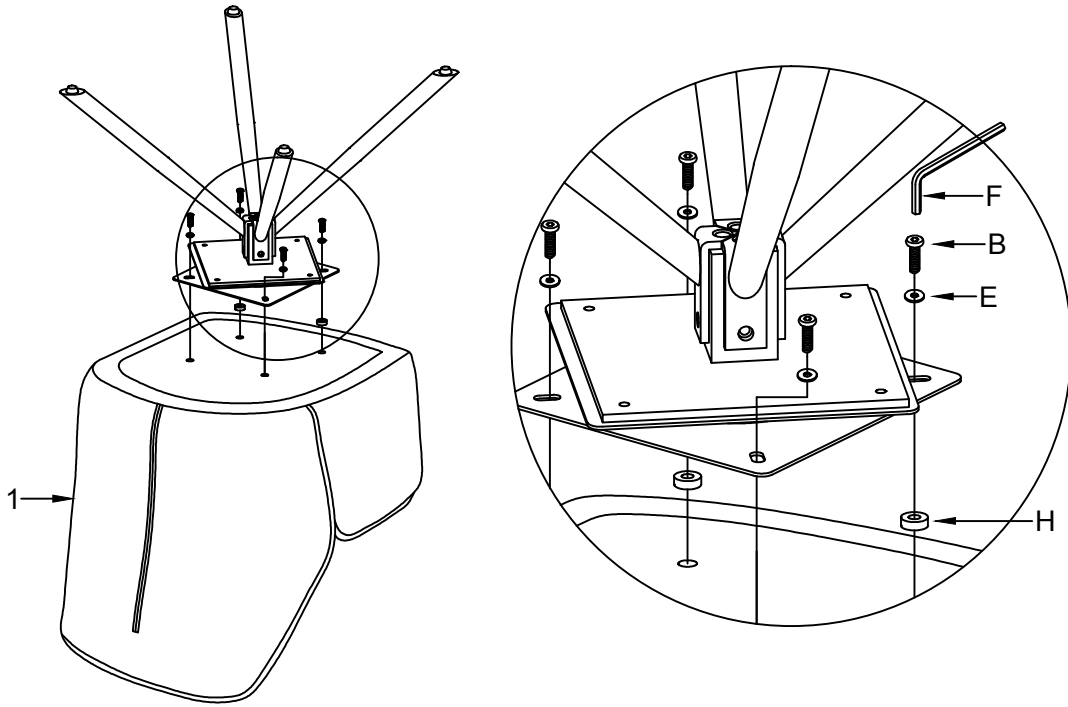

B	M6X20
	4x
E	Ø18xØ6x1.5
	4x
F	4MM
	1x
H	Ø17xØ6.5x4
	2x

4

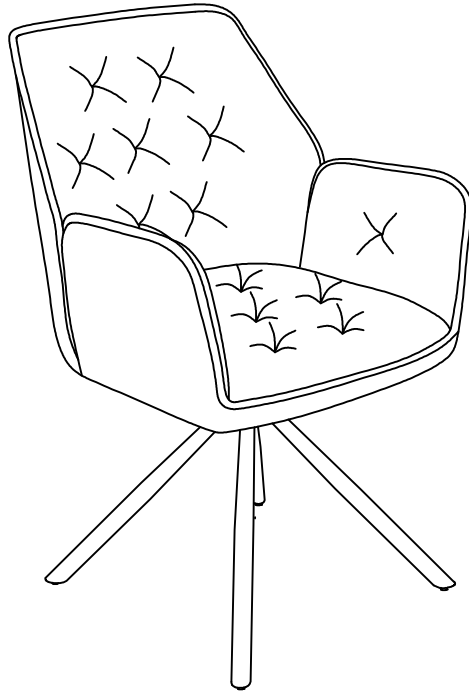

F	4MM
	1x



LE TRI
+ FACILE



Séparez les éléments avant de trier