

D Montageanleitung

GB Assembly instructions

FR Notice de montage

IT Istruzioni di montaggio

NL Handleiding voor de montage

PL Instrukcja montażu

CZ Montážní návod

SK Návod na montáž

HU Szerelési útmutató

RO Instrucțiuni de montaj

TR Montaj talimatı

RU Инструкция по монтажу

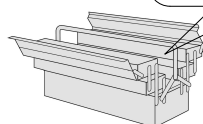
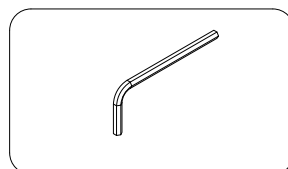
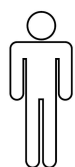

Service • Assistent • Dienstverlening • Serwis
 Servis • Szerviz • Сервисная служба

Name • Nom •
 Nome • Naam •
 Nazwa • Jméno •
 Názov • Név •
 Denumire • Isim •
 Название

Nr. • No. • N° •
 Номер • Č • Sz

Typ • Type • Tip •
 Típus • Tipo
 Тип

8106 4320 2008 6463
 2797 2360 4701 5035

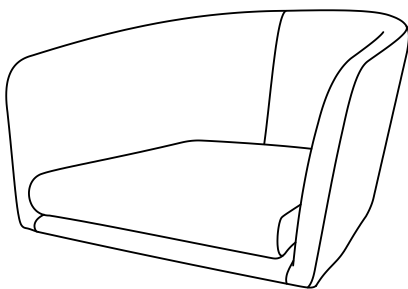
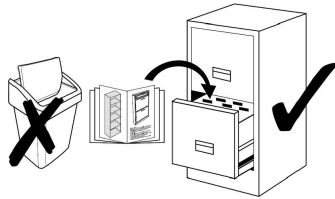
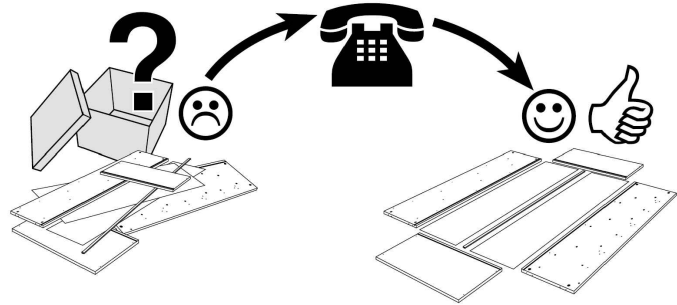

① 1X

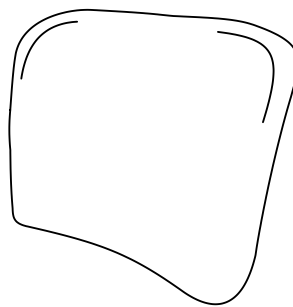

② 1X

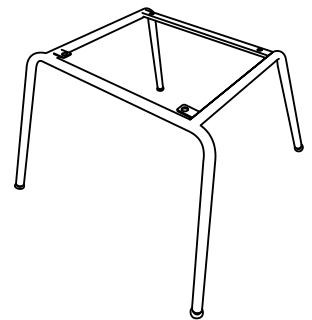

③ 1X

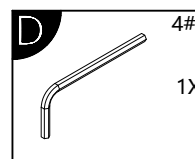
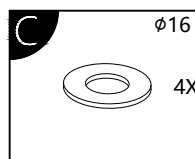
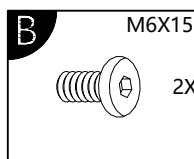
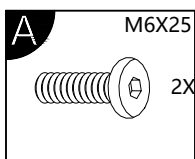

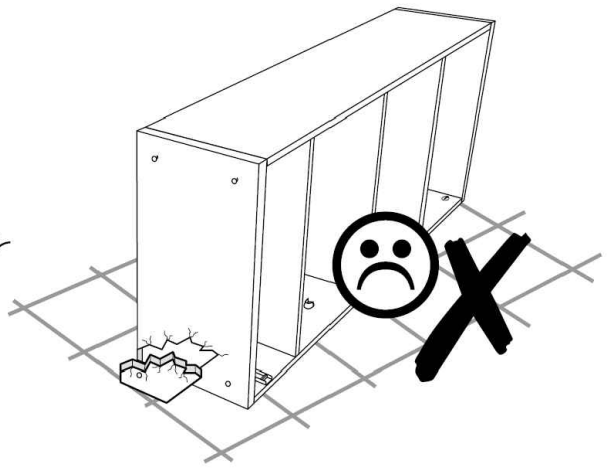
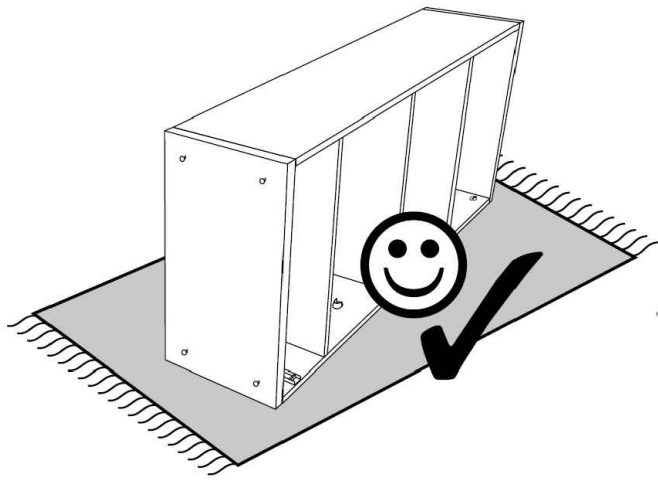

1

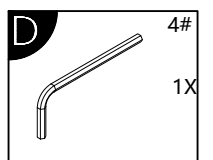
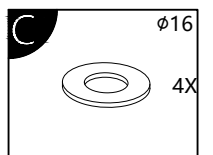
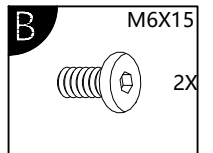
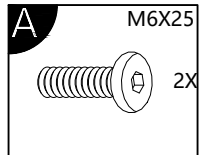
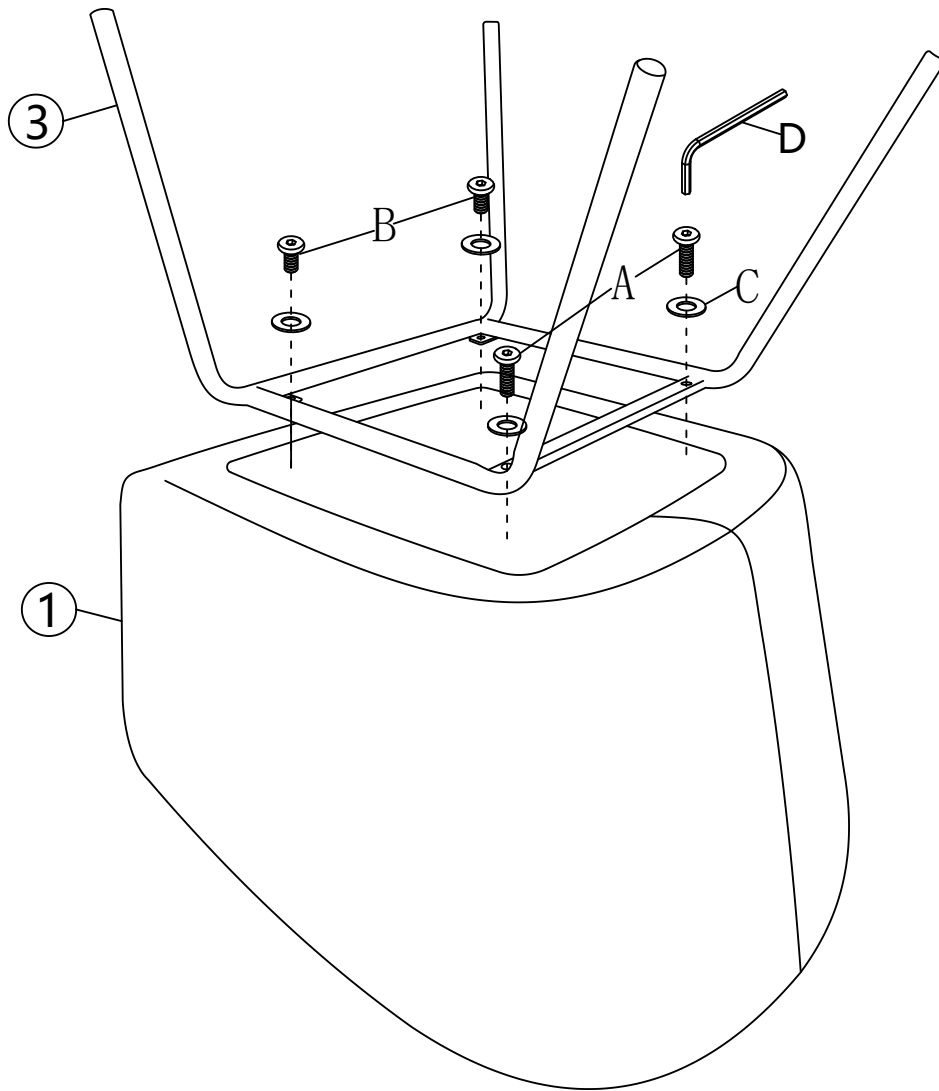

2

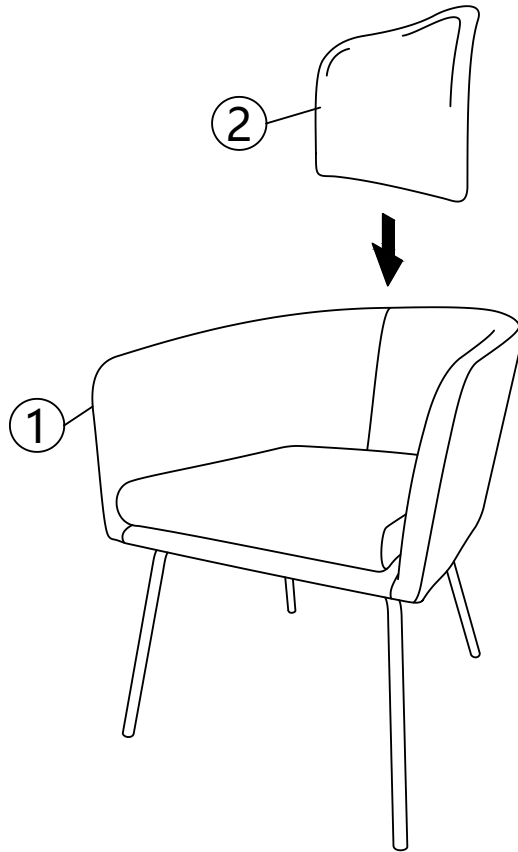

3

