

“3415”

versionsnummer: 16.12.2023

Naturholz kann sich werkstoffbedingt verziehen. Durch das Montieren ziehen sich Teile wieder plan.

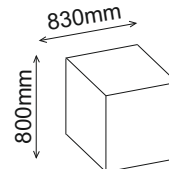
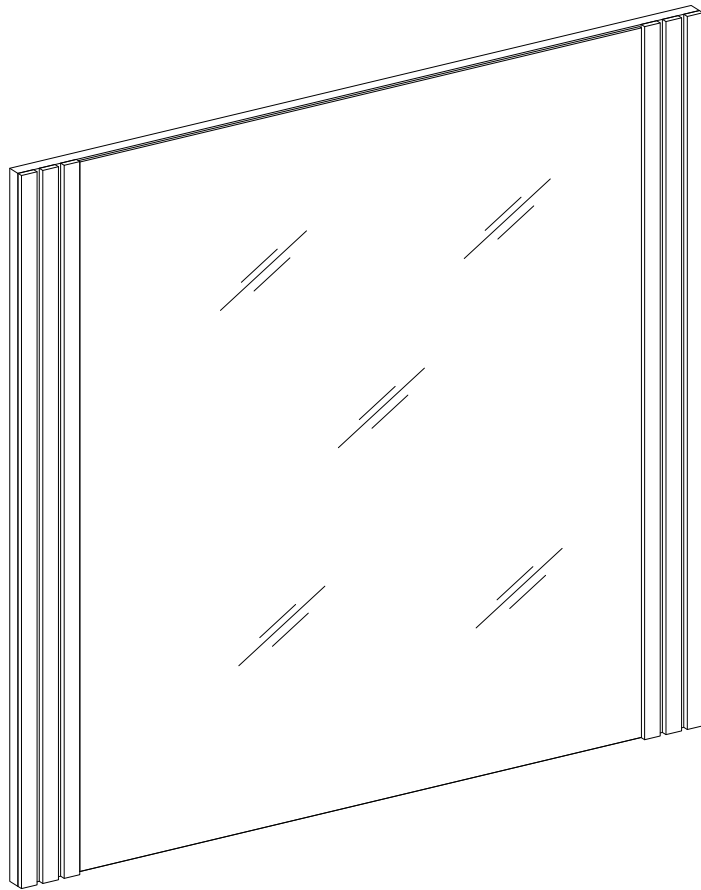
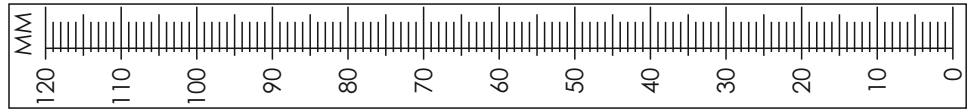

B1

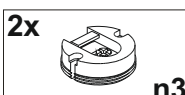
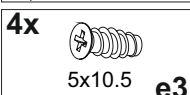
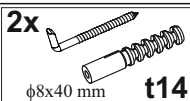

1

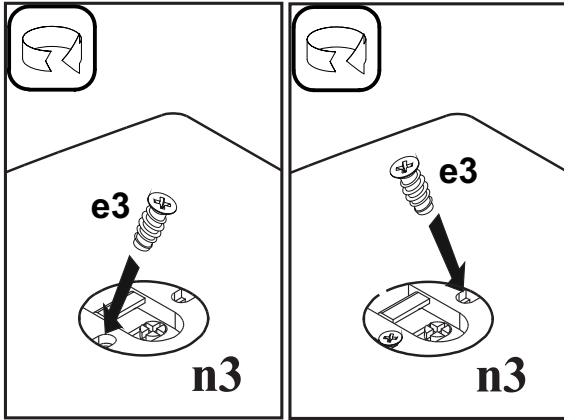

4x
5x10.5 e3

2x
n3

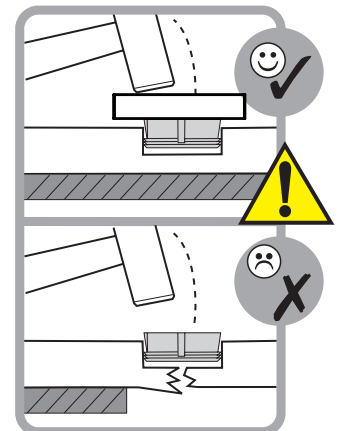
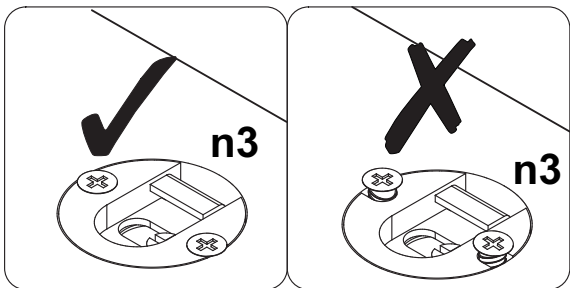
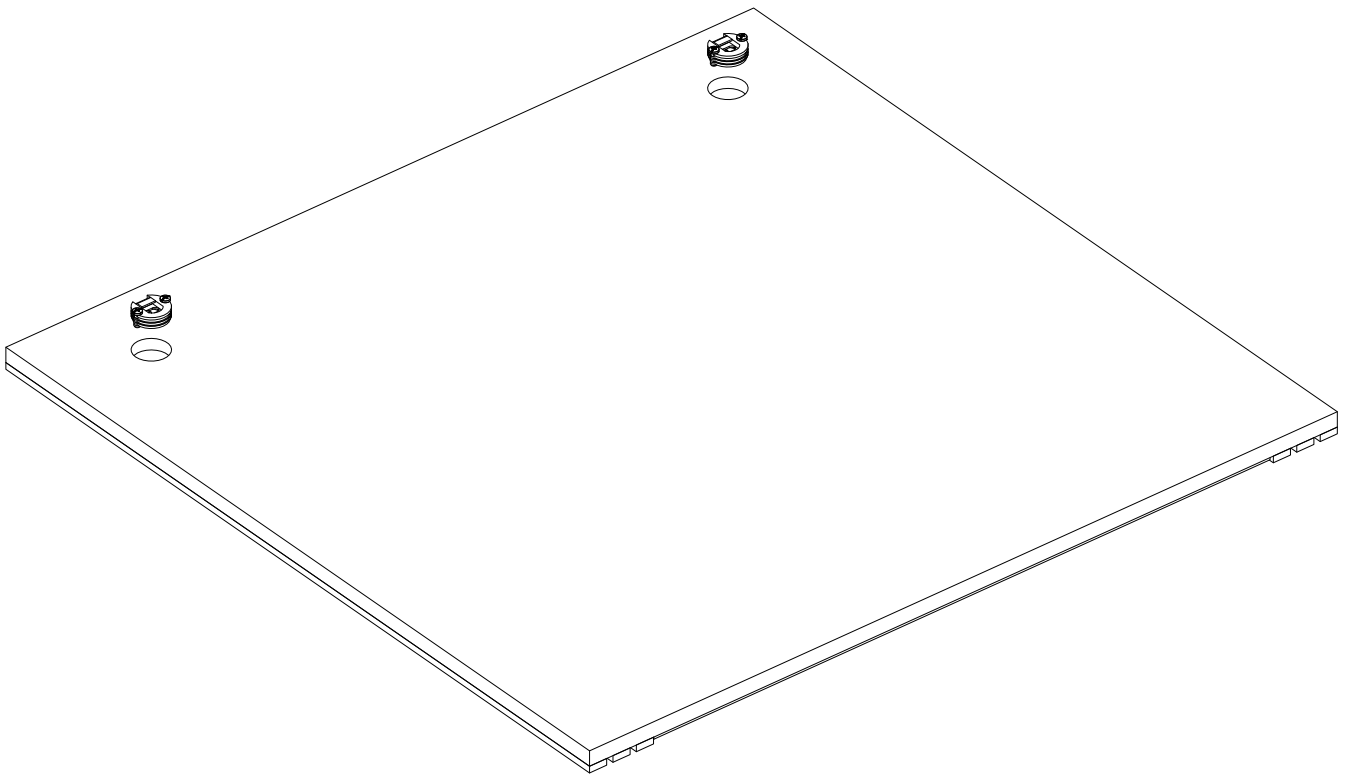

2

2

x2
φ8x40 mm t14

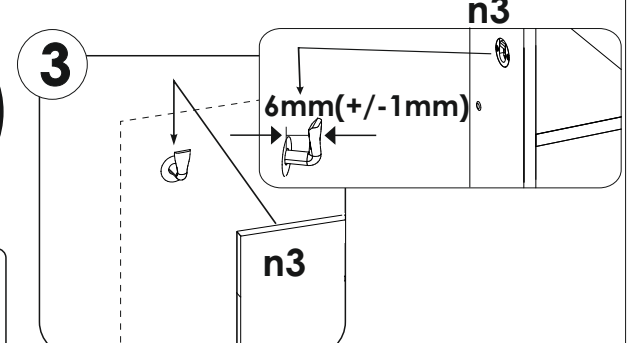
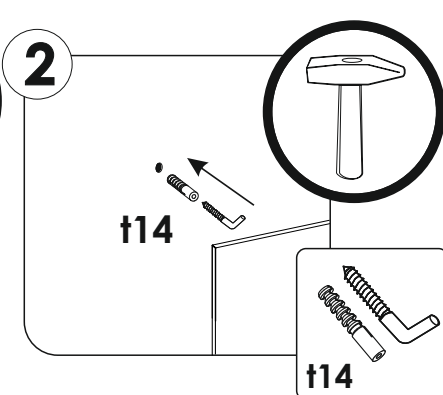
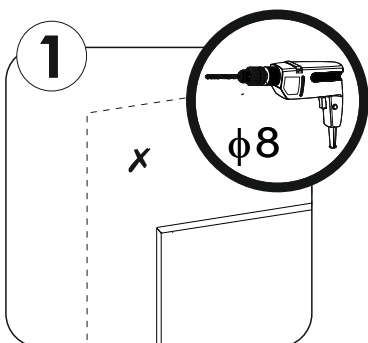
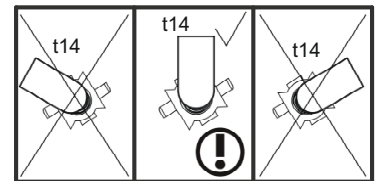
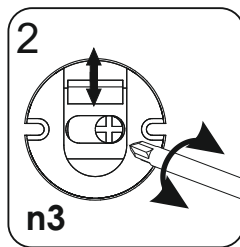
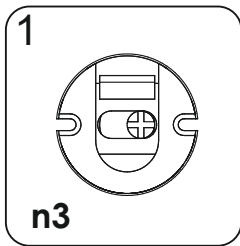
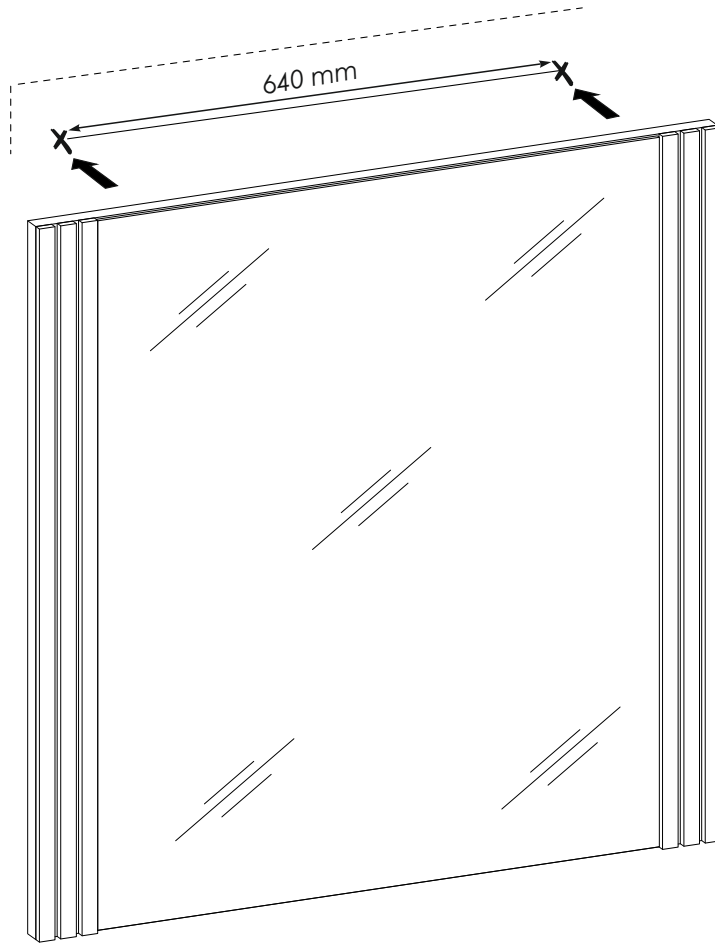
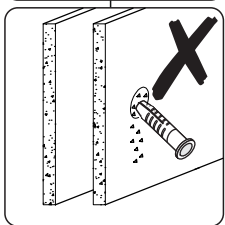
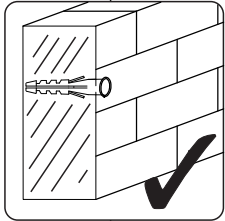
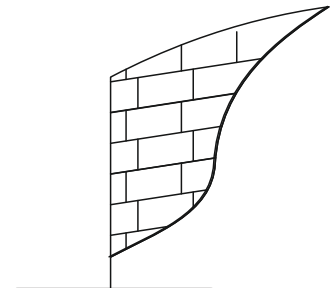

3