

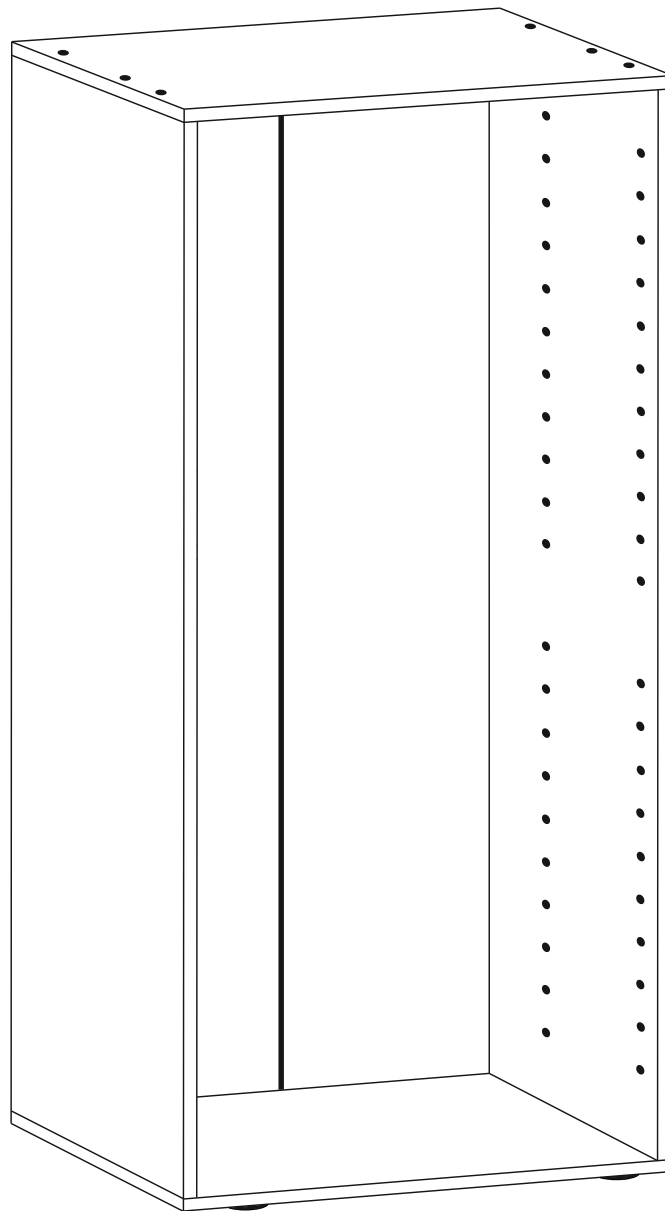

VCM Korpus "Vandol"

1,80m/ 0,71m/ 0,37m



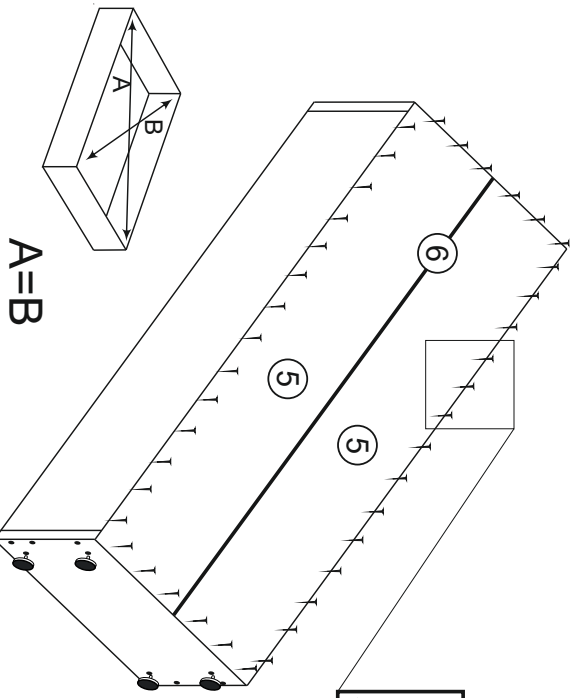

Achtung: Bei mangelhafter Montage besteht Gefahr für die Sicherheit.
Mebel unbedingt an der Wand montieren!!!!

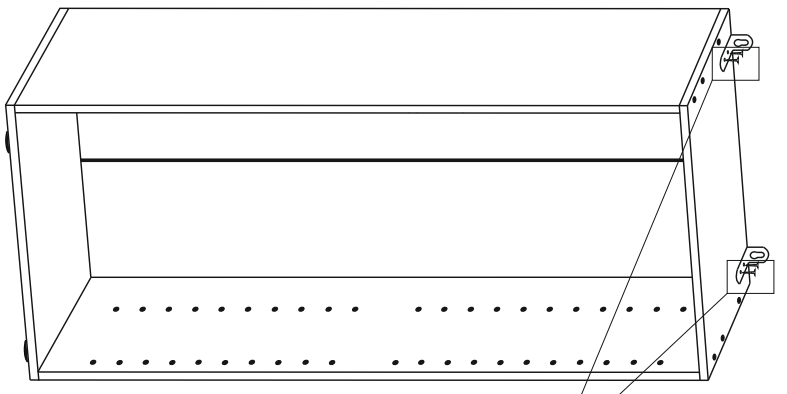
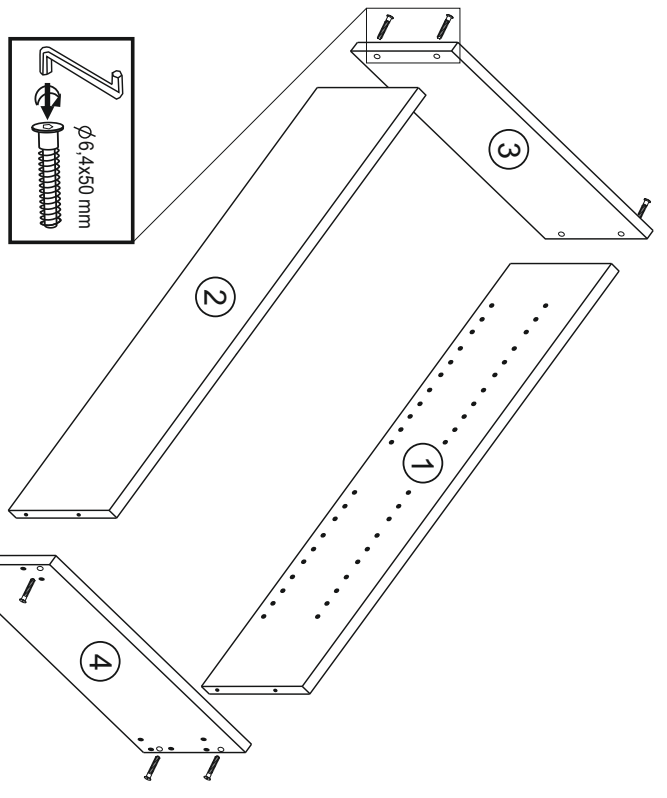

A=B

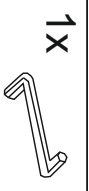
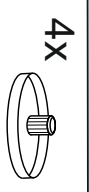
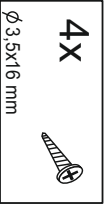
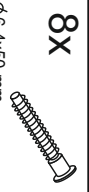
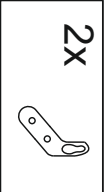

1,2	1764x370x16	1
3,4	702x370x16	1
5,5	1794x348	1
6	L-1764mm	1

- 
1x
- 
4x
- 
4x
 $\phi 3,5 \times 16$ mm
- 
8x
 $\phi 6,4 \times 50$ mm
- 
2x
- 
8x

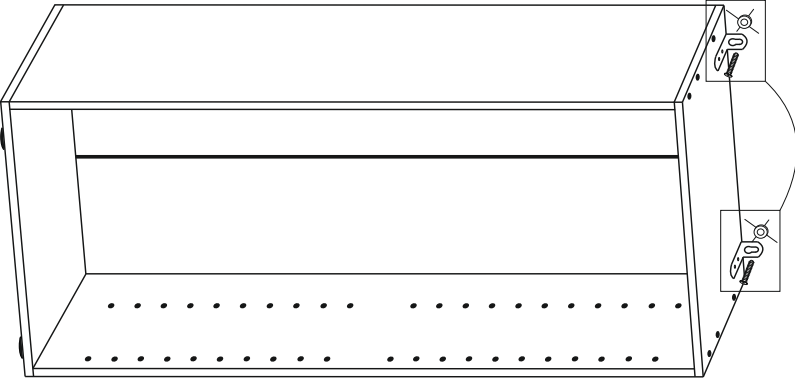
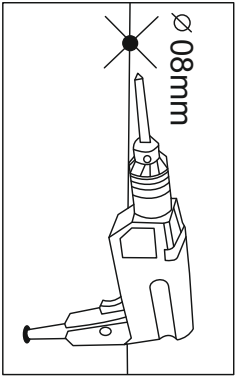
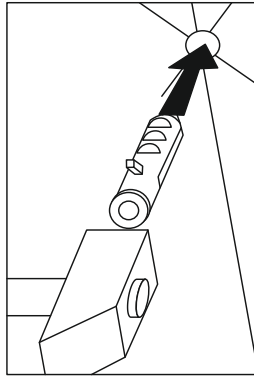
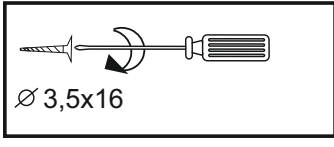
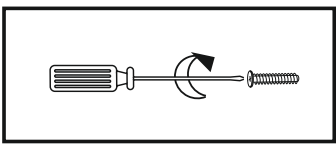



VCM Fachböden-Satz "Vandol I"

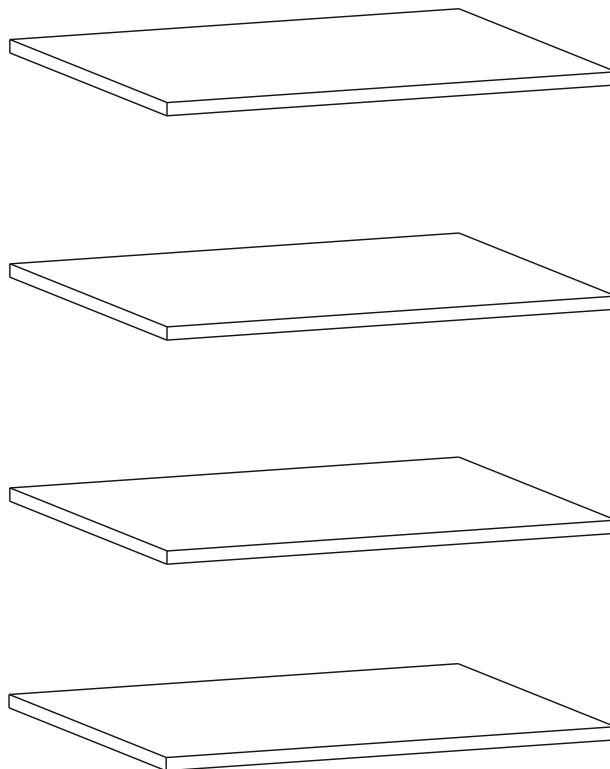

**Achtung: Bei mangelhafter Montage besteht Gefahr für die Sicherheit.
Mebel unbedingt an der Wand montieren!!!!**

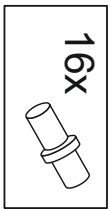
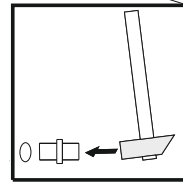
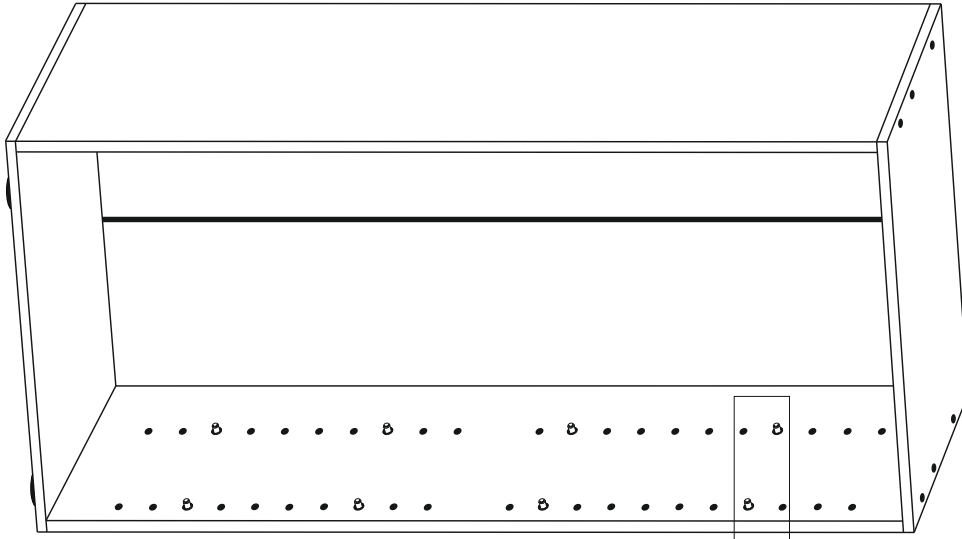

1-4x 668x365x16 3A

