

SCARLETT V

8141-0064/2503-0064
2501-0064/8142-0064

B/F

191001

- | | | | |
|-----------|--|-----------|---|
| D | MONTAGEANLEITUNG
BEDIENUNGSANLEITUNG | GB | ASSEMBLY INSTRUCTIONS
INSTRUCTION MANUAL |
| NL | HANDLEIDING VOOR DE MONTAGE
GEBRUIKSAANWIJZING | PL | INSTRUKCJA MONTAŻU
INSTRUKCJA OBSŁUGI |
| TR | MONTAJ TALIMATI
KULLANIM KLAVUZU | RU | ИНСТРУКЦИЯ ПО МОНТАЖУ
ИНСТРУКЦИЯ ПО ЭКСПЛУАТАЦИИ |
| RO | INSTRUCȚIUNI DE INSTALARE
INSTRUCȚIUNI DE UTILIZARE | IT | ISTRUZIONI DI MONTAGGIO
MANUALE DI ISTRUZIONI |
| FR | NOTICE DE MONTAGE
MANUEL INSTRUCTIONS | SK | MONTÁŽNY NÁVOD
NÁVOD NA POUŽITIE |
| HU | KÖZGYŰLÉS UTASÍTÁSOK
KEZELÉSI UTASÍTÁS | CZ | MONTÁŽNÍ NÁVOD
NÁVOD K POUŽITÍ |
| SI | NAVODILA ZA MONTAŽO
NAVODILA ZA UPORABO | PT | INSTRUÇÕES DE MONTAGEM
MANUAL DO USUÁRIO |
| ES | INSTRUCCIONES DE MONTAJE
MANUAL DEL USUARIO | HR | UPUTE ZA MONTAŽU
UPUTE ZA UPOTREBU |

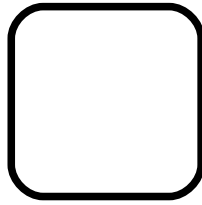
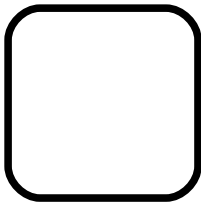

0019

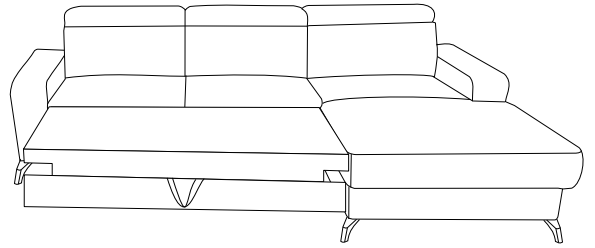
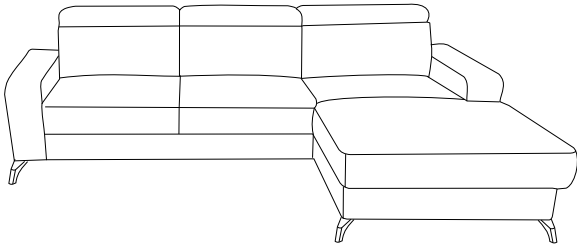

0019

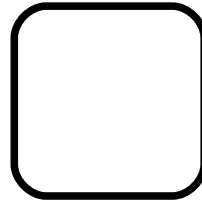
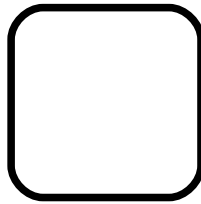

0089

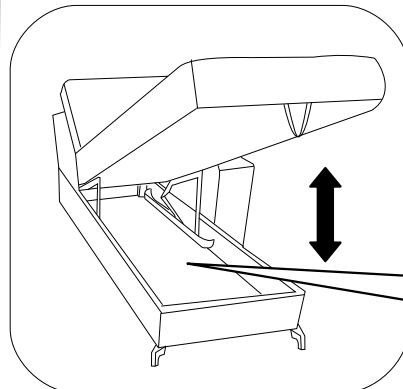
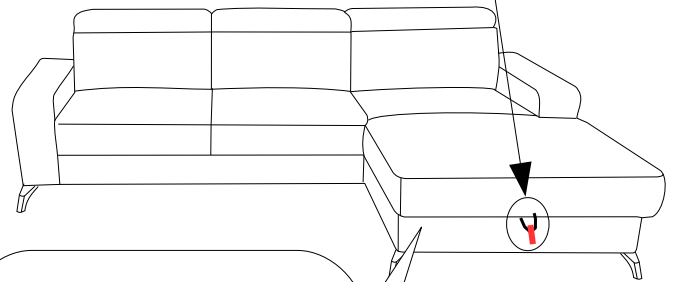
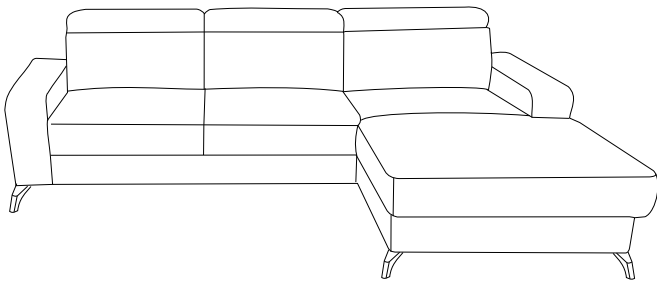
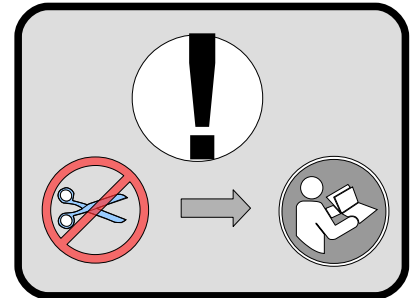

L

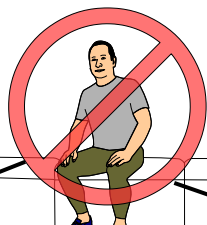

R

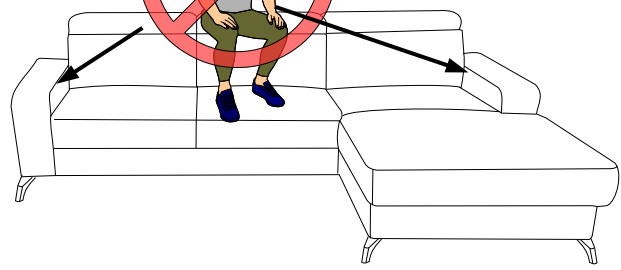
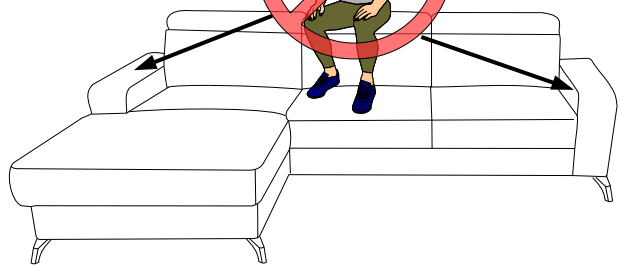
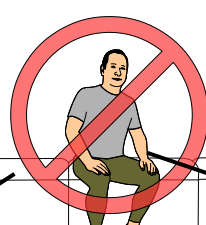



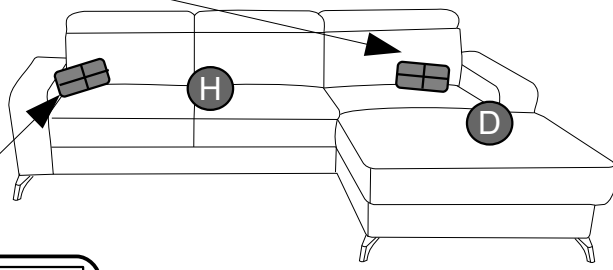
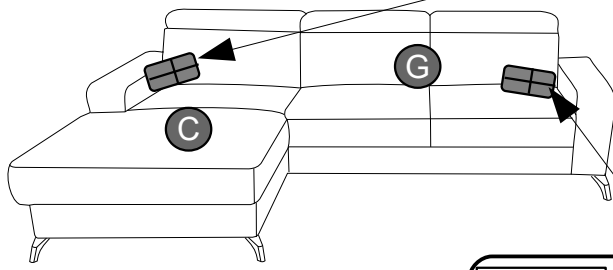
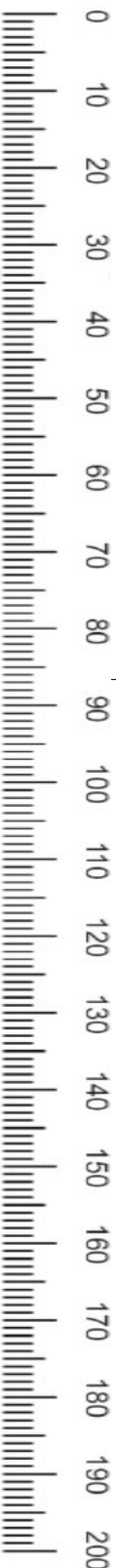

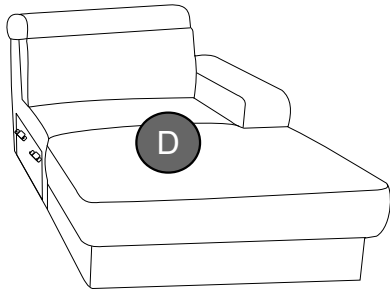
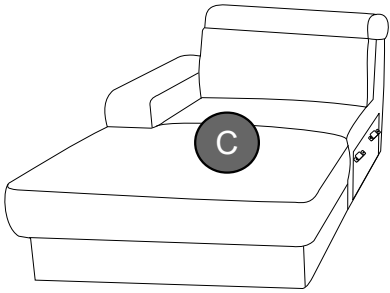
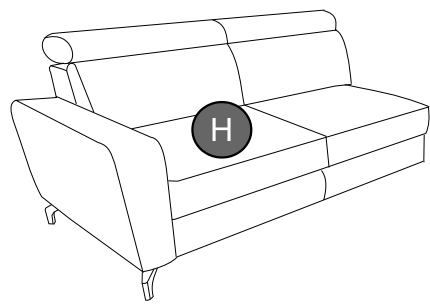
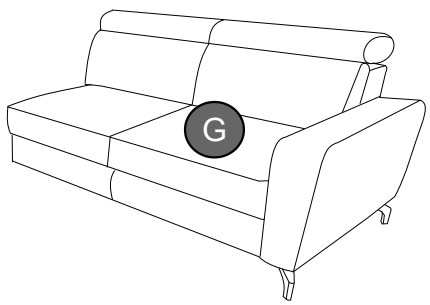

s H- 120 s1 ○ X3	q M6*25 X12	i L- 4 X1	f H- 120 X1	g H- 120 X2	[mm]
--	---------------------------	-------------------------	---------------------------	---------------------------	------

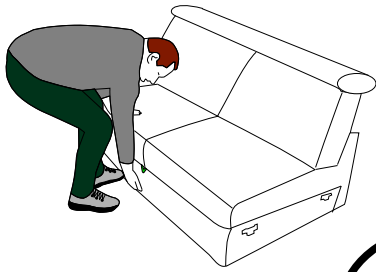

s H- 120 s1 ○ X2	q M6*25 X8	i L- 5 X1
--	--------------------------	-------------------------









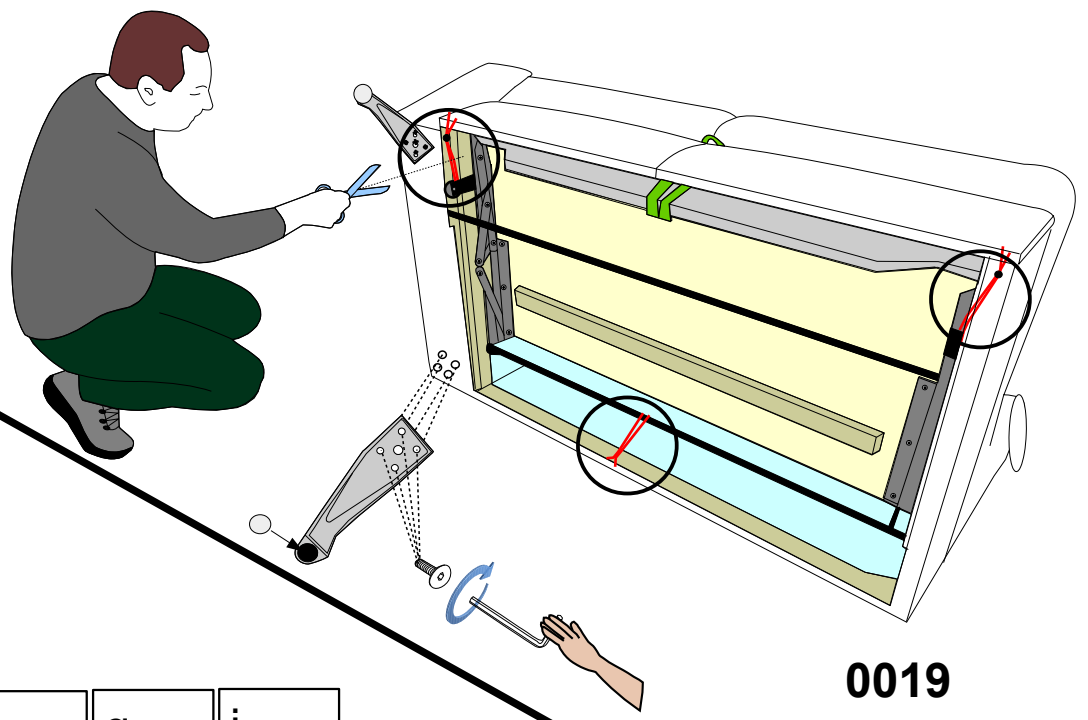

S H- 120 	q M6*25 	i L- 4 
S1 		
X2	X8	X1







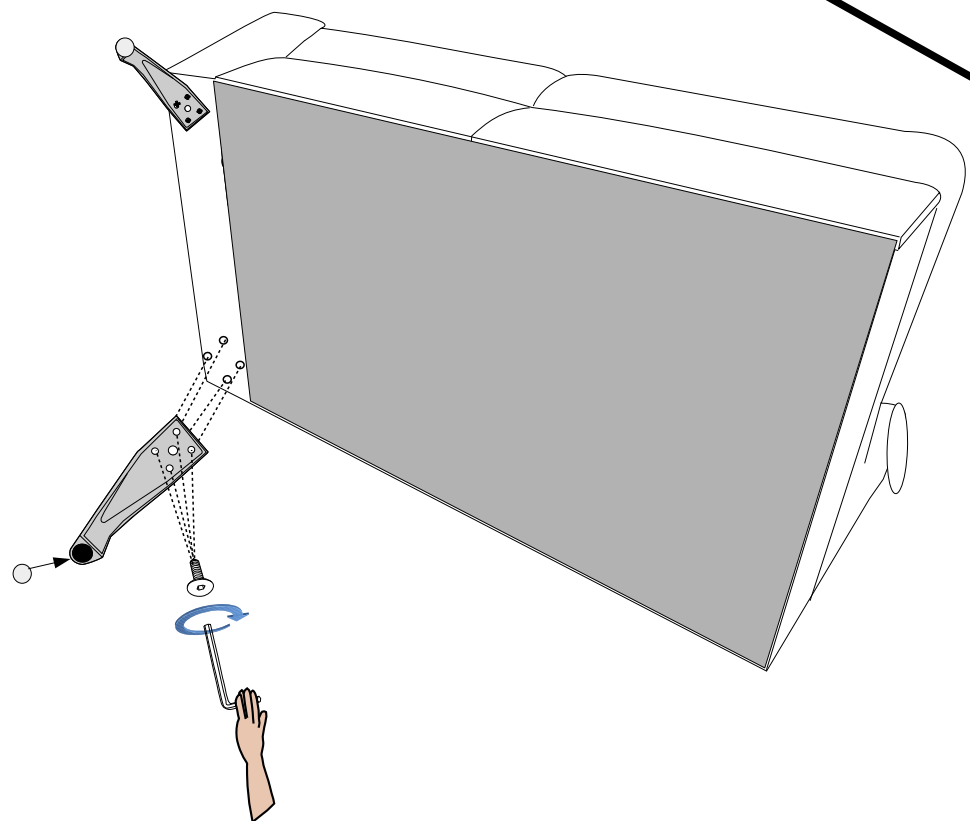

90°



S H- 120 	q M6*25 	i L- 4 
S1 		
X2	X8	X1



s H- 120 	q M6*25 	i L- 4 	f H- 120 	g H- 120 
s 1 				
X3	X12	X1	X1	X2

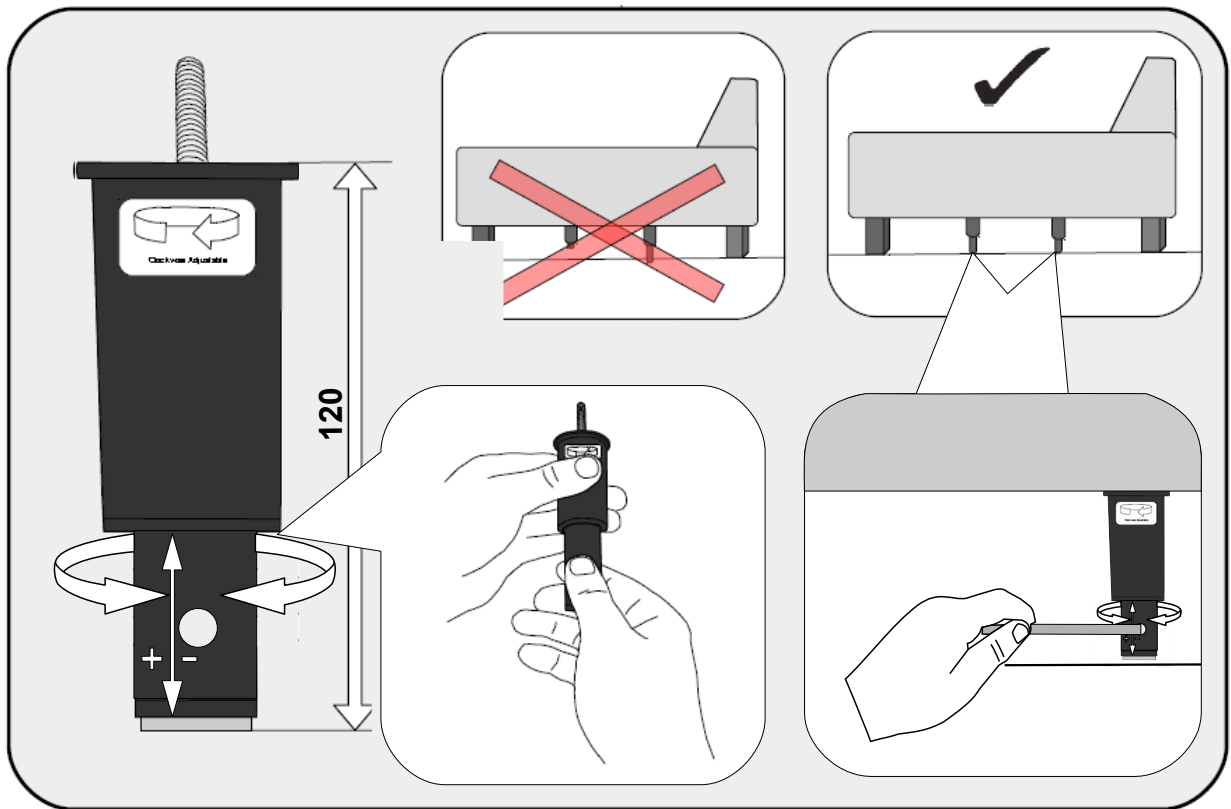
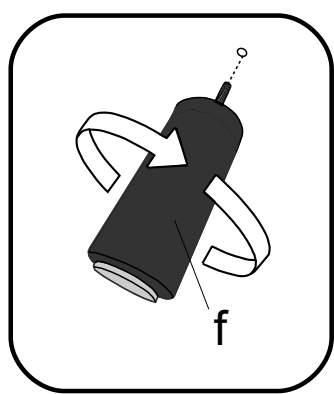
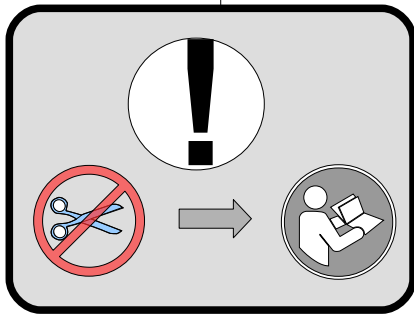
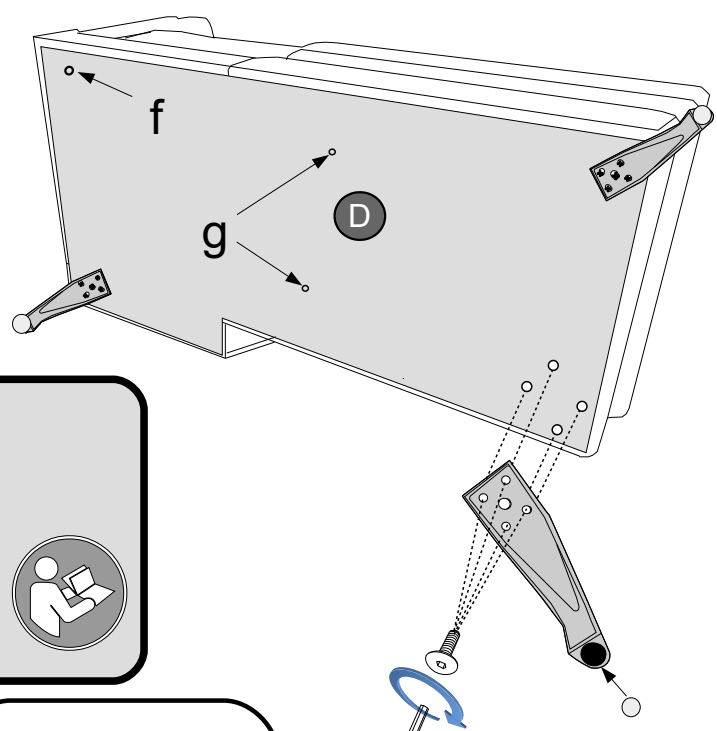
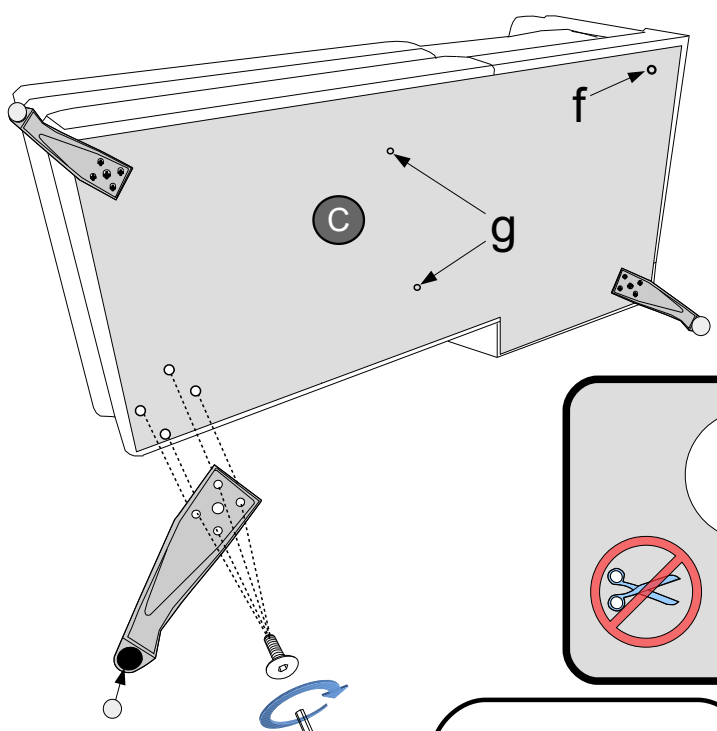

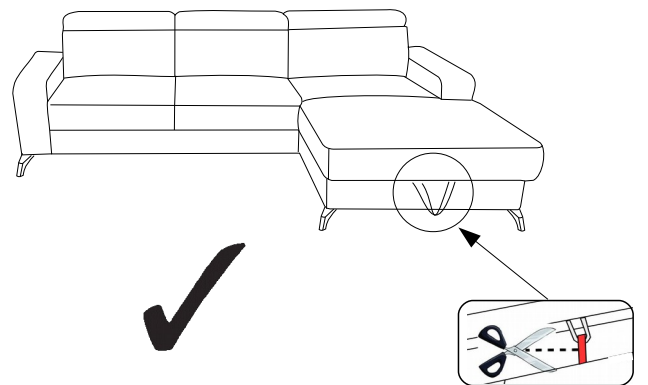
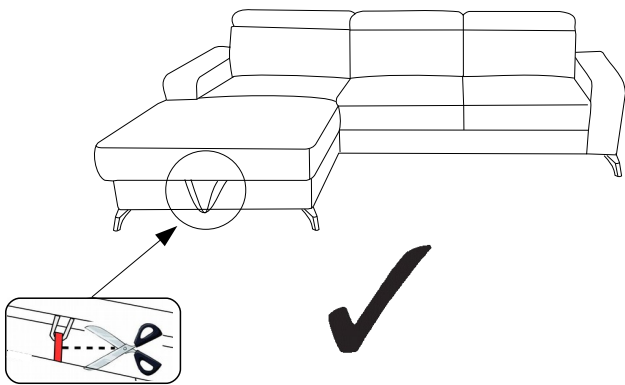
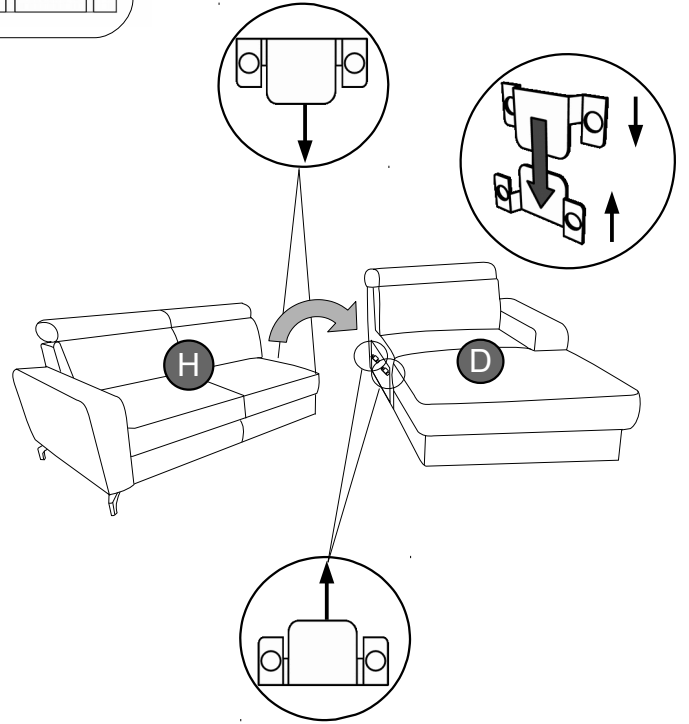
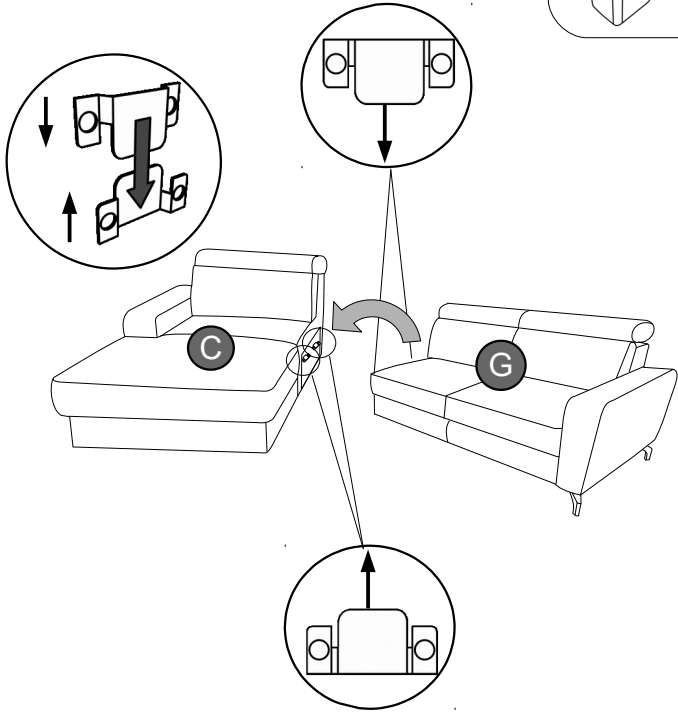
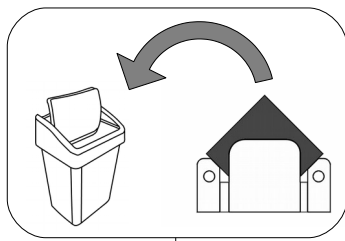

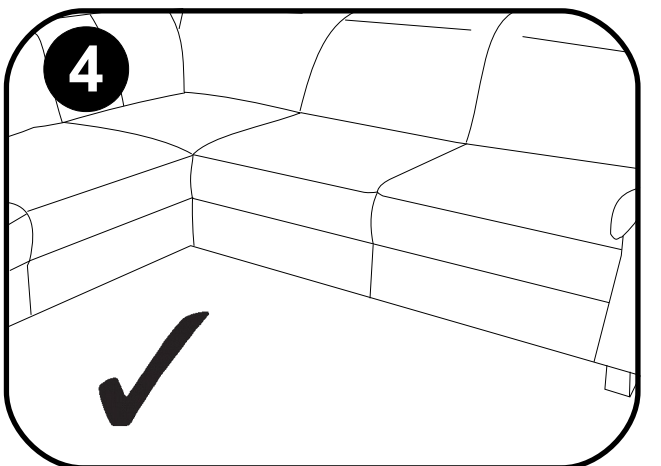
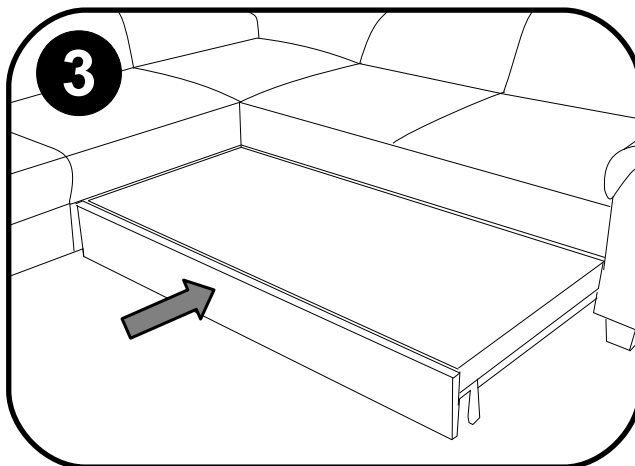
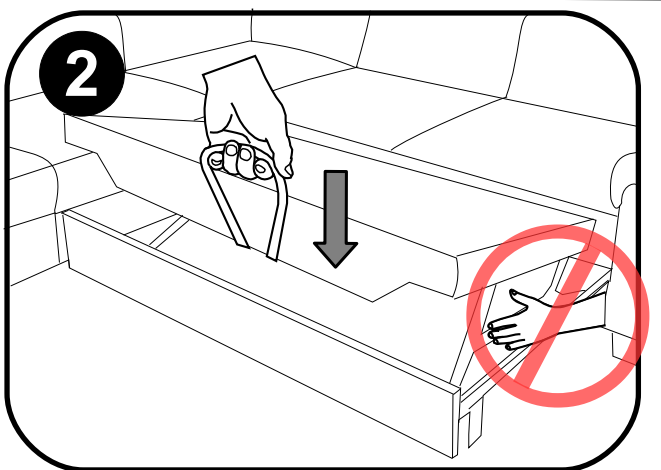
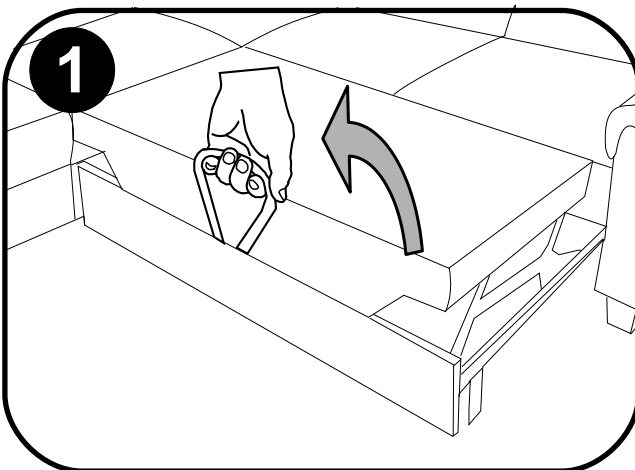
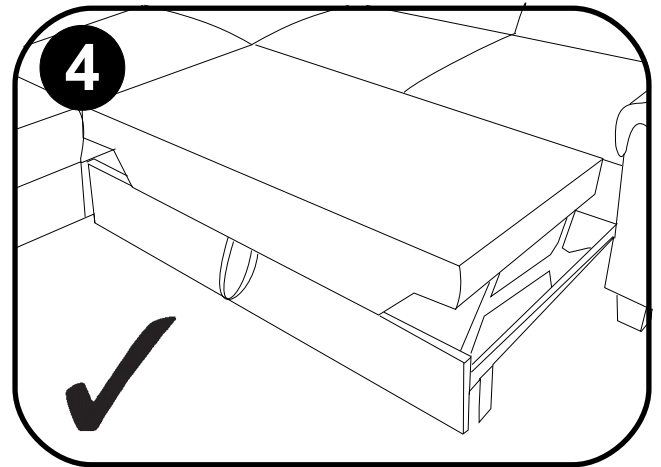
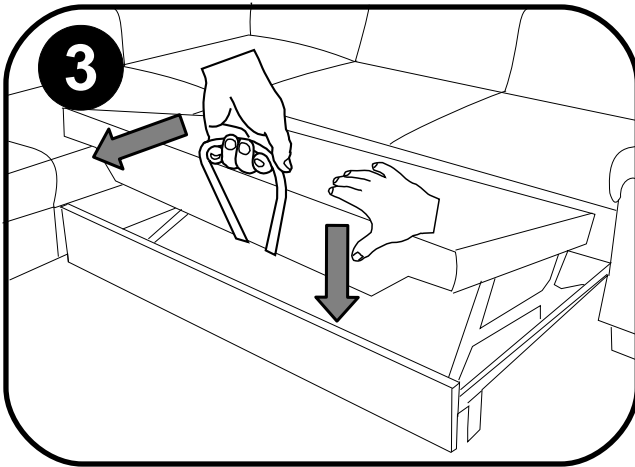
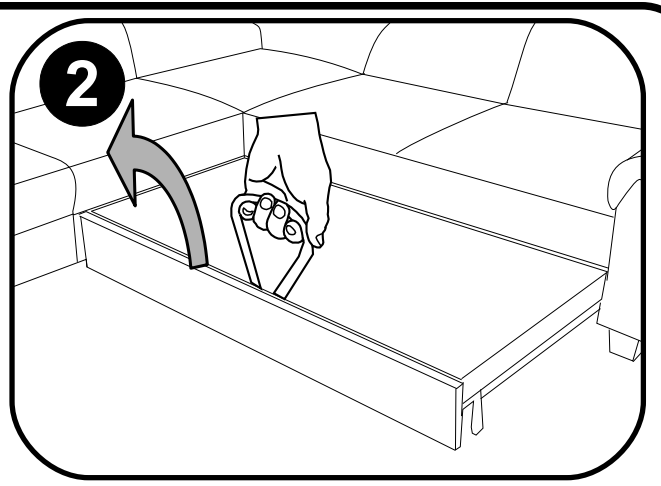
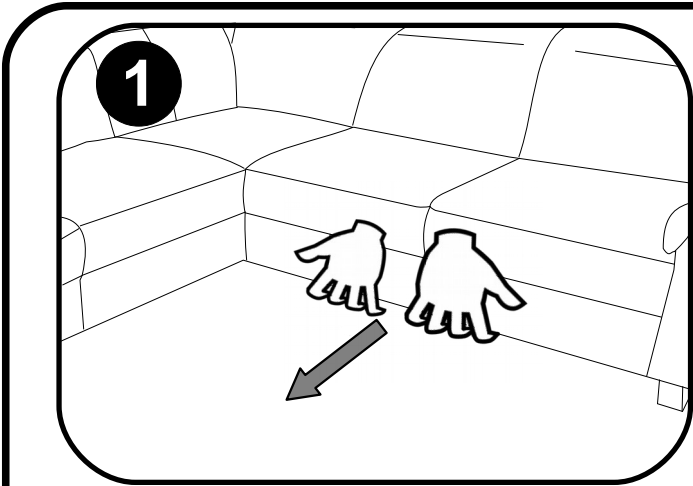
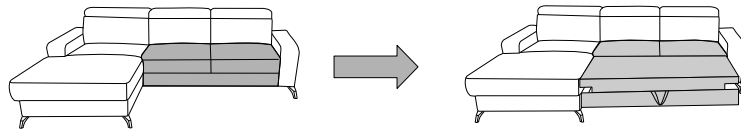

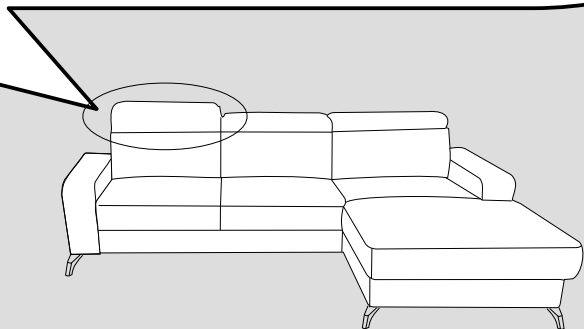
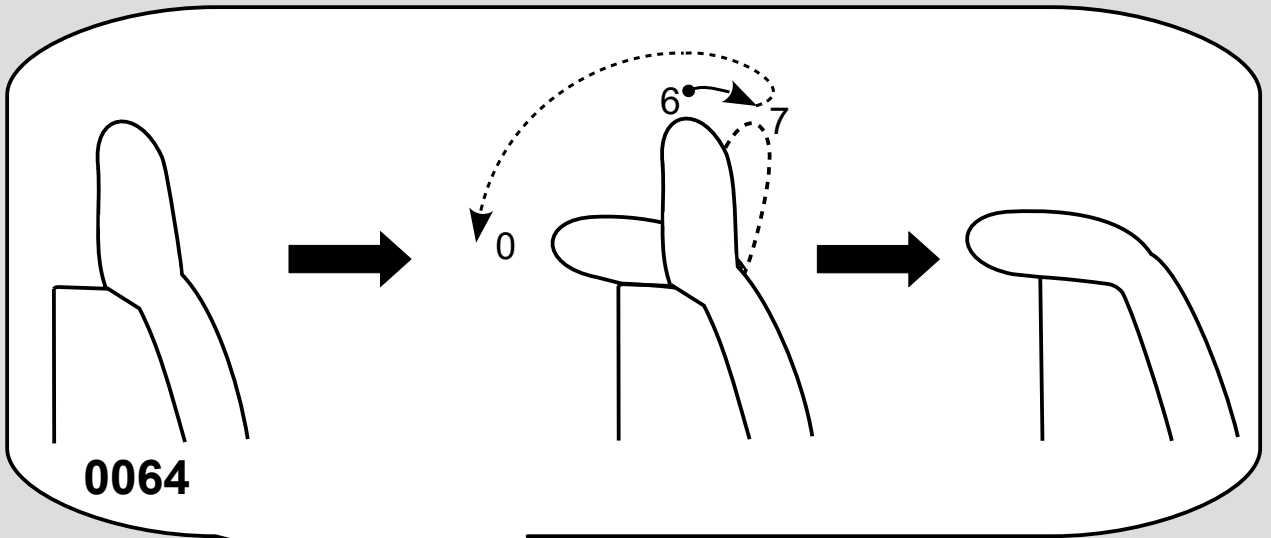
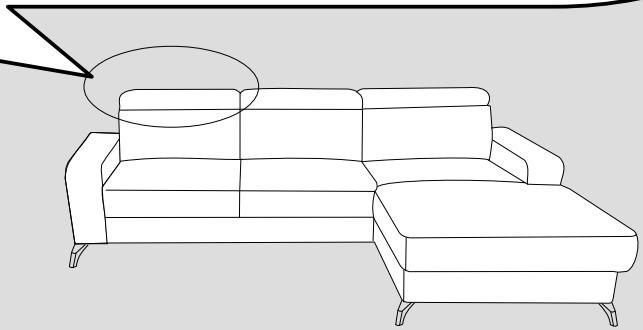
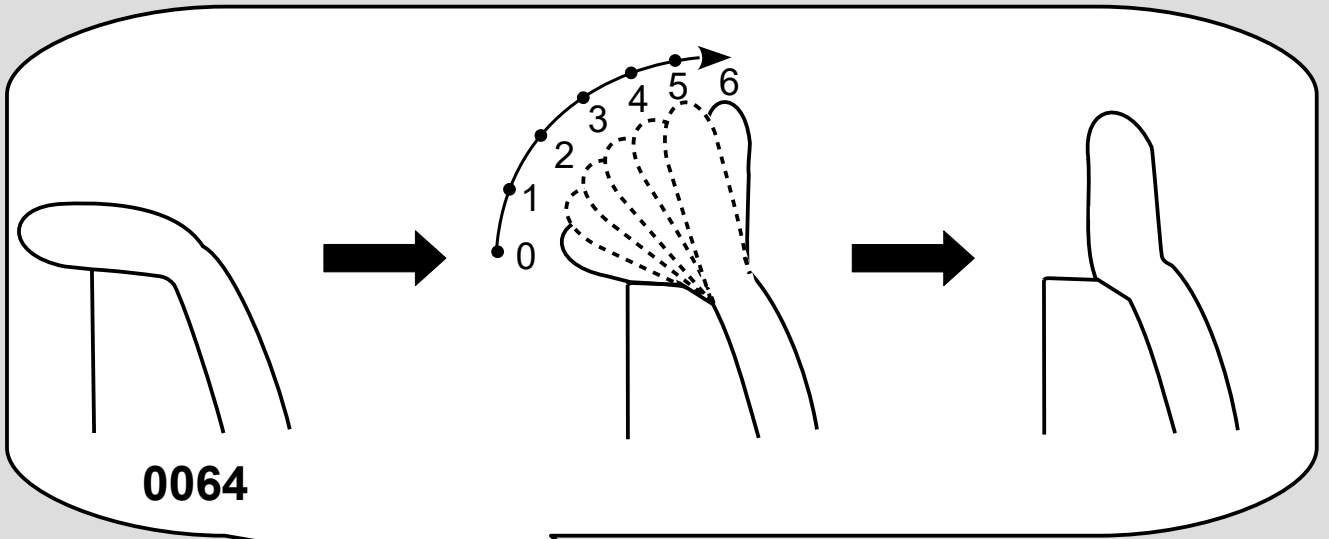

Service · Dienstverlening · Servis · Servis · Сервисная служба · Serviciu · Services · Servizio
 ·Servisný list · Szolgáltatás · Servisní list

Name · Naam · Nazwa · İsim · Название · Nume · Nome · Názov · Názov ·
 Název · Neve

SCARLETT V

Typ · Type · Tip · Тип · Tipo · Típus

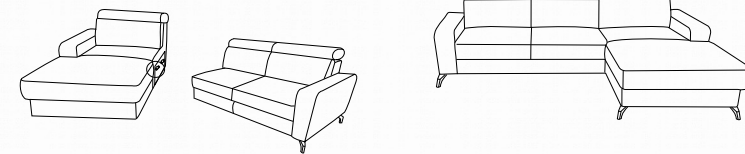
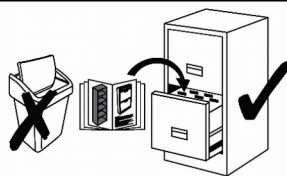

L

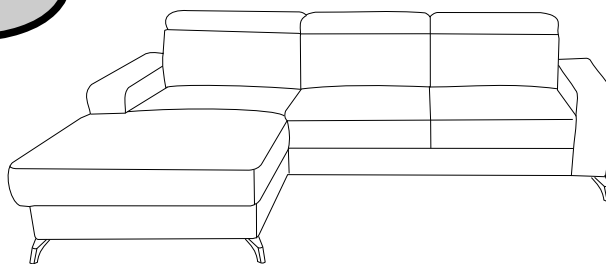

R

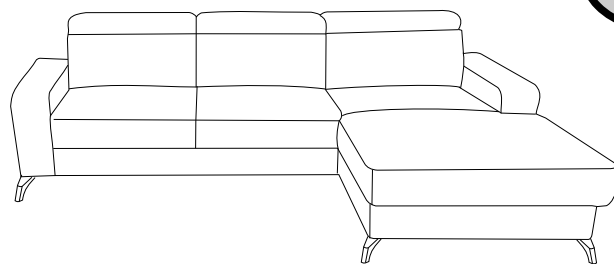

f H- 120 	g H- 120 	s H- 120 	q M6*25 	i L- 4 [mm]
s1 				

