

29643

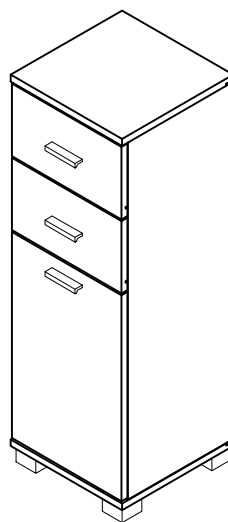

- | | | | |
|-----------|-----------------------------|-----------|-------------------------|
| D | Montageanleitung | GB | Assembly instructions |
| FR | Notice de montage | IT | Istruzioni di montaggio |
| NL | Handleiding voor de montage | PL | Instrukcja montażu |
| CZ | Montážní návod | SK | Návod na montáž |
| HU | Szerelési útmutató | RO | Instructiuni de montaj |
| TR | Montaj talimatı | RU | инструкция по монтажу |

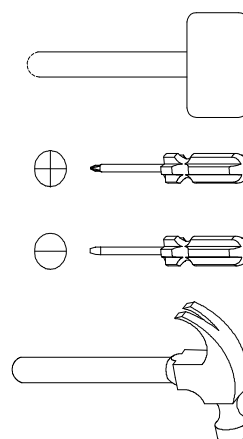

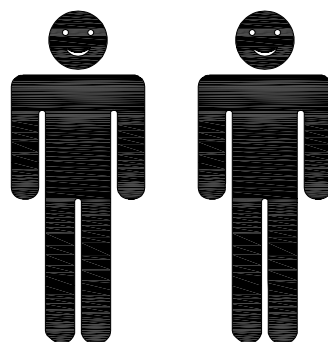







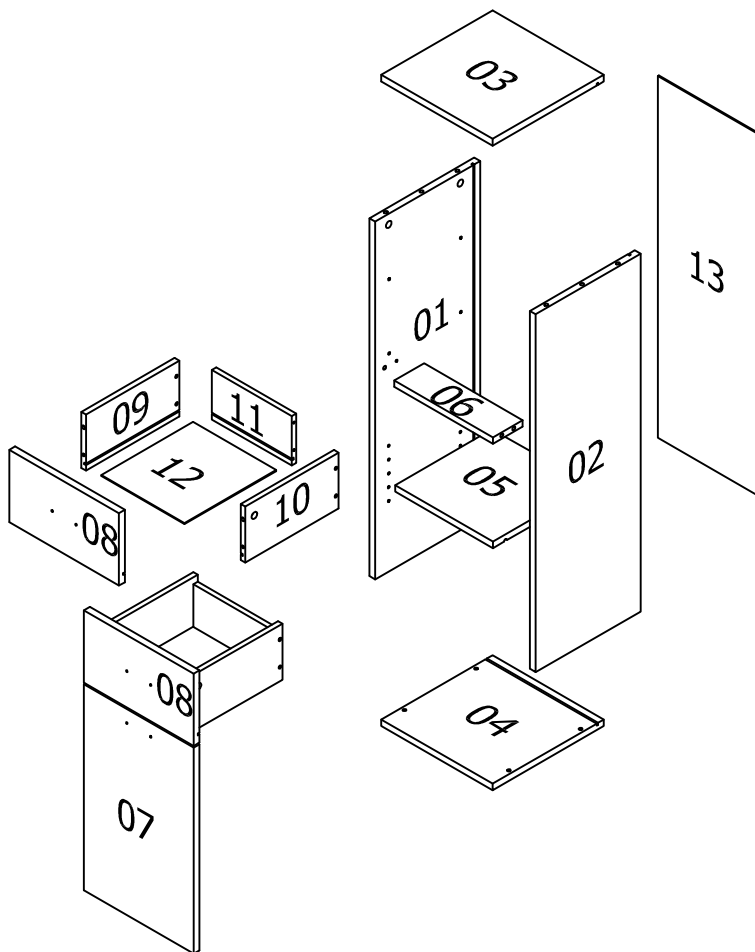
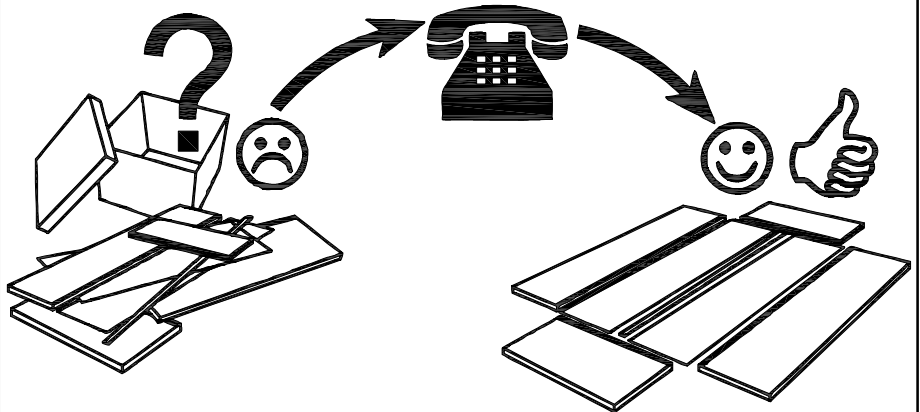
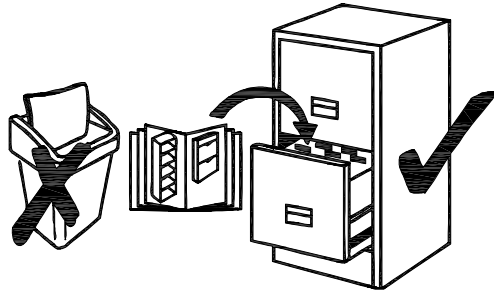



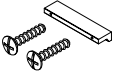

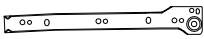

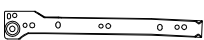

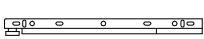

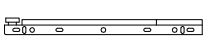

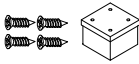



**Service • Assistenza • Dienstverlening • Serwis
Servis • Szerviz • Сервисная служба**

Name • Nom • Nome • Naam •
Nazwa • Jméno • Názov • Név •
Denimire • isim • Название

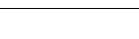
Nr. • No. • N° • Номер • Č • Sz

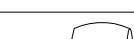
Typ • Type • Tip • Tipus • Tipo •
Тип

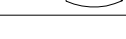

A		M3.5 X 12MM	8	N		M3.6 X 22MM	3 SETS
B		M3.5 X 15MM	13	P1		CR 250MM	2
C		M4.5 X 32MM	1	P2		CL 250MM	2
D		M6 X 9MM	8	Q1		DR 250MM	2
E		M6 X 13MM	4	Q2		DR 250MM	2
F		M6 X 40MM	12	R		M3.5 X 15MM	4 SETS
G		Ø6 X 20MM	4	S			4
H		Ø8 X 25MM	4	T		M4	1
J		24 X 8.5	10	U			8
K		15 X 12	6	V		1.2 X 12 X 145 MM	1
L		12/13	4	W			1
M1		5/8	2	Y		6X30	1
M2			2				

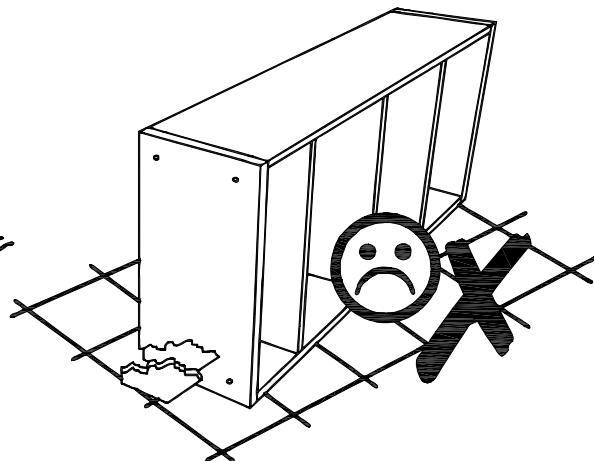
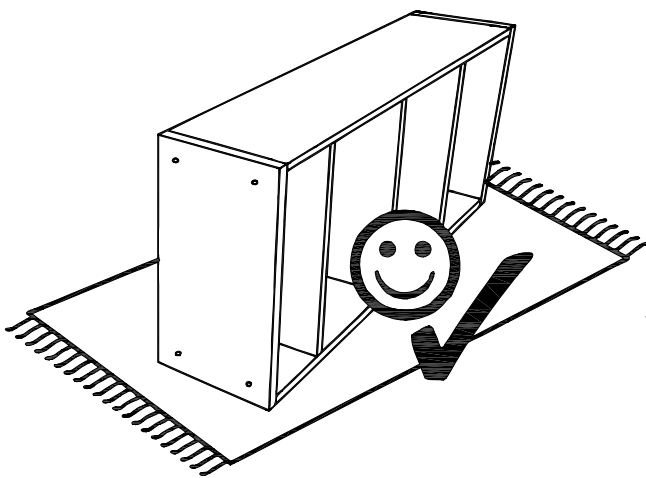

1

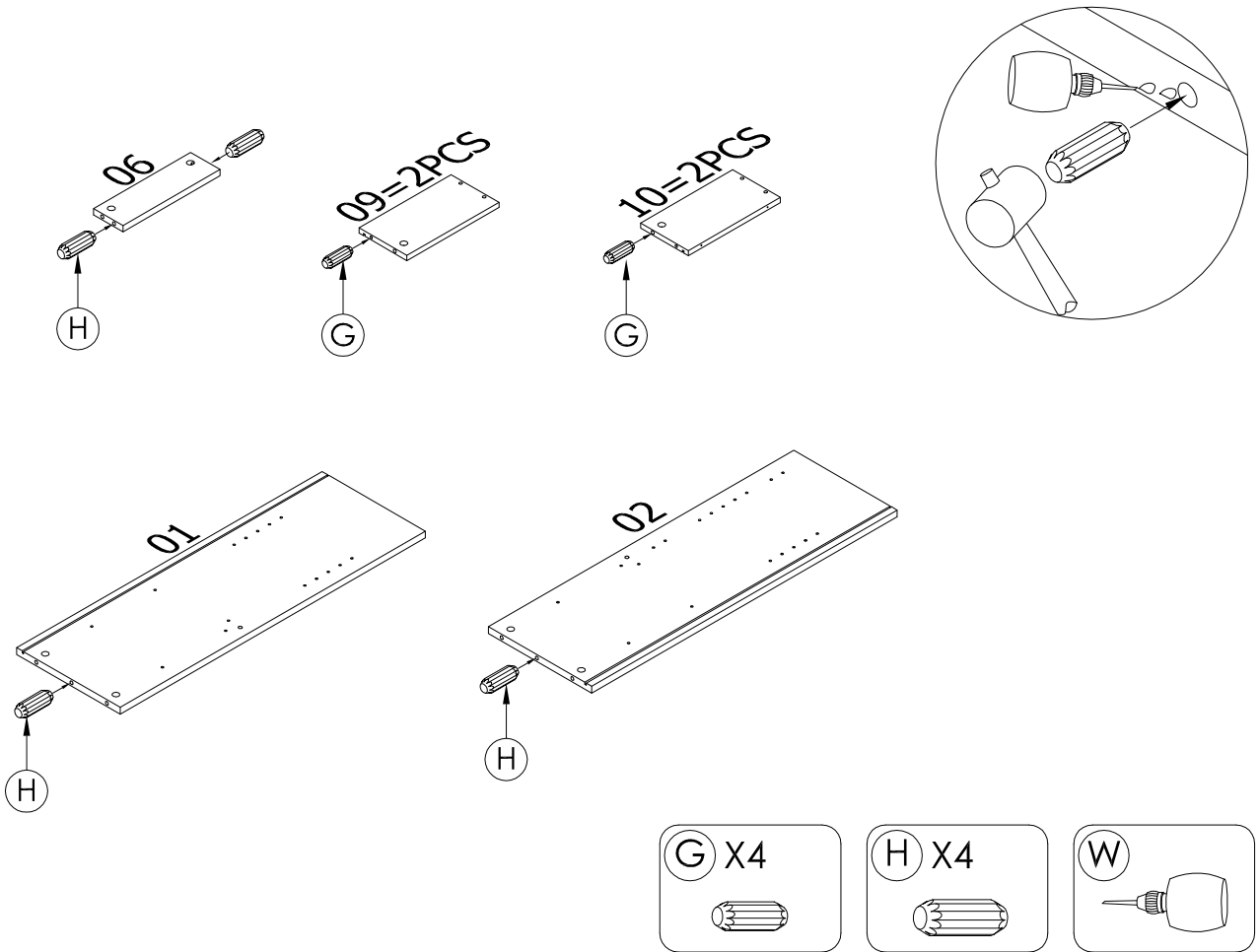

2

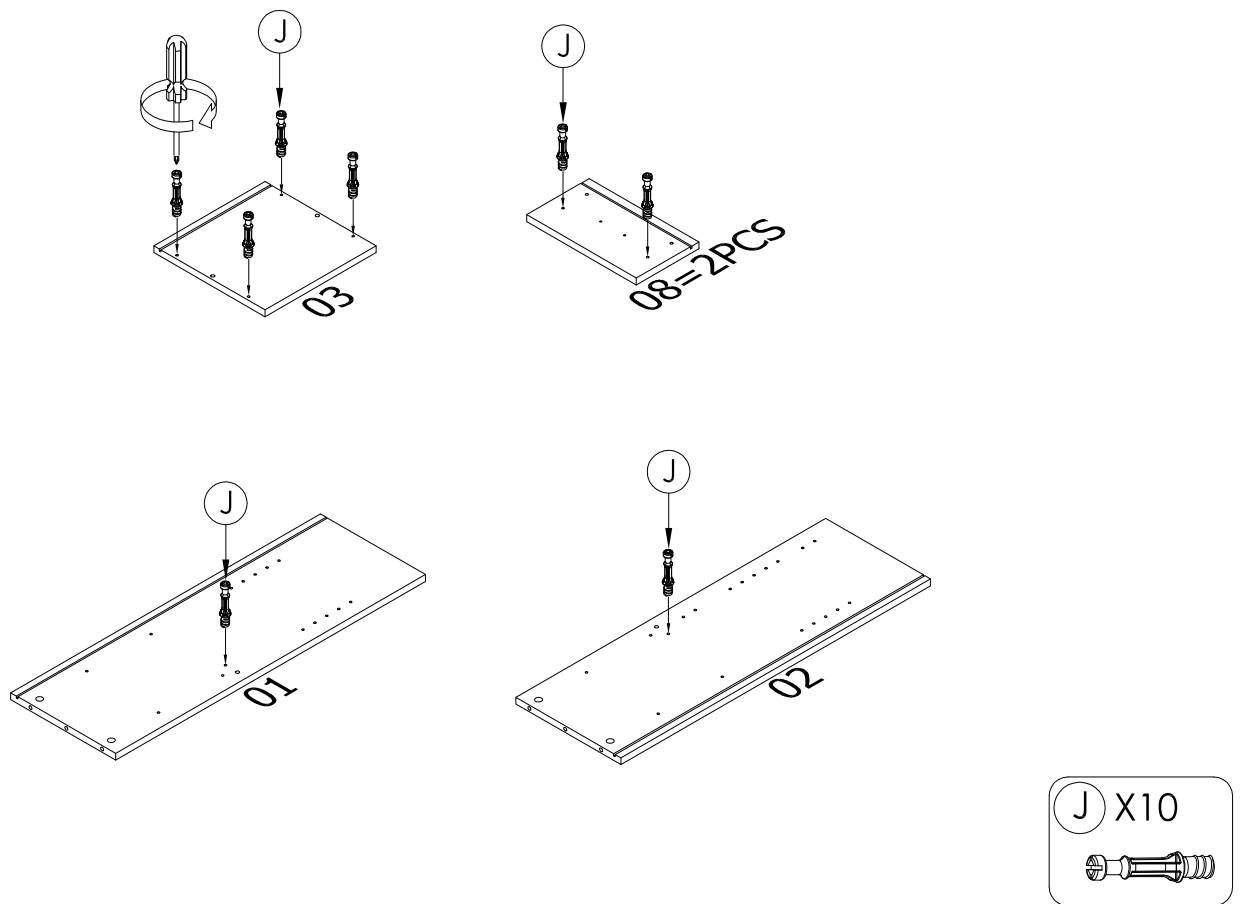

3

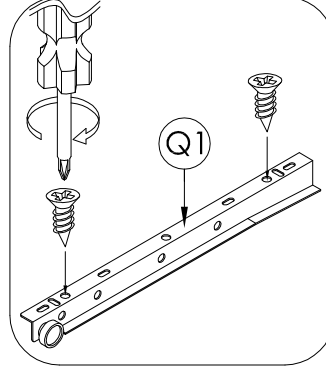
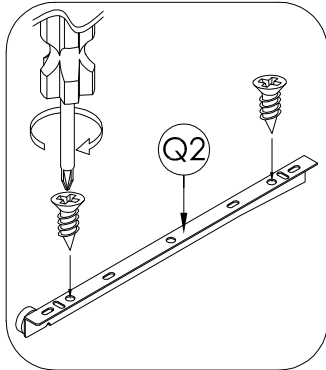
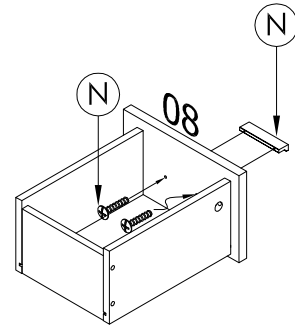
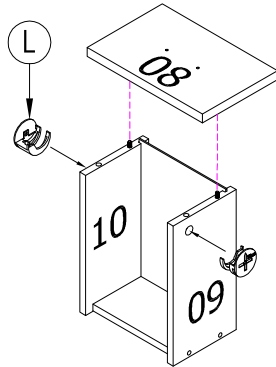
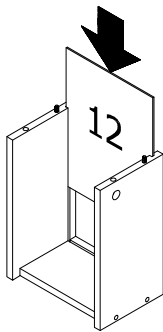
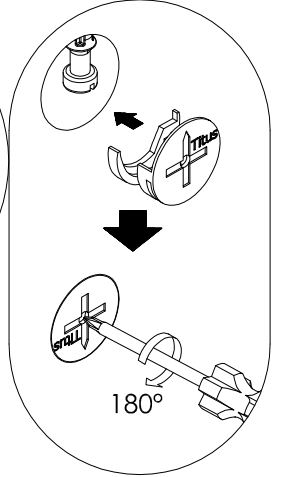
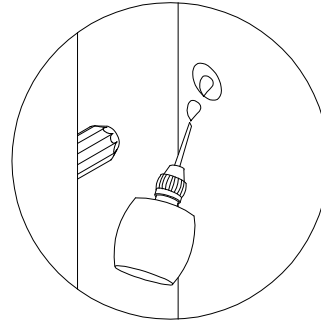
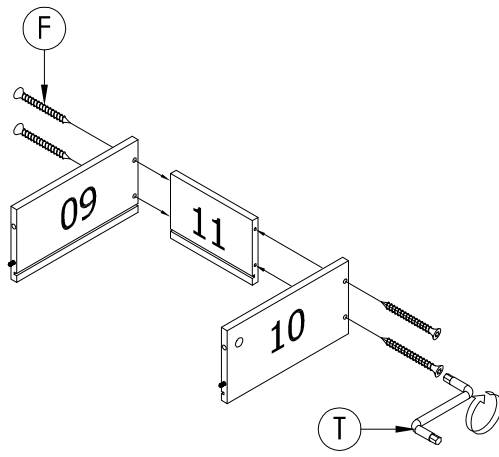

X2

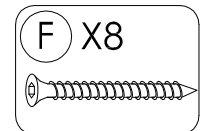
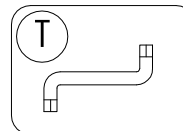
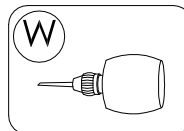
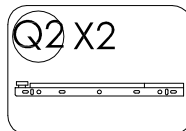
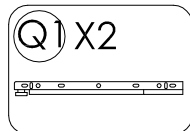
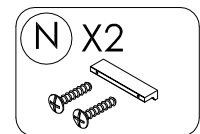
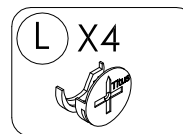
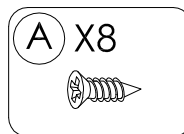
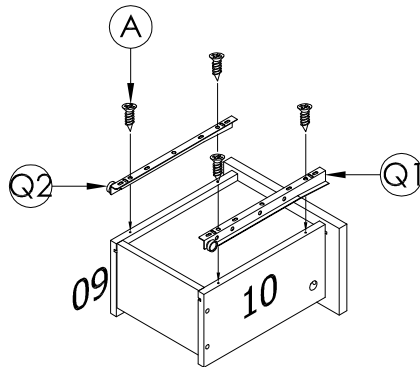

4

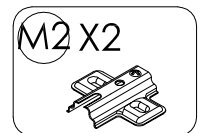
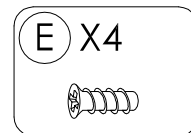
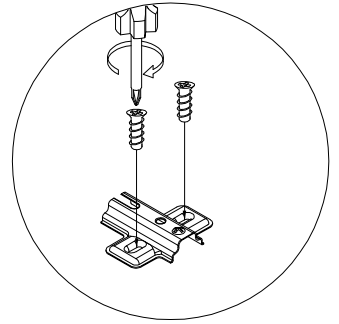
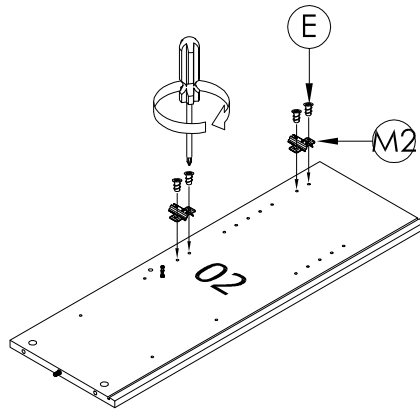

5

