



EKIPA

0094NOTIC6123



BUFFET DE CUISINE

184,6cm
120,1cm
40,3cm



FR Remerciements :
Nous vous remercions d'avoir
choisi un meuble créé et fabriqué
par Ekipa et espérons qu'il vous
donnera entière satisfaction.

EN Thanks :
Thank you for choosing furniture
designed and manufactured by
Ekipa. We hope you are totally
satisfied your purchase.

ES Agradecimientos :
Les damos las gracias por haber
elegido un mueble diseñado y
fabricado por el Ekipa y esperamos
que sea de su total agrado.

DE Danksagung:
Wir danken Ihnen für den Kauf eines
Frankreich von der Ekipa
entworfenen und hergestellten Möbelstücks
und hoffen, dass Sie es zu Ihrer
vollkommenen Zufriedenheit finden werden.



Temps de montage : 2h00



contact@parisot.com



Conseils de préparation au montage : 15 min

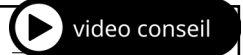

<https://qrco.de/bcJeNz>

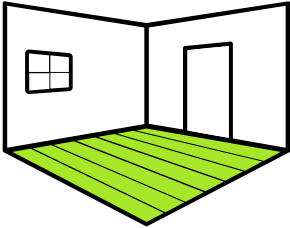

Faire un peu de place

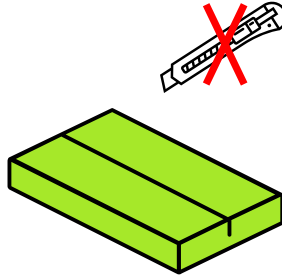

Pas d'outils tranchants

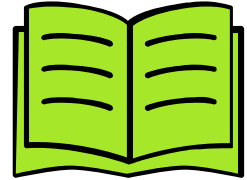

Bien suivre les instructions de la notice de montage

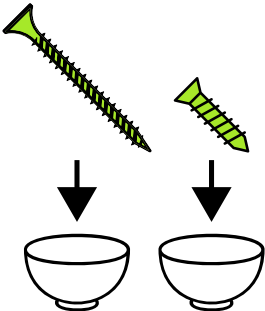

Trier vos quincailleries

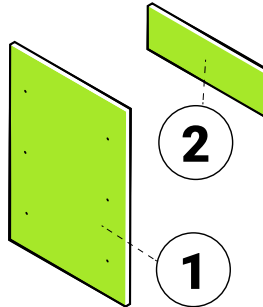

Repérer vos pièces

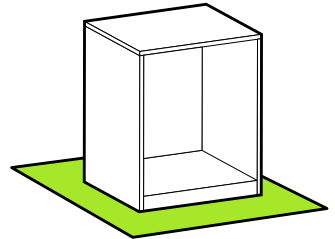

Protéger votre sol

Matériel nécessaire

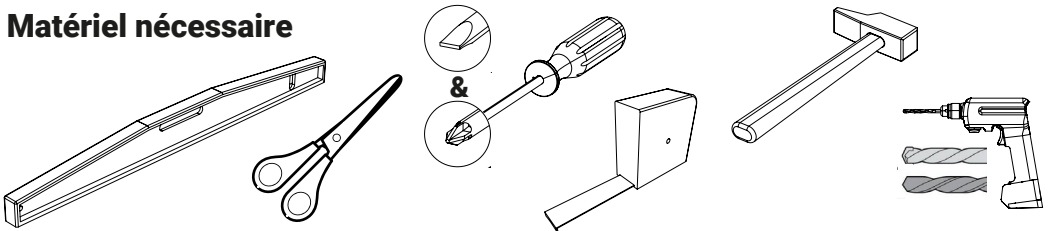

Conseils d'entretien

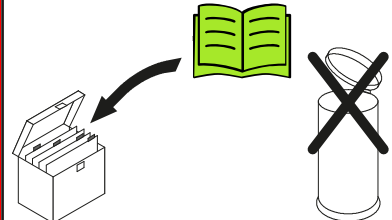

Repérer vos pièces à l'aide de «post-it» non fournis

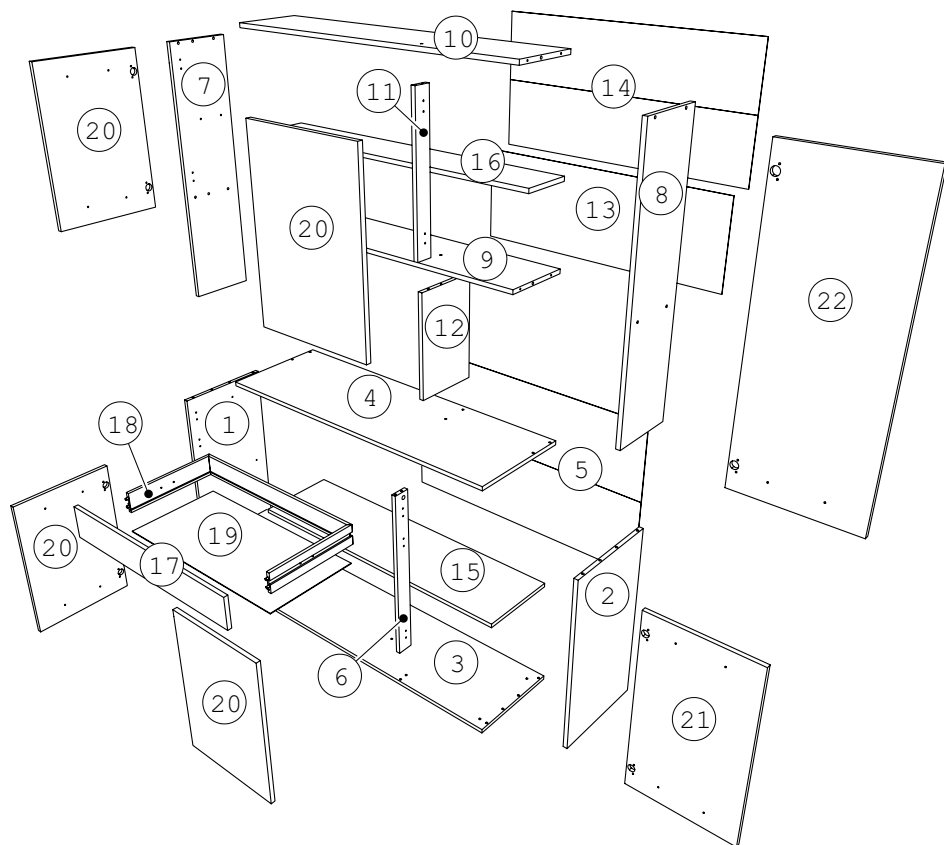









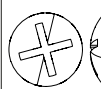
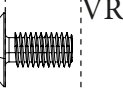
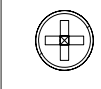
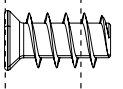
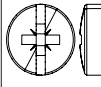
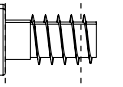
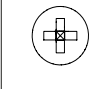
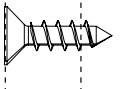
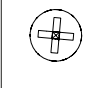
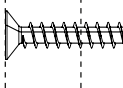
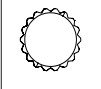
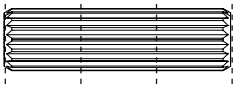
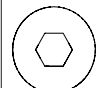
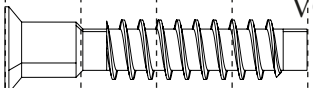
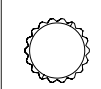
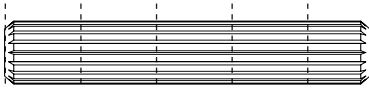

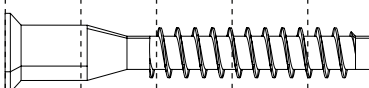

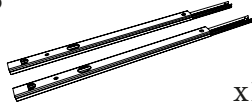

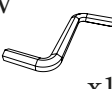



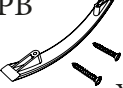
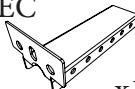



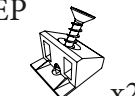
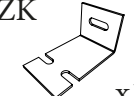

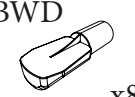
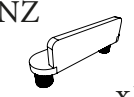

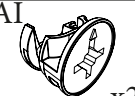

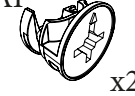

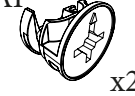

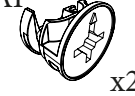

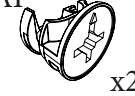

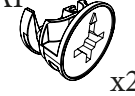

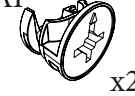
Rep	Qté	cm			Rep	Qté	cm		
01	1	69,6	38	1,6	12	1	39,2	24,5	1,6
02	1	69,6	38	1,6	13	1	119,3	40,8	0,25
03	1	120,1	38,05	1,6	14	1	119,3	57,7	0,25
04	1	120,1	40	1,6	15	1	116,7	31,5	1,6
05	1	119,3	72	0,25	16	1	116,7	18,1	1,6
06	1	69,6	6,4	1,6	17	1	79,7	12,5	1,6
07	1	97,8	24,6	1,6	18	1	149,5	8	1,25
08	1	97,8	24,6	1,6	19	1	74,5	36,7	0,25
09	1	116,8	24,55	1,6	20	4	57,4	39,7	1,6
10	1	116,8	24,55	1,6	21	1	70,2	39,7	1,6
11	1	55,35	6,4	1,6	22	1	97,2	39,7	1,6

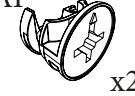
Trier vos quincailleries

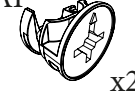

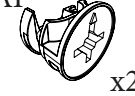
0 1cm 2 3 4 5

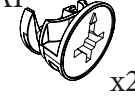
		VR	x2
		BWF	x6
		CDS	x48
		VG	x5
		WJ	x10
		ADM	x28
		VO1	x5
		AB	x2
		HW	x16

			CP	x1
			FA	x10
			HV	x1
			PAS	x7
			EC	x1
			Pied	x5
			CF	x1
			JB	x2
			AI	x2
			BSD	x2
			ZK	x1
			NZ	x1
			PB	x7
			PA	x40
			OO	x16
			CDA	x12
			CDD	x12

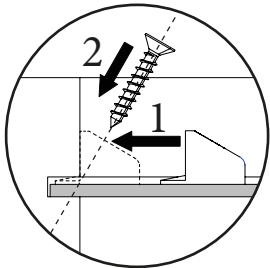
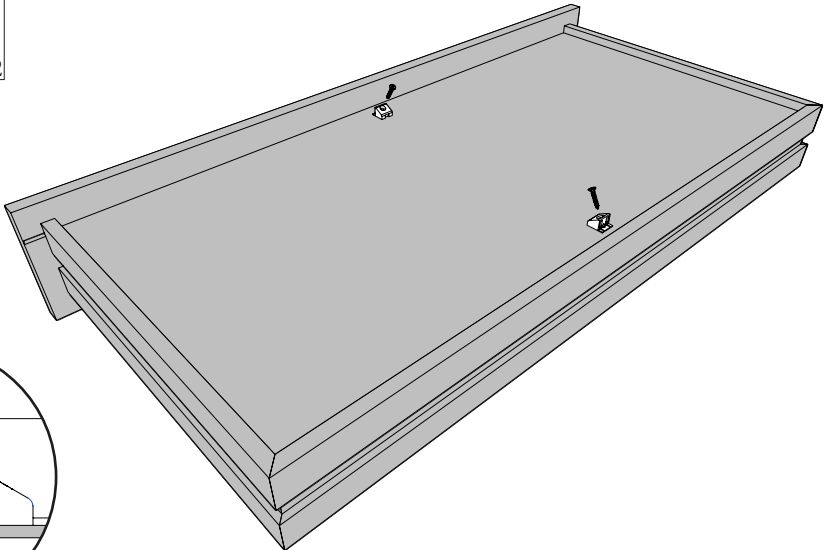
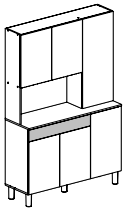
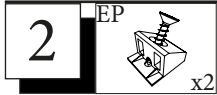
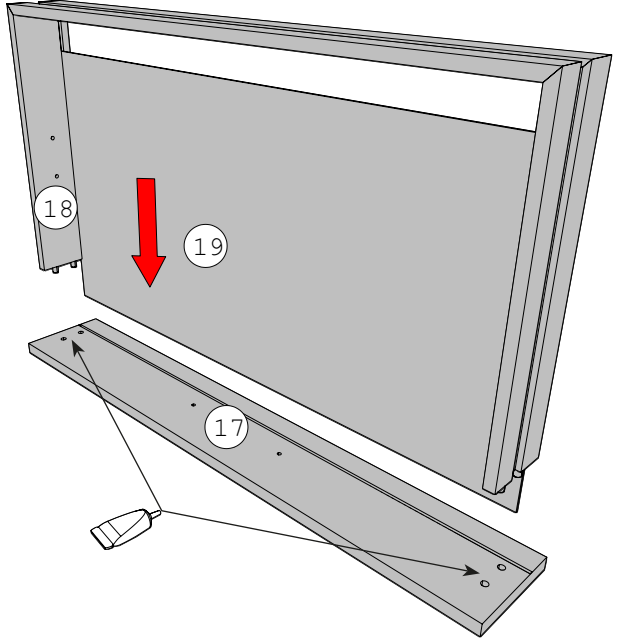
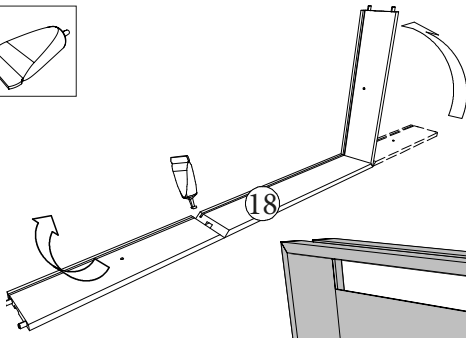
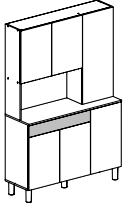
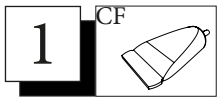

3



ADM

x10



BWF

x2



VGCF

x1



CP

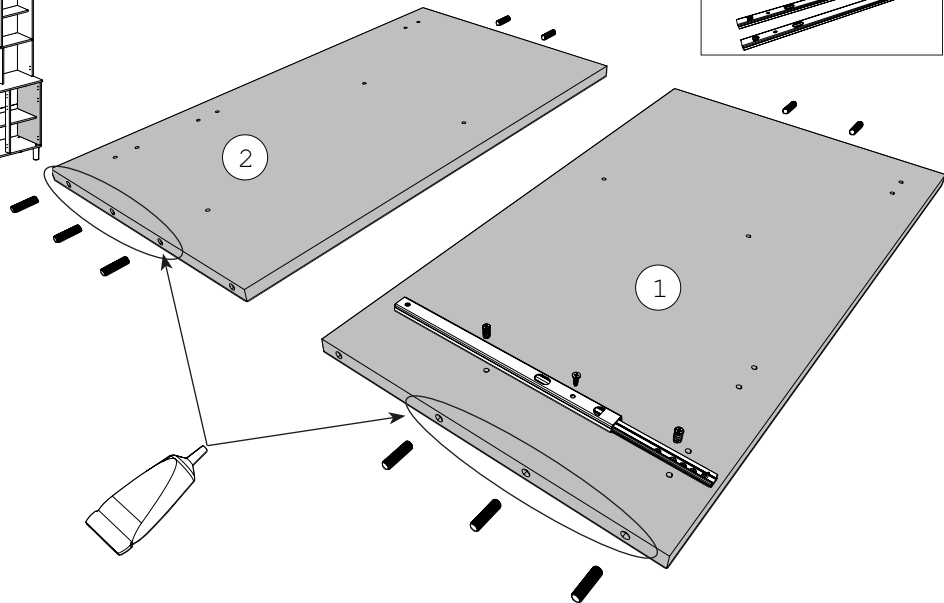
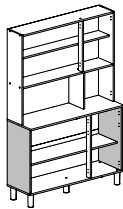

Extérieur du meuble



1

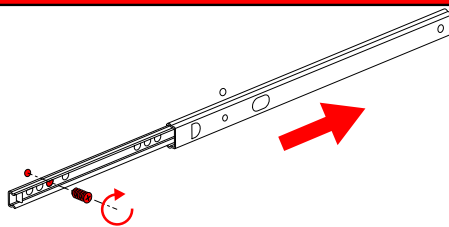

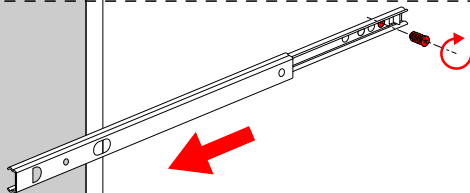

2



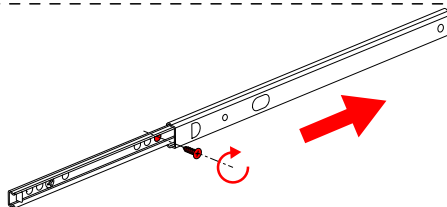

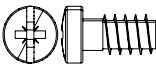
3

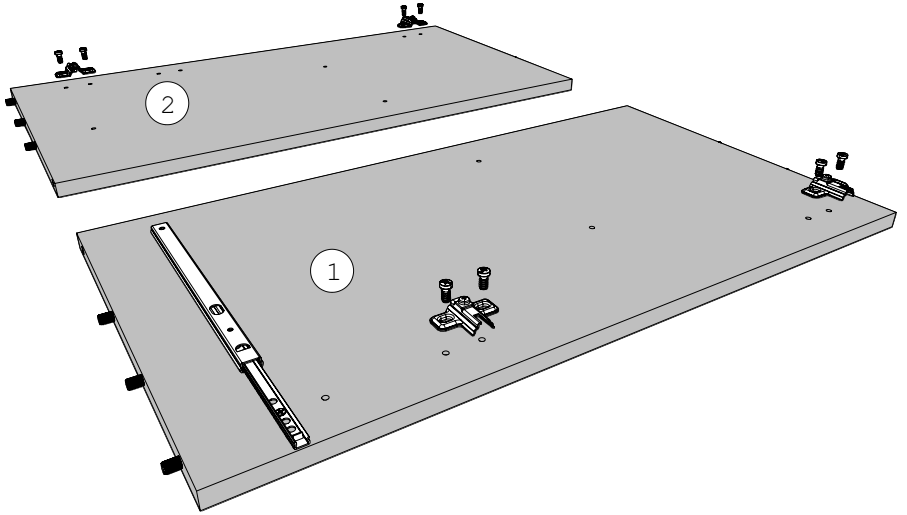
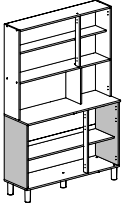

4	CDD		CDS
			
	x4		x8

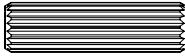

5	CDD		CDS		ADM
					
	x2		x4		x3

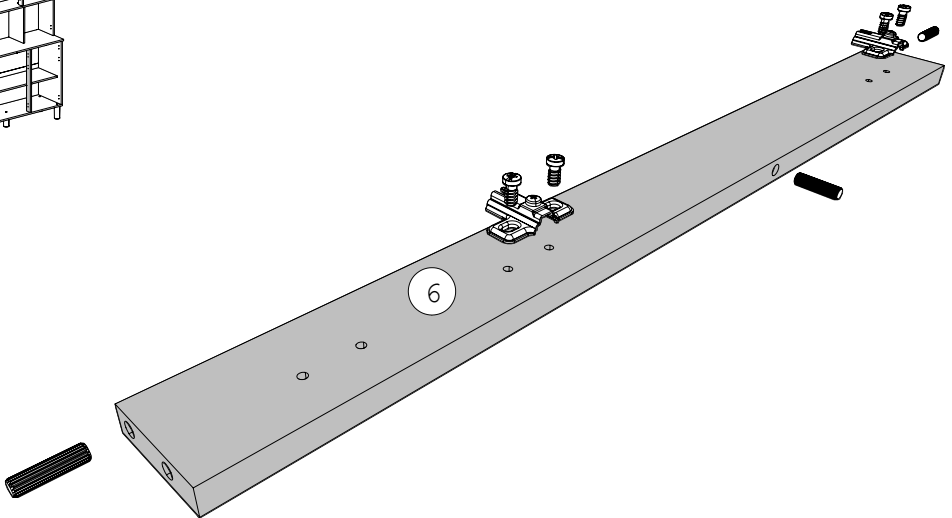
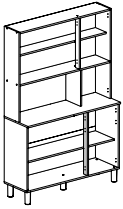

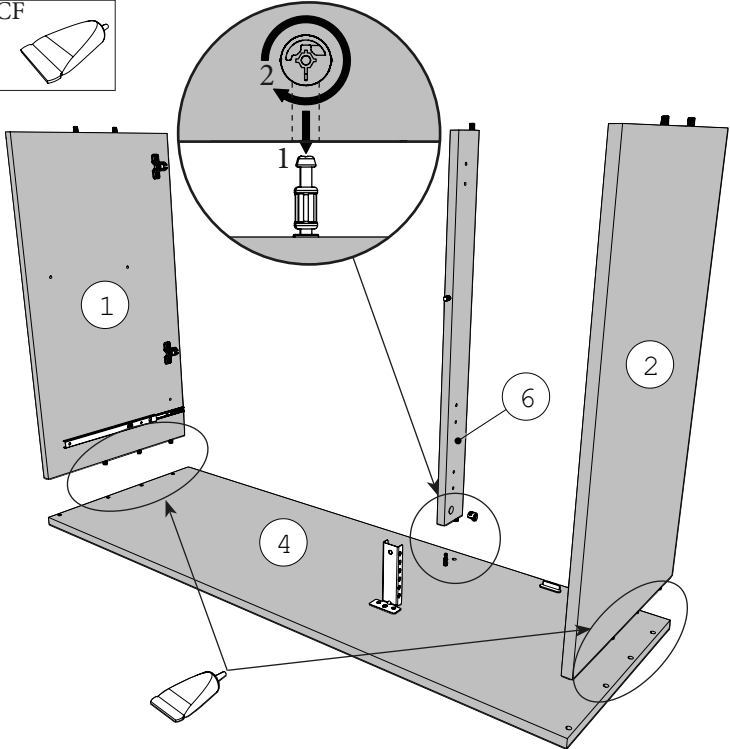
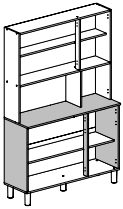
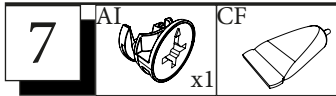
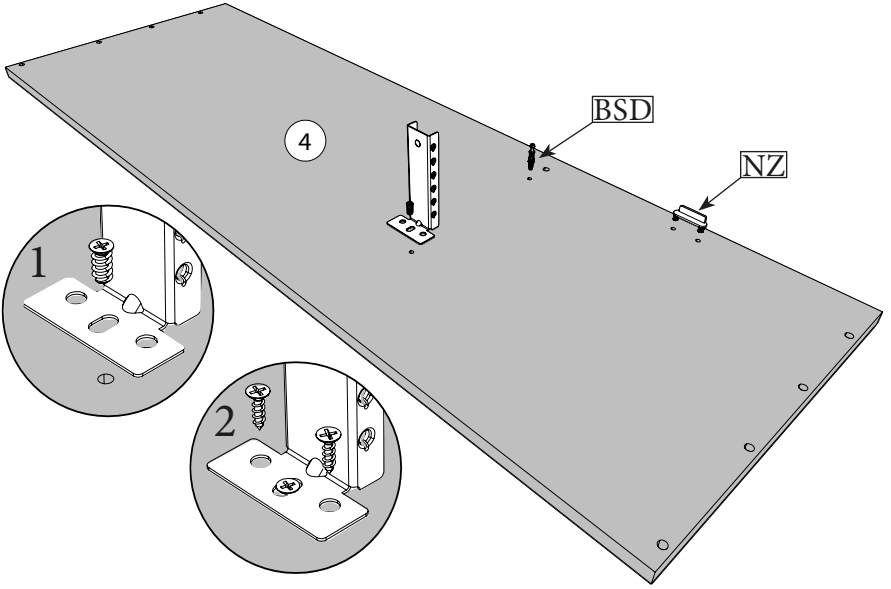
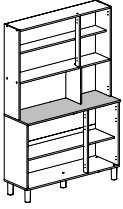
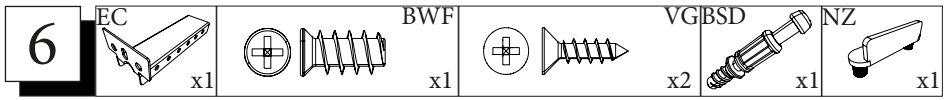

8

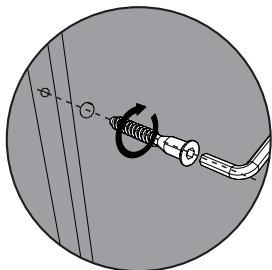
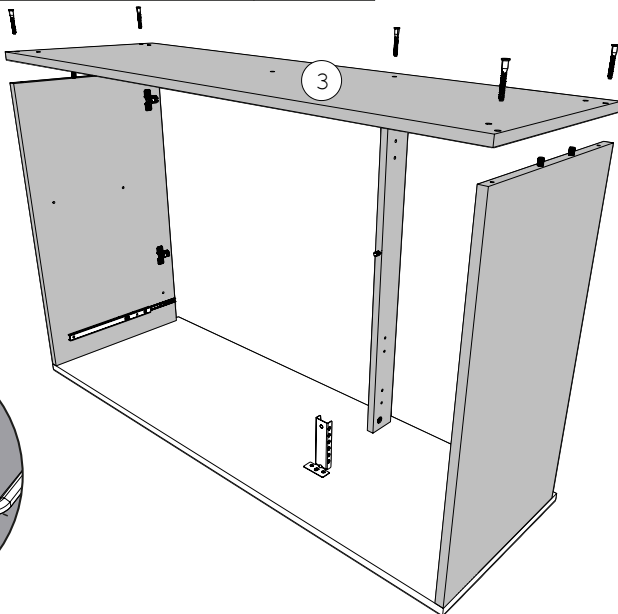
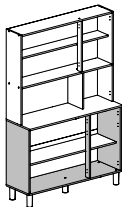
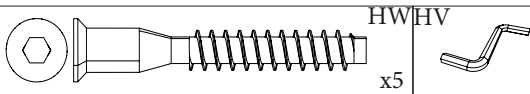

9

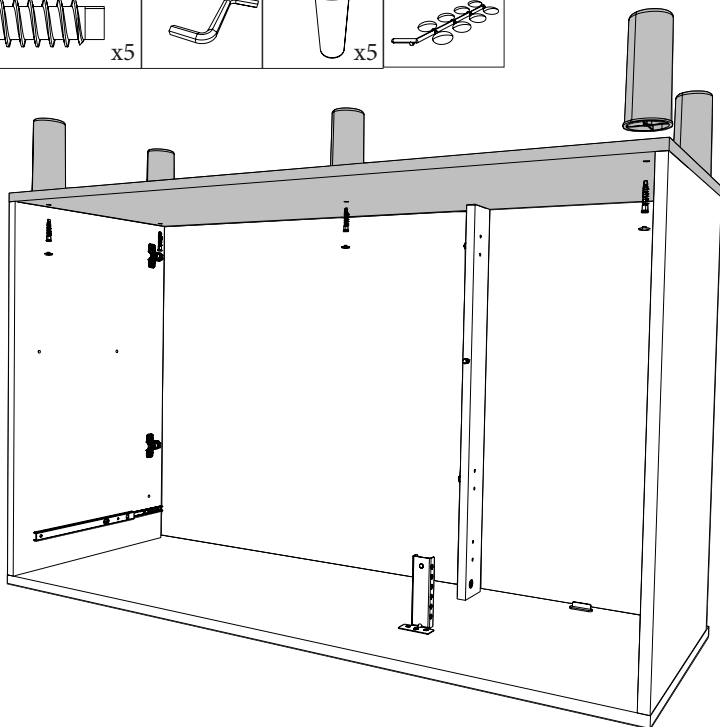
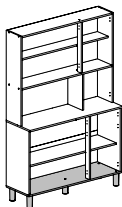
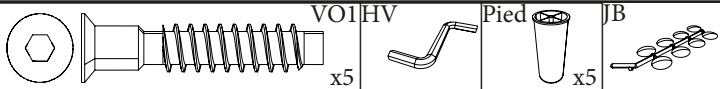

10

CP



BWF

x2

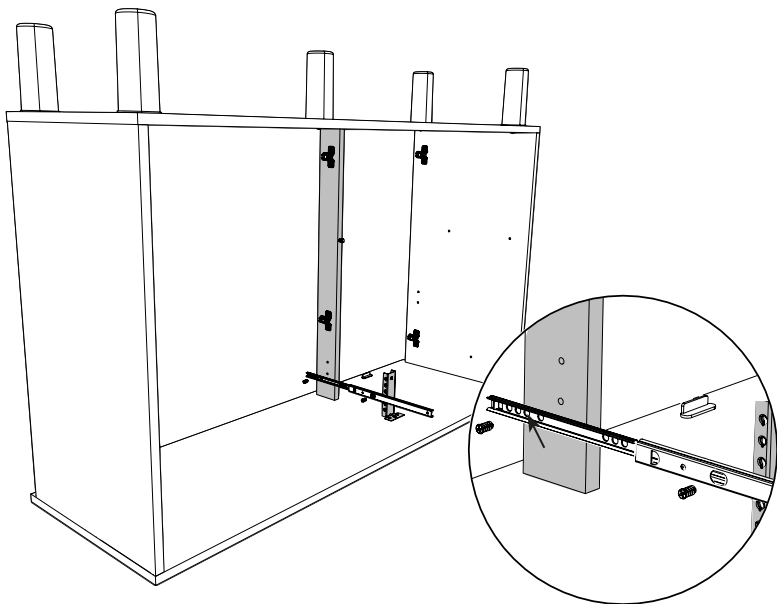
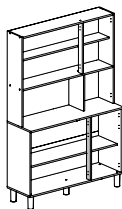

11

PA



x20

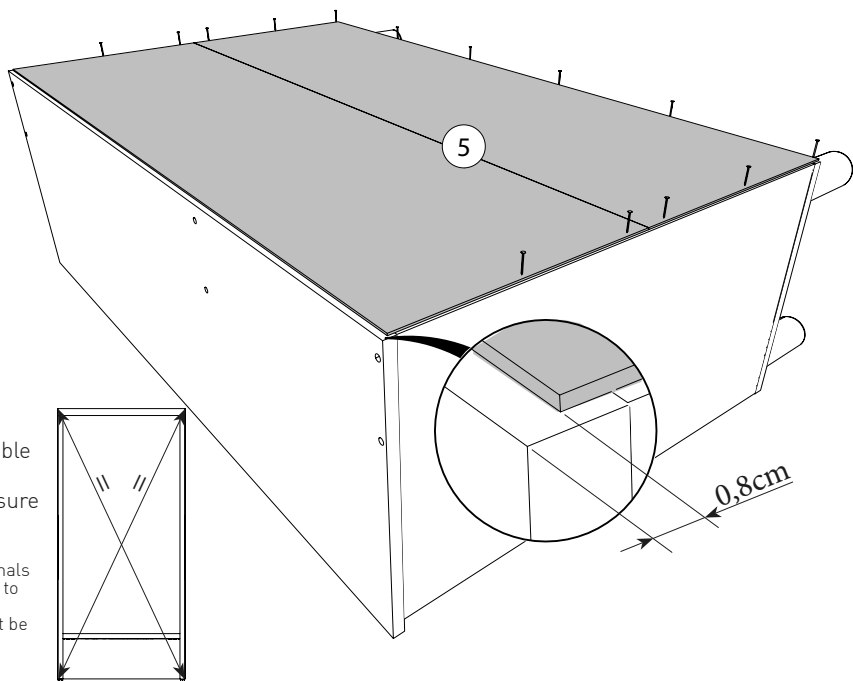
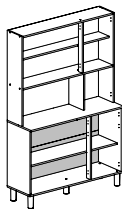

FR- Mesurer les diagonales du meuble pour vérifier l'équerrage. La mesure doit être identique.

EN- Measure the diagonals of the piece of furniture to check for straightening. The measurement must be identical.

12 CDD x4 CDS x8

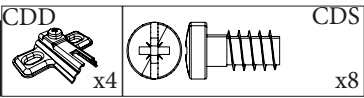

AB x2
ADM x2

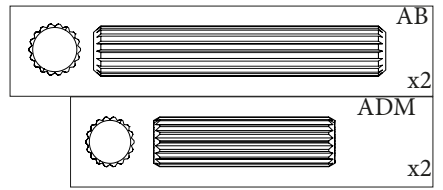
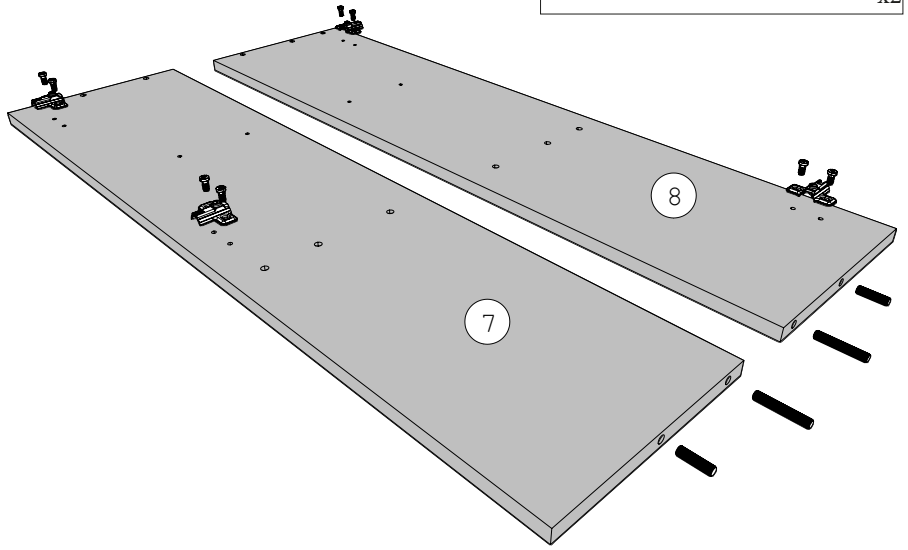
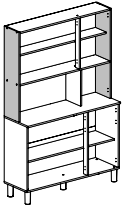
13 ADM x11

14

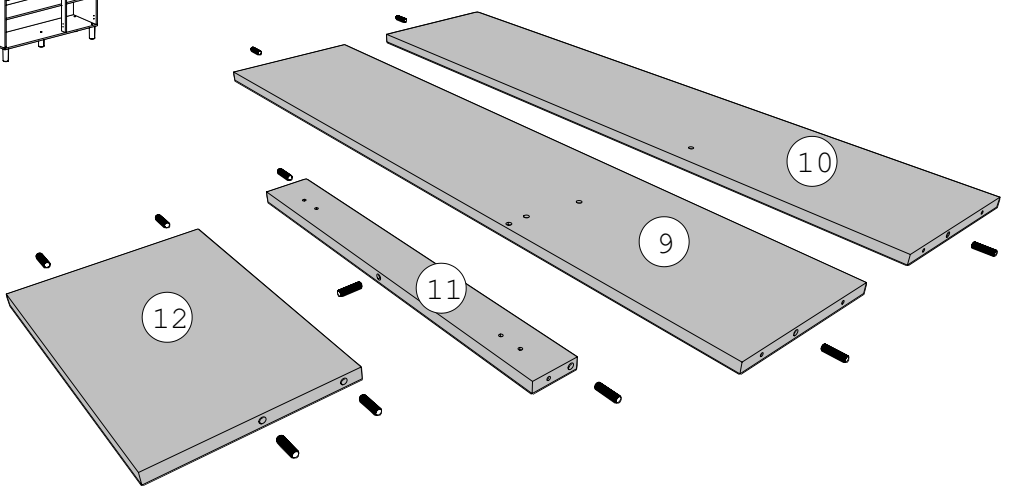
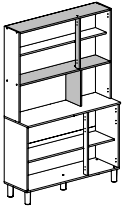

15

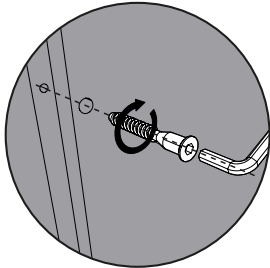
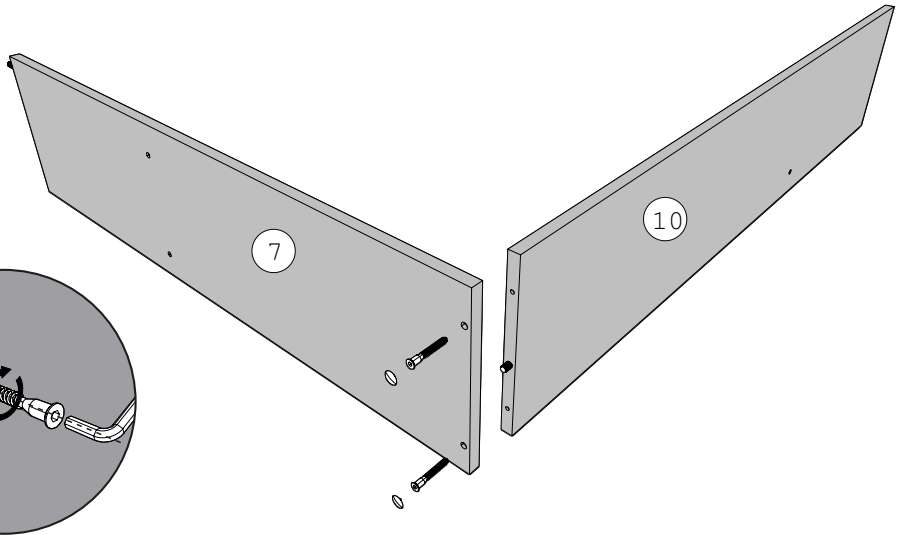
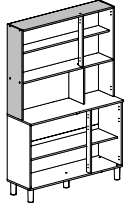
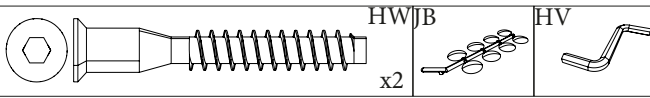

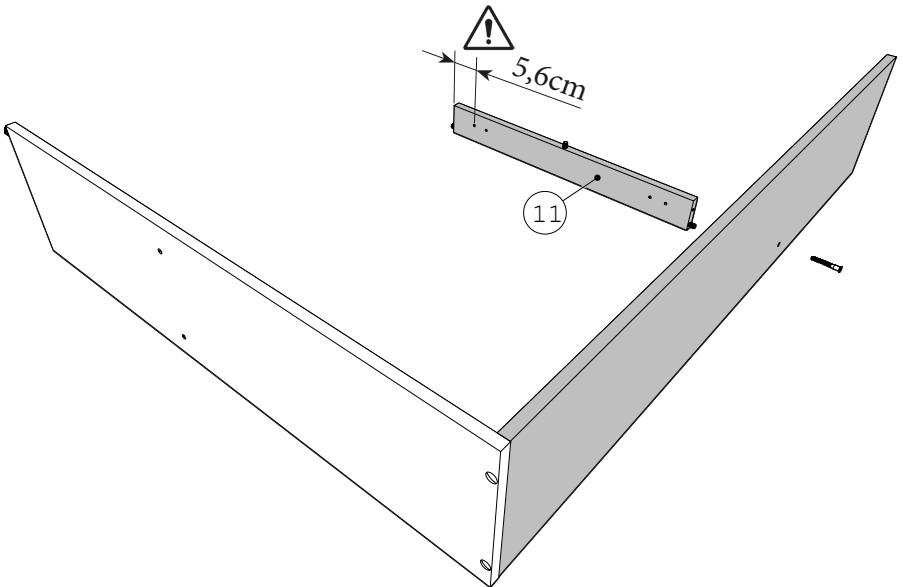
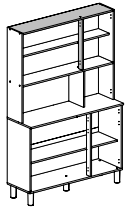
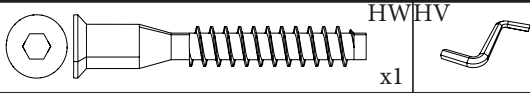
16

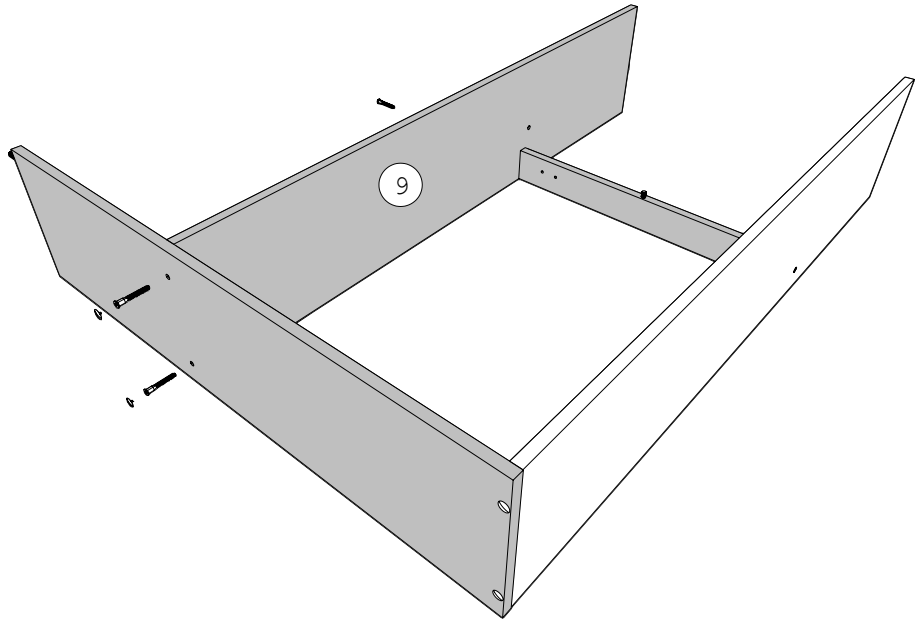
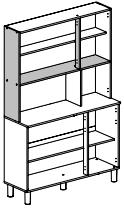
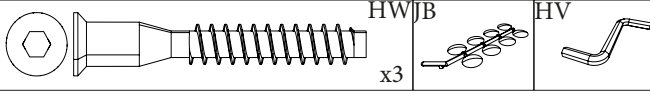

17

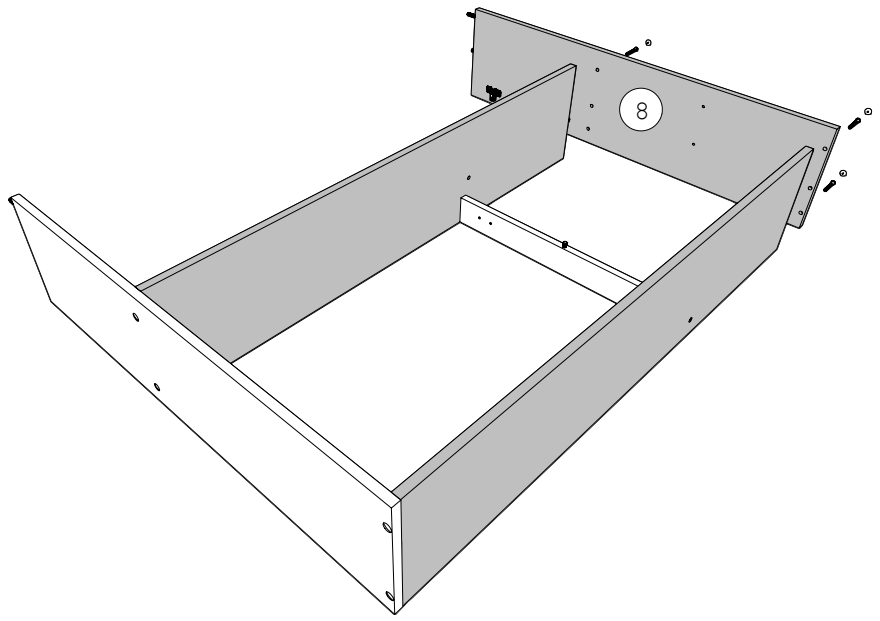
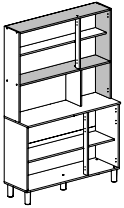
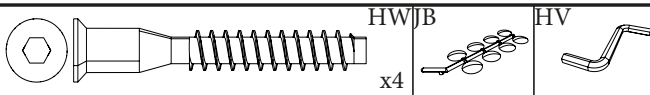

18

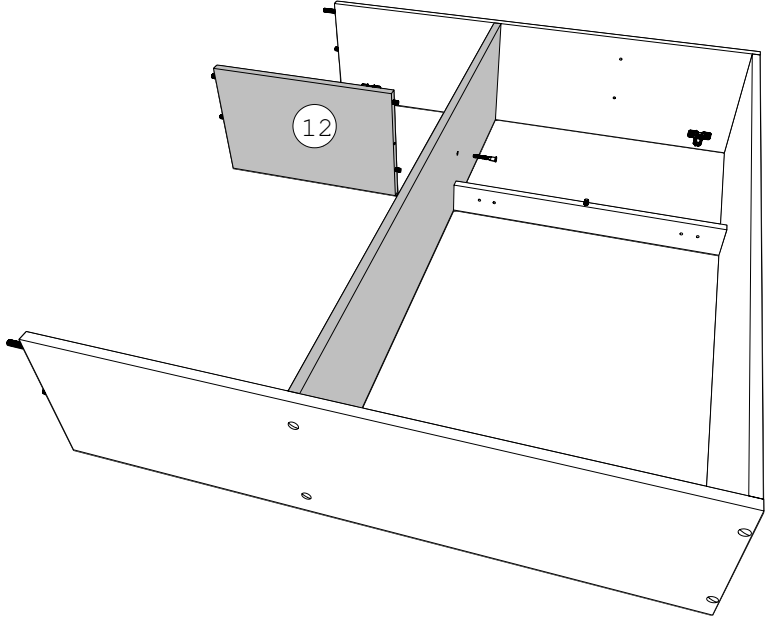
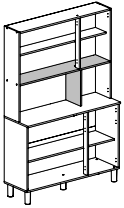
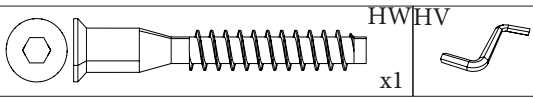

19

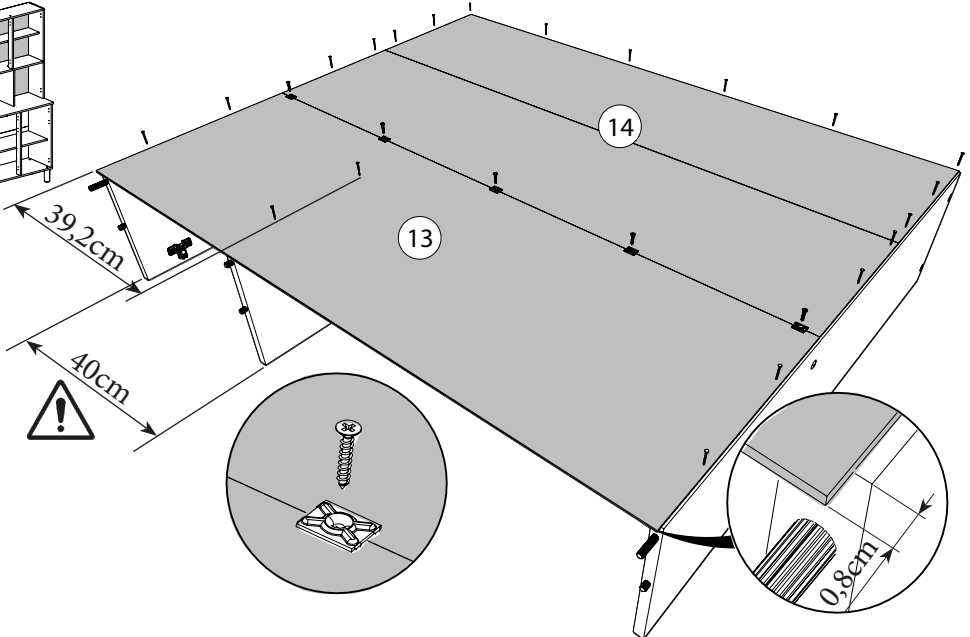
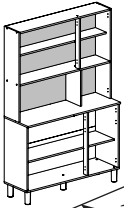
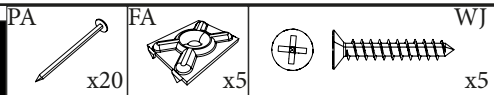

20

FA

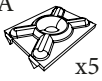

x5



WJ

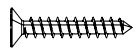

x5

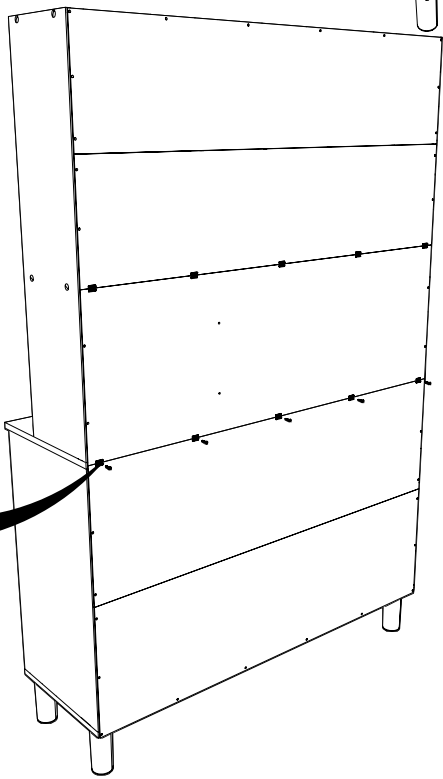
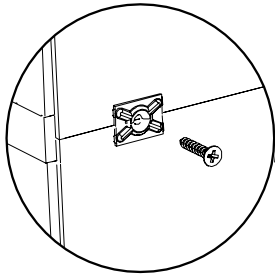
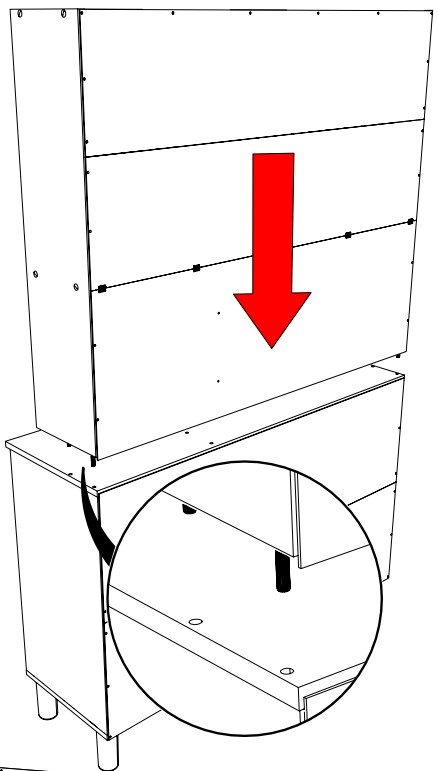
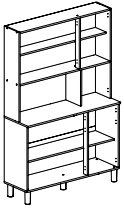

21

ZK



x1



VG



x2

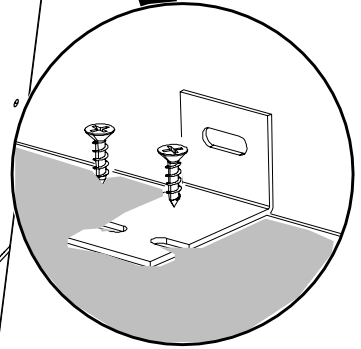
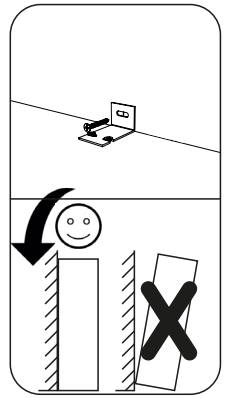
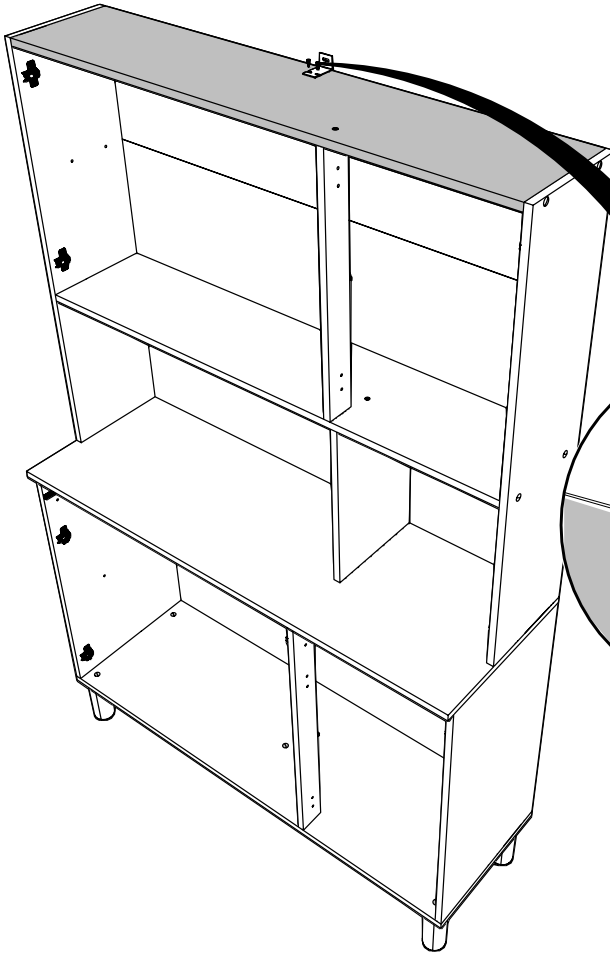
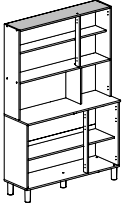

FR-Pour votre sécurité : Fixation du meuble au mur.

Attention, la fixation doit être réalisée par une personne compétente car cela nécessite des chevilles adaptées à la nature de votre mur.

EN-For your safety : the unit should be secured to the wall.

NB this should be carried out by a competent person as you must use the right rawl plug for your type of wall.

22 BWD x8

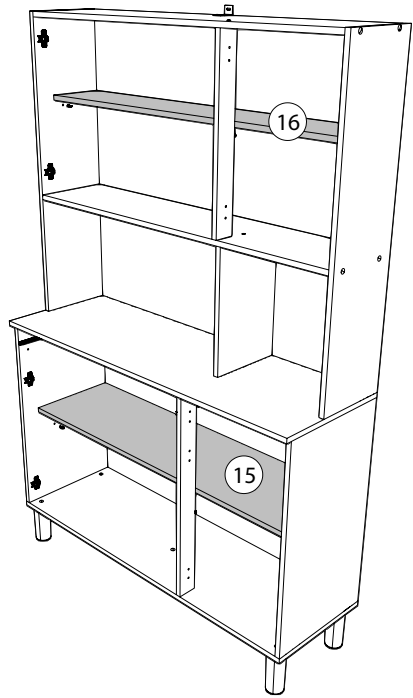
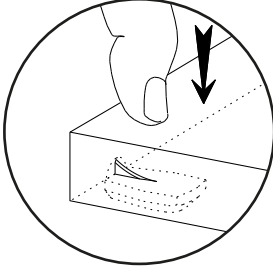
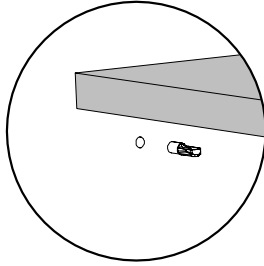
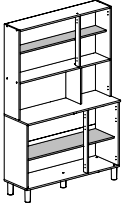

23 VR x2

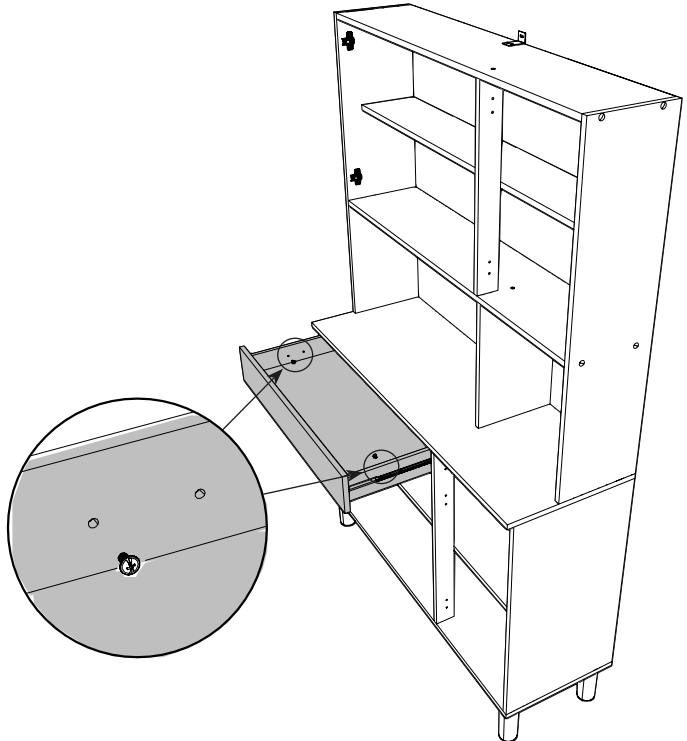
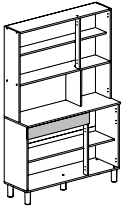
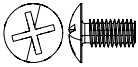

24

CDD



x2

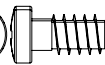

CDS

x4

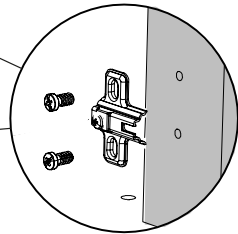
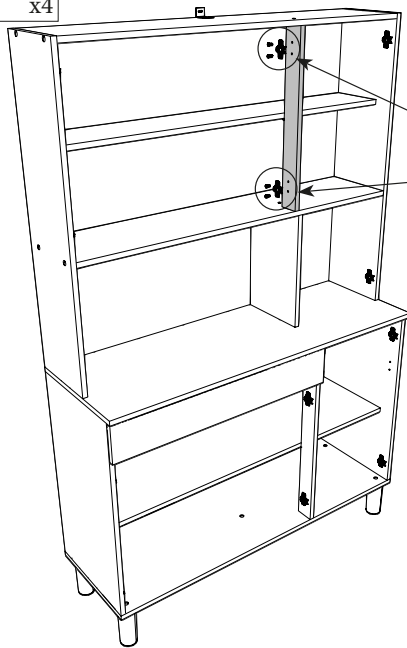
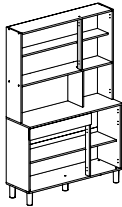

25

CDA



x12

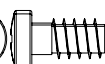

CDS

x24

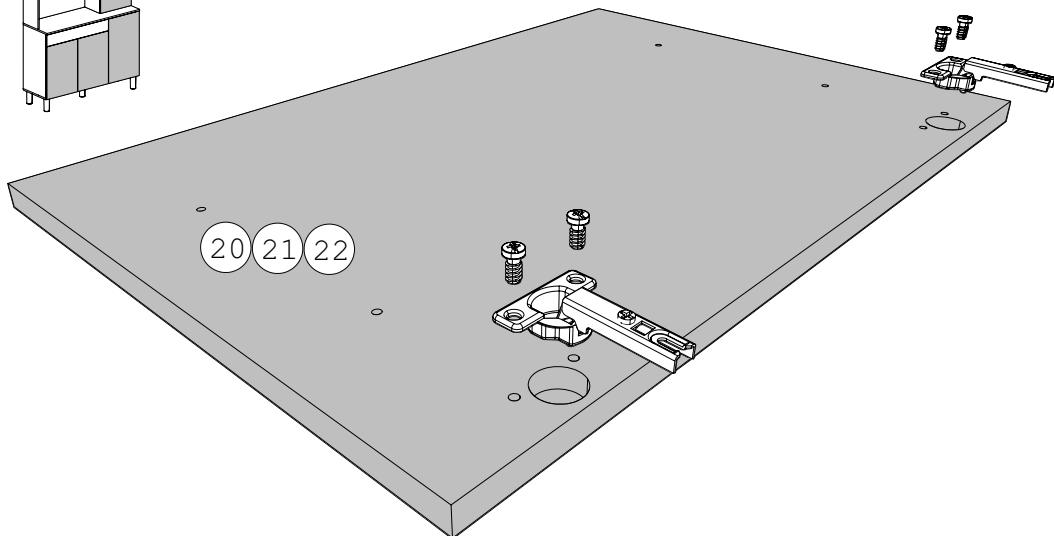
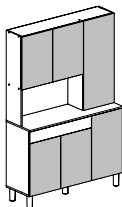

26

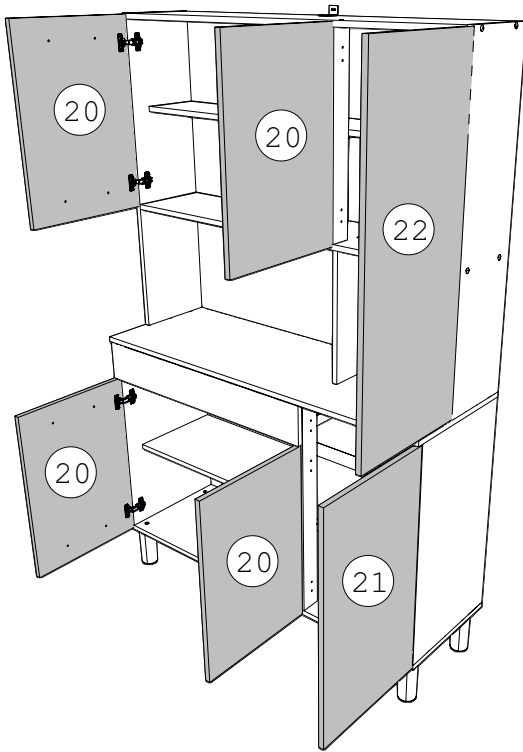
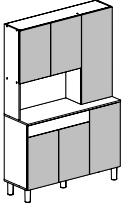

Charnières

<https://qrco.de/bc0wLm>

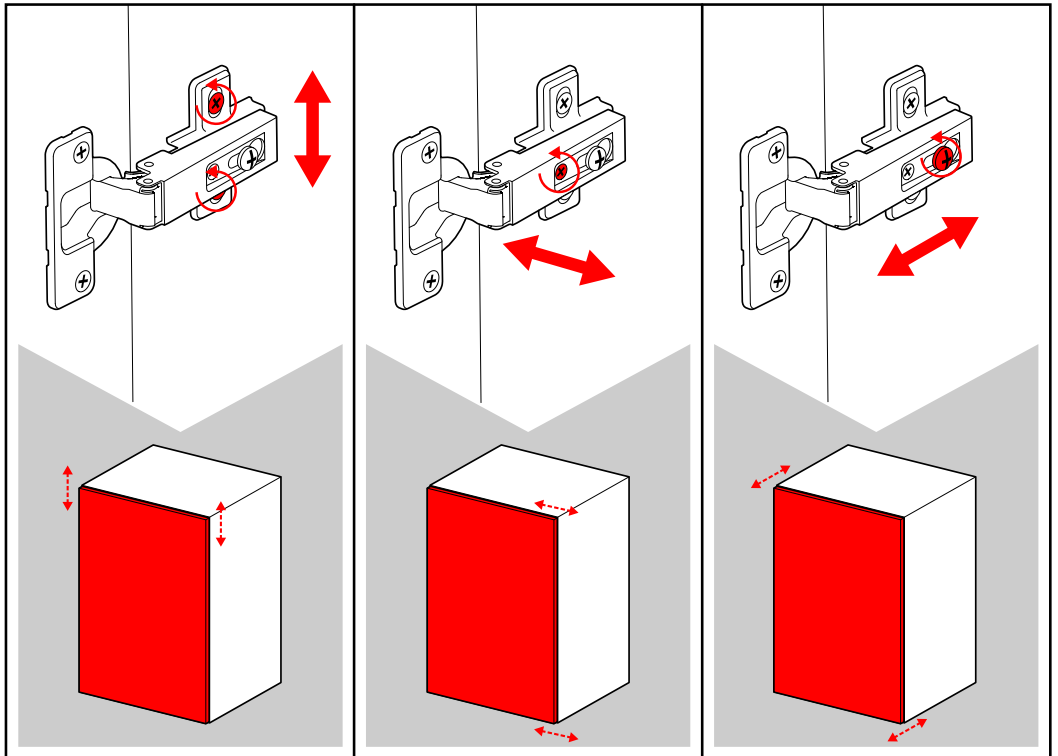

27

PB

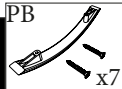

PAS

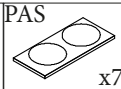

OO

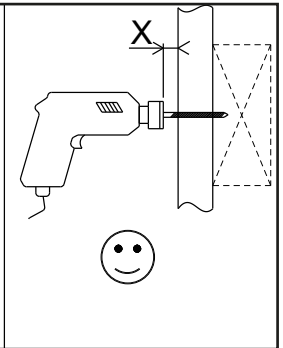
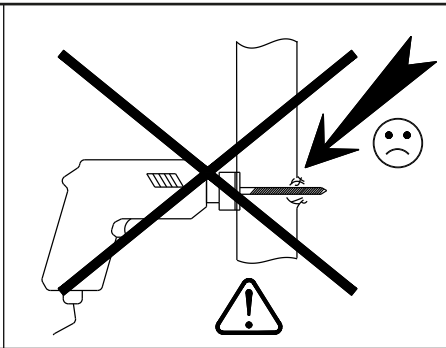
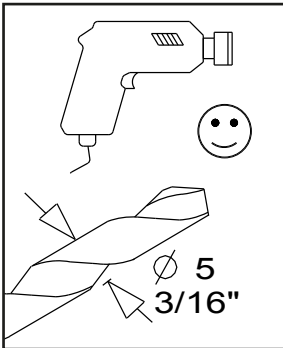
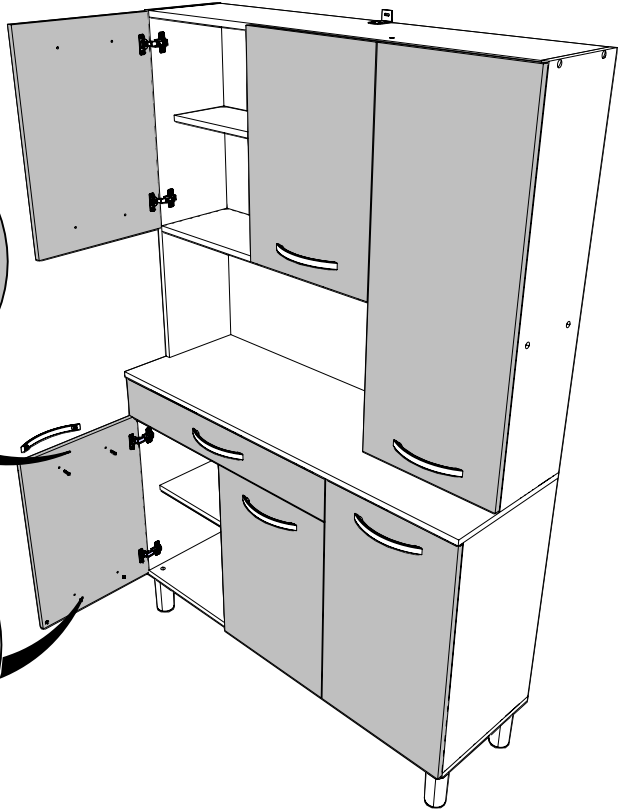
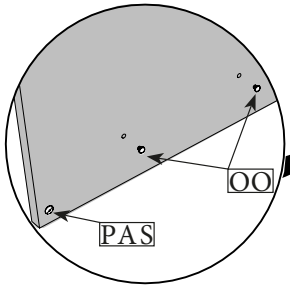
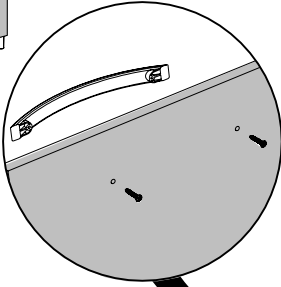
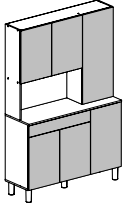
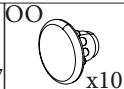

LE TRI + FACILE



FR

Pensez à donner ou recycler.



OU



OU



Déchèterie

<https://quefairedemesdechets.fr>