

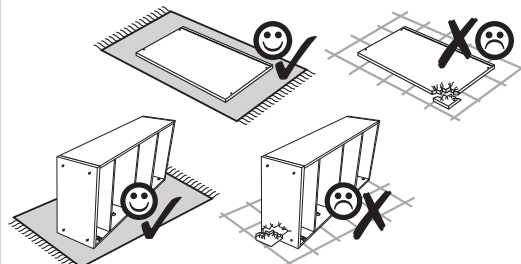

DETROIT 43

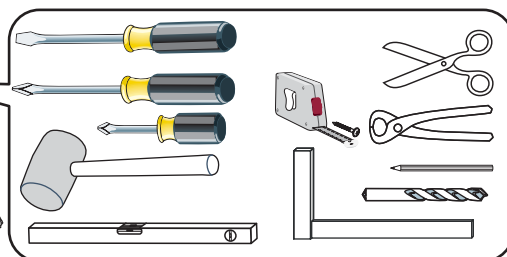

- Ⓚ Montageanleitung
- ⓃⓁ Handleiding voor de montage
- ⓉⓇ Montaj talimati
- ⓕ Instructions de montage
- ⒸⓏ Montá ní návod
- ⓗⓤ Összeszerelési útmutató
- ⓖⓑ Assembly instructions
- ⓅⓁ Instrukcja montażu
- Ⓡⓤ Инструкция по монтажу
- ⓇⓉ Istruzioni di montaggio
- ⓀⓂ Montá ny návod
- Ⓡⓐ Instrucțiuni de asamblare

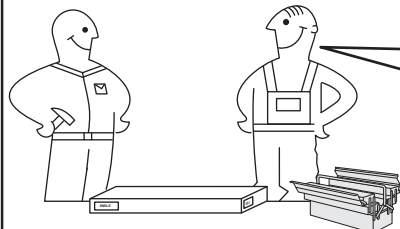
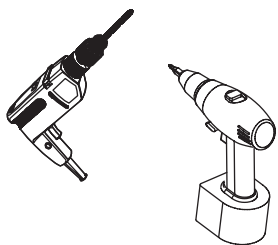
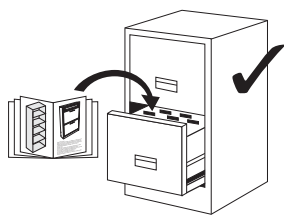
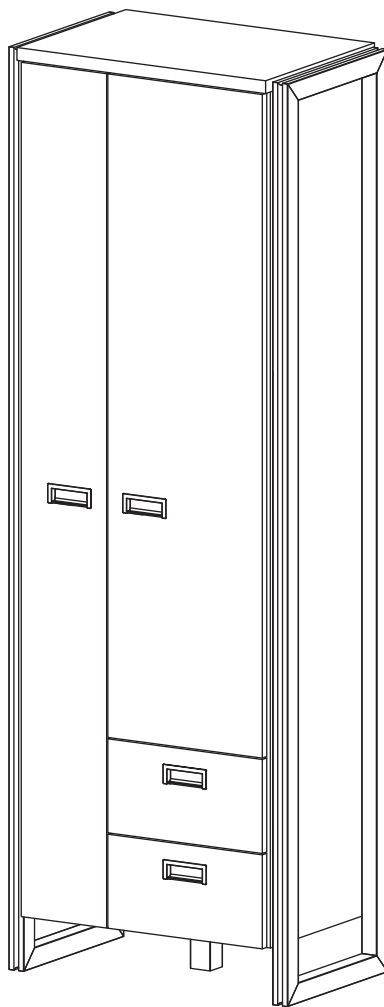
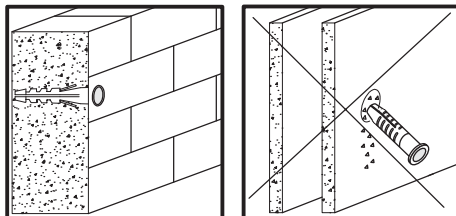
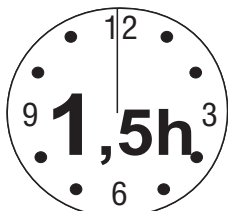
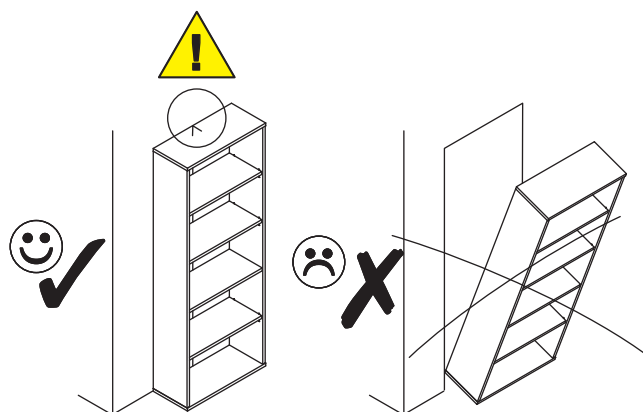



 Achtung • Opgelet • Uwaga • Dikkat • Внимание • Attention •Upozornění • Figyelem • Attenzione • Atenție 	
D	Überschreiten Sie angegebenen Maximalbelastungen nicht. Andernfalls kann das Möbelstück beschädigt oder zerstört werden.
GB	Do not exceed the maximum loads specified. Otherwise, the furniture may sustain damage or be irreparably damaged.
NL	Overschrijd de aangegeven maximale belastingen niet. Anders kan het meubelstuk worden beschadigd of vernield.
PL	Nie wolno przekraczać podanych maksymalnych wartości obciążenia. W przeciwnym razie mebel może zostać uszkodzony lub zniszczony.
TR	Belirtilen azami yük deđerini atmayınız, aksi takdirde mobilya parçaları zarar görebilir veya kullanılamaz hale gelebilir.
RU	Не допускается превышение указанных максимальных нагрузок. В противном случае возможно повреждение или разрушение мебели.
FR	Ne dépassez pas les charges maximum indiquées. Sinon, le meuble peut être endommagé ou détruit.
CZ	Nepřekračujte uvedená maximální zatížení. V opačném případě může dojít k poškození nebo zničení nábytku.
HU	Tartsa be az engedélyezett maximális terhelhetőséget/teljesítményt. Különben a bútor és annak alkatrészei megsérülhetnek, tönkre mehetnek.
IT	Non superare il carico massimo indicato. Altrimenti il mobile rischia di rovinarsi o frantumarsi.
RO	Nu depășiți solicitările maxime specificate. Altfel puteți să deteriorați sau să distrugeți piesa de mobilier.
SK	Neprekročte uvedené maximálne zaťaženia. V opačnom prípade sa môže nábytok poškodiť alebo zničiť.
D	Die Befestigung des Möbelstückes an der Wand muss von einer fachkundigen Person vorgenommen werden, da für die Montage an die Wand angepasste Dübel erforderlich sind.
GB	A qualified professional is required when mounting furniture to the wall since dowels corresponding to the wall are required for this.
NL	Een vakkundige persoon dient het meubelstuk aan de muur te bevestigen; voor de montage aan de muur zijn immers aangepaste pluggen vereist.
PL	Mocowanie mebla do ściany mogą przeprowadzić wyłącznie wykwalifikowane osoby, z uwagi na zastosowanie odpowiednio dopasowanych kołków do rodzaju ściany.
TR	Mobilya parçasının duvara sabitlenmesi, duvar montajı için özel uyarlanmış dübeller gerektirdiğinden bu iş sadece bu konuda uzman bir kişi tarafından gerçekleştirilmelidir.
RU	Поскольку для монтажа на стене необходимо использовать специальные дюбели, мебель должна быть закреплена на стене квалифицированным персоналом.
FR	La fixation du meuble contre le mur doit être effectuée par une personne compétente car, pour le montage mural, il faut utiliser des chevilles adaptées.
CZ	Montáž nábytku na stěnu musí provést odborník, protože k montáži na stěnu jsou zapotřebí upravené hmoždinky.
HU	A bútorlemek falra rögzítését szakembernek kell végeznie, mert a rögzítéshez megfelelő tiplít kell használni.
IT	Il fissaggio del mobile alla parete deve essere eseguito da persone esperte, dato che occorrono tasselli adeguati.
RO	Fixarea la perete a piesei de mobilier se realizează numai de către personal competent, deoarece montajul de perete necesită dibluri adecvate.
SK	Upevnenie nábytku na stenu musí vykonať odborník, nakoľko sú pre montáž na stenu potrebné vhodné hmoždinky.

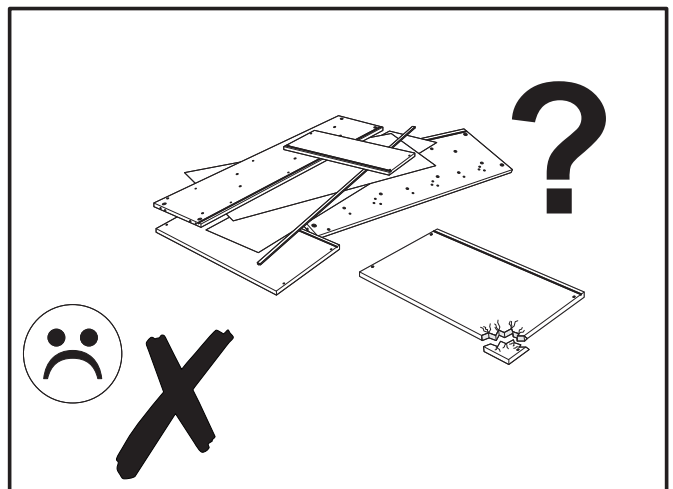
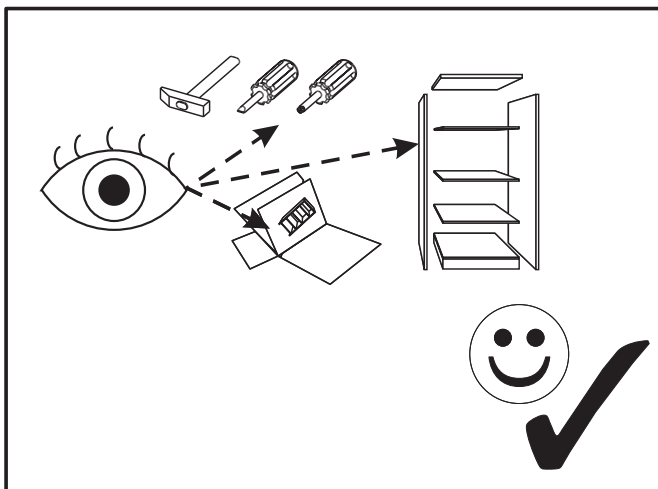
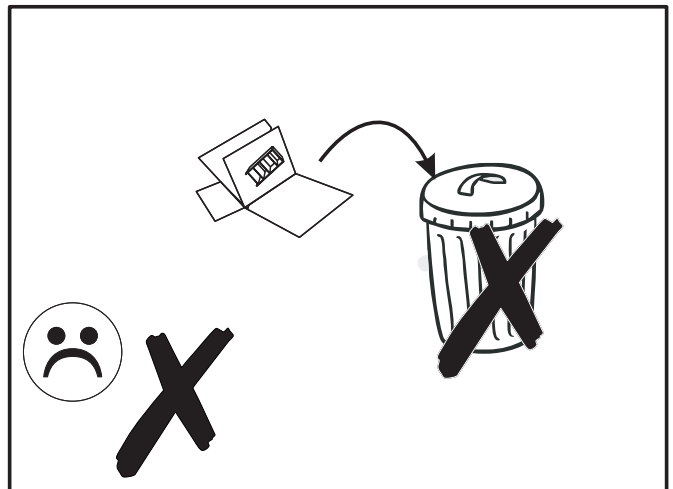
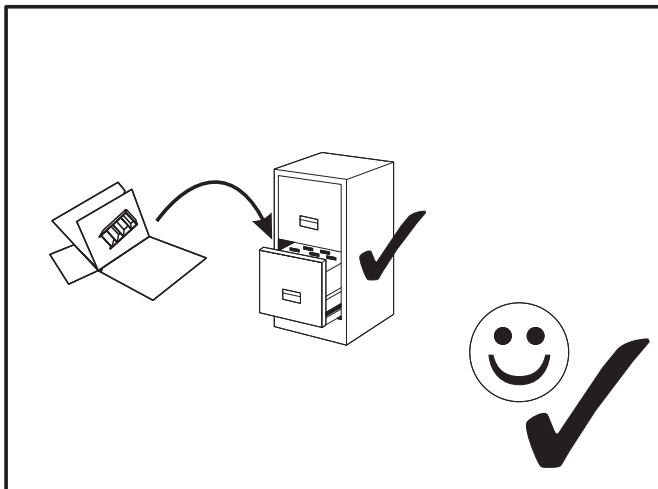
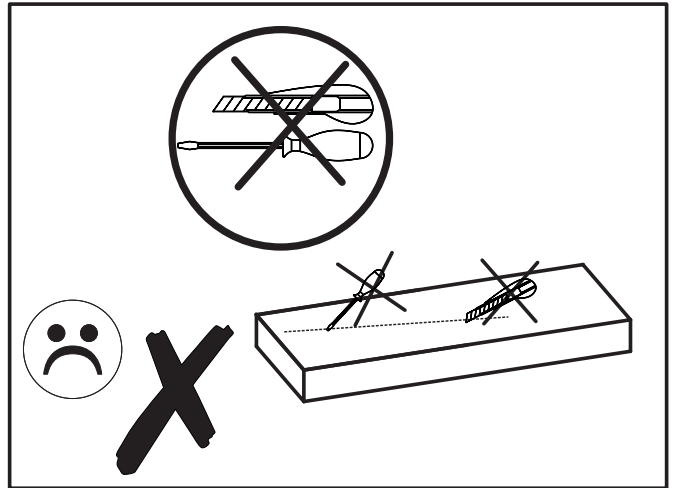
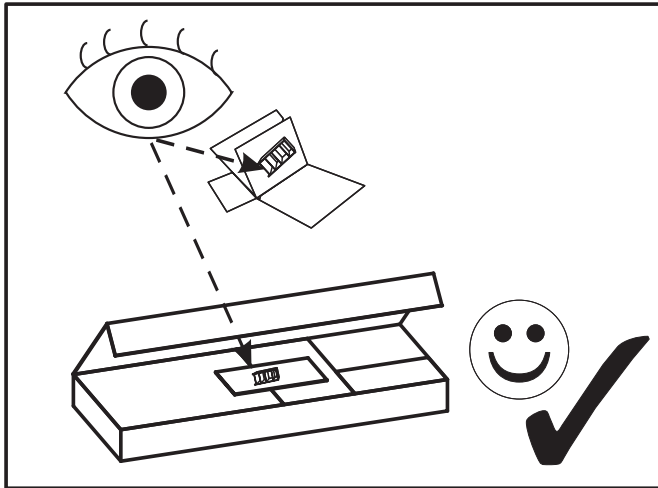



DETROIT 43

MM
260
250
240
230
220
210
200
190
180
170
160
150
140
130
120
110
100
90
80
70
60
50
40
30
20
10
0

NR 1

B1  $\phi 8 \times 28$ x58

M1  x6

T1  x6

K1  7x50 x14

C6  x8

J23  x12

P3  3x20 x14

L13  x8

W1  x12

C7  x4

NR 2

U276  x4

P13  3,5x13 x8

NR 3

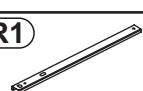
R1  L-245/27 x4

A1  M4x9 x4

E6  6,3x9,5 x8

P5  4x30 x4

NR 4

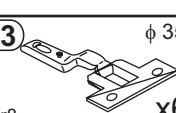
Z3  $\phi 35$ Kr8 x6

Y4  H2 x6

S3  3,5x13 x12

NR 5

F15  $\phi 28$ x5

P6  4x30 x16

NR 6

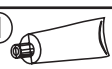
L1  x1

NR 7

P13  3,5x13 x2

J11  x1

NR 8

WW350  x1

S3  3,5x13 x4

NR 9

18  x1

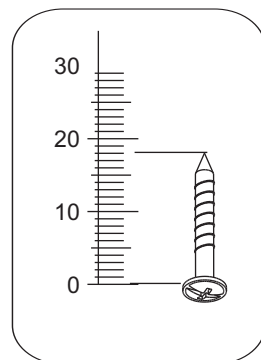

1

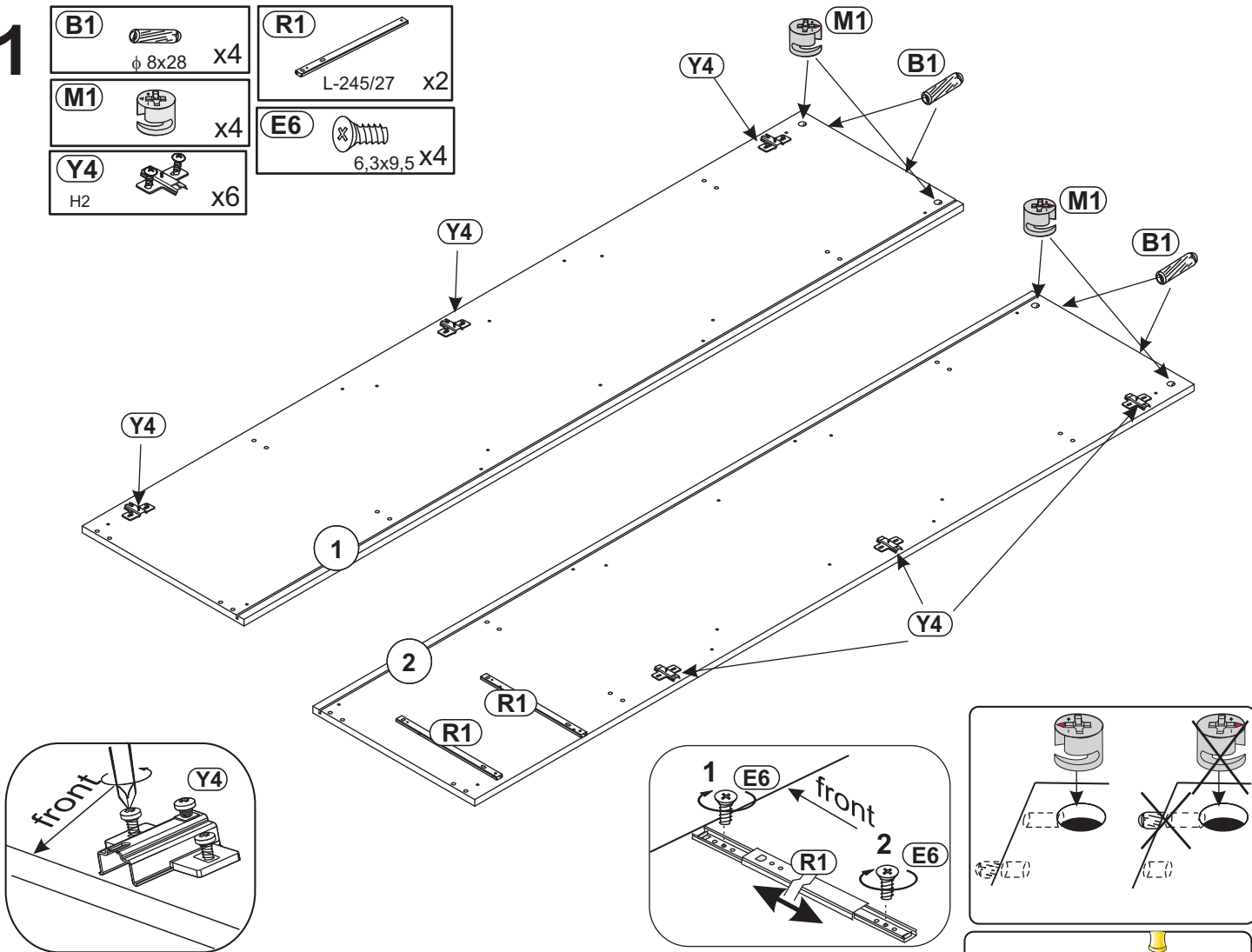
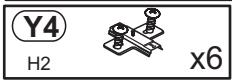
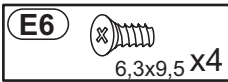
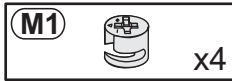
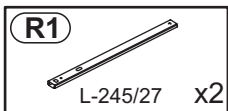

2

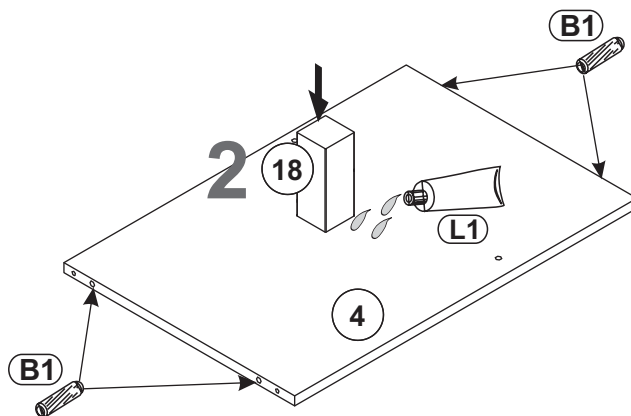
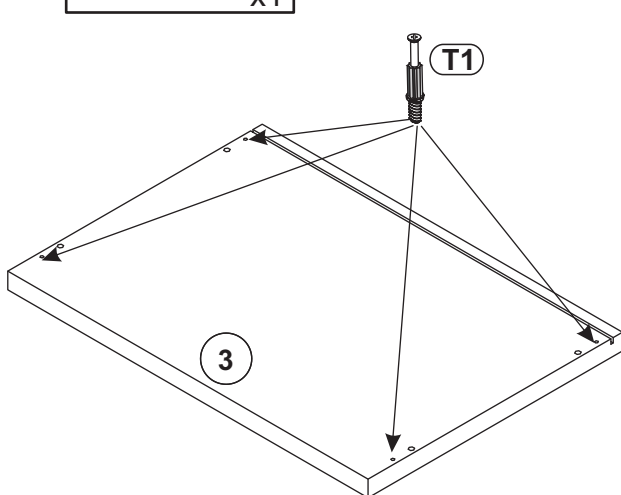
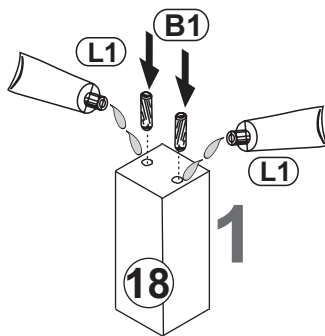
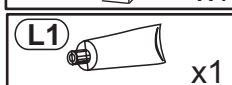
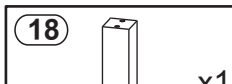
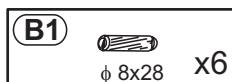
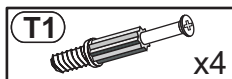

3

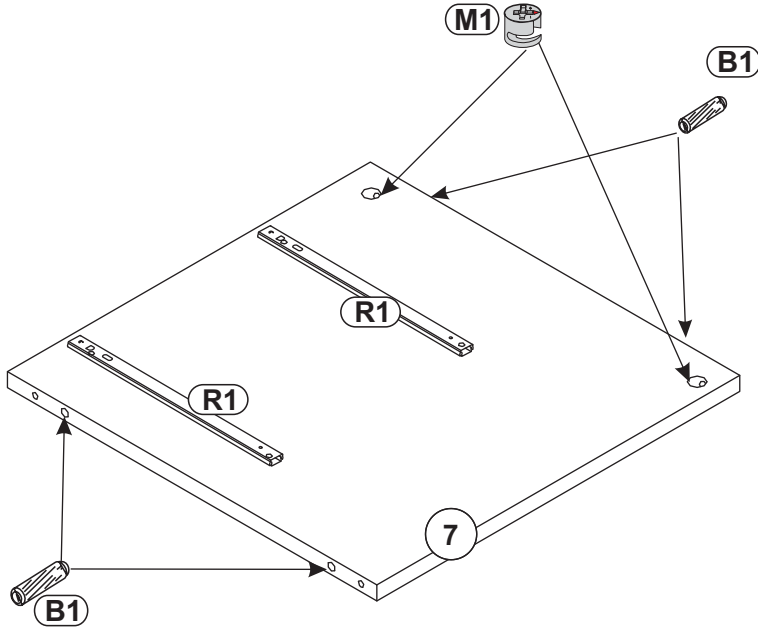



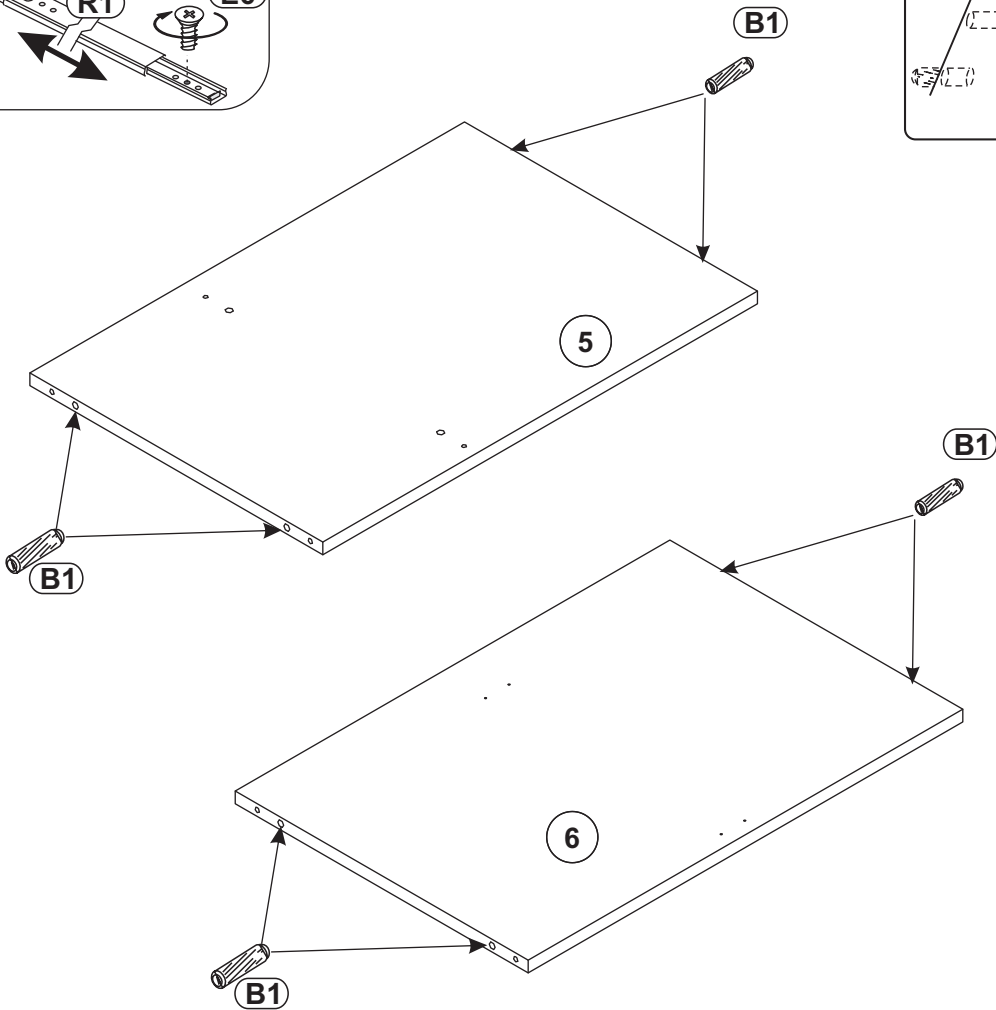
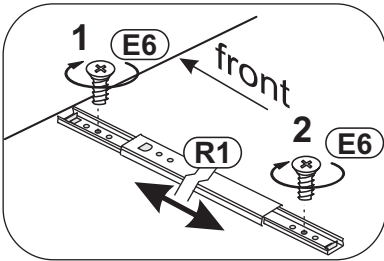
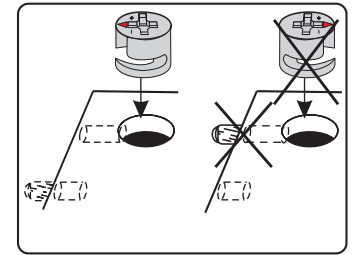
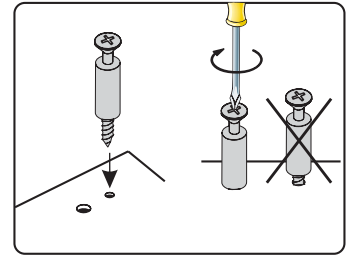

- R1** L-245/27 x2
- E6** 6,3x9,5 X4
- B1** ϕ 8x28 x12
- M1** x2

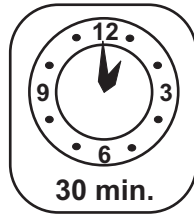

4



- U276**  x2
- P13**  3,5x13 x4
- L1**  x1
- B1**  ϕ 8x28 x20
- P5**  4x30 x4

A

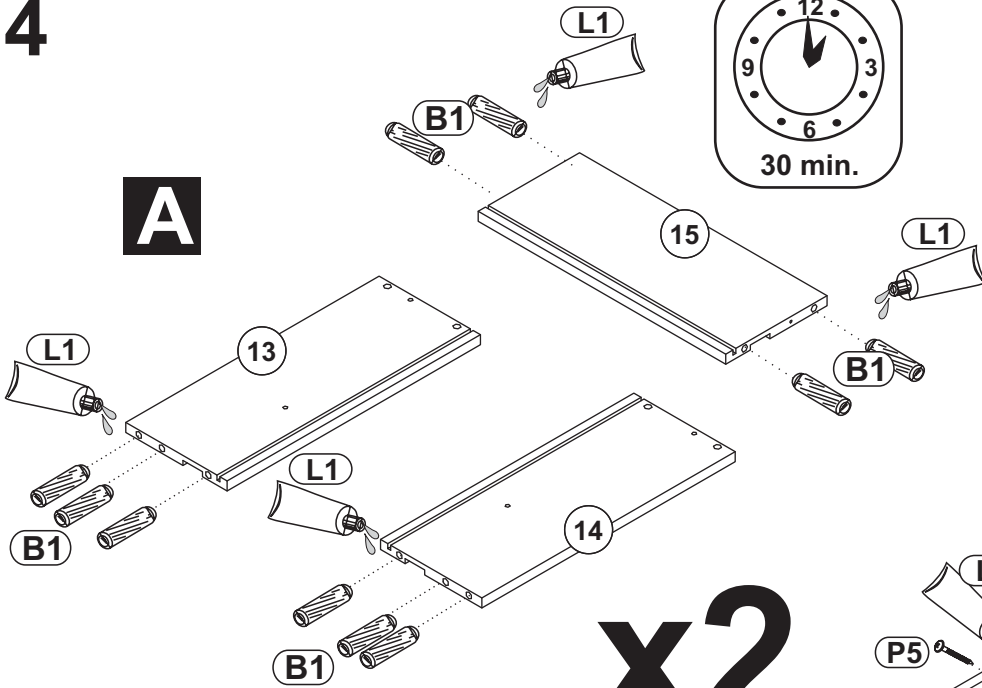

x2

B

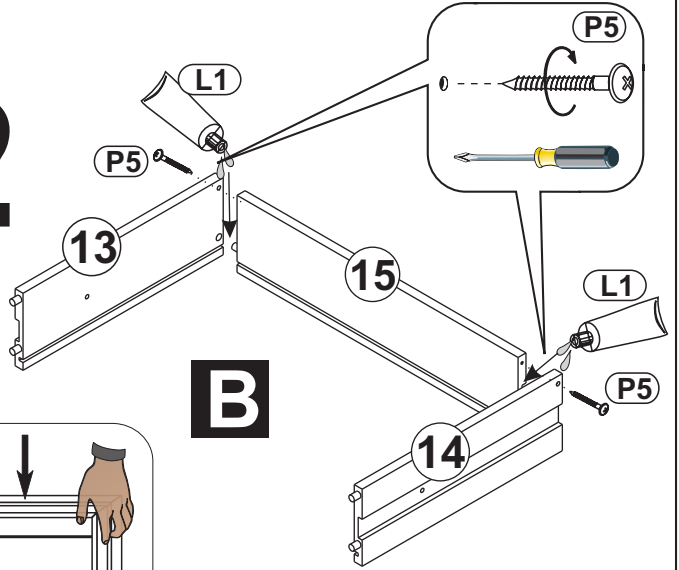

C

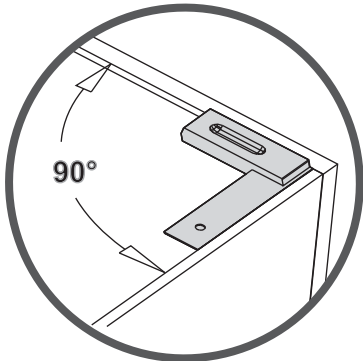
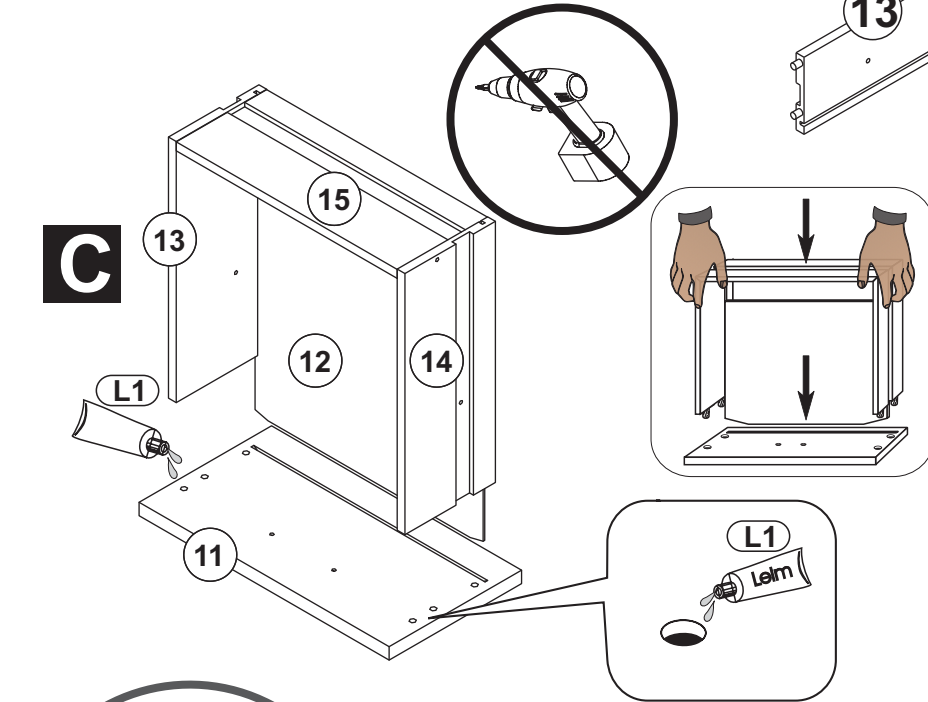

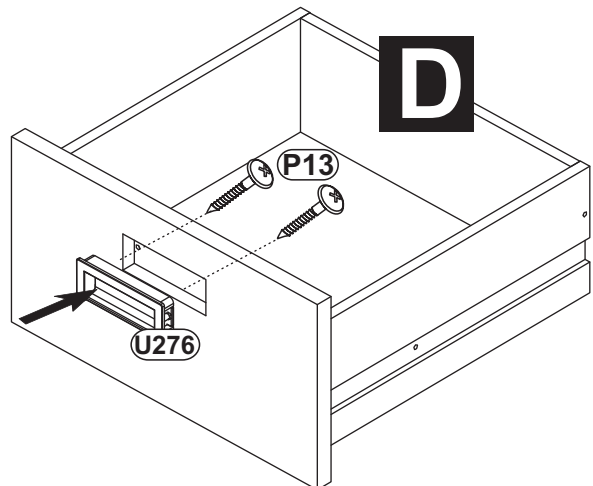

D

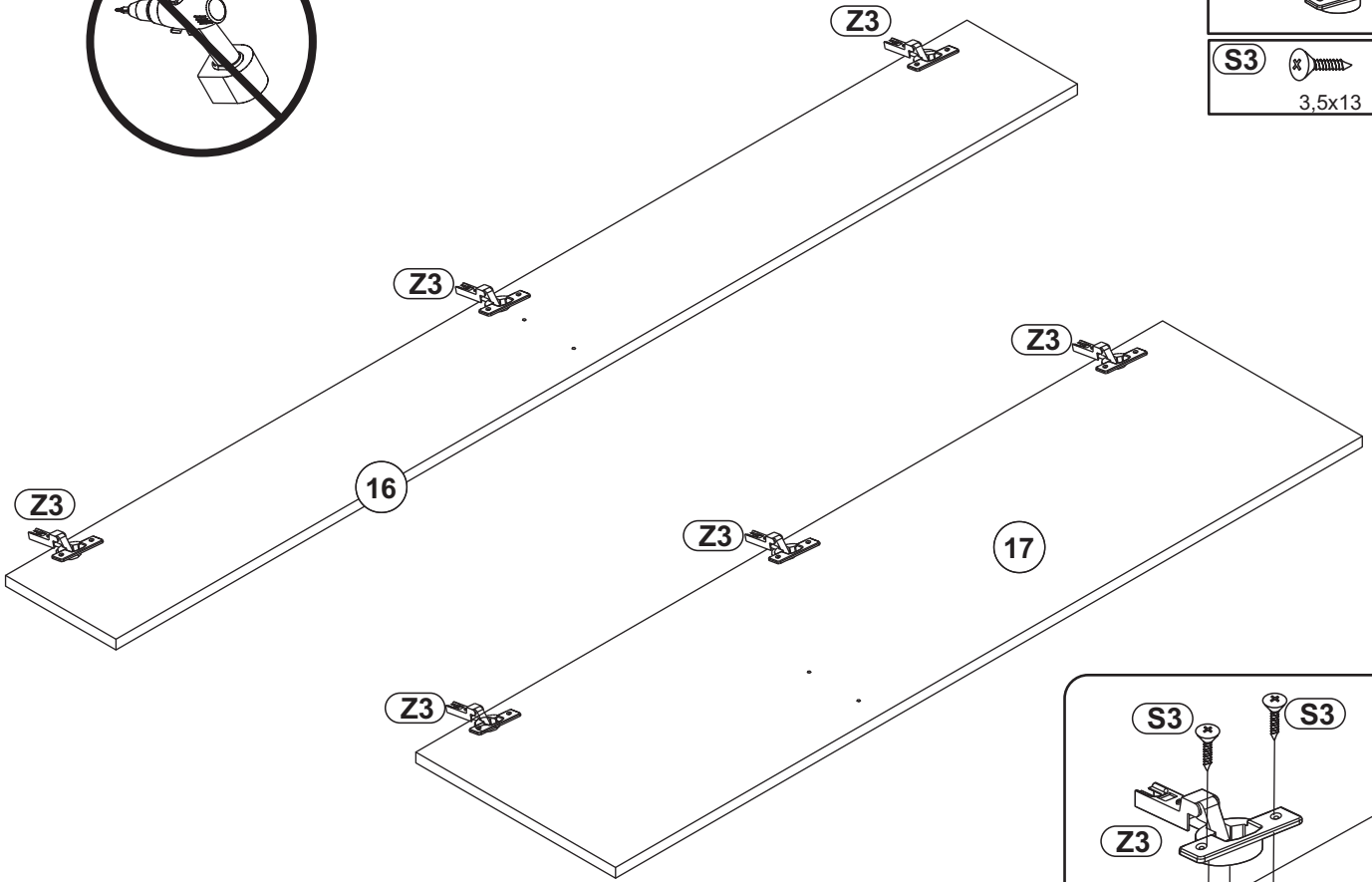
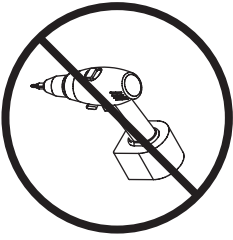

5



Z3		x6
S3		3,5x13 x12

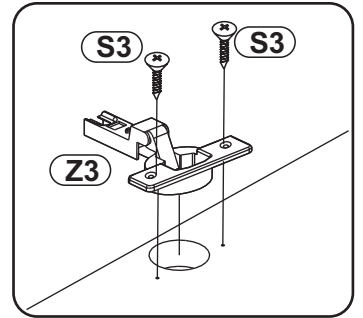

6

K1		x2
7x50		

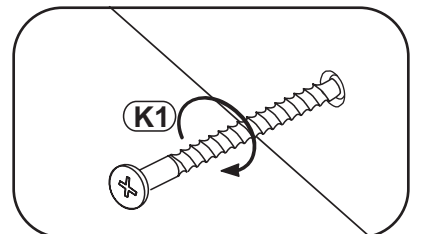
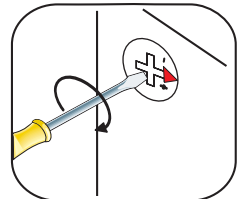
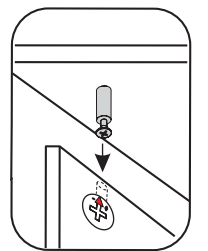
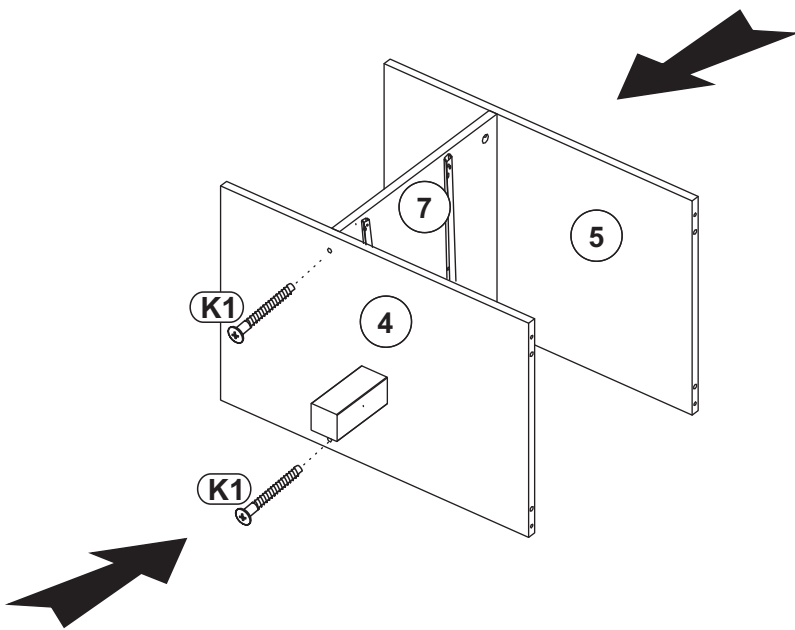

7

K1 
7x50 x12

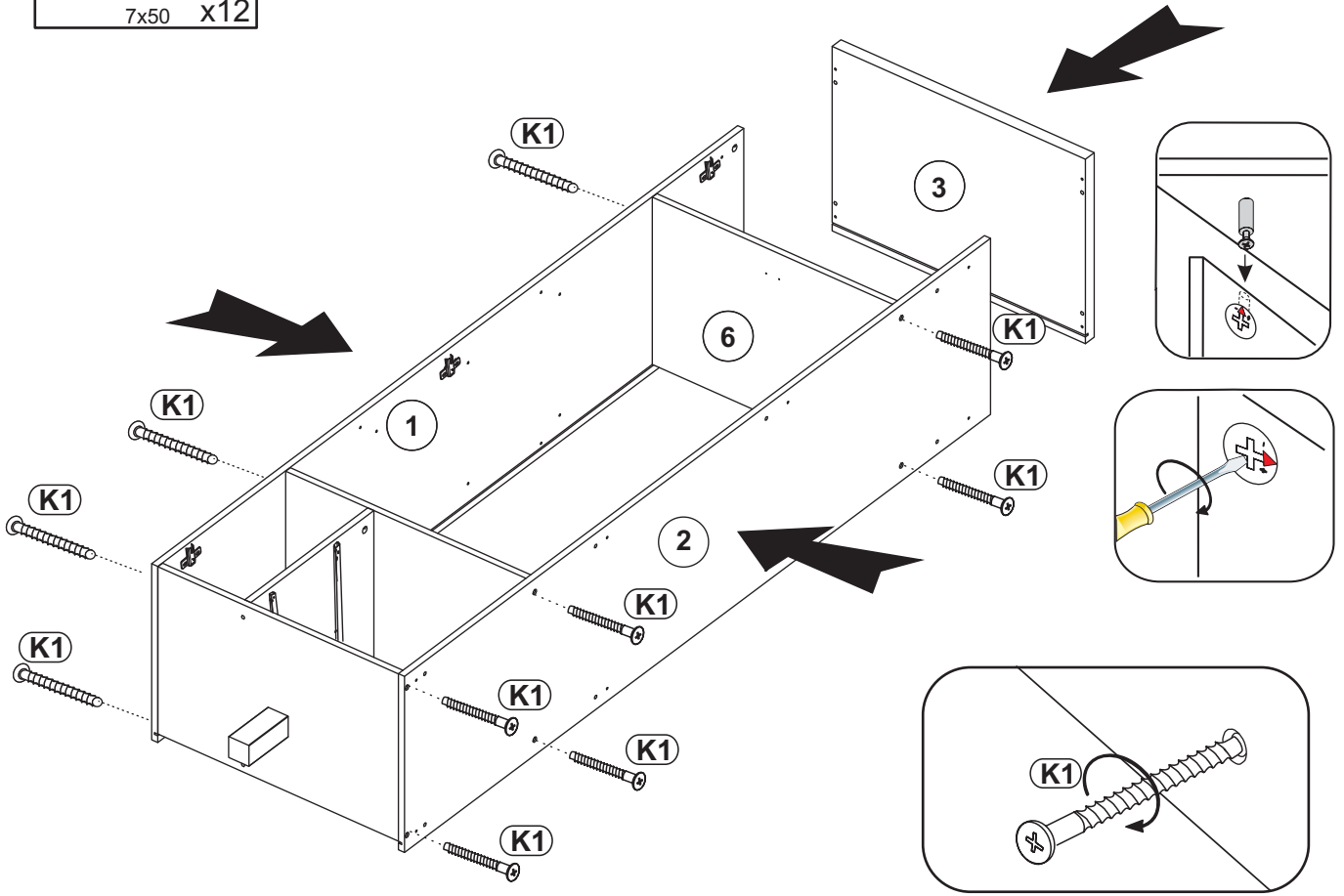

8

B1 
φ 8x28 x16

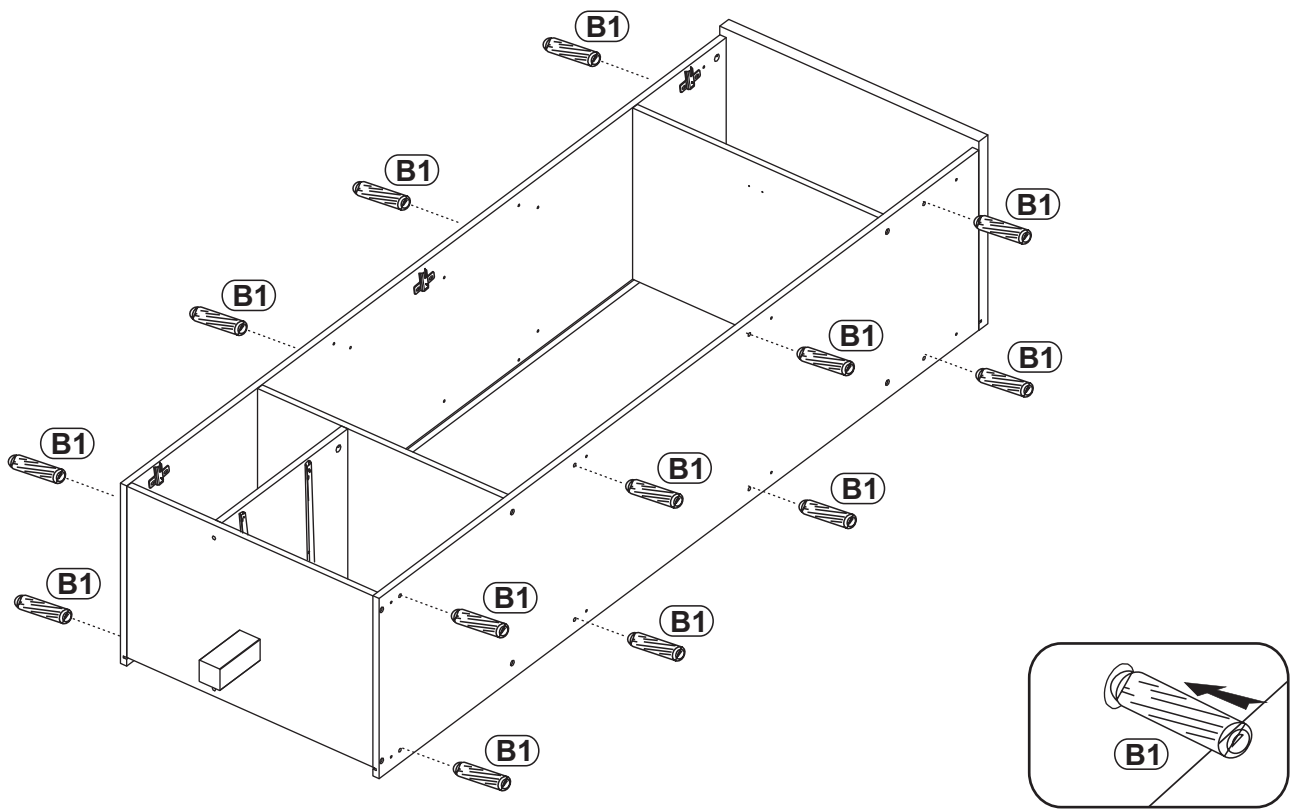

9

P6 4x30 x16

F15 ϕ 28 x5

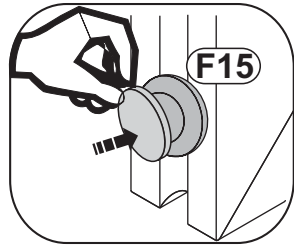
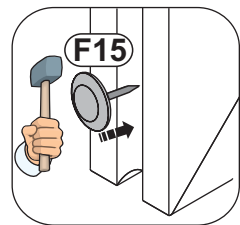
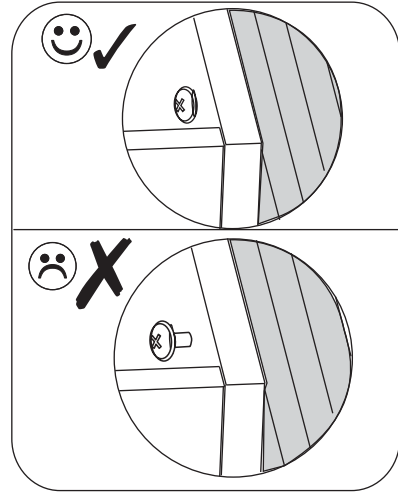
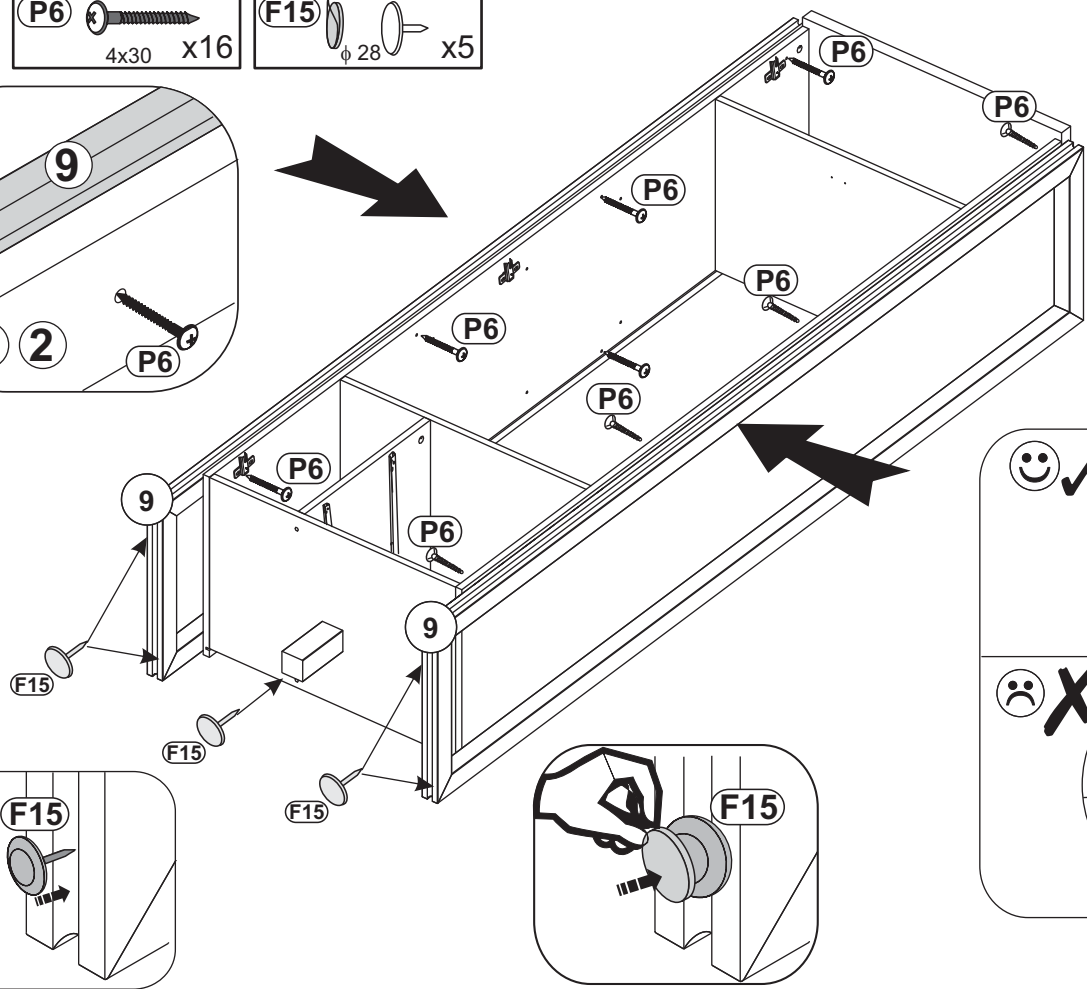
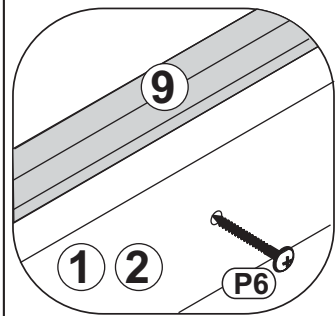

10

C7 x4

P3 3x20 x12

J23 x14

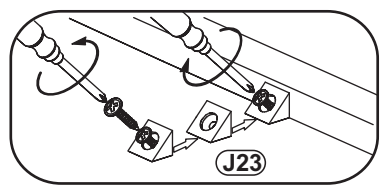
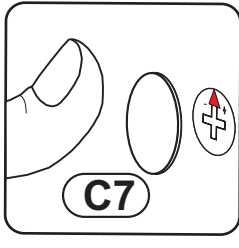
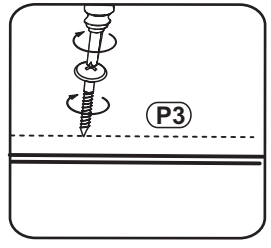
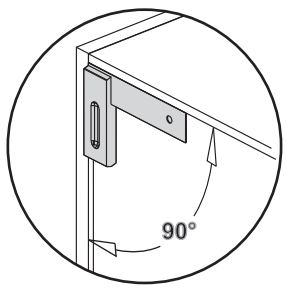
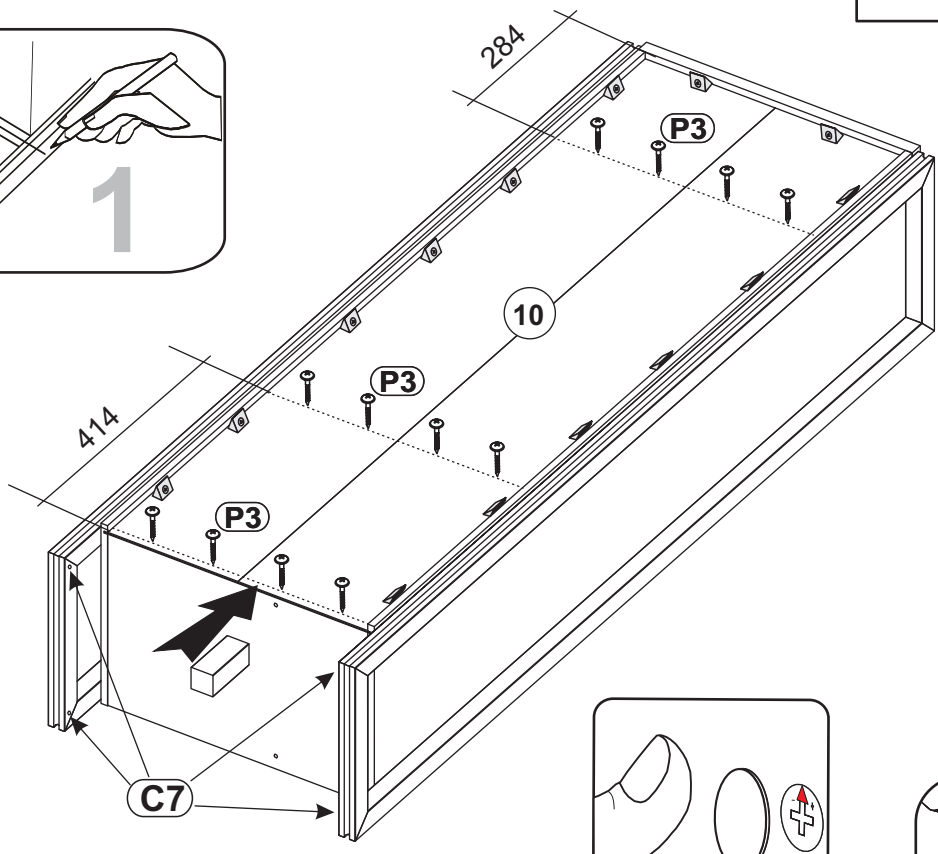
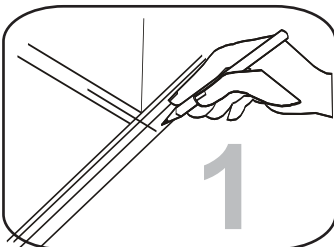

11

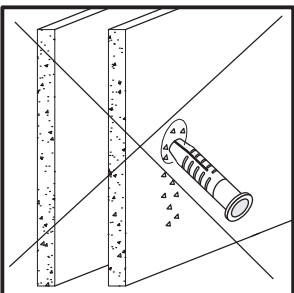
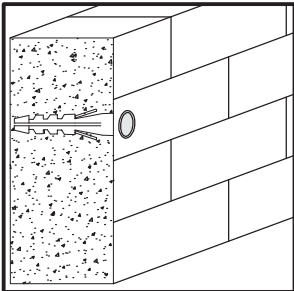
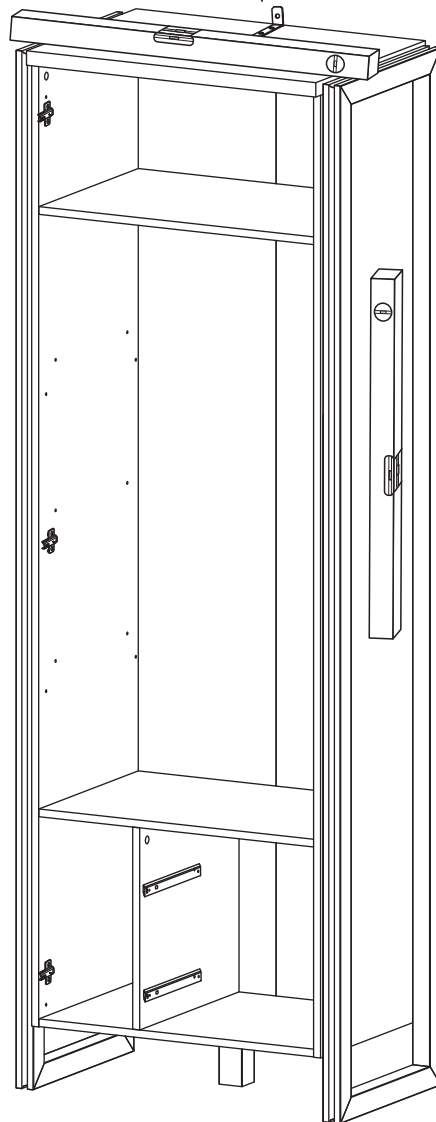
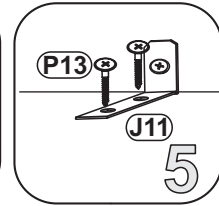
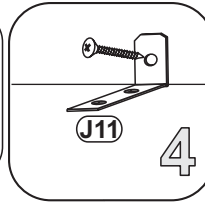
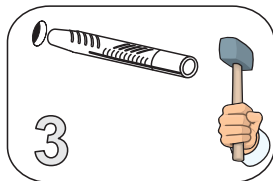
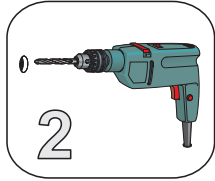
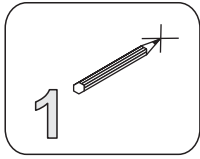
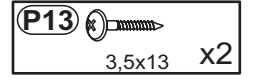
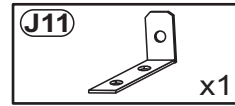

12

option :A



option :B

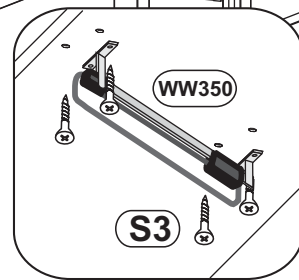
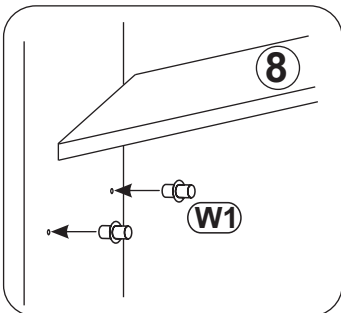
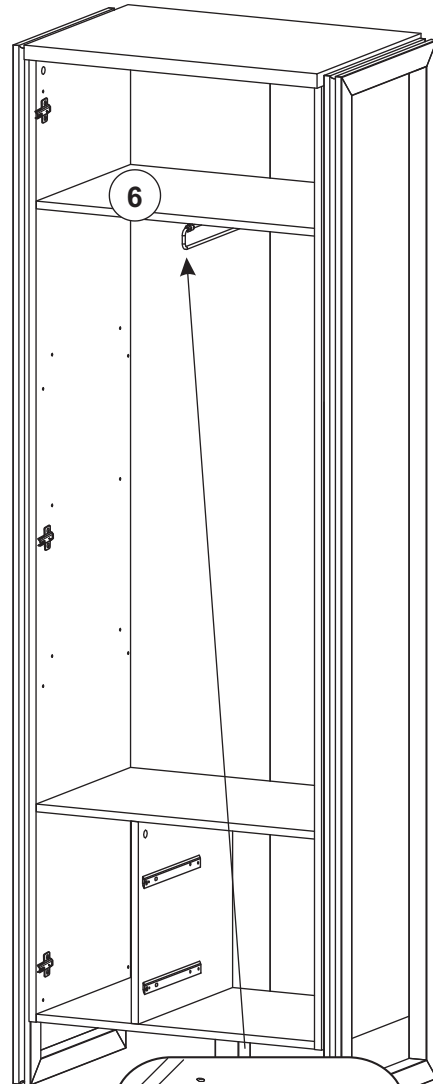
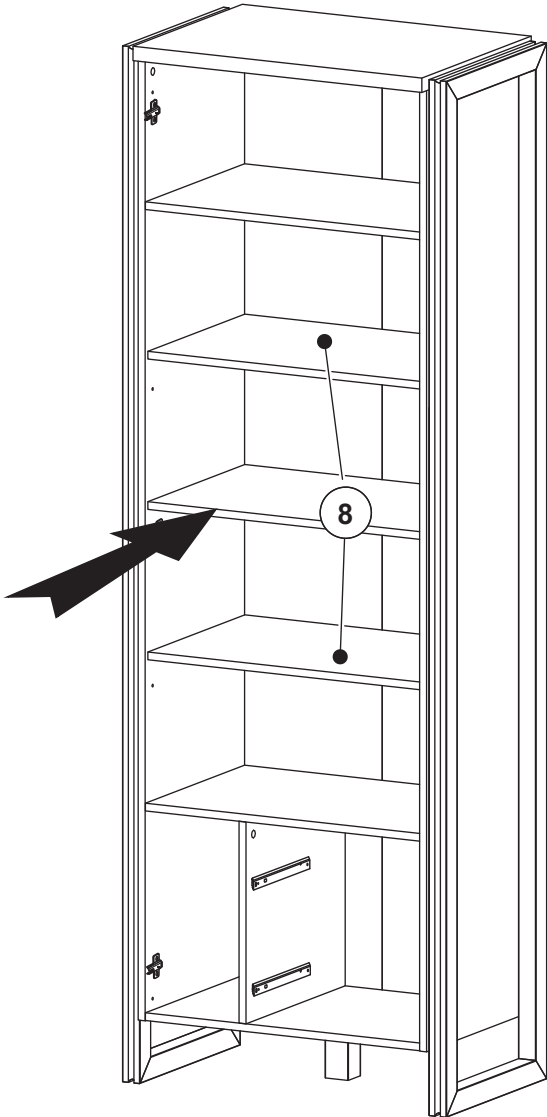

13

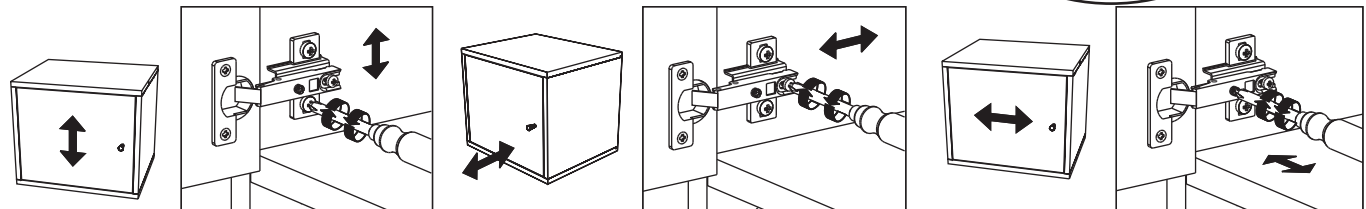
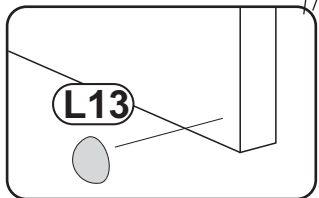
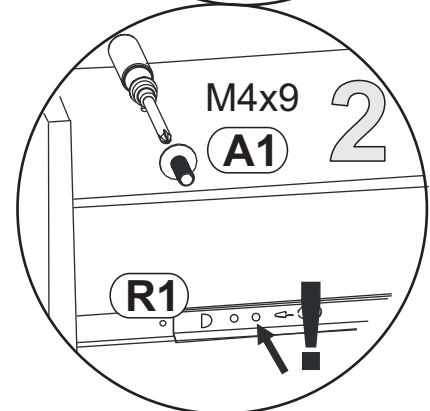
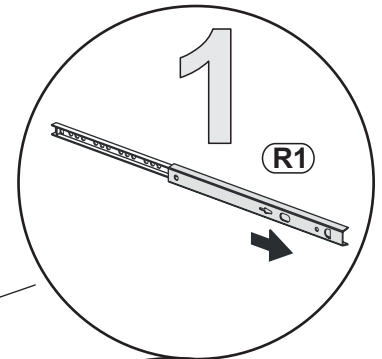
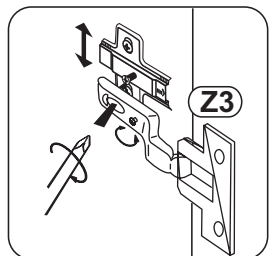
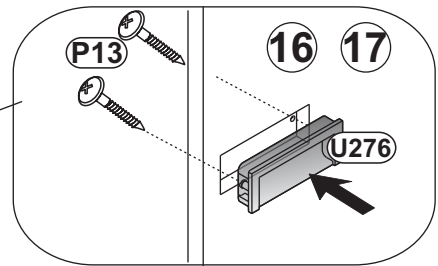
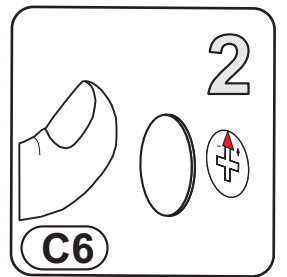
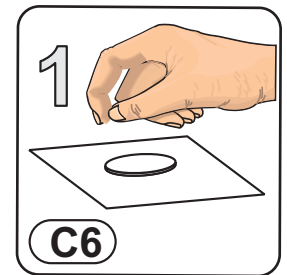
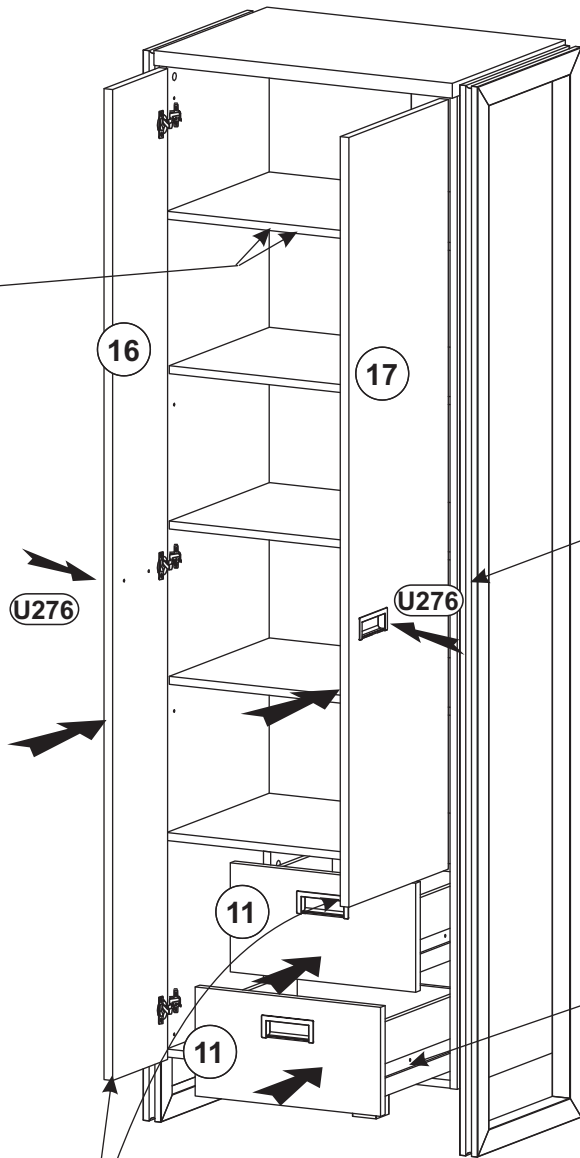
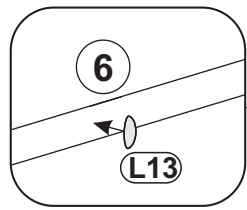
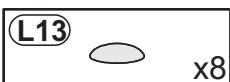
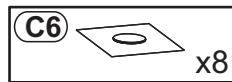
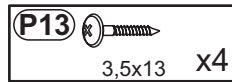
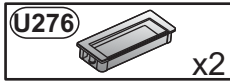

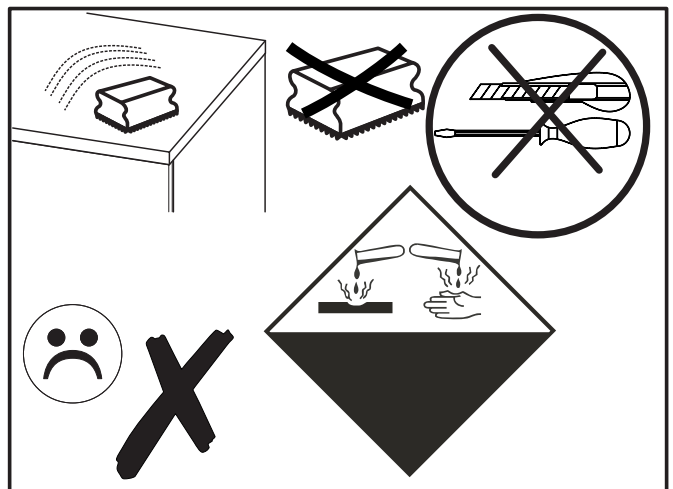
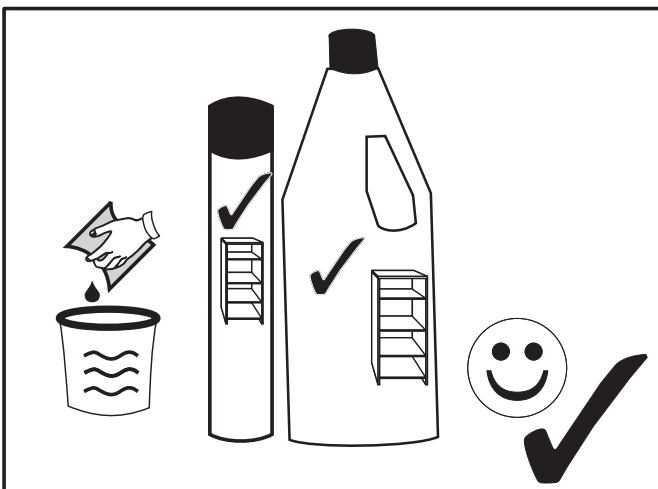
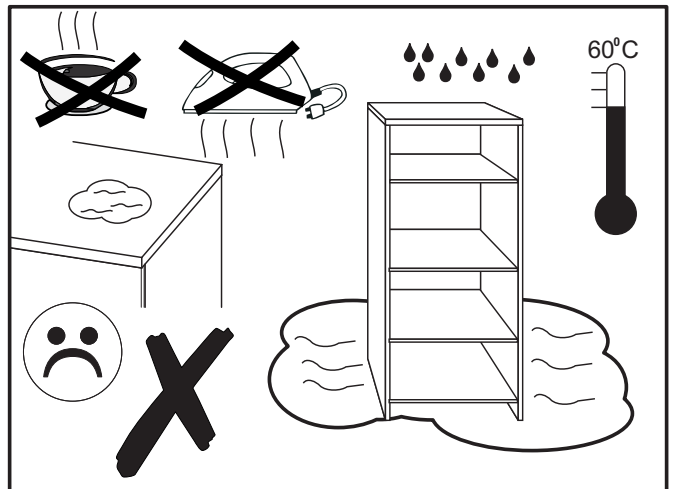
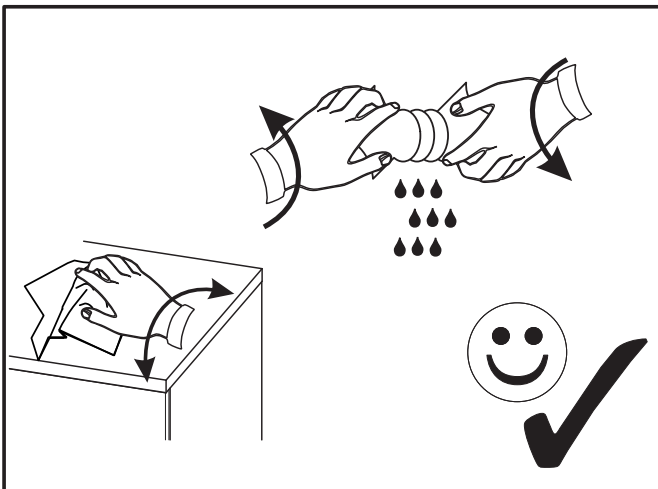
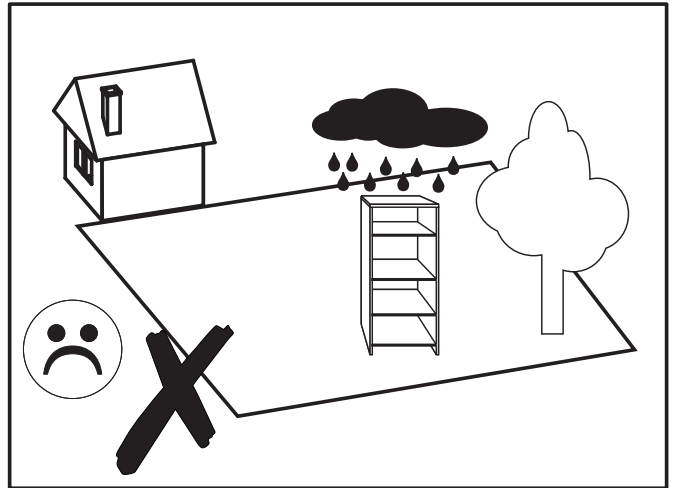
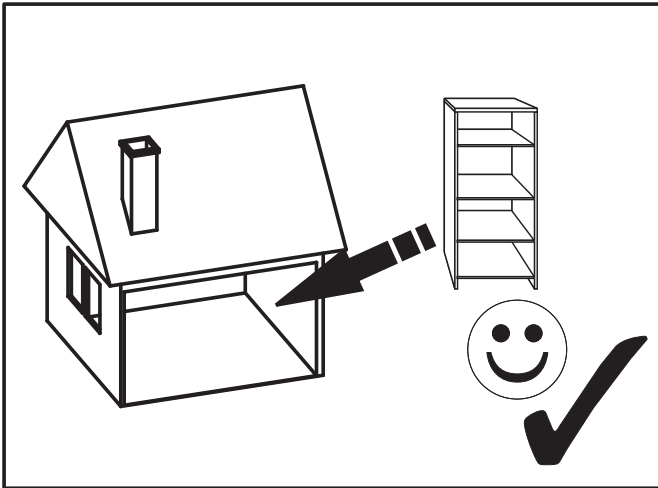

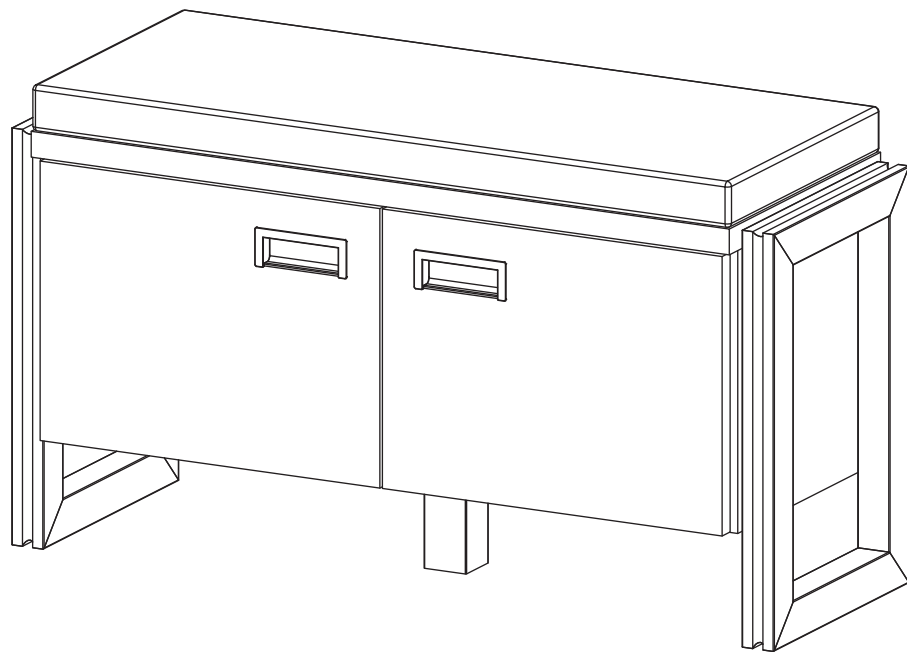
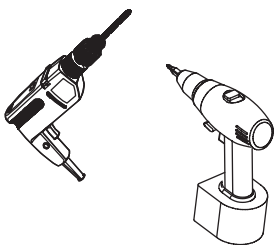
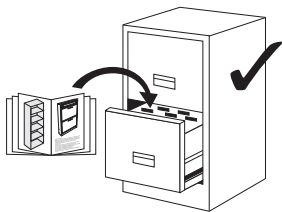
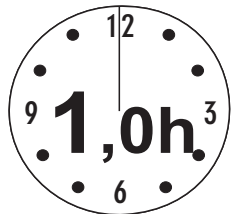

DETROIT 79

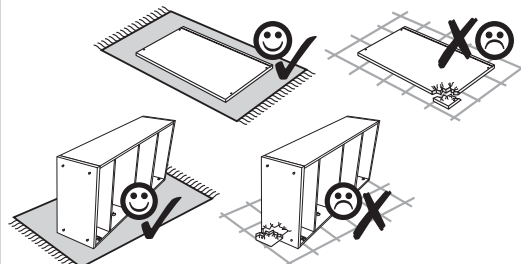
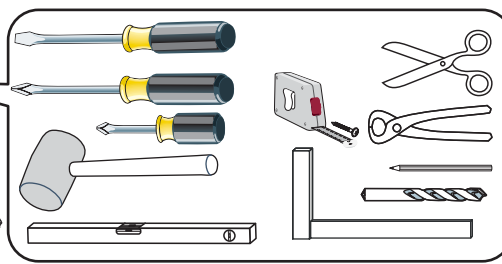
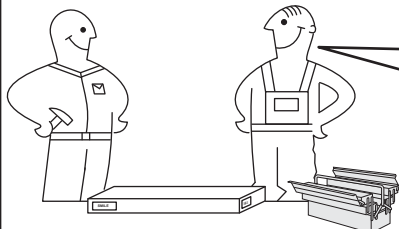

- Ⓚ Montageanleitung
- ⓃⓁ Handleiding voor de montage
- ⓉⓇ Montaj talimati
- ⓕ Instructions de montage
- ⒸⓏ Montá ní návod
- ⓗⓤ Összeszerelési útmutató
- ⓖⓑ Assembly instructions
- Ⓟ Instrukcja montażu
- Ⓡⓤ Инструкция по монтажу
- ⓇⓉ Istruzioni di montaggio
- ⓀⓂ Montá ny návod
- Ⓡⓞ Instrucțiuni de asamblare



 Achtung • Opgelet • Uwaga • Dikkat • Внимание • Attention •Upozornění • Figyelem • Attenzione • Atenție 	
D	Überschreiten Sie angegebenen Maximalbelastungen nicht. Andernfalls kann das Möbelstück beschädigt oder zerstört werden.
GB	Do not exceed the maximum loads specified. Otherwise, the furniture may sustain damage or be irreparably damaged.
NL	Overschrijd de aangegeven maximale belastingen niet. Anders kan het meubelstuk worden beschadigd of vernield.
PL	Nie wolno przekraczać podanych maksymalnych wartości obciążenia. W przeciwnym razie mebel może zostać uszkodzony lub zniszczony.
TR	Belirtilen azami yük deđerini atmayınız, aksi taktirde mobilya parçaları zarar görebilir veya kullanılamaz hale gelebilir.
RU	Не допускается превышение указанных максимальных нагрузок. В противном случае возможно повреждение или разрушение мебели.
FR	Ne dépassez pas les charges maximum indiquées. Sinon, le meuble peut être endommagé ou détruit.
CZ	Nepřekračujte uvedená maximální zatížení. V opačném případě může dojít k poškození nebo zničení nábytku.
HU	Tartsa be az engedélyezett maximális terhelhetőséget/teljesítményt. Különben a bútor és annak alkatrészei megsérülhetnek, tönk्रे mehetnek.
IT	Non superare il carico massimo indicato. Altrimenti il mobile rischia di rovinarsi o frantumarsi.
RO	Nu depășiți solicitările maxime specificate. Altfel puteți să deteriorați sau să distrugeți piesa de mobilier.
SK	Neprekročte uvedené maximálne zaťaženia. V opačnom prípade sa môže nábytok poškodiť alebo zničiť.
<hr/>	
D	Die Befestigung des Möbelstückes an der Wand muss von einer fachkundigen Person vorgenommen werden, da für die Montage an die Wand angepasste Dübel erforderlich sind.
GB	A qualified professional is required when mounting furniture to the wall since dowels corresponding to the wall are required for this.
NL	Een vakkundige persoon dient het meubelstuk aan de muur te bevestigen; voor de montage aan de muur zijn immers aangepaste pluggen vereist.
PL	Mocowanie mebla do ściany mogą przeprowadzić wyłącznie wykwalifikowane osoby, z uwagi na zastosowanie odpowiednio dopasowanych kołków do rodzaju ściany.
TR	Mobilya parçalarının duvara sabitlenmesi, duvar montajı için özel uyarlanmış dübeller gerektirdiğinden bu iş sadece bu konuda uzman bir kişi tarafından gerçekleştirilmelidir.
RU	Поскольку для монтажа на стене необходимо использовать специальные дюбели, мебель должна быть закреплена на стене квалифицированным персоналом.
FR	La fixation du meuble contre le mur doit être effectuée par une personne compétente car, pour le montage mural, il faut utiliser des chevilles adaptées.
CZ	Montáž nábytku na stěnu musí provést odborník, protože k montáži na stěnu jsou zapotřebí upravené hmoždinky.
HU	A bútorrelemek falra rögzítését szakembernek kell végeznie, mert a rögzítéshez megfelelő tiplít kell használni.
IT	Il fissaggio del mobile alla parete deve essere eseguito da persone esperte, dato che occorrono tasselli adeguati.
RO	Fixarea la perete a piesei de mobilier se realizează numai de către personal competent, deoarece montajul de perete necesită dibluri adecvate.
SK	Upevnenie nábytku na stenu musí vykonať odborník, nakoľko sú pre montáž na stenu potrebné vhodné hmoždinky.

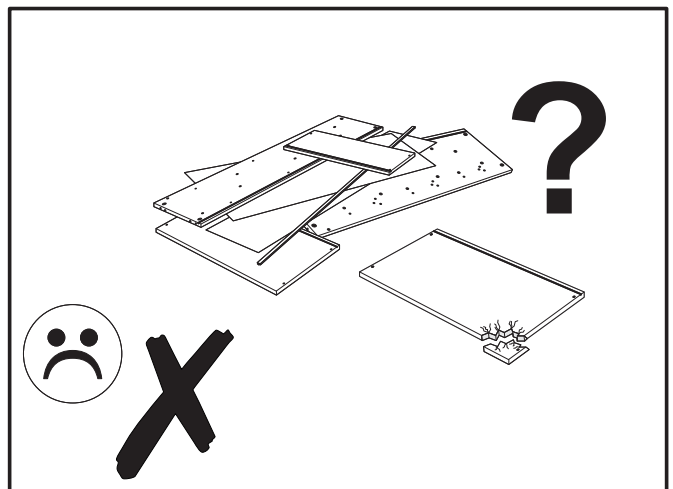
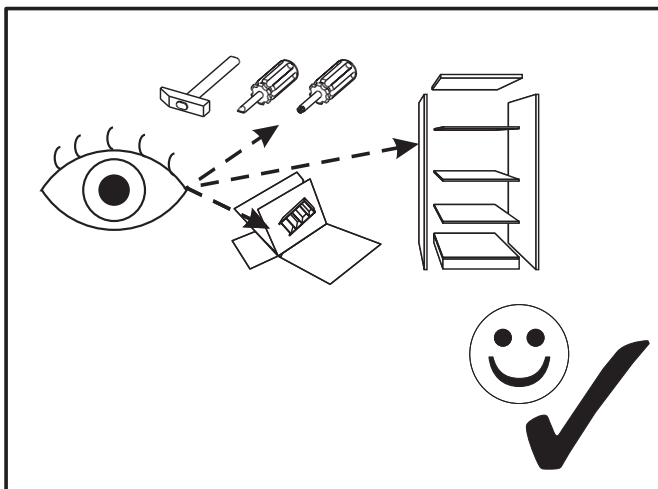
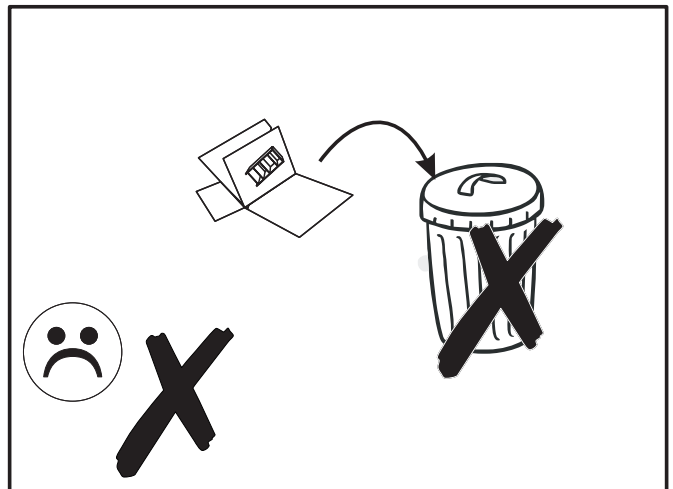
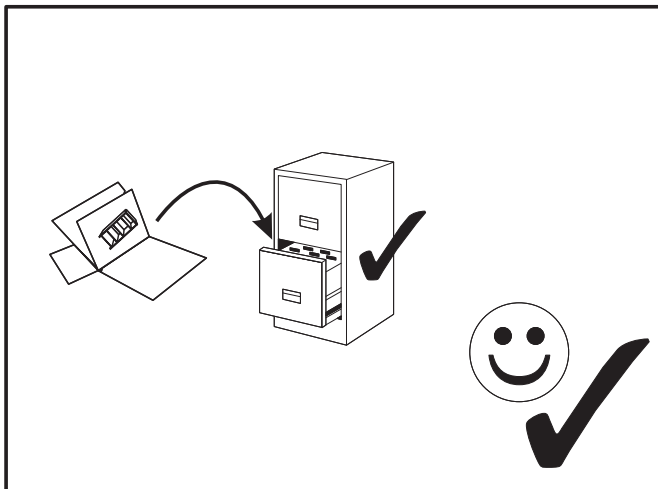
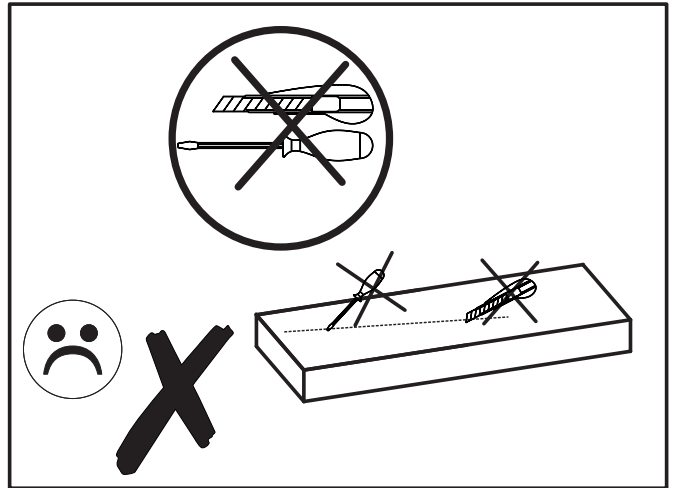
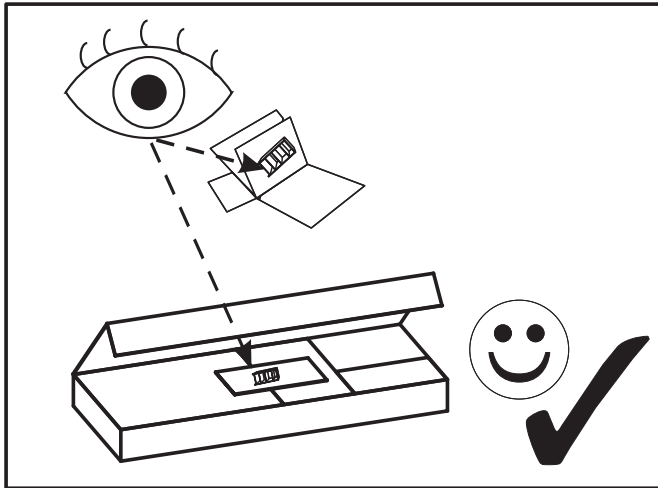



DETROIT 79

MM
260
250
240
230
220
210
200
190
180
170
160
150
140
130
120
110
100
90
80
70
60
50
40
30
20
10
0

NR 1

B1  $\phi 8 \times 28$ x22

M1  x6

T1  x6

K1  7x50 x6

C6  x6

J23  x6

P3  3x20 x8

L13  x4

W1  x8

C7  x4

NR 2

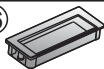
U276  x2

P13  3,5x13 x4

NR 3

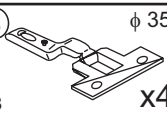
Z3  $\phi 35$ x4

Kr8

Y4  H2 x4

S3  3,5x13 x8

NR 4

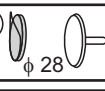
F15  $\phi 28$ x5

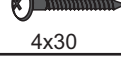
P6  4x30 x8

NR 5

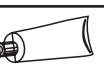
L1  x1

NR 6

11  x1

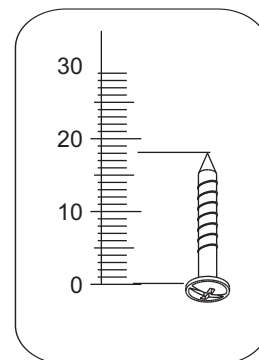

DETROIT 79

⑥ = 5kg

⑫ = 90kg

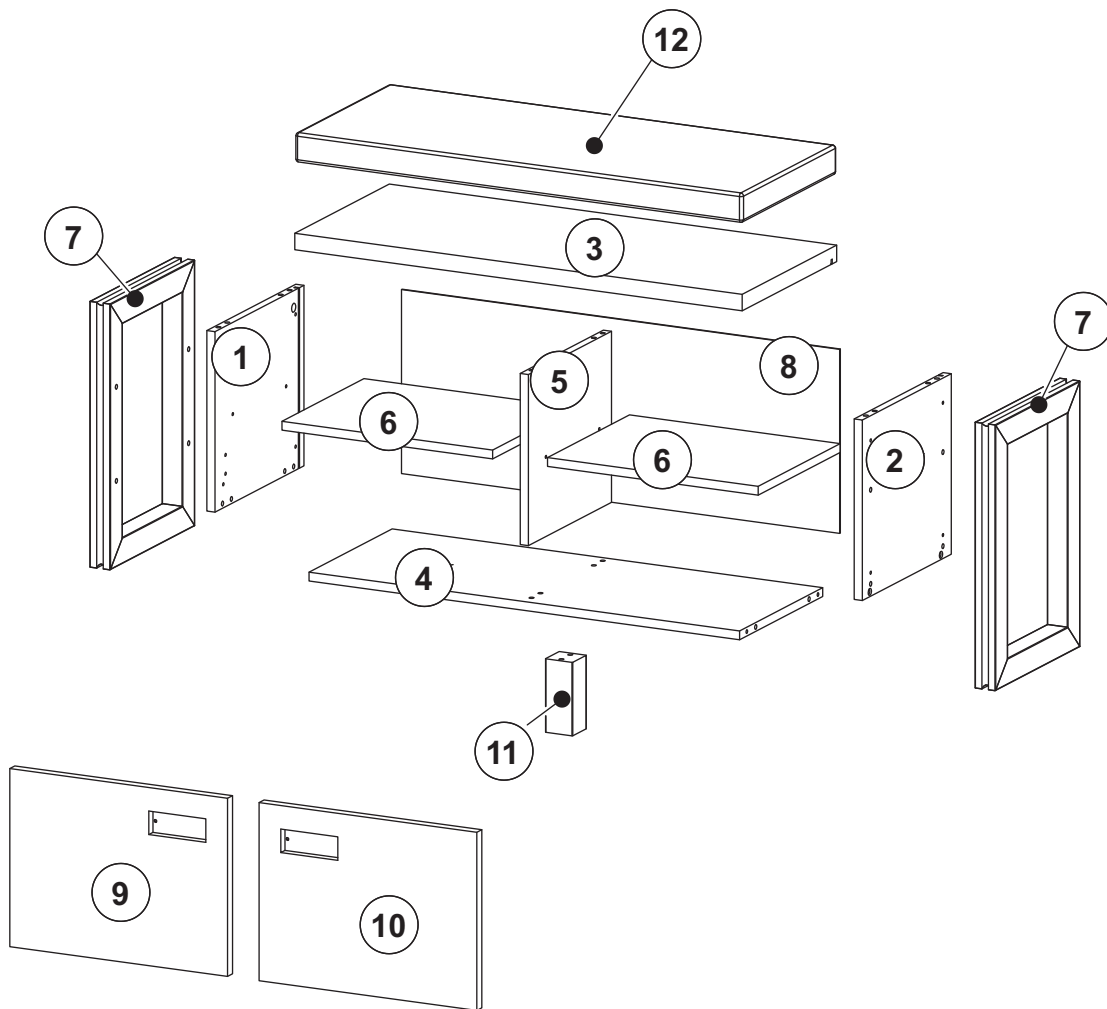

①	307	320	15	1	1/1
②	307	320	15	1	1/1
③	824	340	28	1	1/1
④	793	299	15	1	1/1
⑤	291	299	15	1	1/1
⑥	388	295	15	2	1/1
⑦	452	304	38	2	1/1
⑧	807	313	2,5	1	1/1
⑨	401	303	18	1	1/1
⑩	401	303	18	1	1/1
⑪	125	50	50	1	1/1
⑫	824	340	50	1	1/1

1

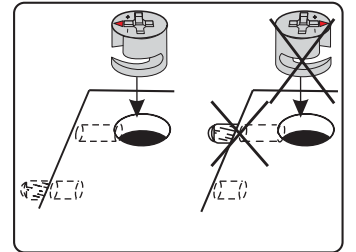
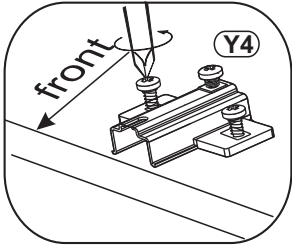
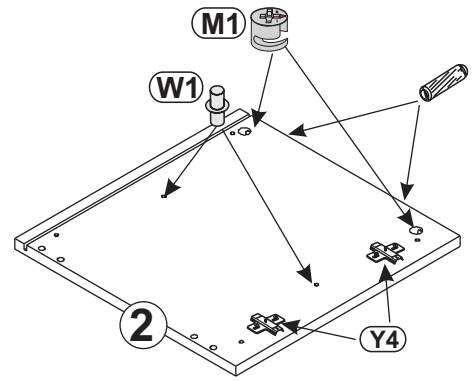
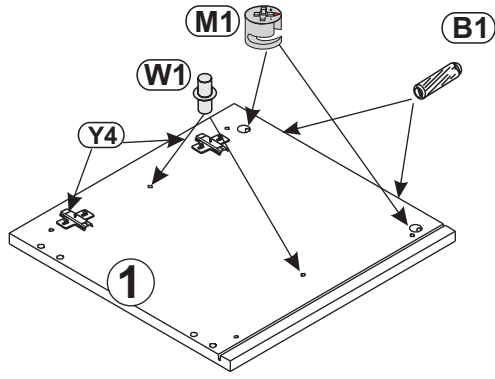
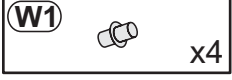
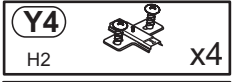
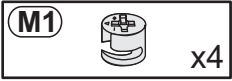
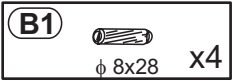

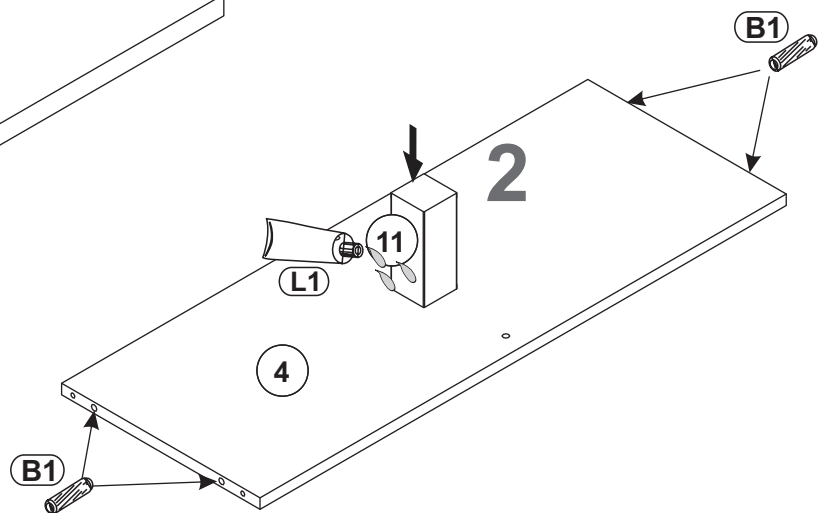
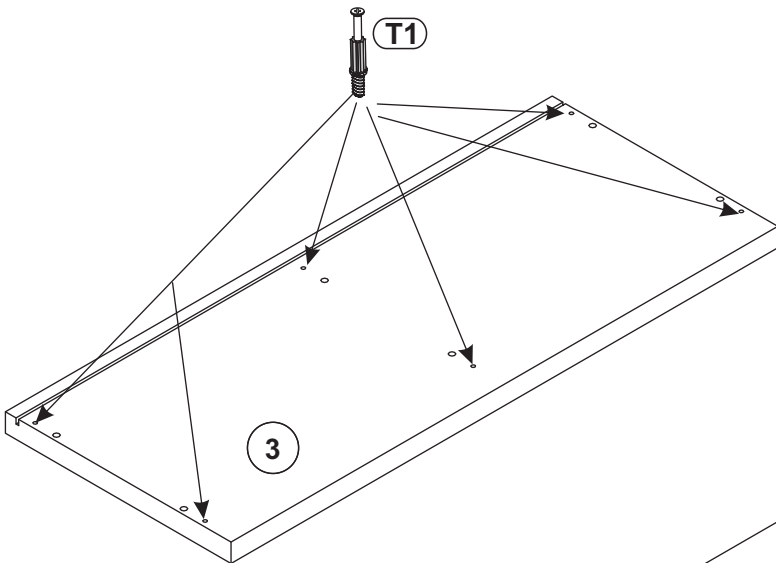
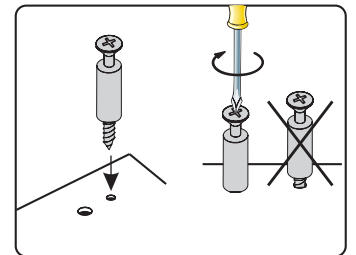
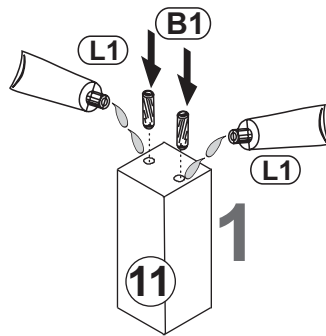
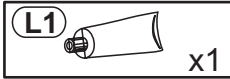
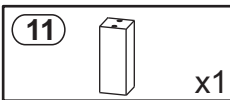
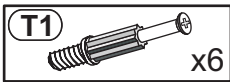

2



3

B1  $\phi 8 \times 28$ x4

M1  x2

W1  x4

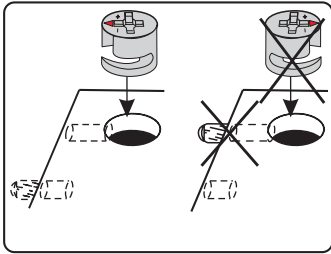
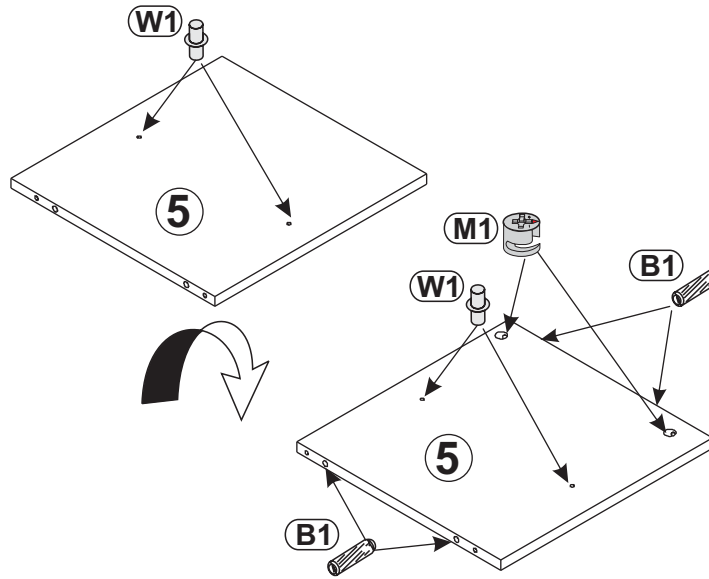

4

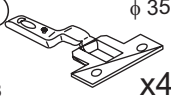
Z3  $\phi 35$
Kr8 x4

S3  3,5x13 x8

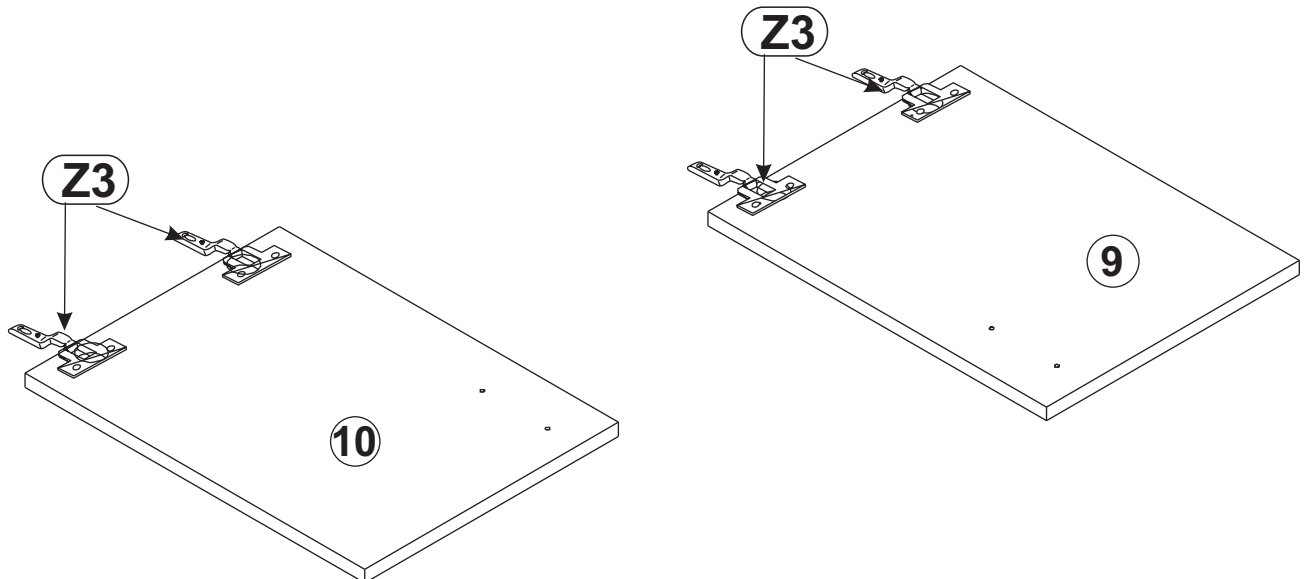
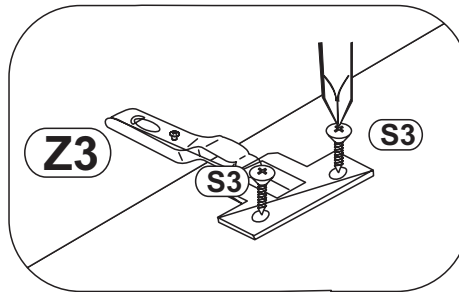

5

K1  7x50 x6

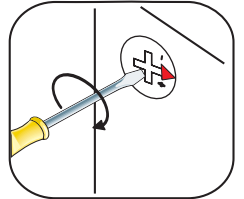
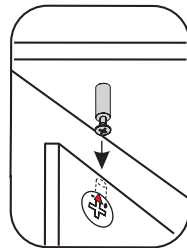
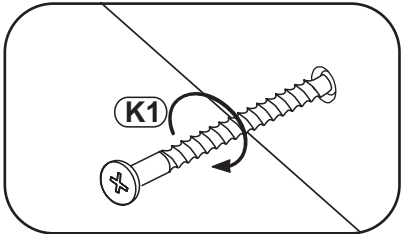
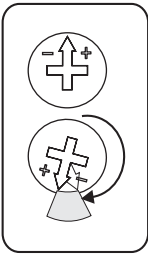
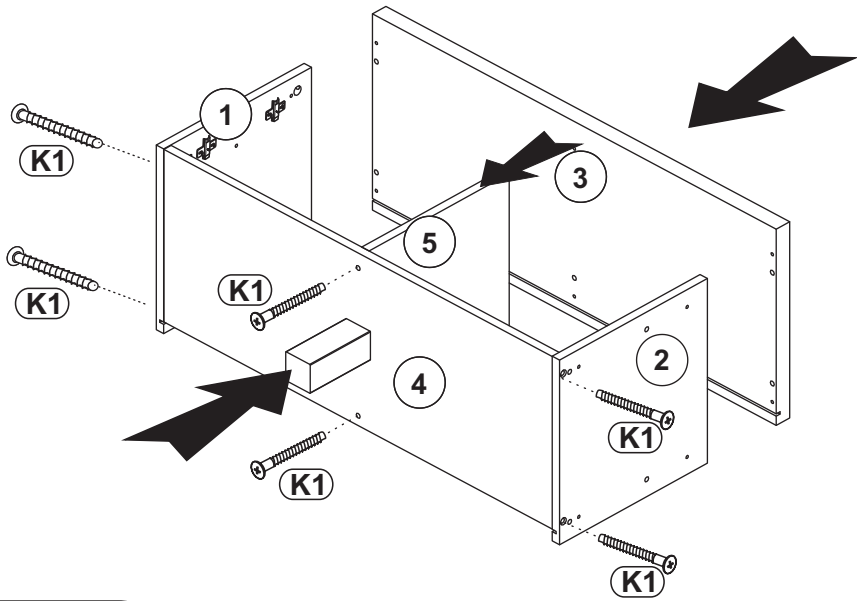

6

B1  ϕ 8x28 x8

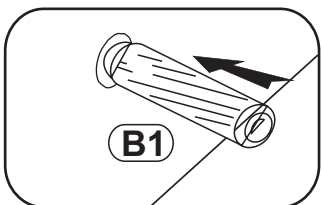
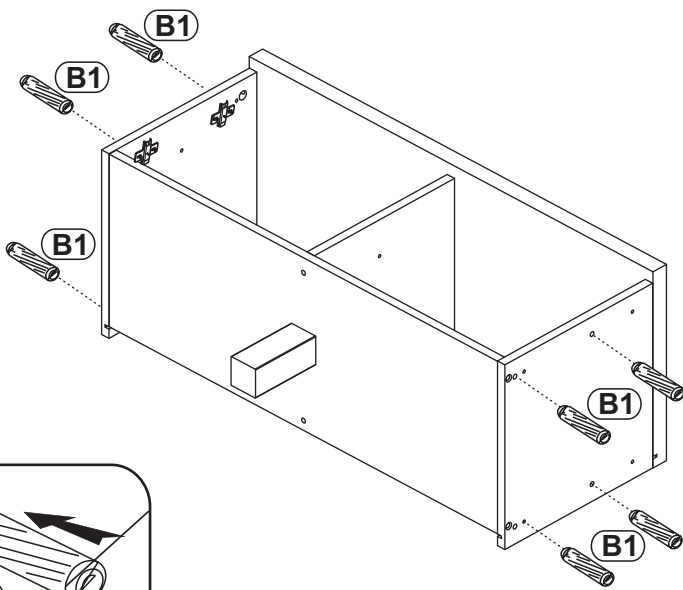

7

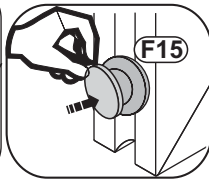
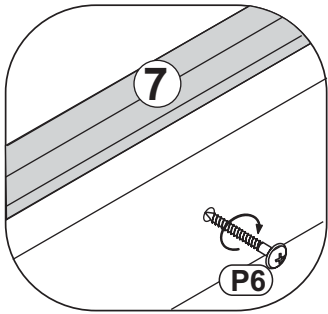
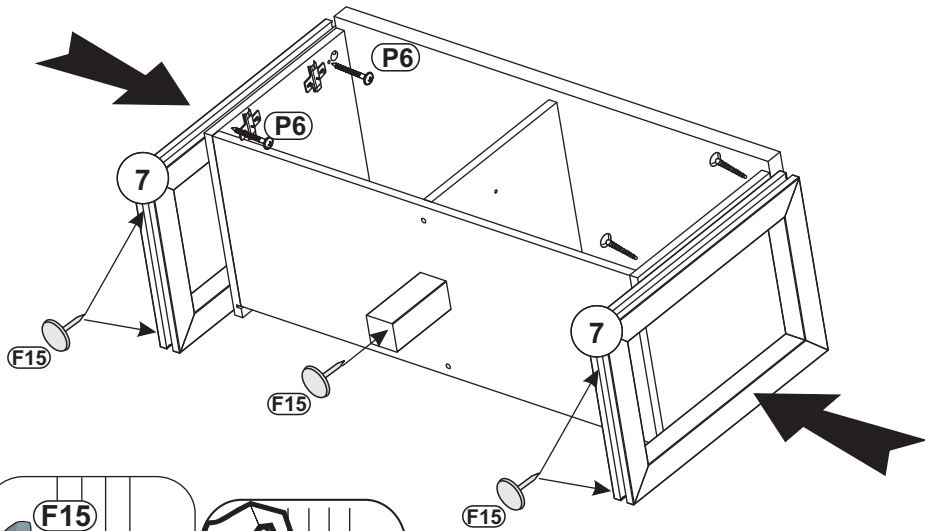
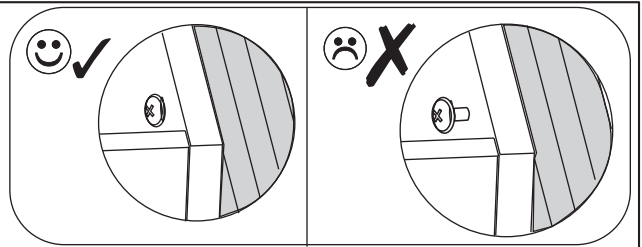
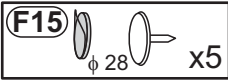
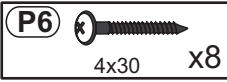

8

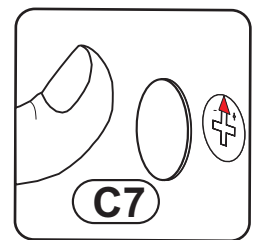
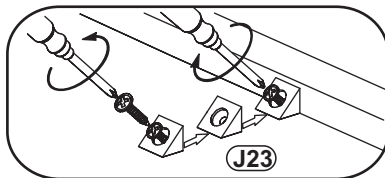
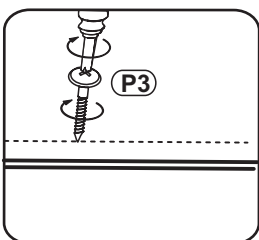
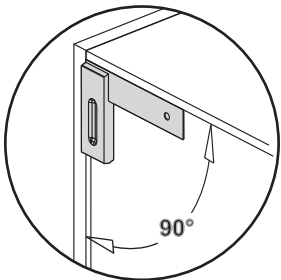
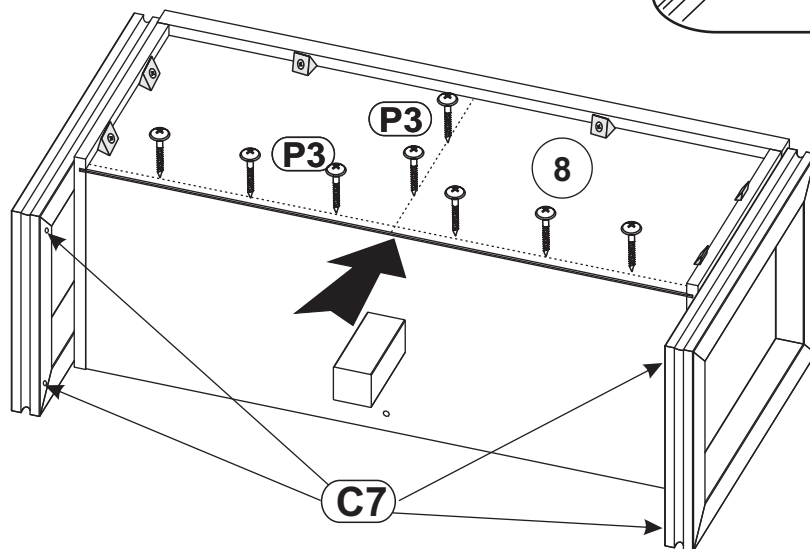
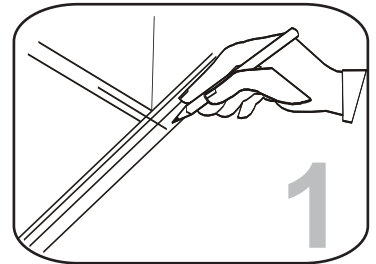
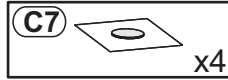
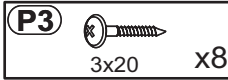

9

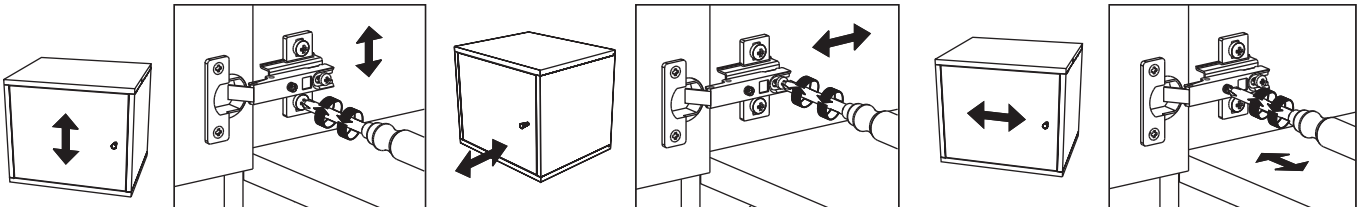
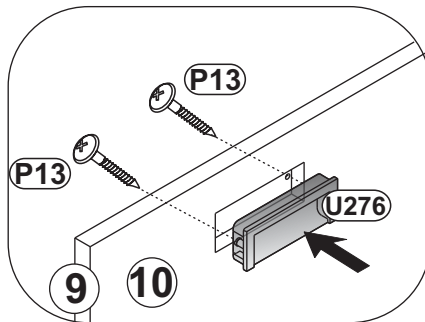
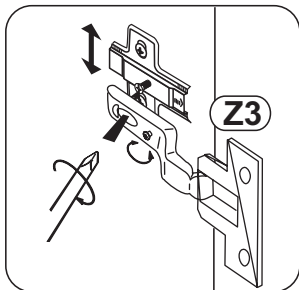
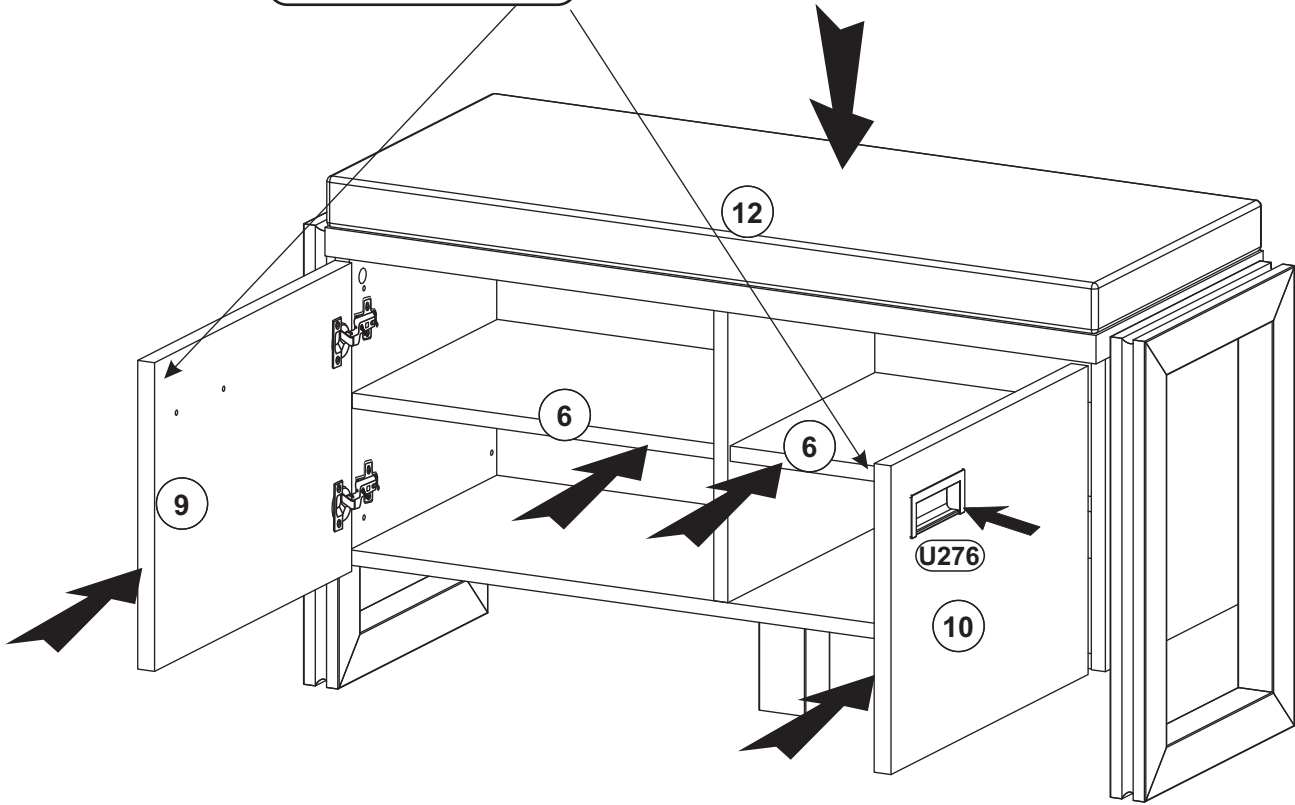
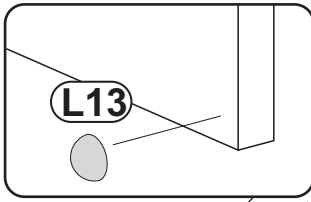
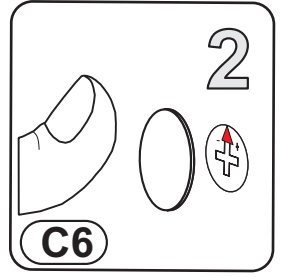
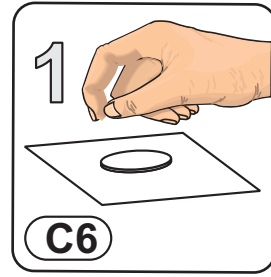
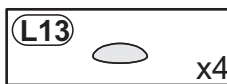
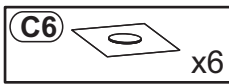
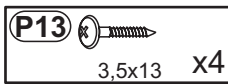
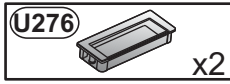

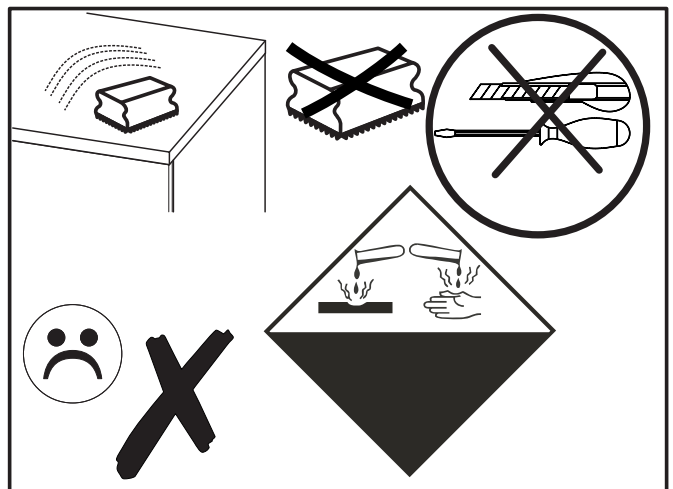
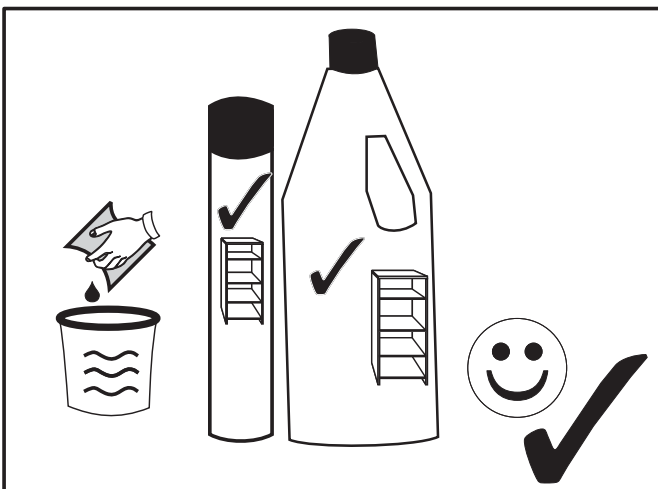
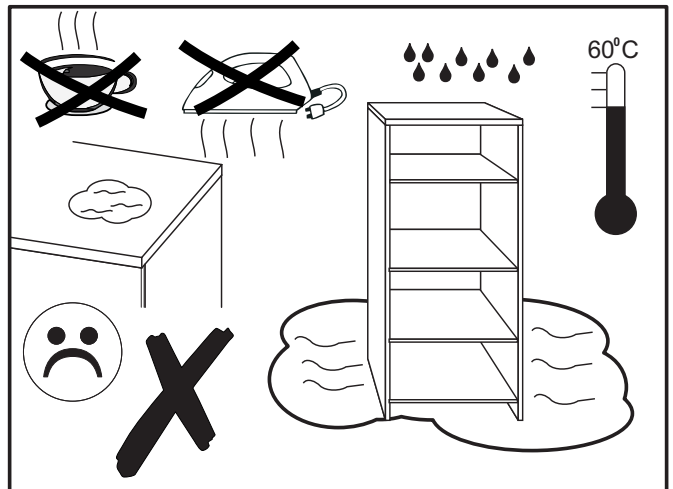
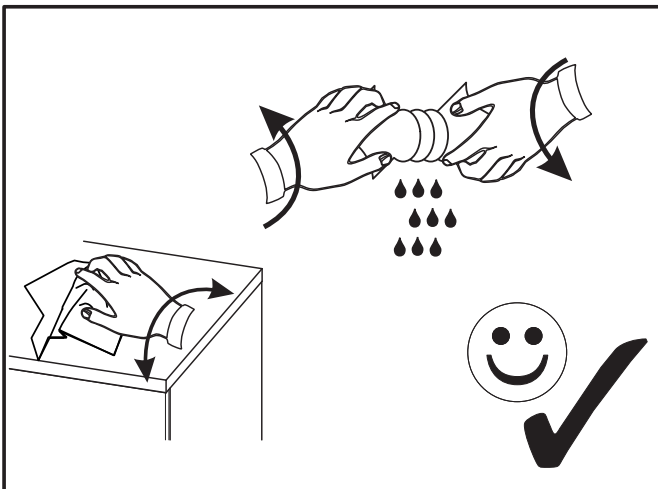
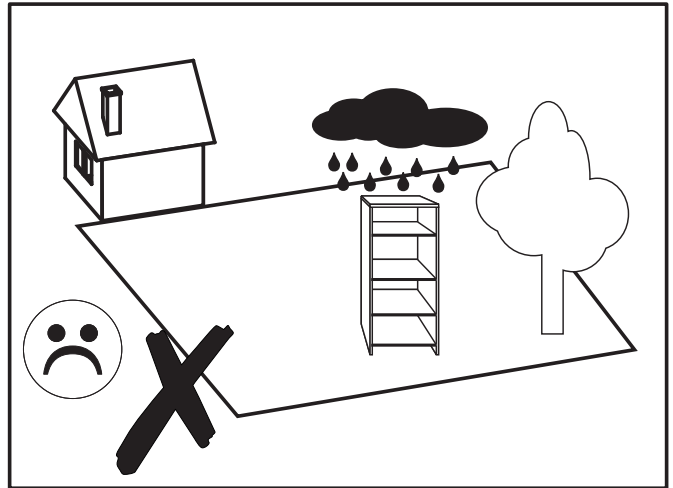
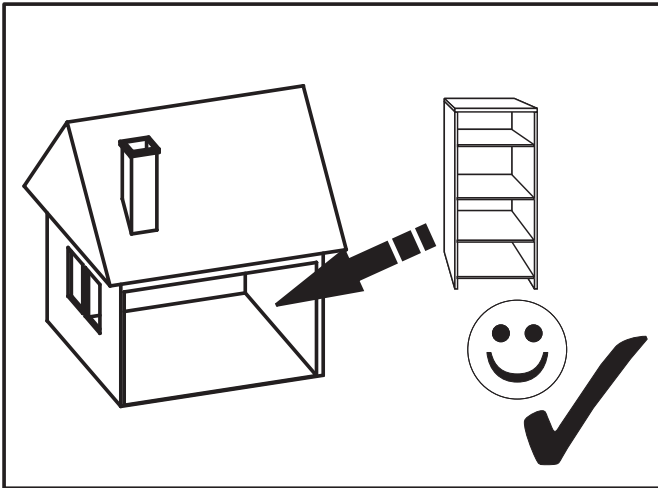



DETROIT 80

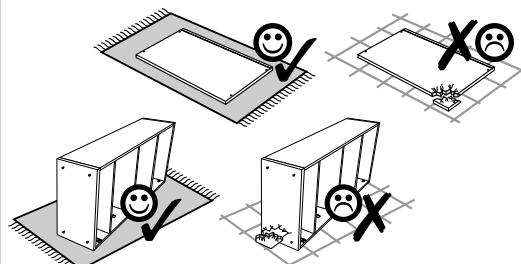
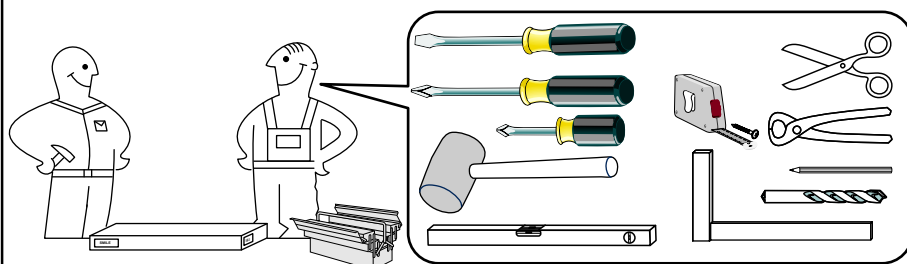
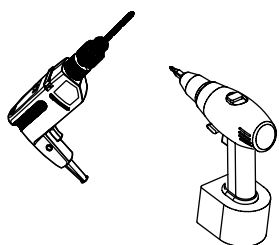
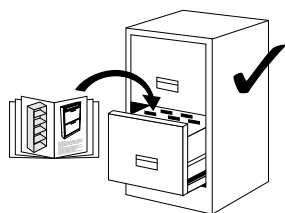
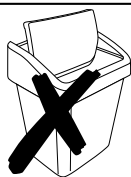
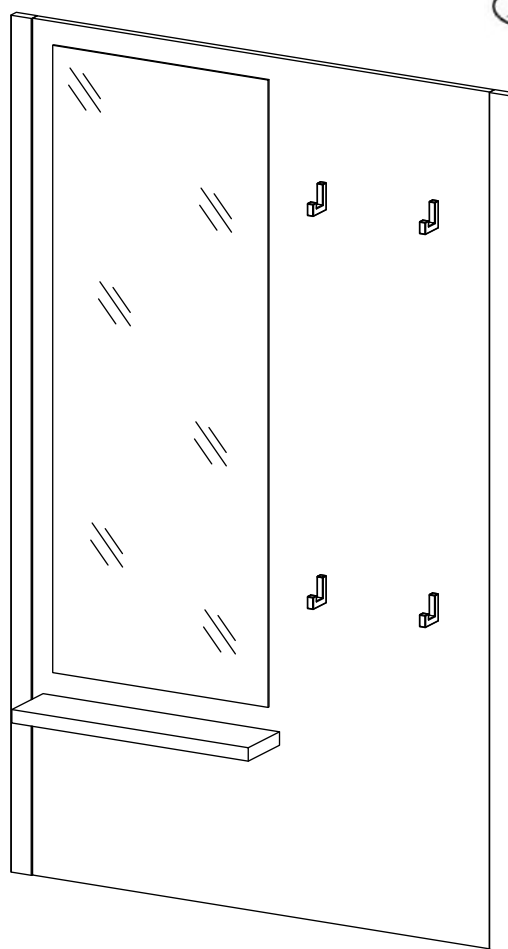
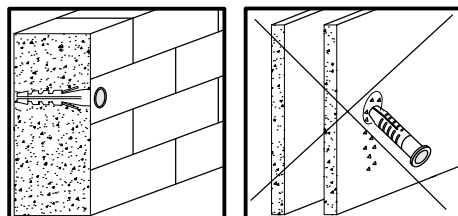
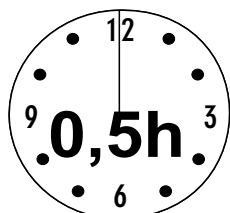

- (D) Montageanleitung
- (NL) Handleiding voor de montage
- (TR) Montaj talimatı
- (F) Instructions de montage
- (CZ) Montážní návod
- (HU) Összeszerelési útmutató
- (GB) Assembly instructions
- (PL) Instrukcja montażu
- (RU) Инструкция по монтажу
- (IT) Istruzioni di montaggio
- (SK) Montážny návod
- (RO) Instrucțiuni de asamblare

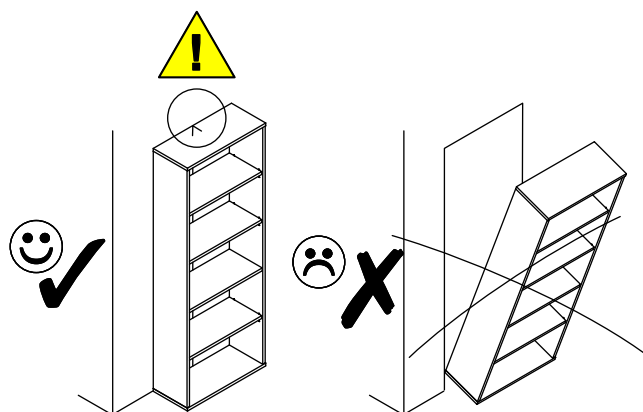



 Achtung • Opgelet • Uwaga • Dikkat • Внимание • Attention •Upozornění • Figyelem • Attenzione • Atenție 	
D	Überschreiten Sie angegebenen Maximalbelastungen nicht. Andernfalls kann das Möbelstück beschädigt oder zerstört werden.
GB	Do not exceed the maximum loads specified. Otherwise, the furniture may sustain damage or be irreparably damaged.
NL	Overschrijd de aangegeven maximale belastingen niet. Anders kan het meubelstuk worden beschadigd of vernield.
PL	Nie wolno przekraczać podanych maksymalnych wartości obciążenia. W przeciwnym razie mebel może zostać uszkodzony lub zniszczony.
TR	Belirtilen azami yük deđerini atmayınız, aksi taktirde mobilya parçası zarar görebilir veya kullanılamaz hale gelebilir.
RU	Не допускается превышение указанных максимальных нагрузок. В противном случае возможно повреждение или разрушение мебели.
FR	Ne dépassez pas les charges maximum indiquées. Sinon, le meuble peut être endommagé ou détruit.
CZ	Nepřekračujte uvedená maximální zatížení. V opačném případě může dojít k poškození nebo zničení nábytku.
HU	Tartsa be az engedélyezett maximális terhelhetőséget/teljesítményt. Különben a bútor és annak alkatrészei megsérülhetnek, tönk्रे mehetnek.
IT	Non superare il carico massimo indicato. Altrimenti il mobile rischia di rovinarsi o frantumarsi.
RO	Nu depășiți solicitările maxime specificate. Altfel puteți să deteriorați sau să distrugeți piesa de mobilier.
SK	Neprekročte uvedené maximálne zaťaženia. V opačnom prípade sa môže nábytok poškodiť alebo zničiť.
D	Die Befestigung des Möbelstückes an der Wand muss von einer fachkundigen Person vorgenommen werden, da für die Montage an die Wand angepasste Dübel erforderlich sind.
GB	A qualified professional is required when mounting furniture to the wall since dowels corresponding to the wall are required for this.
NL	Een vakkundige persoon dient het meubelstuk aan de muur te bevestigen; voor de montage aan de muur zijn immers aangepaste pluggen vereist.
PL	Mocowanie mebla do ściany mogą przeprowadzić wyłącznie wykwalifikowane osoby, z uwagi na zastosowanie odpowiednio dopasowanych kołków do rodzaju ściany.
TR	Mobilya parçasının duvara sabitlenmesi, duvar montajı için özel uyarlanmış dübeller gerektirdiğinden bu iş sadece bu konuda uzman bir kişi tarafından gerçekleştirilmelidir.
RU	Поскольку для монтажа на стене необходимо использовать специальные дюбели, мебель должна быть закреплена на стене квалифицированным персоналом.
FR	La fixation du meuble contre le mur doit être effectuée par une personne compétente car, pour le montage mural, il faut utiliser des chevilles adaptées.
CZ	Montáž nábytku na stěnu musí provést odborník, protože k montáži na stěnu jsou zapotřebí upravené hmoždinky.
HU	A bútorlemek falra rögzítését szakembernek kell végeznie, mert a rögzítéshez megfelelő tiplit kell használni.
IT	Il fissaggio del mobile alla parete deve essere eseguito da persone esperte, dato che occorrono tasselli adeguati.
RO	Fixarea la perete a piesei de mobilier se realizează numai de către personal competent, deoarece montajul de perete necesită dibluri adecvate.
SK	Upevnenie nábytku na stenu musí vykonať odborník, nakoľko sú pre montáž na stenu potrebné vhodné hmoždinky.

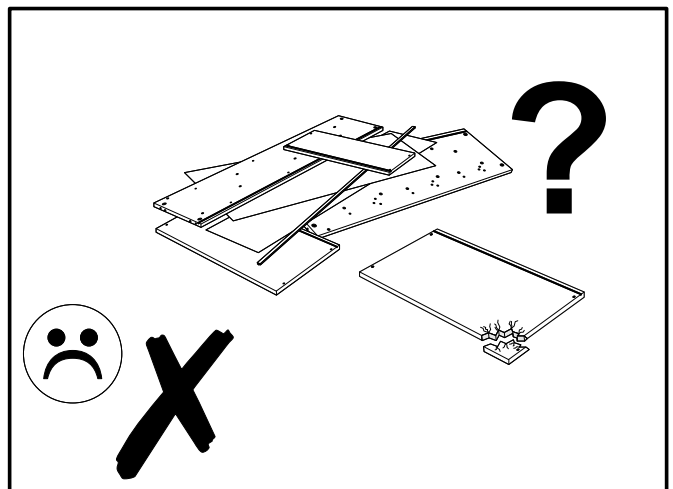
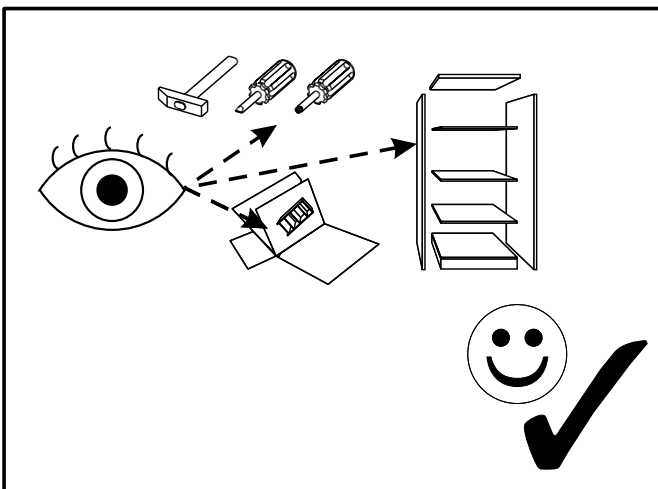
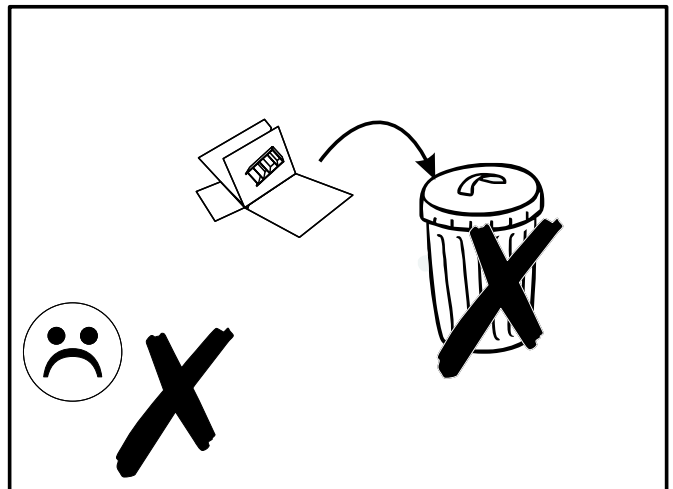
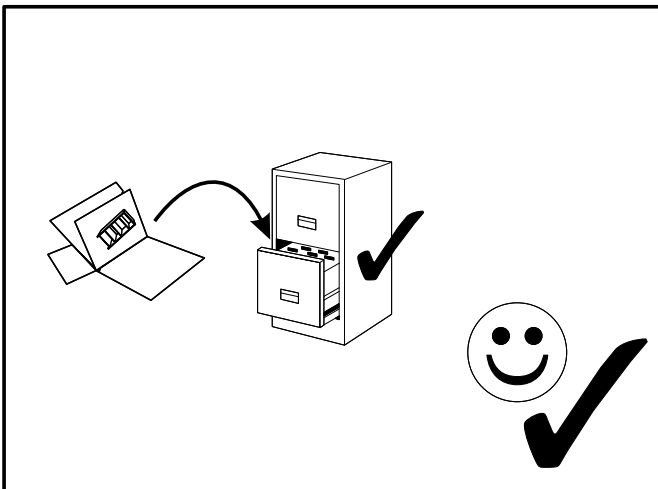
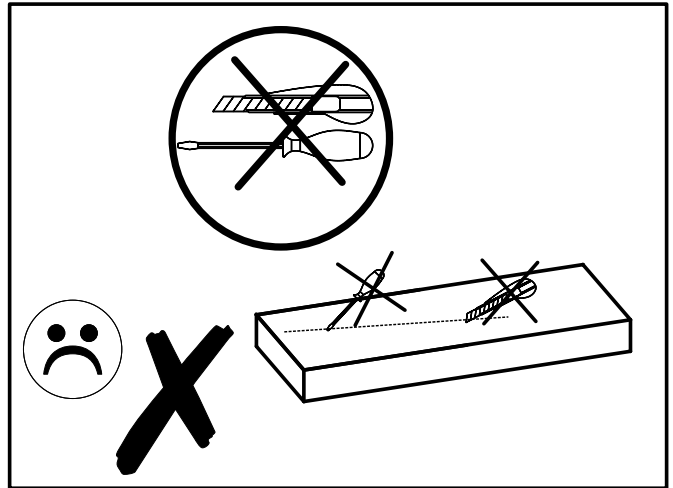
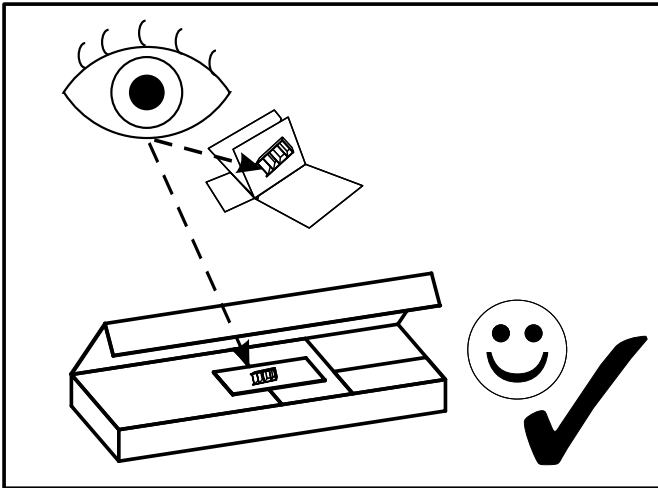
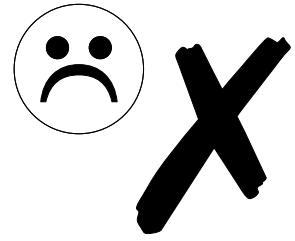

1

M1  x8

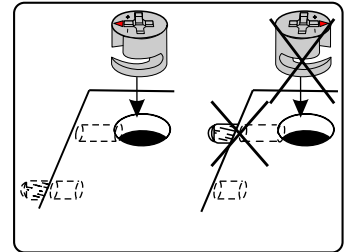
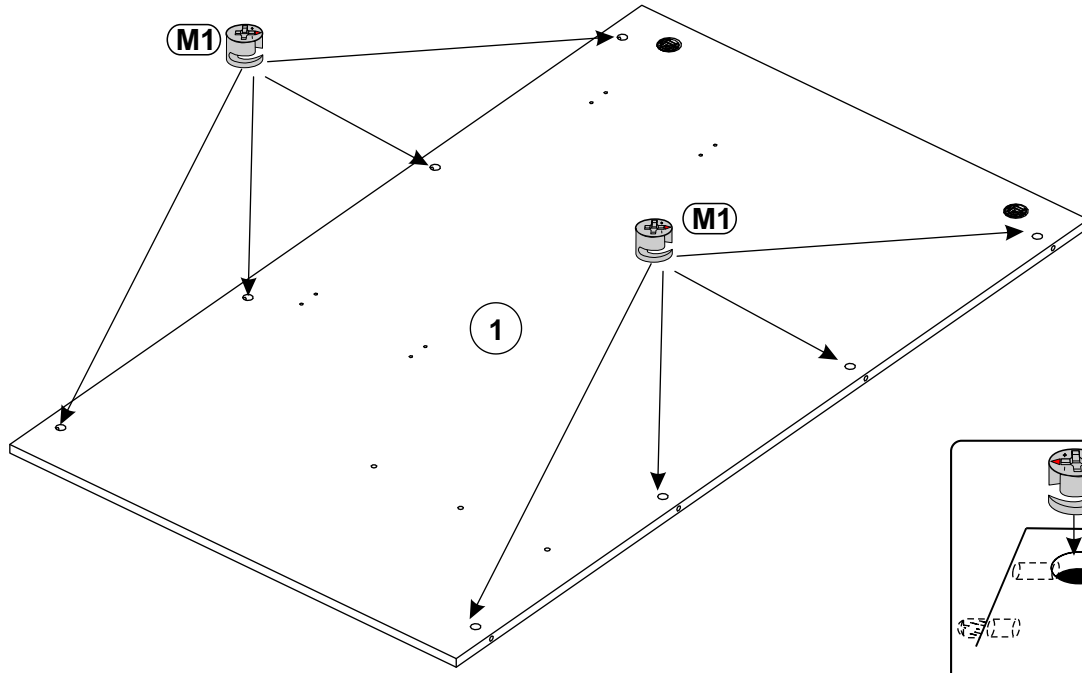

2

T1  x8

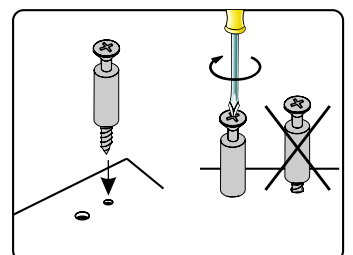
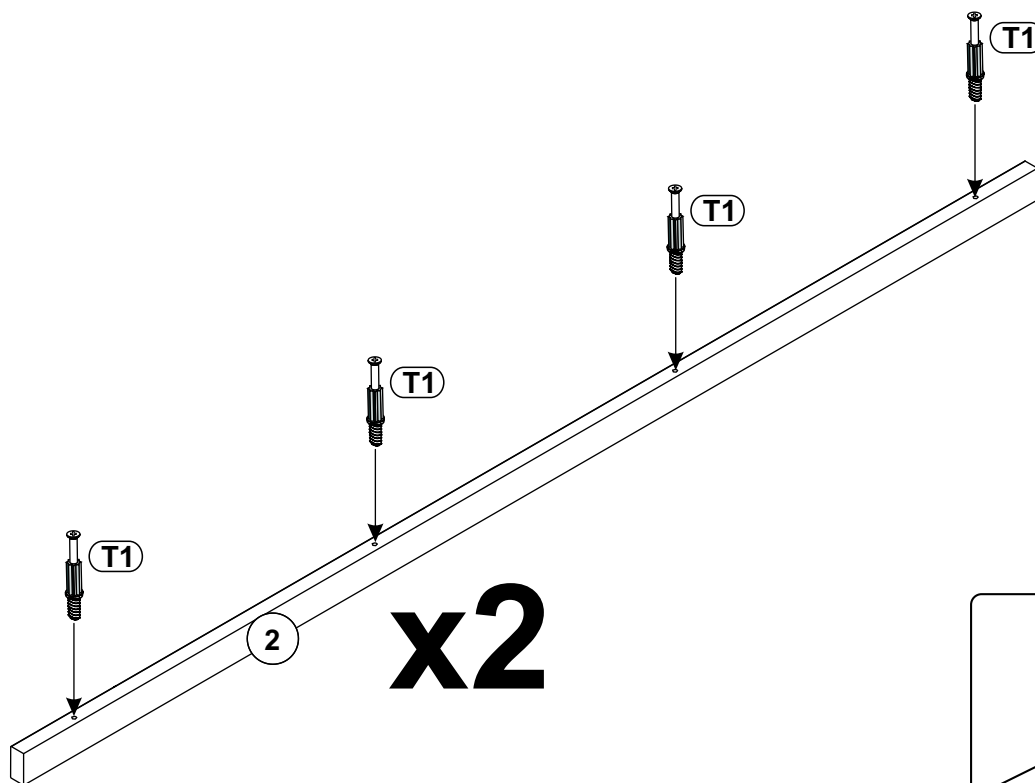

3

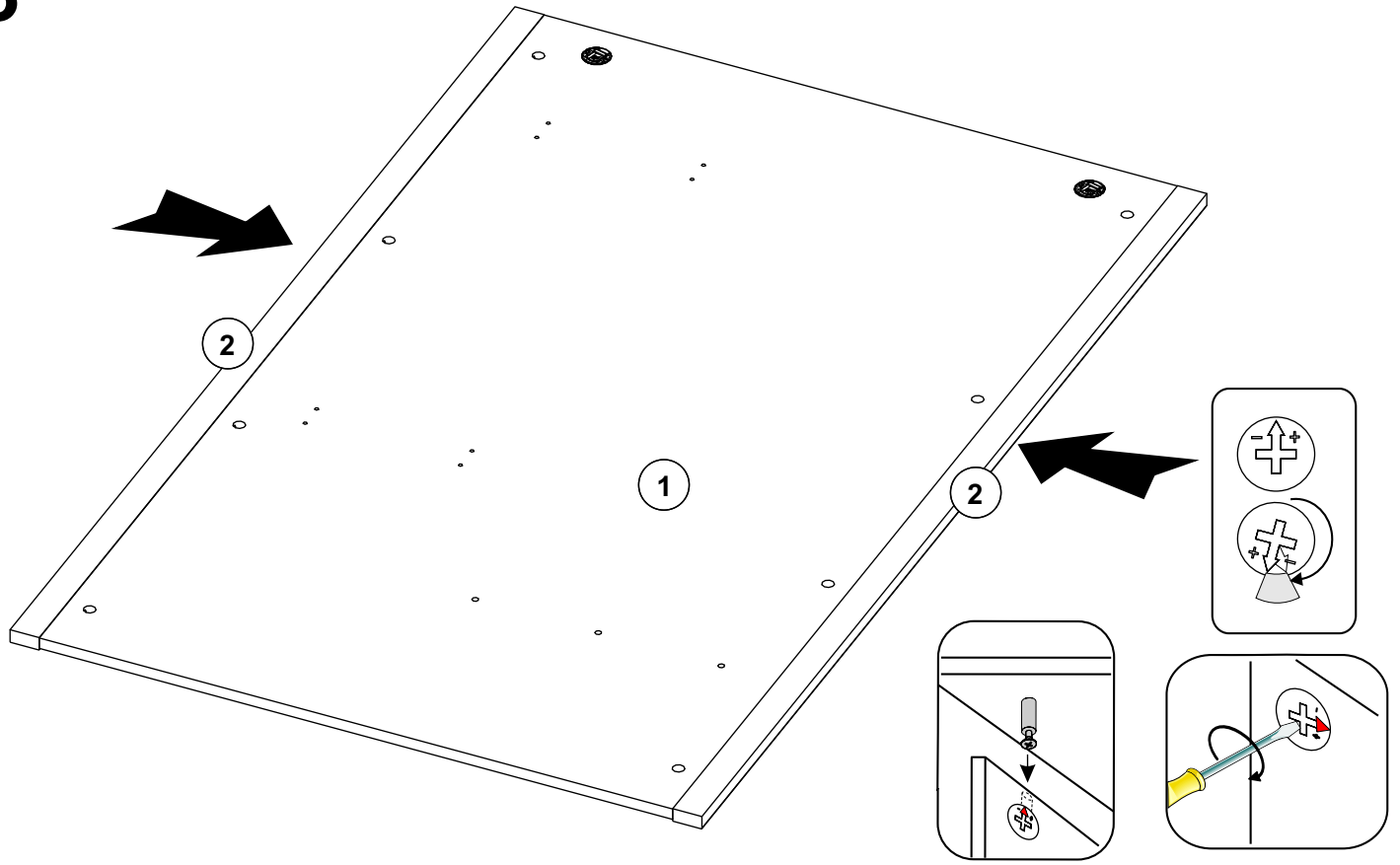

4

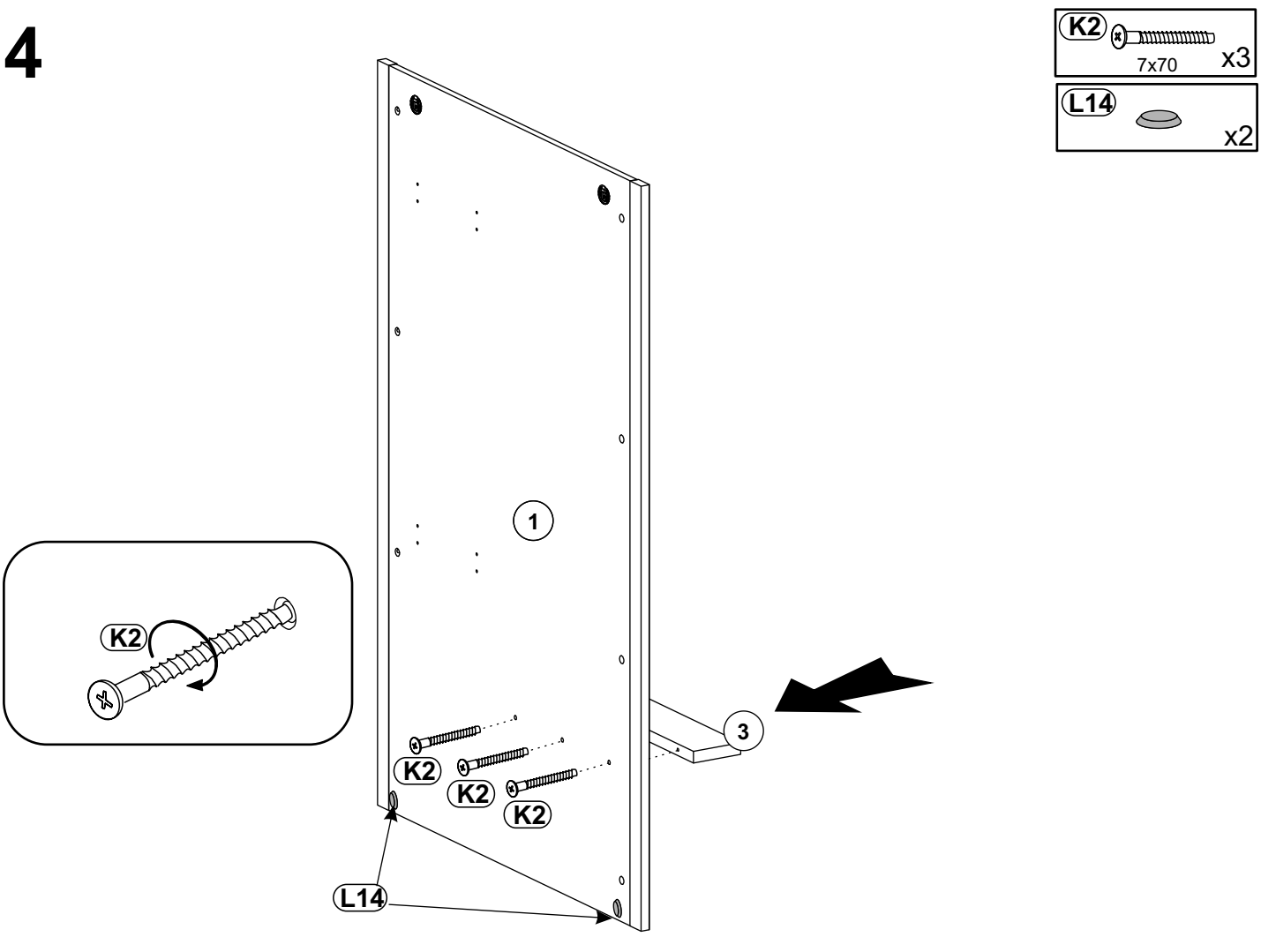

5

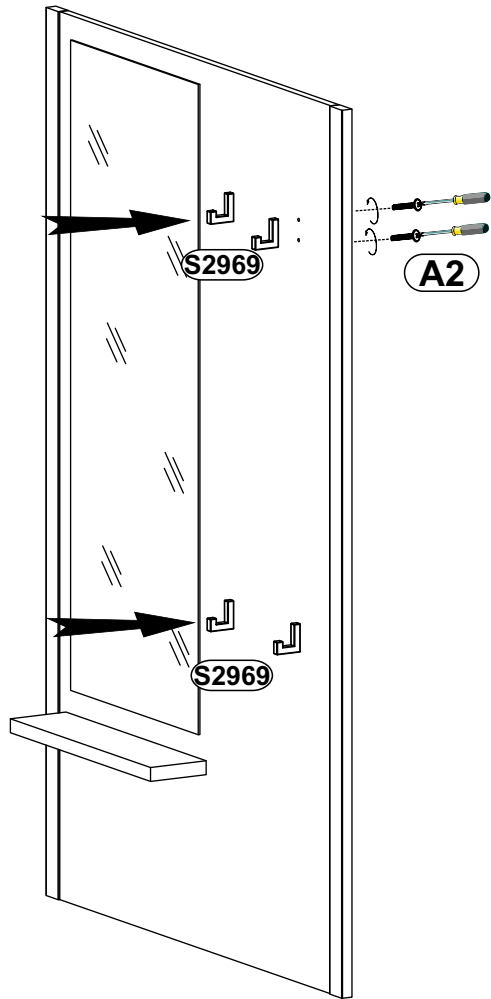

S2969 x4

A2 M4x22 x8

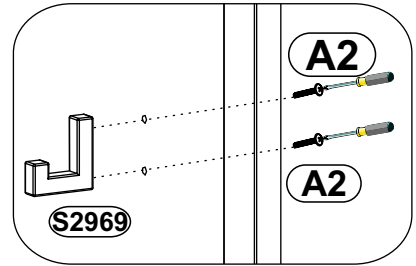

6

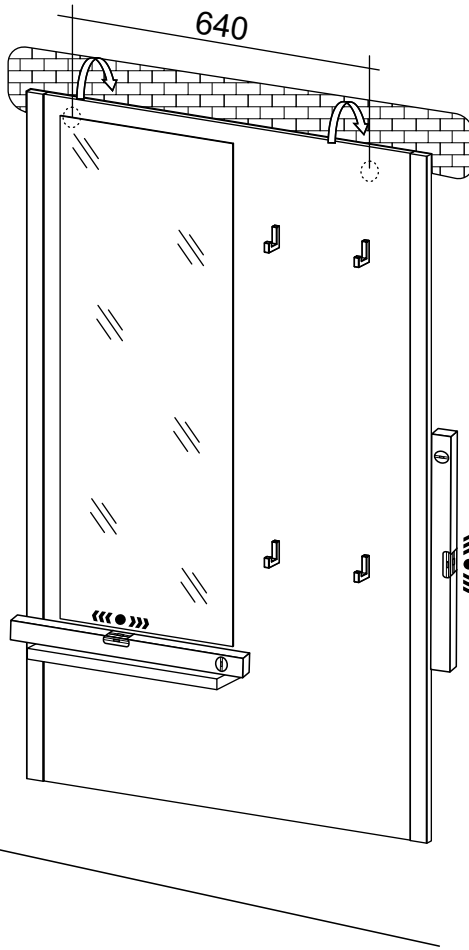
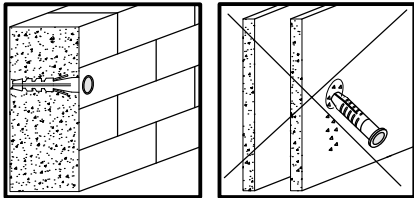

H57 x2

