



# EKIPA

0094NOTIC5830



## Buffet de cuisine

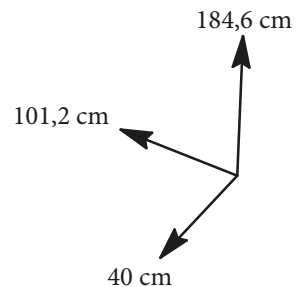
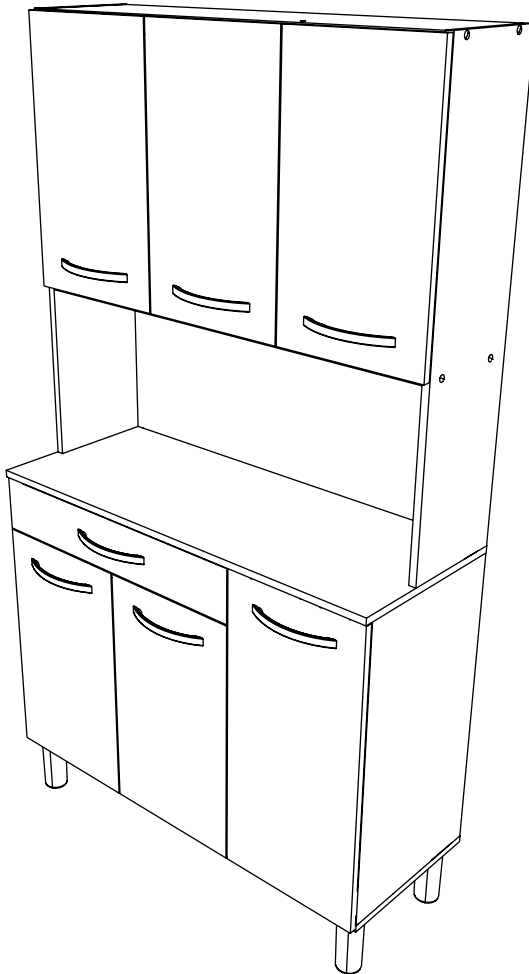

**FR Remerciements :**  
Nous vous remercions d'avoir choisi un meuble créé et fabriqué par Ekipa et espérons qu'il vous donnera entière satisfaction.

**EN Thanks :**  
Thank you for choosing furniture designed and manufactured by Ekipa. We hope you are totally satisfied your purchase.

**ES Agradecimientos :**  
Les damos las gracias por haber elegido un mueble diseñado y fabricado por el Ekipa y esperamos que sea de su total agrado.

**DE Danksagung:**  
Wir danken Ihnen für den Kauf eines Frankreich von der Ekipa entworfenen und hergestellten Möbelstücks und hoffen, dass Sie es zu Ihrer vollkommenen Zufriedenheit finden werden.



Temps de montage : 3h



contact@parisot.com



### Conseils de préparation au montage : 15 min

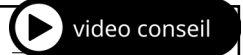

<https://qrco.de/bcJeNz>

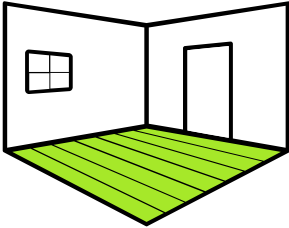

Faire un peu de place

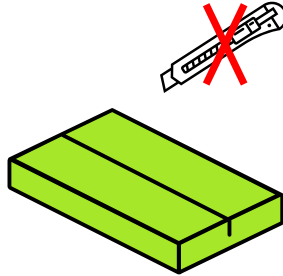

Pas d'outils tranchants

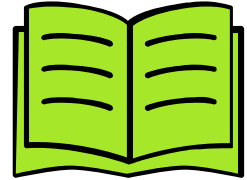

Bien suivre les instructions de la notice de montage

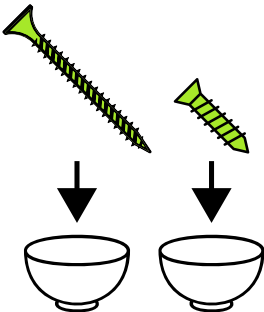

Trier vos quincailleries

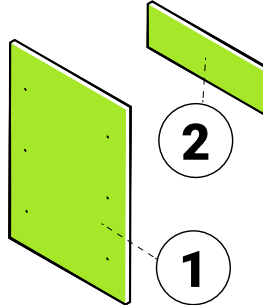

Repérer vos pièces

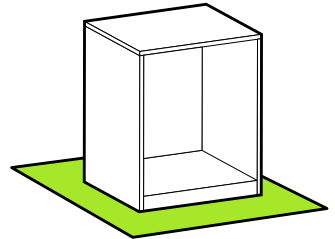

Protéger votre sol

### Matériel nécessaire

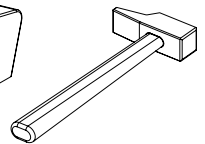
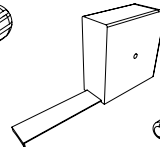
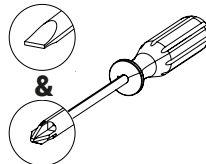
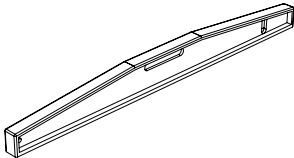

### Conseils d'entretien

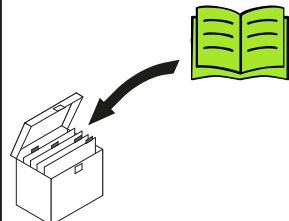



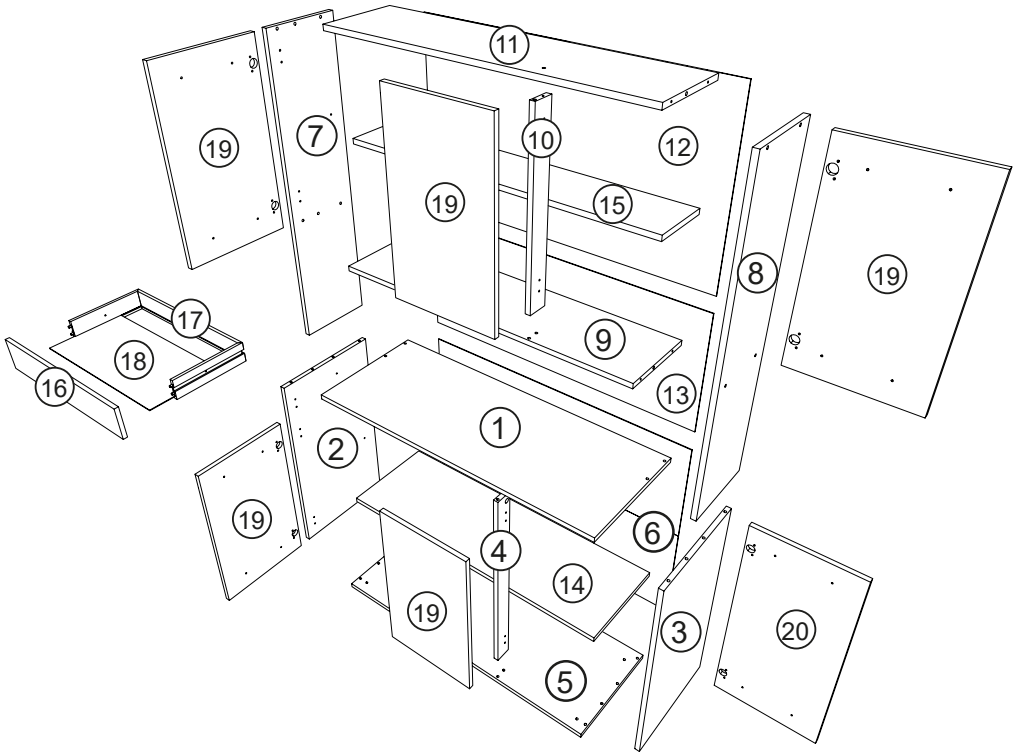





















Repérer vos pièces











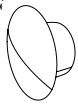

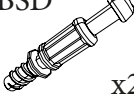

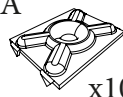



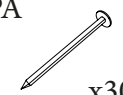

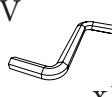
Rep	Qté	cm			Rep	Qté	cm		
01	1	101,2	40	1,6	11	1	97,9	25,5	1,6
02	1	69,6	38	1,6	12	1	100,4	57,6	0,25
03	1	69,6	38	1,6	13	1	100,4	40,8	0,25
04	1	69,6	5,5	1,6	14	1	97,8	32,3	1,6
05	1	101,2	38	1,6	15	1	97,8	15	1,6
06	1	100,4	72	0,25	16	1	67,1	12,5	1,6
07	1	97,8	24,6	1,6	17	1	123,3	8	1,25
08	1	97,8	24,6	1,6	18	1	61,9	29,9	0,25
09	1	97,9	24,5	1,6	19	5	57,4	33,4	1,6
10	1	55,3	6,4	1,6	20	1	70,2	33,4	1,6

# Trier vos quincailleries

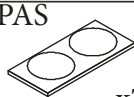
0 1cm 2 3 4 5

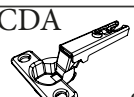
		VR	x4
		VMF1	x1
		VG	x1
		CDS	x48
		VAF8	x4
		FO	x1
		BWF	x4
		WJ	x10
		VO1	x4
		ADM	x24
		HW	x16
		AB	x2

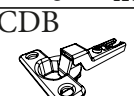
ZF		CC08	
AI		BSD	
CA		FA	
BWD		JB	
Pied		PA	
ZK		HV	
CF		OO	
PB		PAS	
CP			
CDD		CDA	
EC		CDB	

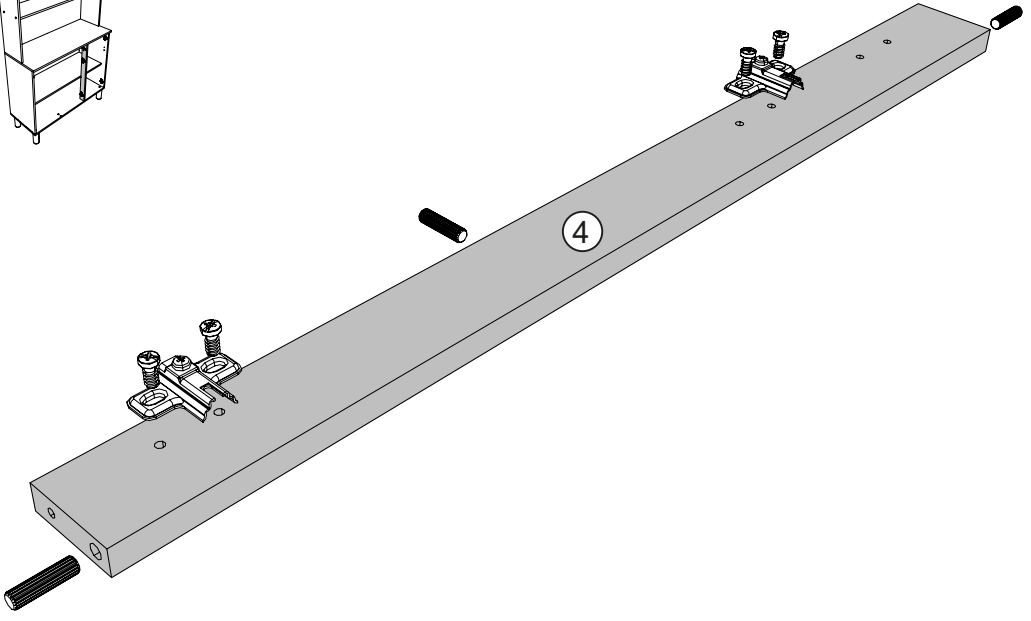
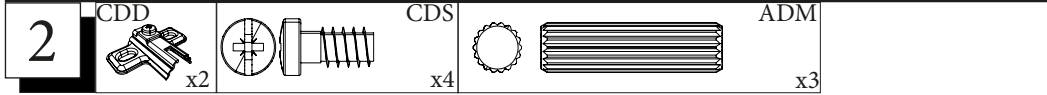
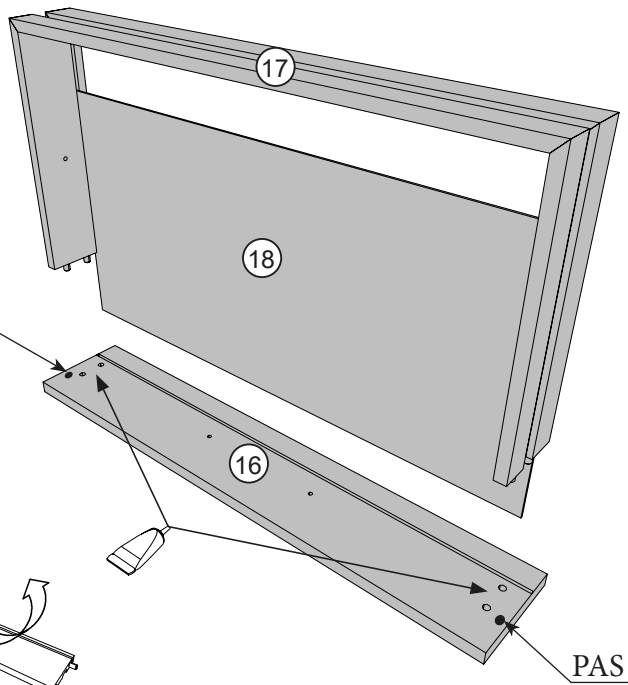
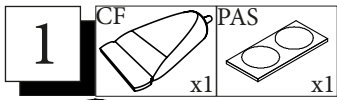

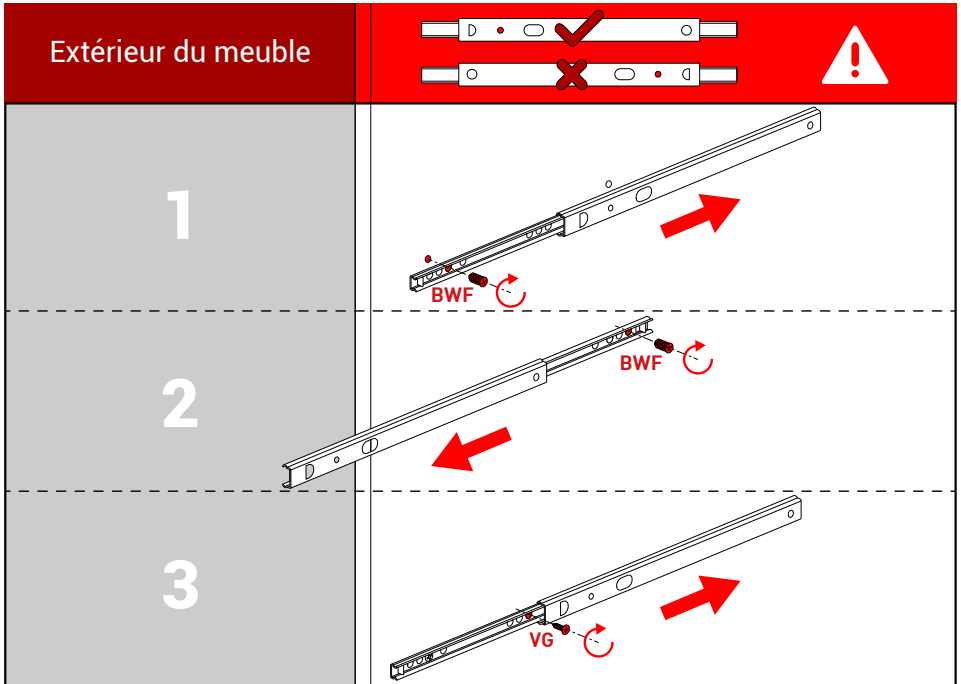
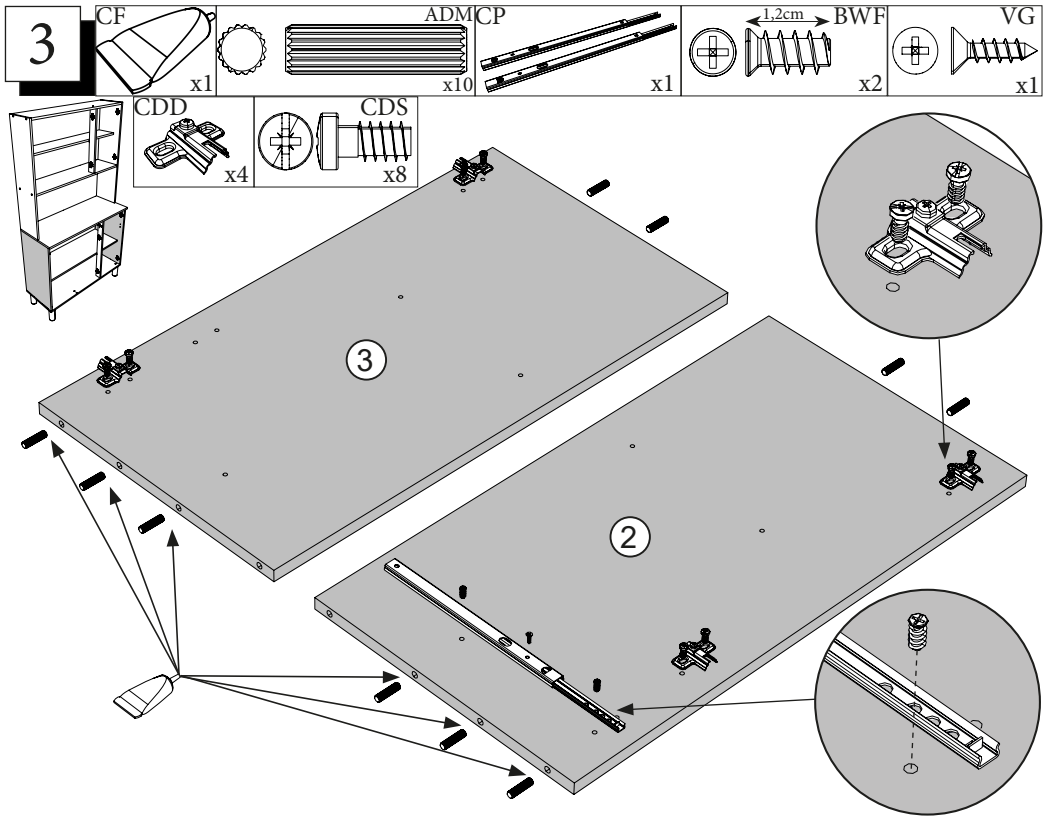

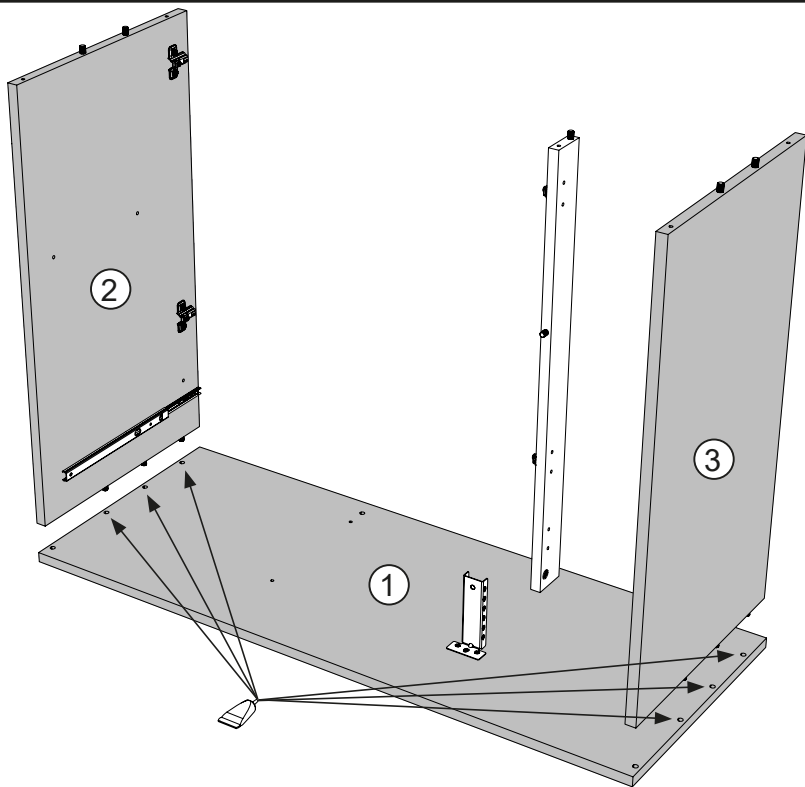
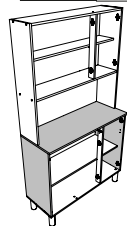
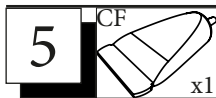
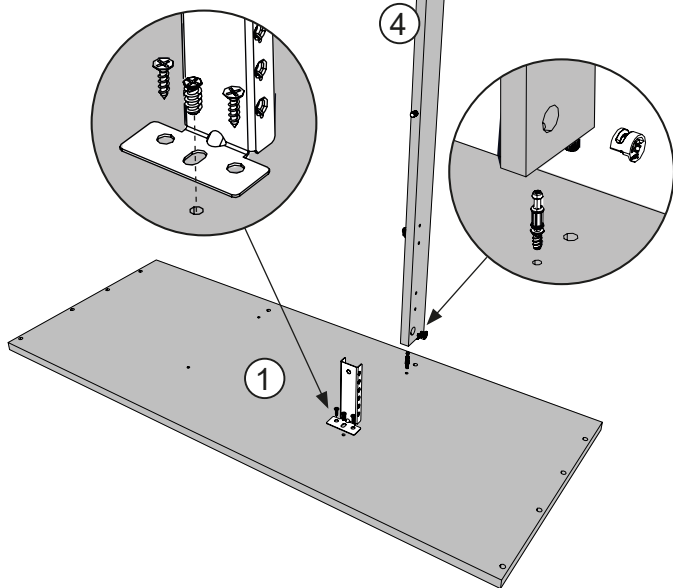
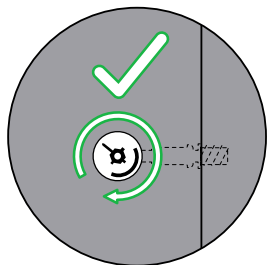
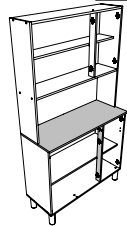
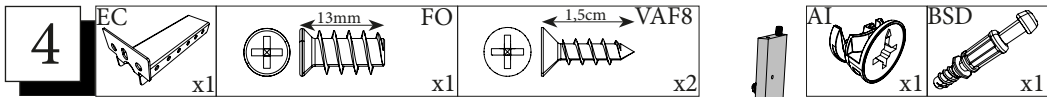

6

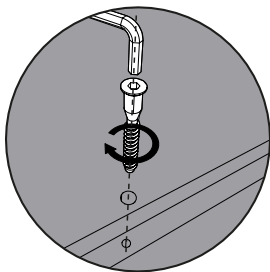
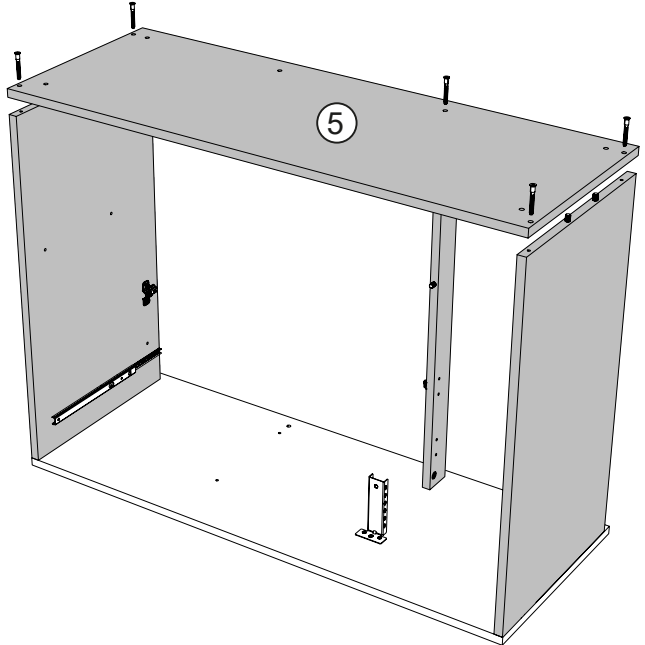
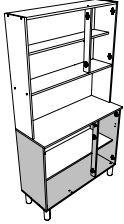
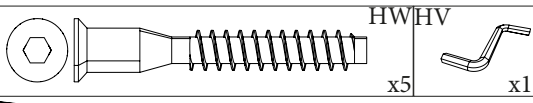

7

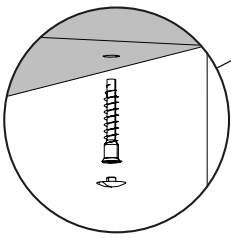
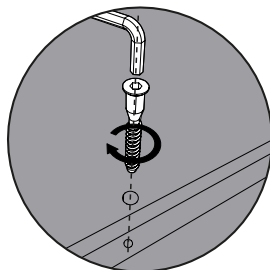
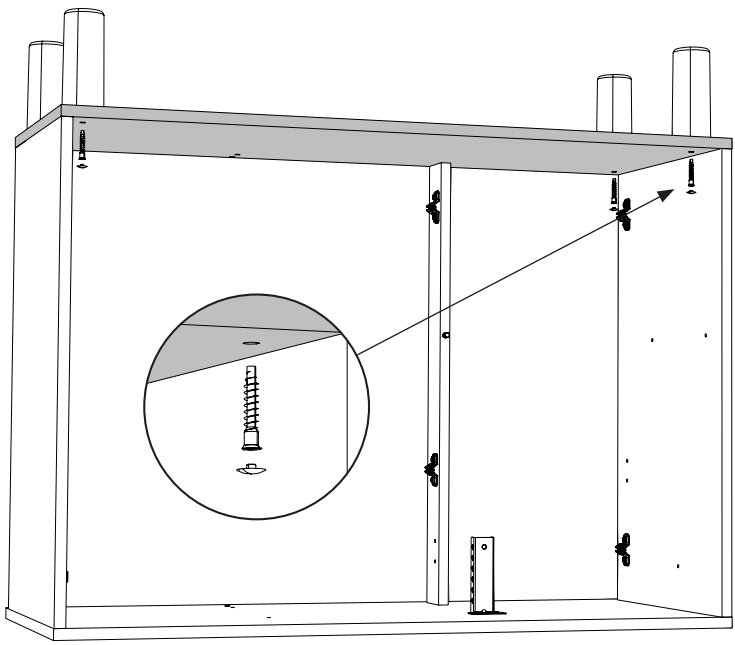
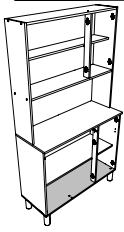
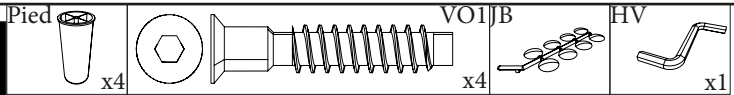



8

PA



x14

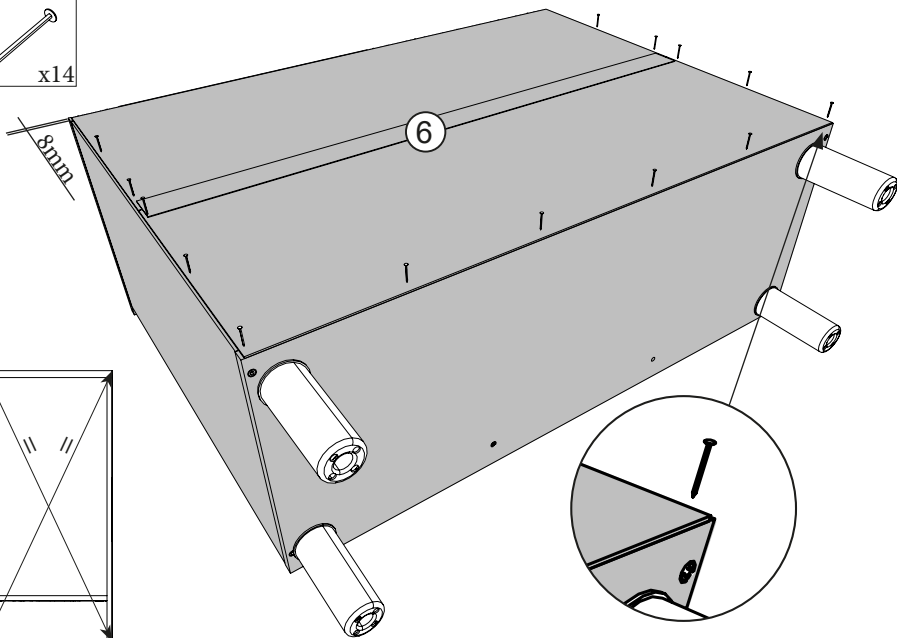

FR- Mesurer les diagonales du meuble pour vérifier l'équerrage. La mesure doit être identique.

EN- Measure the diagonals of the piece of furniture to check for straightening. The measurement must be identical.

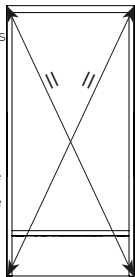

9

CP



x1

CA



x1

CC08



x1

VMF1

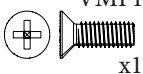

x1

VR

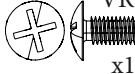

x1

BWF

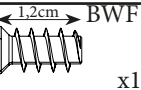

x1

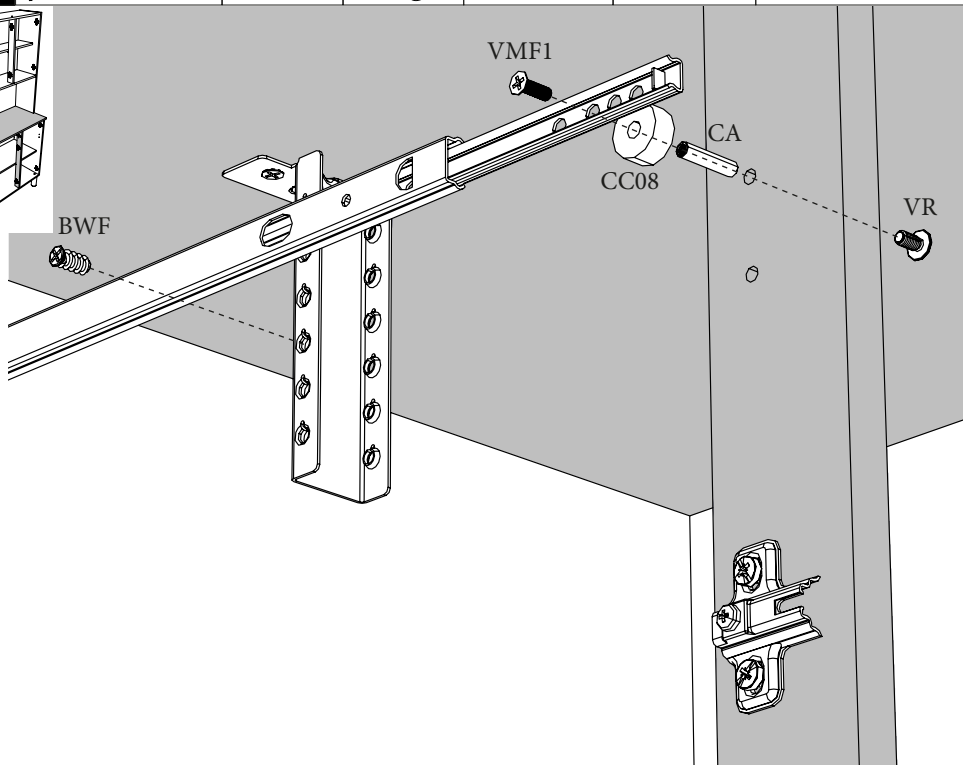
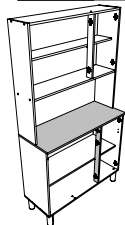

10

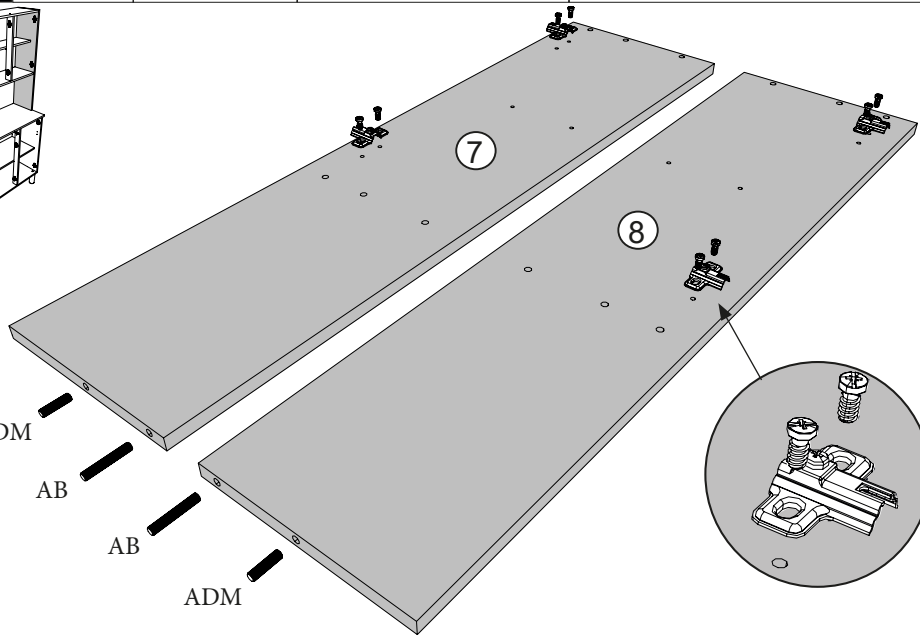
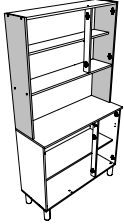
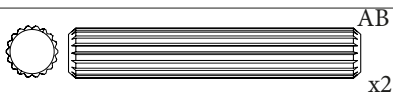
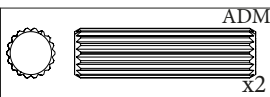
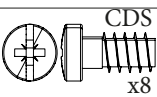

ADM

AB

AB

ADM

11

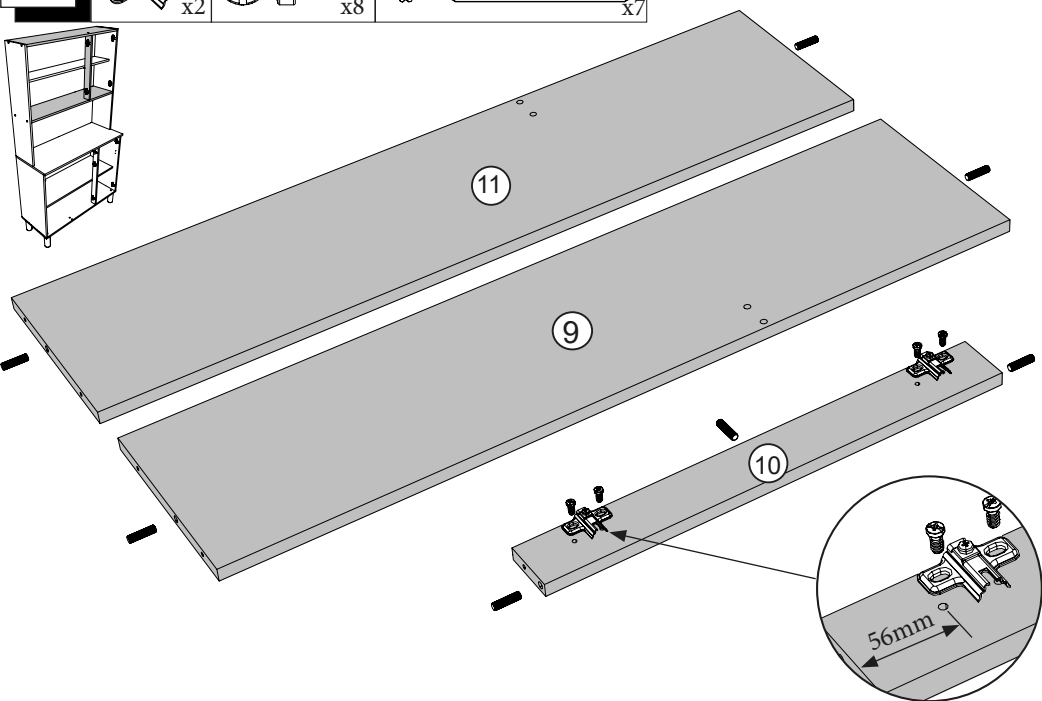
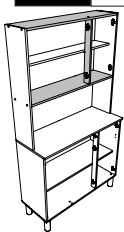
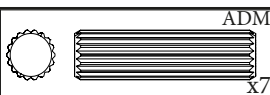
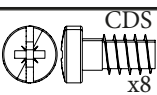

56mm

12

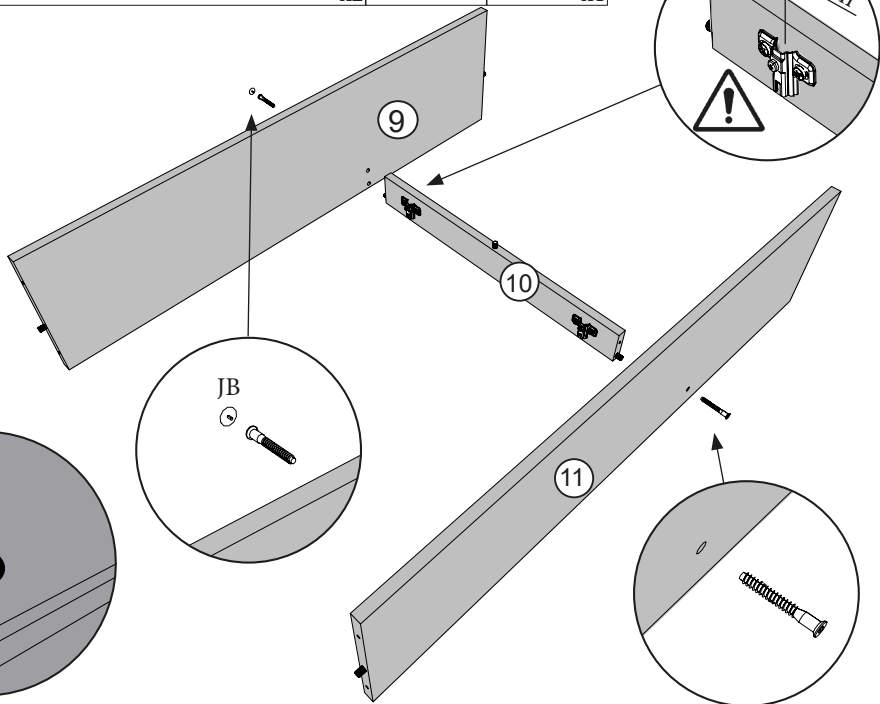
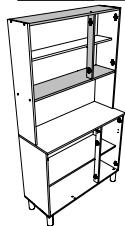
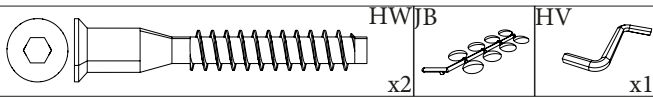

13

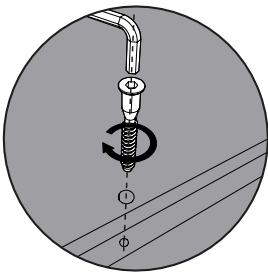
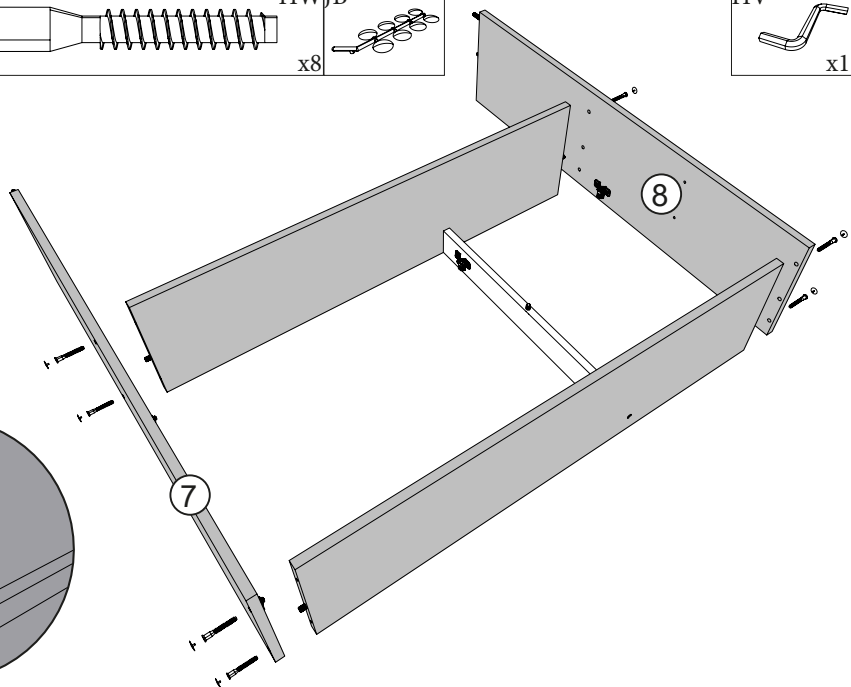
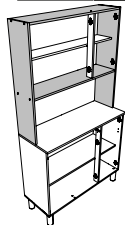
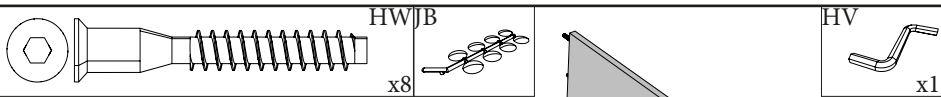

**14**

FA



x5

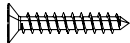

WJ/PA

x5



x16

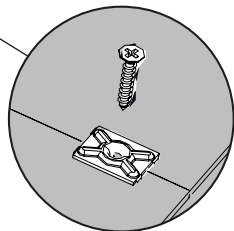
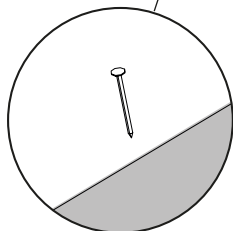
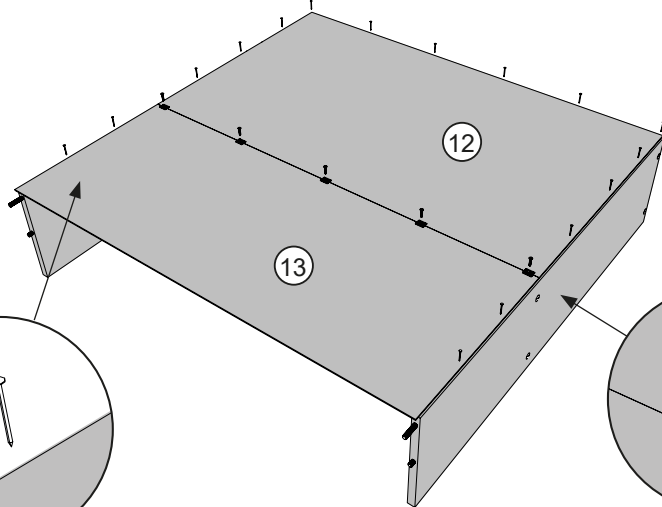
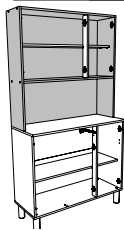

FR- Mesurer les diagonales du meuble pour vérifier l'équerrage. La mesure doit être identique.

EN- Measure the diagonals of the piece of furniture to check for straightening. The measurement must be identical.

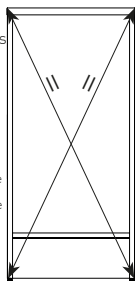
**15**

FA



x5

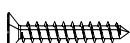

WJ

x5

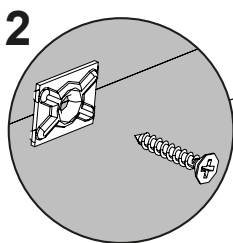
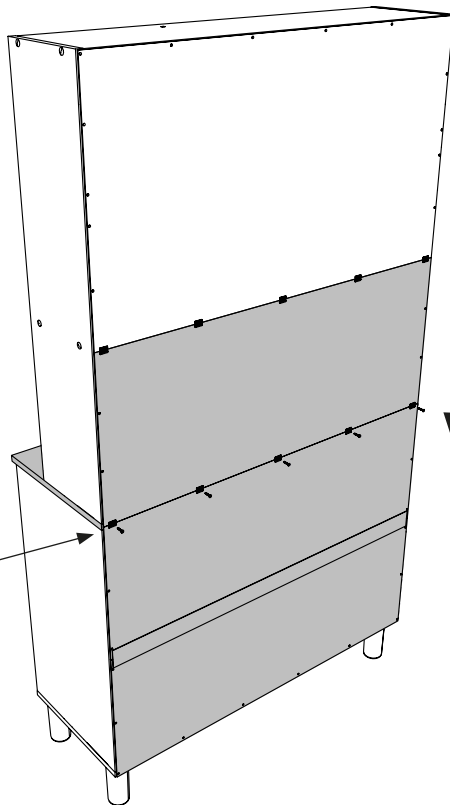

16

ZK

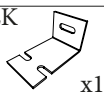

x1

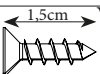

1.5cm

VAF8 BWD

x2



x8

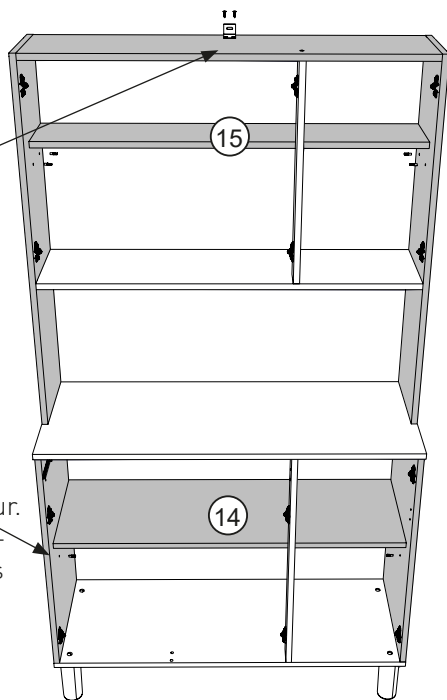
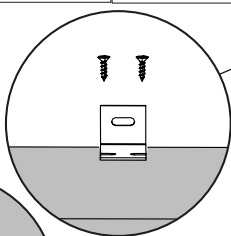
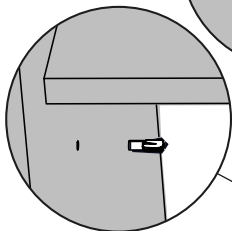
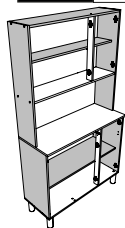

**FR**-Pour votre sécurité : Fixation du meuble au mur. Attention, la fixation doit être réalisée par une personne compétente car cela nécessite des chevilles adaptées à la nature de votre mur.

**EN**-For your safety : the unit should be secured to the wall.

NB this should be carried out by a competent person as you must use the right rawl plug for your type of wall.

17



VRZF

x2



x2

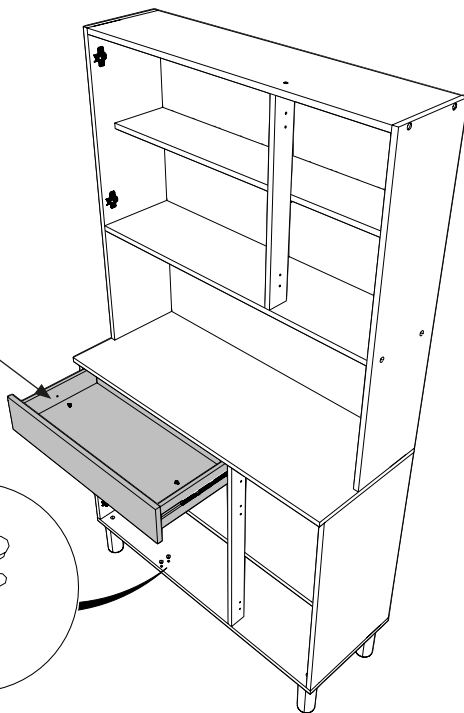
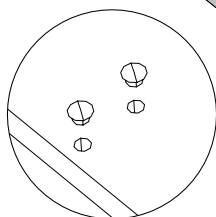
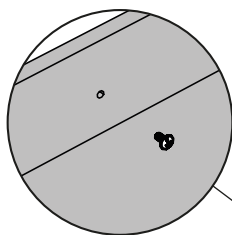
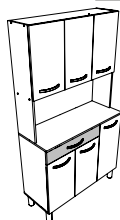

18

CDA

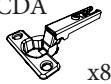

x8

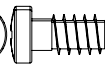

CDS PAS

x16



x4

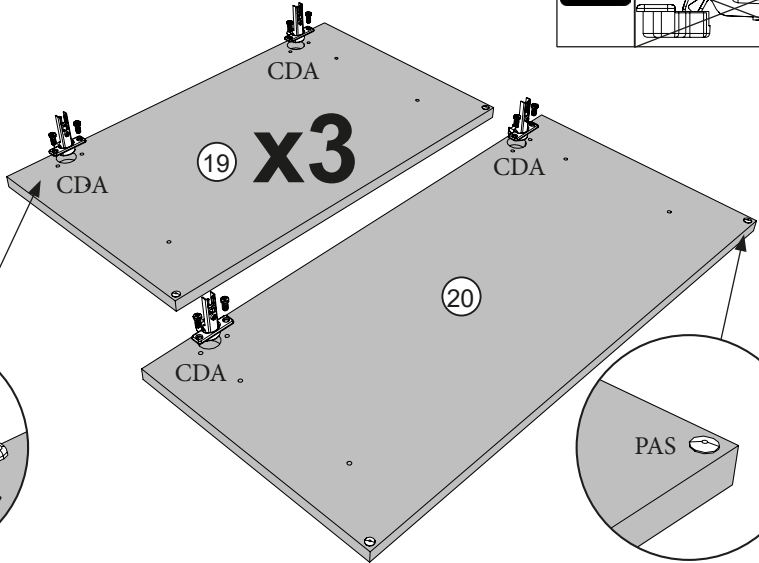
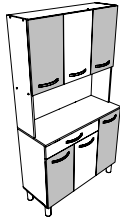
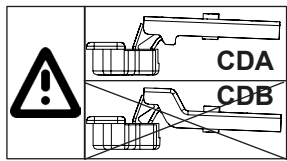

19

CDB



x4

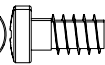

CDS PAS

x8



x2

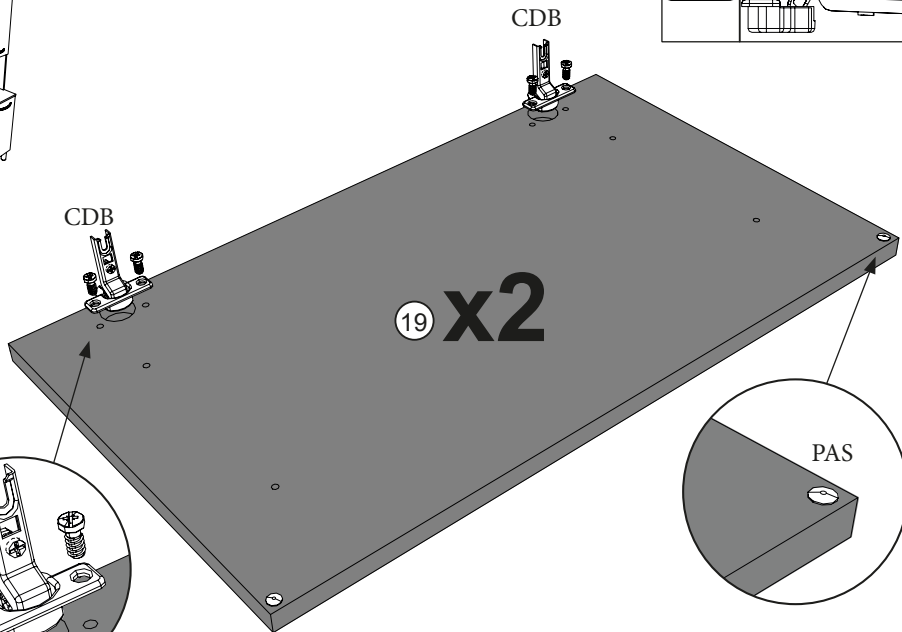
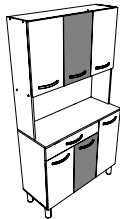
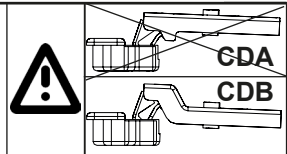

20

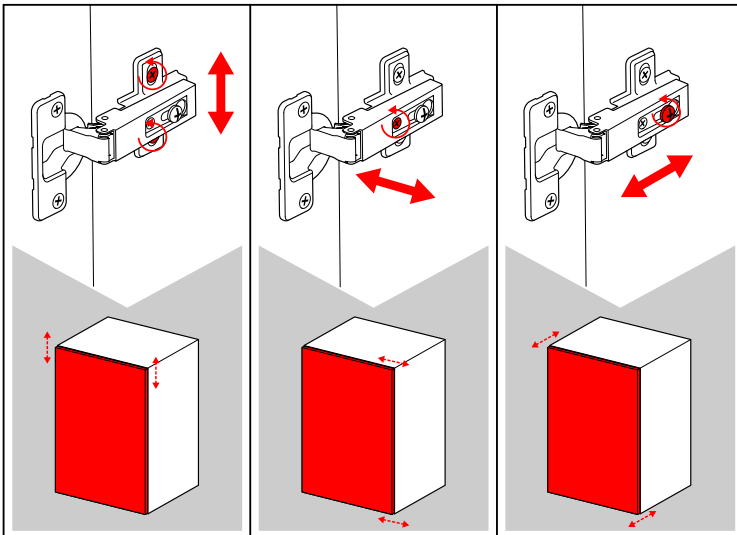
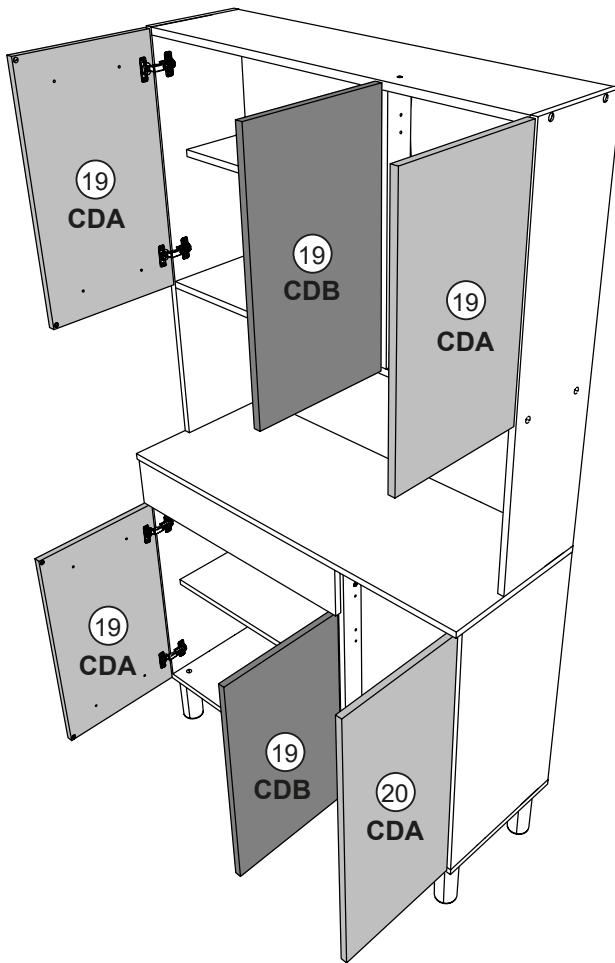
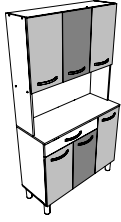

21

OO



PB

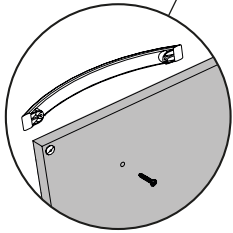
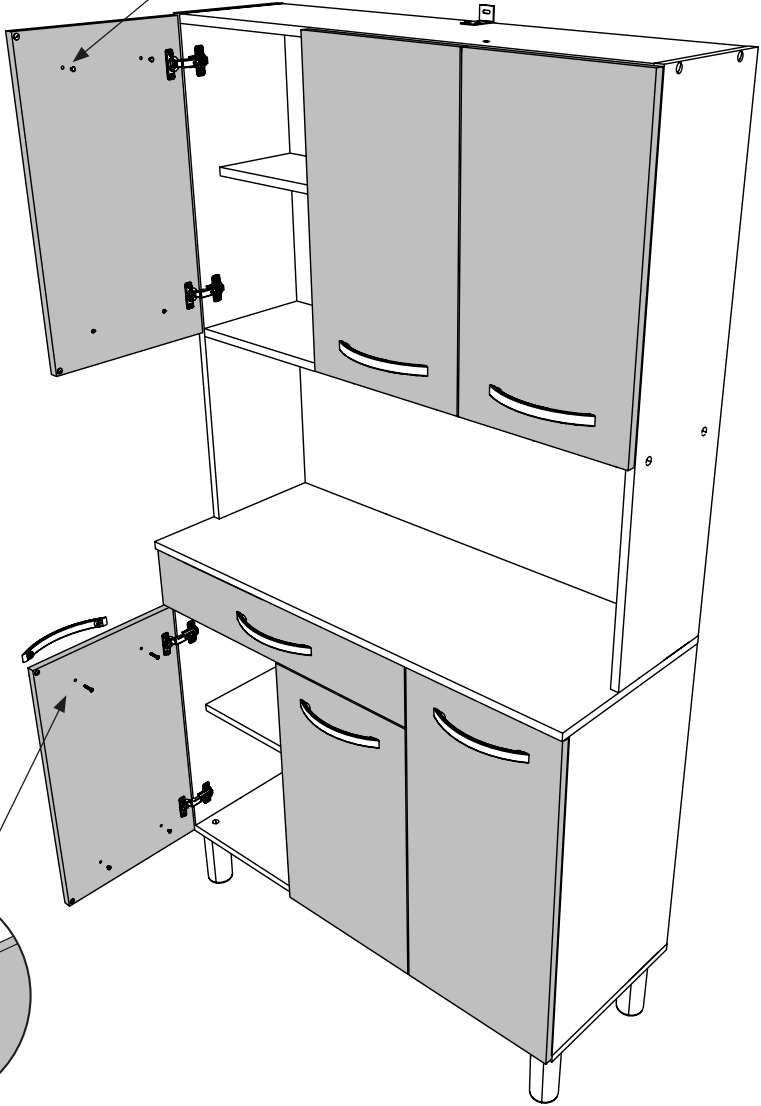
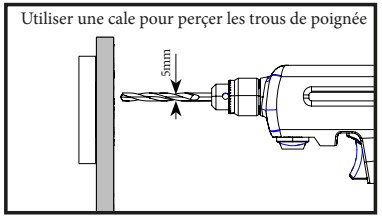
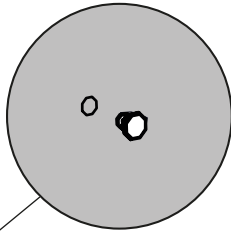
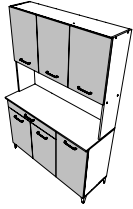
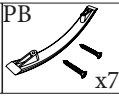

**LE TRI**  
**+ FACILE**



FR

**Pensez à  
donner ou recycler.**



OU



OU



Association

Magasin

Déchèterie

<https://quefairedemesdechets.fr>