

LKZ:80677

Modellname / Model name / Nom du modele / Modellnamn / Nome modello / Název modelu / Modelnaam / Ime modela / Número Modelo / Modell neve / Название модели / Názov modelu / Ime modela / Denumire model / Наименование на модела / Nazwa modelu

INDY

Modellnummer / Number / Numéro du modele / Numero / Номер на модела / Modello / Éislo modelu / Modell száma / Eíslo modelu / Številka modela / Număr model / Broj modela / Modelnummer / Numer modelu

1879-127-23

Type / Tipo / Típus / Typ / Тип / Tip

127

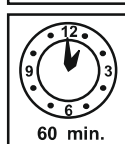
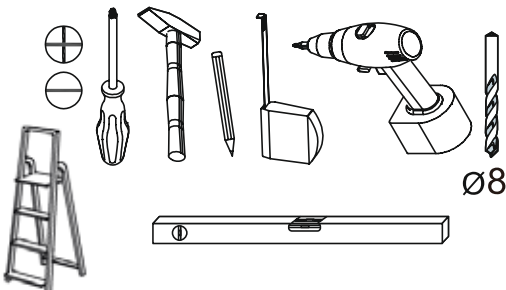
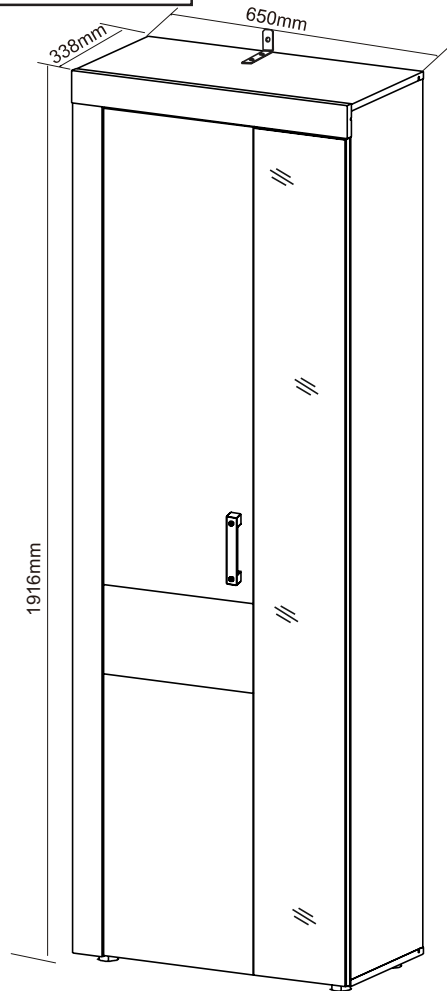
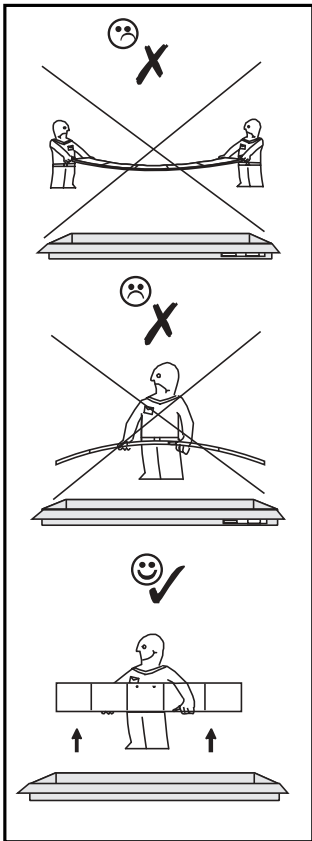
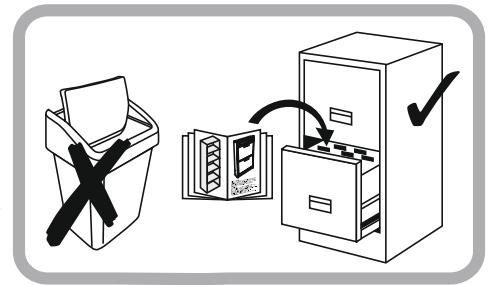
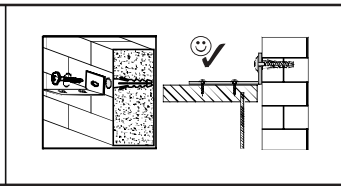
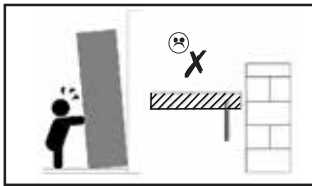
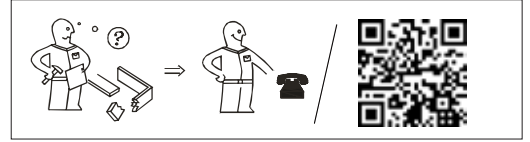
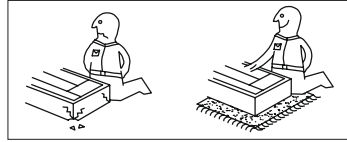
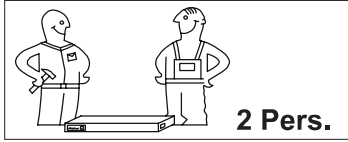

festziehen / tighten / Затягнете / serrer / stringere / utáhnout / vasttrekken / zategnuti / strângere / zwiázac / zacisnaç / szorosan meghúzni / pevne dotiahnut' / trdno pritegniti / затянуть / dra át



eindrücken / press in / enfoncer / wcisnaç / ribattere / zatláèit / Βεραπαέοε / indrukken / benyomni / stlacit' / vtisniti / tryck in / introducere prin apásare / вдавить



ausmessen / measure / mesurer / misurare / ommeten / izmeriti / miara / kimérni / izmeriti / măsurare / измерить / zmèit / Èçepeðe / mät upp / zmierzyc



drücken / press / presser / stisknout / Натиснете / vtisniti / nasinac / drukken / pritiscniti / nacinac / pritisniti / нажать / (meg)nyomni / zapasare / tryck fast / nacisnaç



einschlagen / hammer in / beverni / sla in / frapper au marteau / infossare / Zabit' / zarazit / Набитьте / zabiti / wbiç / introducere prin bëtaie / забить / zatlouct



Drehen - wenden / przekreçic - odwróciç / Keren - omdraaien / Girare - Ruotare / Okrenuti - ubrnuti / Retourner - renverser / Turn over - turn around / Ocloce - obratte / Завъртете - обърнете / Obrnite list / Întoarcepi - rotiji / Vríd runt - vänd / прокрутить - повернуть - otoèit - obrátit / elforgatni - megfordítani

LKZ-80677

Modellname / Model name / Nom du modele / Modellnamn
Nome modello / Název modelu / Modelnaam / Ime modela
Número Modelo /Modell neve / Название модели/
Názov modelu / Ime modela / Denumire model /
Наименование на модела / Nazwa modelu

INDY

Modellnummer / Number / Numéro du modele
Numero / Номер на модела / Modello
Éislo modelu / Modell száma / Eíslo modelu
Številka modela / Număr model / Broj modela
Modelnummer / Numer modelu

1879-127-23

Type / Tipo / Típus / Typ / Тип / Tip

127

Unser Direktservice für Beschlagteile

Sollte Ihnen ein Beschlagteil fehlen, können Sie diese Servicekarte direkt an die untenstehende Adresse mailen. Wir können allerdings nur Beschlagteile auf diesem Wege verschicken. Sollten Sie eine andere Beanstandung an Ihrem Möbelstück haben, so wenden sie sich bitte direkt an Ihr Möbelhaus.

Our direct order service for fitting

If a fitting part is missing, you can e-mail this service card directly to the address below. However, we can only send fitting parts in this way. If you have any other cause for complaint concerning your item of furniture, please contact your furniture store directly.

Naše přímé služby pro kování

Chybí-li vám nějaký díl z kování, můžete tuto servisní kartu odeslat e-mailem přímo na ní uvedenu adresu. Touto cestou však můžeme rozesílat jen díly kování. Pokud byste reklamovali jiný díl nábytku, obraťte se přímo na svého prodejce nábytku.

Bien etudier la notice de montage

S'il vous manque une ferrure, veuillez envoyer directement la présente carte service à l'adresse e-mail indiquée ci-dessous. Cependant, ceci nous permet uniquement d'envoyer des ferrures. Pour tout autre type de réclamation concernant votre meuble, veuillez contacter directement votre magasin d'ameublement.

Il nostro servizio diretto per l'ordine della ferramenta

Qualora Vi dovesse mancare un pezzo di fissaggio, allora Vi preghiamo di inviare questa carta di servizio immediatamente all'indirizzo sottostante. Possiamo inviare i pezzi di fissaggio solamente per mezzo di questo procedimento. Qualora dovete avere qualche altra reclamazione in merito al mobile, allora Vi preghiamo di rivolgeri direttamente al Vostro Negozio di mobili.

Нашата директна услуга за обкова

Ако липсват части от комплекта, попълнете настоящата сервисна карта и ни я изпратете на e-mail адреса, посочен по-долу. По този начин можем да доставяме само липсващи елементи от обкова. Ако установите други дефекти по мебелите, Ви съветваме да се обърнете към мебелната къща/магазин, от който сте закупили стоката.

Onze directservice voor losse onderdelen

Wanneer er een onderdeel ontbreekt, kunt u deze servicekaart direct aan onderstaand e-mailadres sturen. Wij kunnen langs deze weg echter alleen beslagdelen versturen. Mocht u een ander probleem aan uw meubel hebben, verzoeken wij u contact op te nemen met uw meubeldealer.

Nasz bezpośredni serwis części montażowych

Jeżeli brakuje części końcowych do montażu, prosimy o przesłanie nam niniejszej karty serwisowej na niżej podany adres e-mailowy. W ten sposób możemy przysłać Państwu tylko brakujące części. W przypadku innych reklamacji dotyczących mebla, prosimy zgłosić się do salonu meblowego, w którym został dokonany zakup.

Servis za okove

U slučaju da nedostaje neki od dijelova molimo vas da na dolje navedenu mail adresu pošaljete ovaj servisni obrazac. Na ovaj način mogu se dostaviti samo okovi. U slučaju da imate dodatne prigovore vezane uz komad namještaja molimo vas da se obratite izravno trgovini namještaja gdje je isti kupljen.

Direktszolgálatunk vasalatok esetén

Ha hiányzik egy vasalat, ezt a kártyát közvetlenül elküldheti az alább található címre. Azonban csakis vasalatoskat tudunk így küldeni. Amennyiben másfajta reklamáció áll fenn bútordarabját illetően, forduljon közvetlenül a bútornáához.

Náš priamy servis pre časti kovania

Ak by Vám chýbala nejaká časť kovania, môžete poslať túto servisnú kartu poslať e-mailom na nižšie uvedenú adresu. Diely kovania vieme poslať iba týmto spôsobom. Ak by ste mali inú reklamáciu ohľadom Vášho nábytku, obráťte sa priamo na Vašu predajňu nábytku.

Naše direktné služby za okovje

Če vam manjka kakšno okovje, lahko to servisno kartico pošljete po e-pošti direktno na spodnji naslov. Po tej poti vam lahko pošljemo samo okovje. Če elite reklamirati kakšen drug del pohištva, se obrnite neposredno na vašo trgovino pohištva.

Service-ul nostru direct pentru feronerie

În cazul în care vă lipsește o piesă de feronerie puteți să trimiteți direct acest card de service prin e-mail la adresa de mai jos. Noi nu putem expedia piese de feronerie decât pe această cale. Dacă aveți o altă reclamație referitoare la piesa de mobilier, atunci vă rugăm să vă adresați direct la magazinul dvs. de mobilă.

Наш прямой сервис для поставок фурнитуры

Если окажется, что Вам не хватает того или иного элемента фурнитуры, Вы можете отправить сервисную карту по факсу непосредственно на нижеприведенный адрес электронной почты. Однако, таким образом мы можем переслать лишь фурнитуру. Если же у Вас возникнут иные претензии относительно приобретенной мебели, пожалуйста, обращайтесь непосредственно в организацию, осуществившую продажу.

Vår direktservice för beslagdelar

Om du saknar en beslagdel kan du skicka detta servicekort direkt till e-postadressen som anges nedan. Tänk på att detta är den enda möjligheten att skicka beslagdelar till dig. Om du vill reklamera din

Nuestro servicio directo para accesorios

Si le falta algún accesorio, puede enviar esta tarjeta de servicio directamente a la siguiente dirección. No obstante, por este método solo podemos enviar accesorios. Si tiene alguna otra objeción sobre su mueble, consulte directamente con su mueblería.

Donatilar için doğrudan servisimiz

Bir donatınız eksikse bu servis kartını doğrudan aşağıda bulunan adrese doğrudan mail yazabilirsiniz. Sadece bu yolla donatıları gönderebiliriz. Mobilyanızda başka şikayetleriniz varsa lütfen doğrudan mobilya satıcınıza danışın.

max.



253 256
254 255

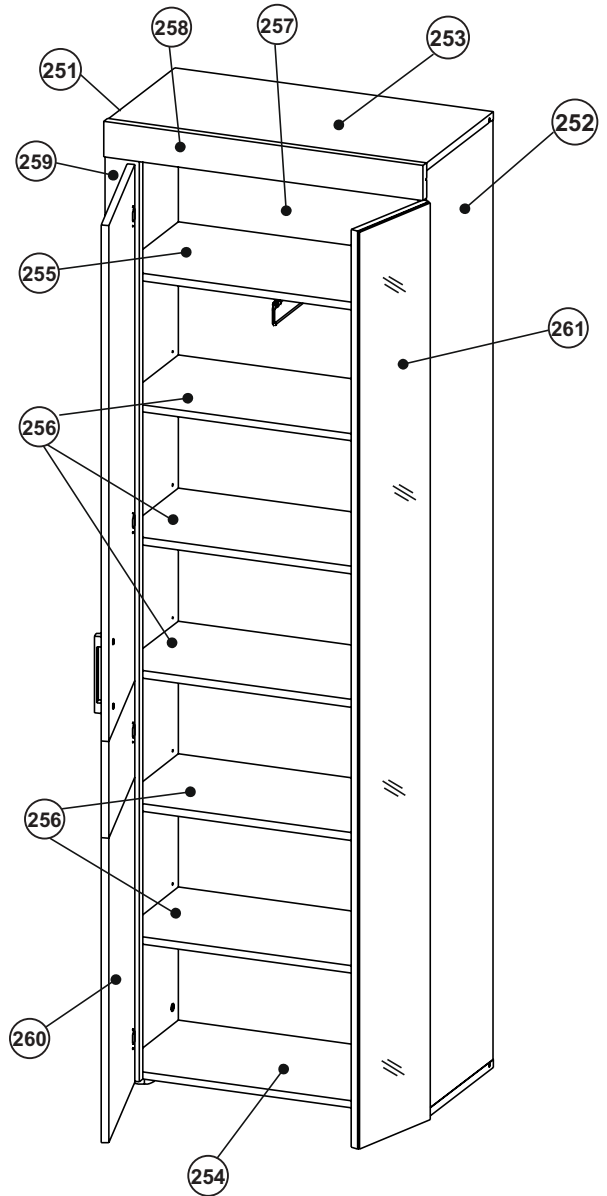

A	B (mm)		Colli	C
251	1866	320	15	2/2 x1
252	1866	320	15	2/2 x1
253	650	320	15	1/2 x1
254	650	320	15	1/2 x1
255	618	298	15	1/2 x1
256	615	290	15	1/2 x5
257	1881	633	2,7	2/2 x1
258	650	70	18	1/2 x1
259	1827	70	18	2/2 x1
260	1824	374	15	2/2 x1
261	1824	200	19	2/2 x1
B251				1/2

Grund der Beanstandung / Cause for complaint:

Möbelhaus / Furniture store:

Kunde / Customer :

Telefon / Telephone:

PLZ / Postcode :

Ort / City:

Str. +Nr / Street address :

@E-Mail:

LKZ:80677

Modellname / Model name / Nom du modele / Modellnamn
Nome modello / Název modelu / Modelnaam / Ime modela
Número Modelo / Modell neve / Название модели/
Názov modelu / Ime modela / Denumire model /
Наименование на модела / Nazwa modelu

INDY

Modellnummer / Number / Numéro du modele
Numero / Номер на модела / Modello
Ěíslo modelu / Modell száma / Eíslo modelu
Številka modela / Număr model / Broj modela
Modelnummer / Numer modelu

1879-127-23

Type / Tipo / Típus / Typ / Тип / Tip

127

B251(Colli 1/2)

B52

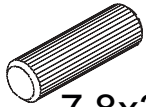

7,8x30 x12

A51

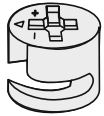

x8

M51



x20

O51

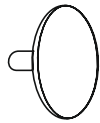

x8

C52

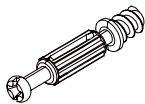

x8

N51

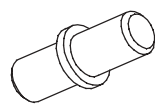

x20

R55



x4

P61

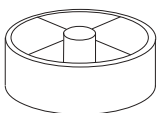

x4

D64



4x22 x4

P4



3,5x12 x4

Y4

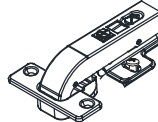

∅ 35 90° x4

D53



4x13 x16

K56

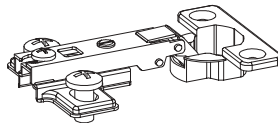

∅ 35 x4

Y87

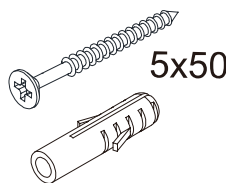

5x50

x1

I21



x1

DA70



3x14 x44

U21

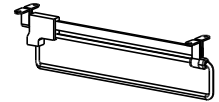

250 x1

DB52



4x30 x2

J108



164 x1

T51

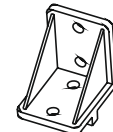

x10

J5

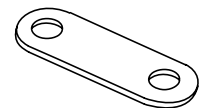

x1

F53

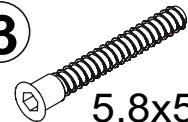

5,8x50 x4

FA51



4mm x1

D35



4x12 x2

P2



3x14 x2

Değerli müşterimiz, evde kullanım için tasarlanan iç mekan programımızdan bir mobilya satın aldığınız için teşekkür ederiz. Lütfen teslimat kapsamının eksiksiz olup olmadığını kontrol edin ve montajdan önce aşağıdaki önemli bilgileri dikkatlice okuyun ve daha sonra üçüncü şahıslar tarafından da kullanılmak üzere saklayın.

Mobilyalarımız amaçlandığı şekilde kullanılmalıdır. Amacı dışında kullanım, maddi hasarlara veya bazı durumlarda kişisel yaralanmalara neden olabilir. Mobilyalar çocuk oyuncakları değildir. Üretici veya satıcı, amacı dışında veya yanlış kullanımdan kaynaklanan hasarlar için hiçbir sorumluluk kabul etmez.

D İ K K A T: Çocuklar veya zihinsel engelli kişiler, yaralanma ve/veya bozulma riski bulunduğundan, mobilya parçalarından, sivri uçlu nesnelere, küçük parçalardan ve ambalaj malzemelerinden daima uzak tutulmalıdır.

M O N T A J: Montaj sırasında lütfen işletim, kullanım, kurulum veya montaj talimatlarınıza uyun ve uyan ve güvenli talimatlarına özellikle dikkat edin. Talimatlara uyulmaması, kişisel yaralanmaya veya mobilya hasarına/güvenlik riskine neden olabilir.

Montaj / kurulum konusunda zorluk yaşıyorsanız, lütfen servis ekibimize iletişime geçin. Ekibimiz tavsiyelerini ve desteklerini size yardımcı olacaktır. Montaj sadece uzman kişiler tarafından yapılmalıdır. Ürün/ürün parçalarında değişiklikler,

üreticiden/satıcıdan gelmeyen parçalarla/sarf malzemeleriyle değiştirilmesi veya kullanılması durumunda meydana gelebilecek hasarlar için sorumluluk kabul edilmez.

Ürünler dübel ve vida gibi duvara sabitlene araçları eklenmişse, bunlar sadece sağlam ve tek tip malzemelerden yapılmış duvarlarda kullanılmak üzere tasarlanmıştır. Bir bağlantı sadece bağlantı elemanı ve duvar arasındaki bağlantı kadar iyidir. Lütfen mobilyayı sabitlemeden önce duvarınızın hem ayakta hem de asılı mobilya için uygunluğunu kontrol edin ve sadece uygun bağlantı elemanları kullanın. Olası bir delme işleminden önce delme alanında tesisat olmadığının emin olun. Sonuçta, montaj yapan kişi duvara sabitlemekten sorumludur.

Bu aynı zamanda elektrikli parçaların ve diğer yapısal aksesuarların montajı için de geçerlidir. Elektrikli parçaların ve diğer ısıtıcı aksesuarların montajı/kurulumu sadece yetkili uzman personel tarafından yapılabilir. Tüm elektrik ve yapısal kurulumlar, eyletinizdeki geçerli standartlara ve güvenlik yönetmeliklerine uygun olarak yapılmalıdır. Işık kaynakları için lütfen sadece izin verilen aydınlatma güçlerini kullanın. Maksimum Watt değerine uyulmaması durumunda aşırı ısınma nedeniyle yangın riski söz konusudur. Yangın tehlikesi nedeniyle aydınlatmaların üstünü kapatmak yasaktır.

Mobilyaların düzgün fonksiyonu sadece düz ve yatay konumda garanti edilir. Kapılar önceden ayarlanmıştır, ancak yerel koşullar nedeniyle yeniden hizalanması/ayarlanması gerekebilir. Lütfen maksimum yük ile ilgili ağırlık bilgilerine uyun. Mobilyaların üzerine çıkılması yasaktır. Yanlış kullanım mobilyaların devrilmesine neden olabilir. Bunu önlemek için mobilyalar her zaman devrilmeye karşı emniyete alınmalıdır. Aşırı yük/aşırı zorlama durumunda (özellikle oyun oynayan çocuklar, insanlar, malzeme veya diğer uygunsuz etkilere nedeniyle) kırılma ve yaralanma riski söz konusudur. Kalıcı sağlamlığı güvenceye almak için tüm vidalar ve yük taşıyan bağlantı noktaları 5-6 hafta sonra tekrar sıkılmalıdır.

B A K I M:
-Mobilya bakımıyla ilgili notlar-
Ürününüzün keyfini olabildiğince uzun süre çıkarabilmemiz için lütfen uygun mobilya bakımıyla ilgili talimatlarımızı dikkate alın.
Temizlik sırasında temiz, kuru ve yumuşak pamuklu bir bez kullanın. Mobilyanızın kapsamlı bir temizliğe ihtiyacı varsa, bezi biraz su veya mobilya temizleyicisiyle nemlendirilebilir ve ardından temizlenen eşyaları kurutabilirsiniz. Metal ve cam parçaları, üzerindeki bakım talimatlarına göre piyasada bulunan metal ve cam temizleyicilerle en iyi şekilde temizleyebilirsiniz. Temizlik maddeleri, mobilya temizliği için uygun olduklarının açık bir göstergesini taşımazdır.

Hiçbir koşulda buharlı temizleyiciler, kostik, aşındırıcı veya etkilerine aşına olmadığınız diğer maddeleri kullanmamalısınız.

D İ K K A T: Çok parlak yüzeyler teslimat sırasında koruyucu bir folyoyle korunur. Bunu tamamen monte edilene ve tozu temizlenene kadar mobilya üzerinde bırakın. Koruyucu folyonun çıkarıldığı çok parlak elemanlar ancak 72 saat sonra temizlenebilir ve kullanılabilir (ortam havasında son katlaşma süresi). Yüzeylere keskin nesnelere zarar vermeyin ve asla güçlü güneş ışığına maruz bırakmayın.

T A S F İ Y E
-Tasfiyeyle ilgili notlar-
Çevre için lütfen türüne göre ayrılmış ambalaj atıklarını doğaya değil, bunları için sağlanan atık/geri dönüşüm kutularında tasfiye edin.
Hasarlı veya kullanılmaz mobilyalar, her bir parçanın geri dönüştürülmesi için özel geri kazanım tesislerine gönderilebilir.

Artık kullanılmayan ancak hala işlevsel olan mobilyaların hemen tasfiye edilmesi gerekmez. Bunları örneğin hayır kurumlarına bağışlayın.

Yeni mobilyalarınızı güle güle kullanın.

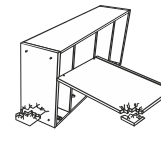
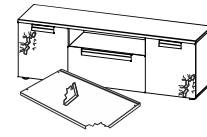
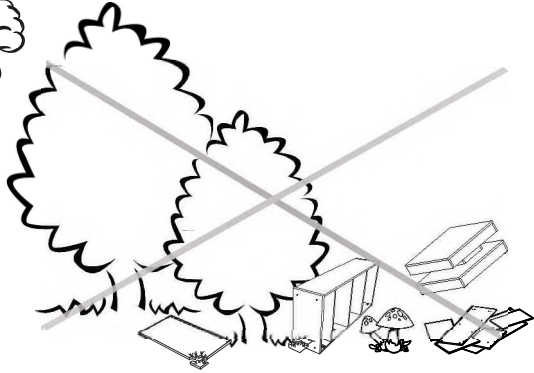
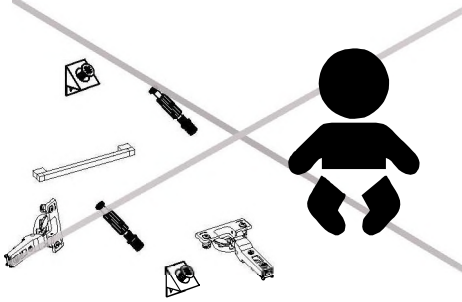
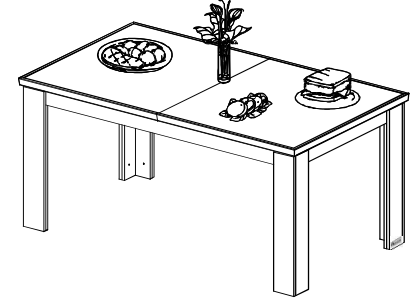
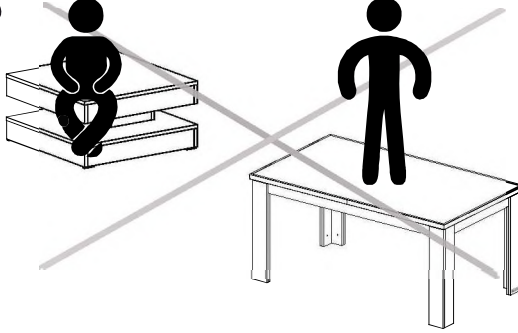
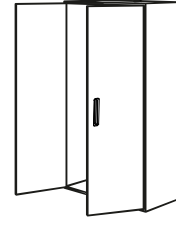
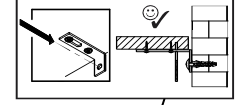
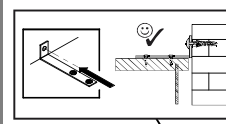
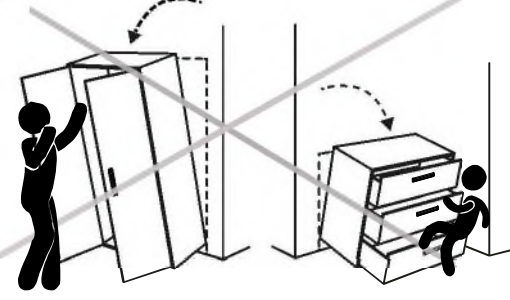



ACHTUNG

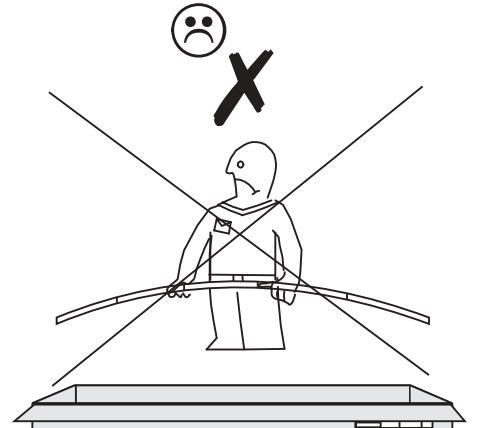
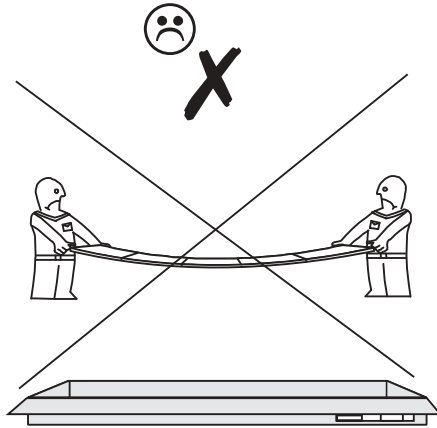

1

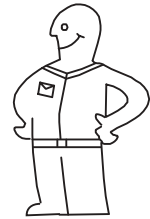
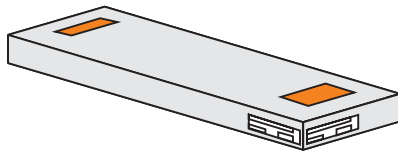

2

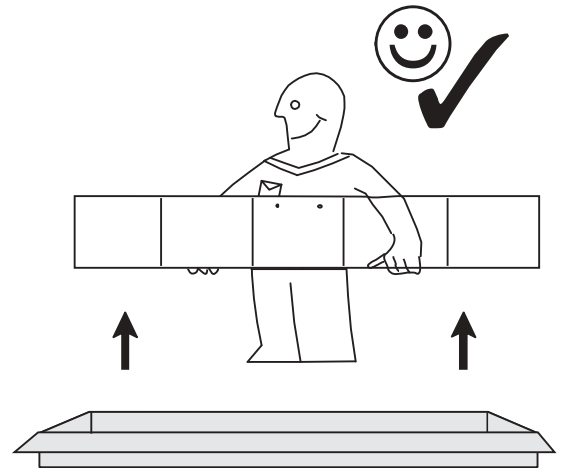
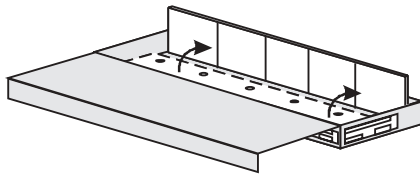



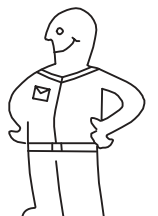
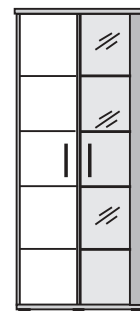
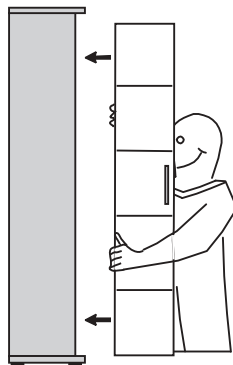

3

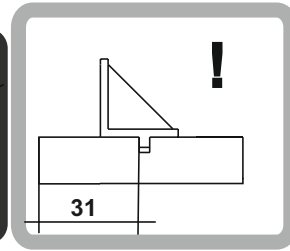
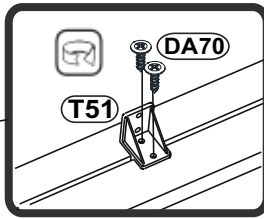
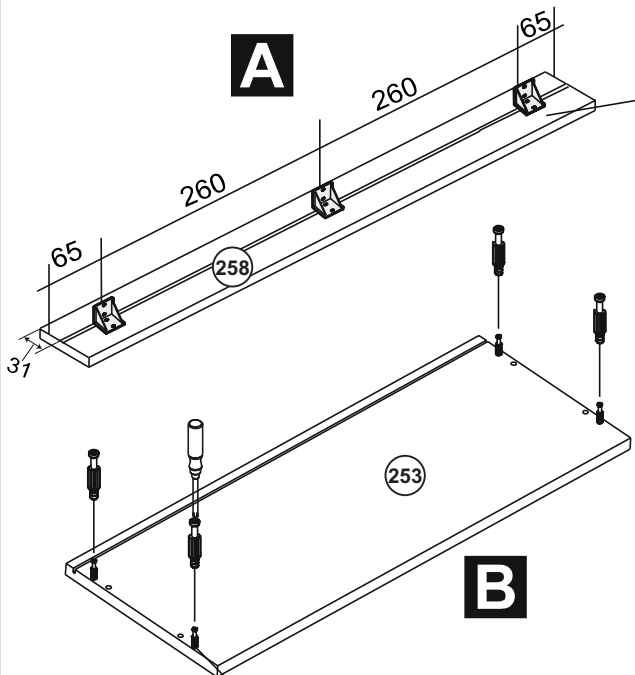

1



- B52**  7.8x30 x4
- A51**  x2
- C52**  x6
- T51**  x3
- DA70**  3x14 x12

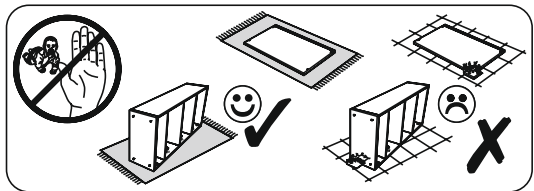
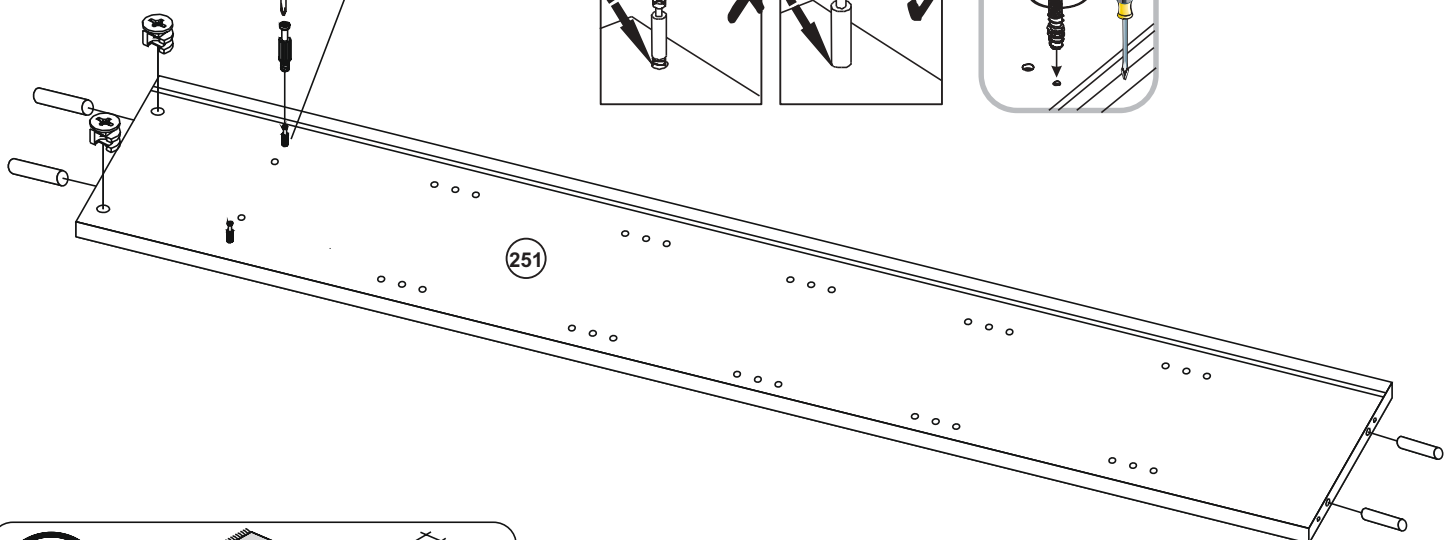
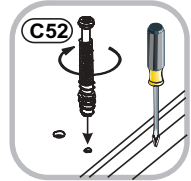
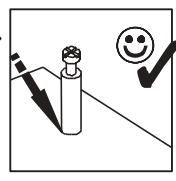
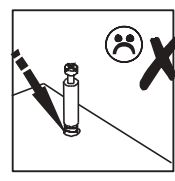
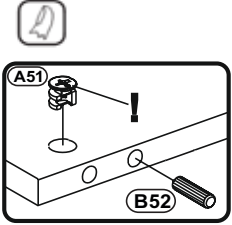
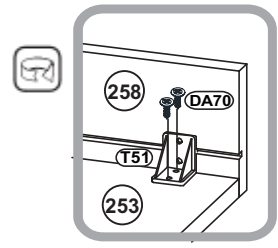
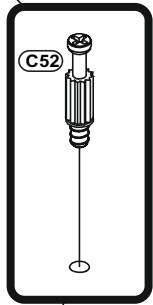
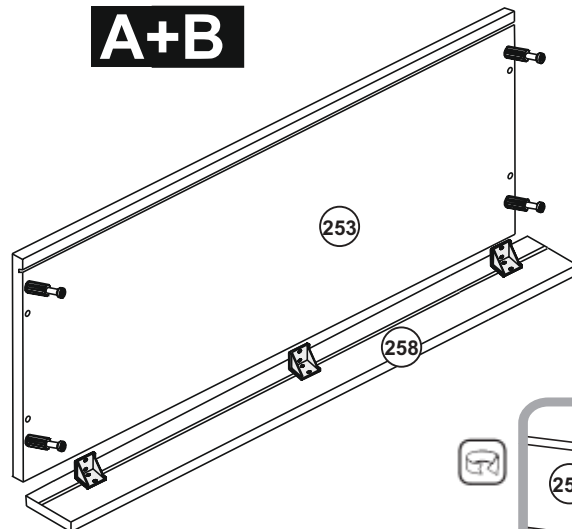

2

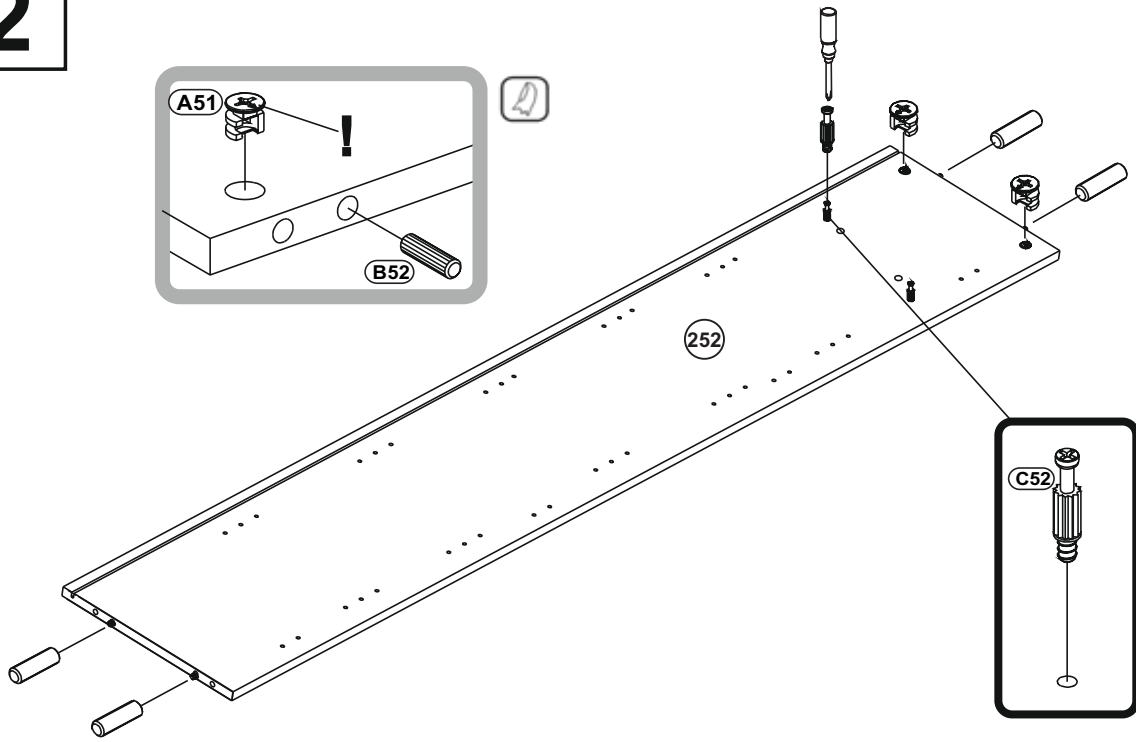
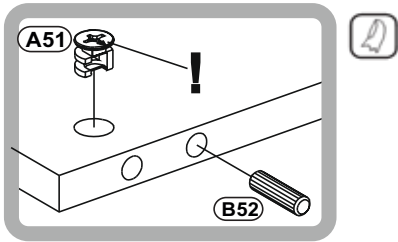

- A51** x2
- B52** 7,8x30 x4
- C52** x2
- T51** x7
- DA70** 3x14 x14
- J5** x1
- P2** 3x14 x1

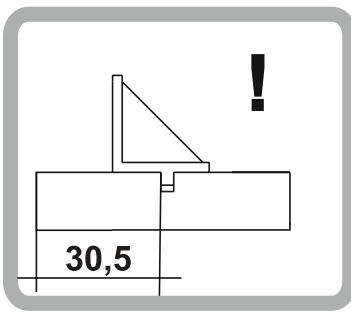
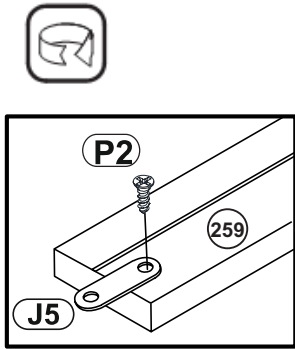
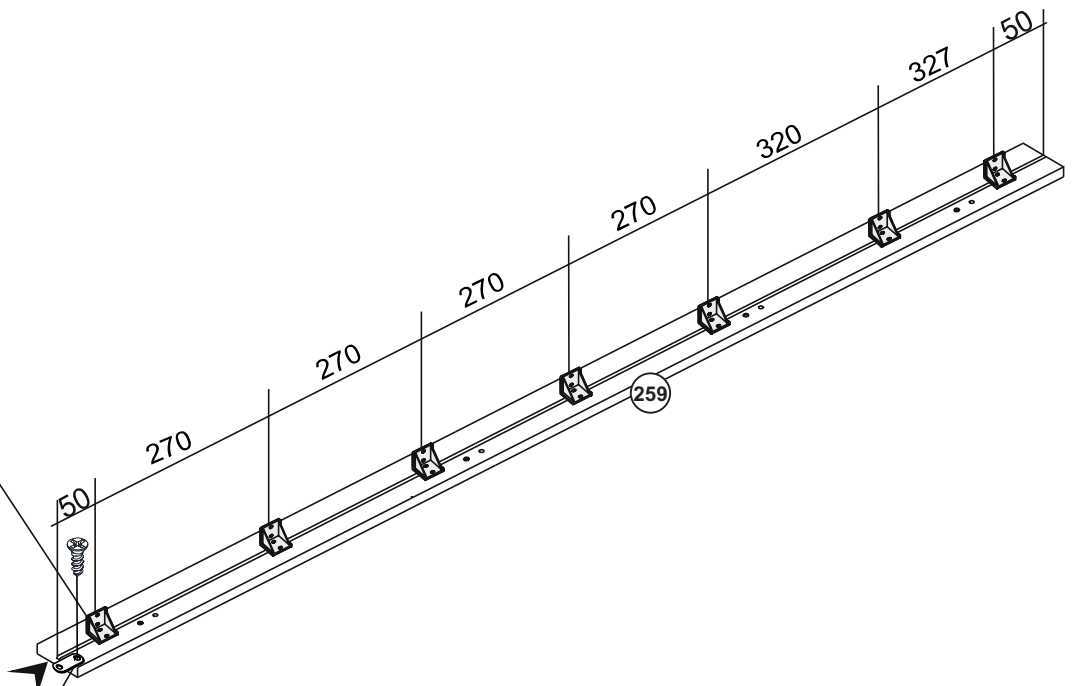
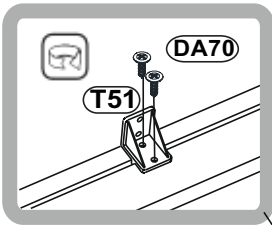
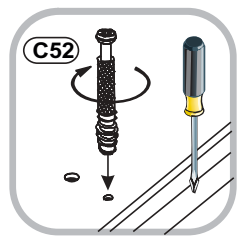
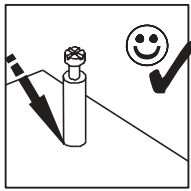
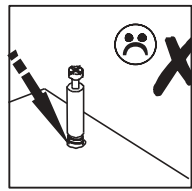



3

A51  x4

B52  7,8x30 x4

P4  3,5x12 x4

U21  250 x1

P61  x4

D64  4x22 x4

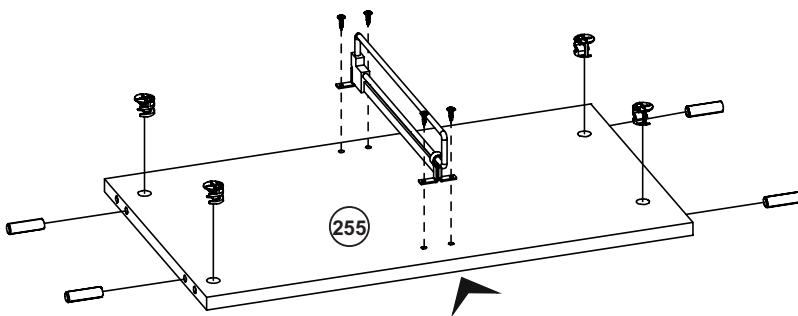
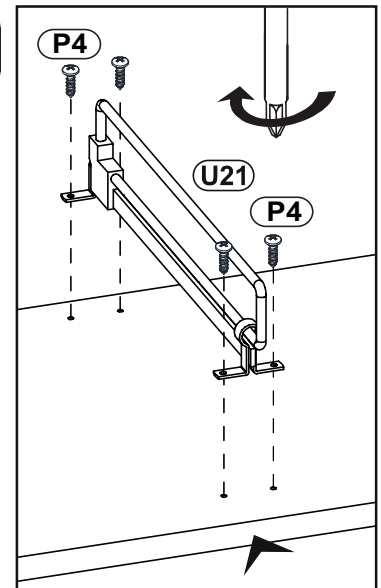
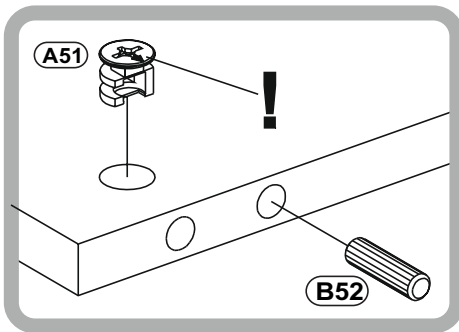
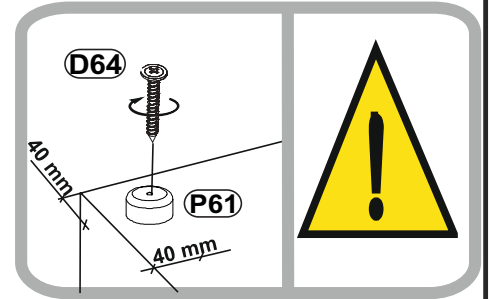
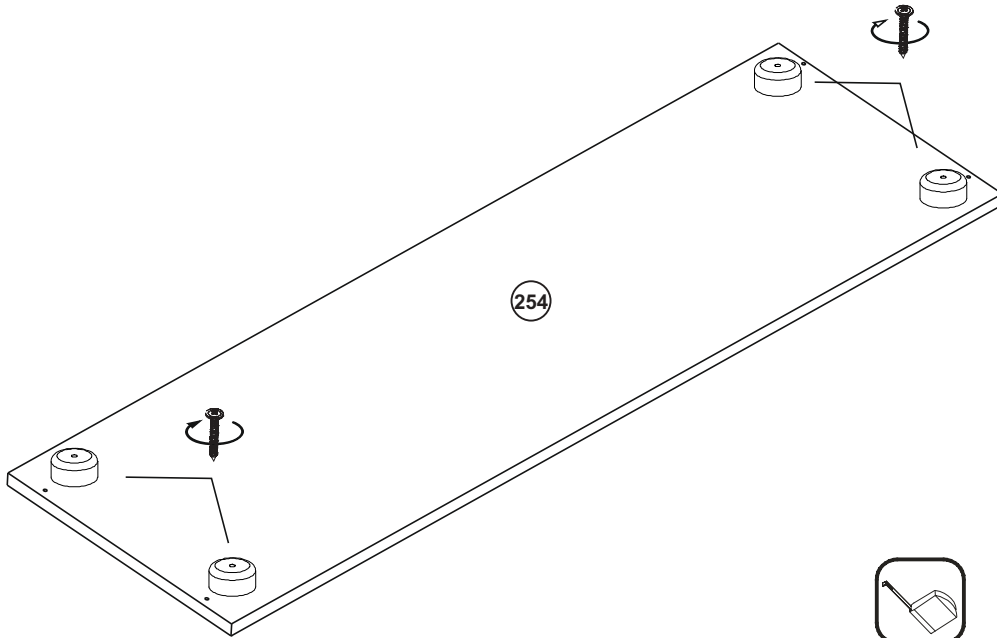

4

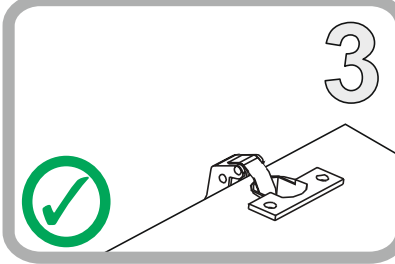
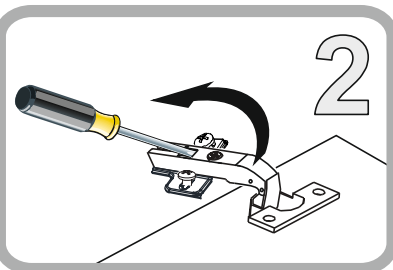
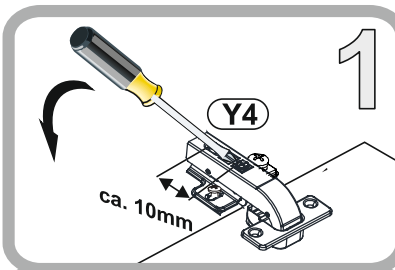

Y4		Ø 35	90°	x4
D53		4x13		x16
K56		Ø 35		x4

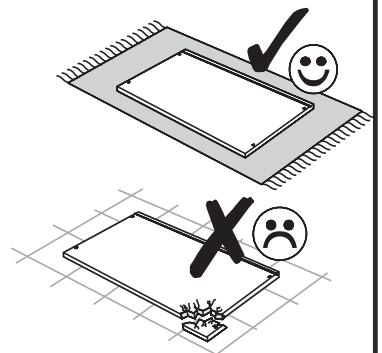
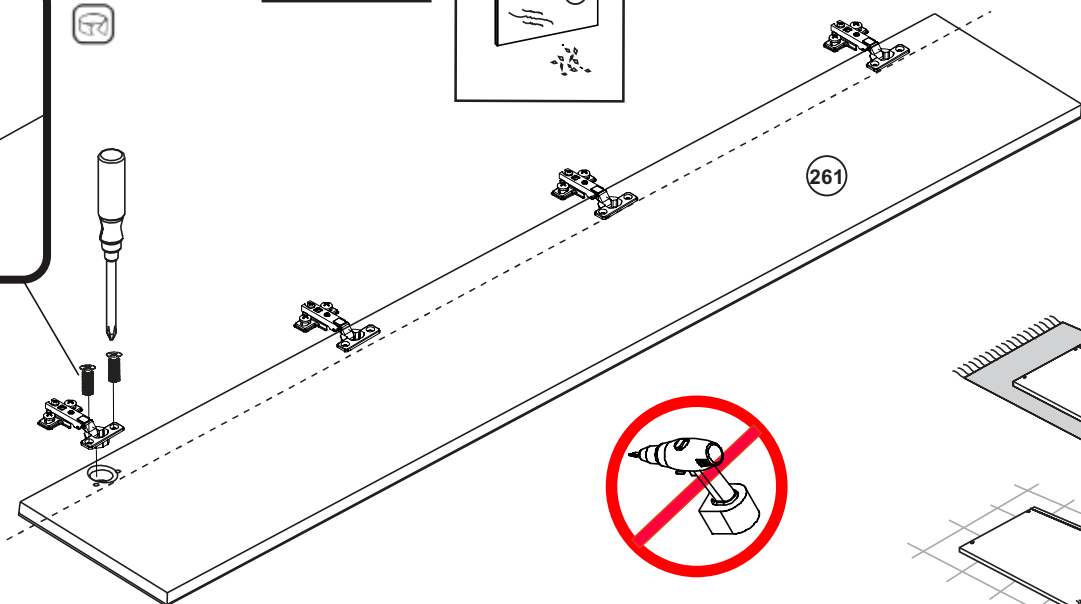
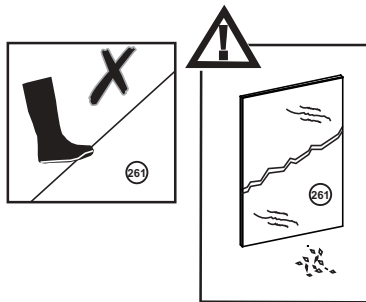
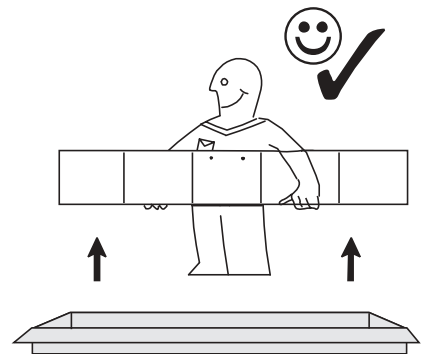
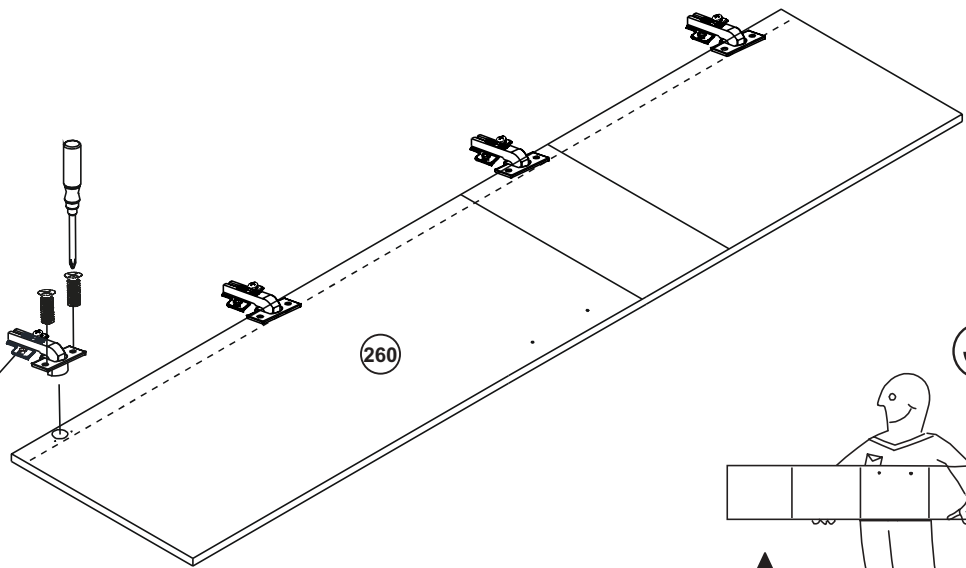
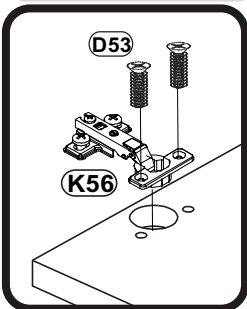
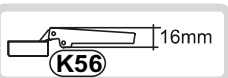
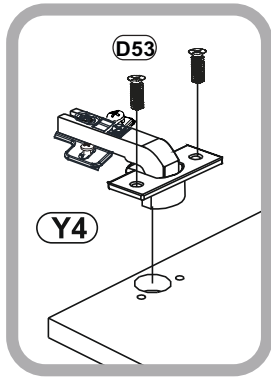
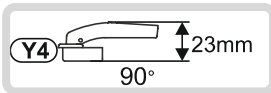

5

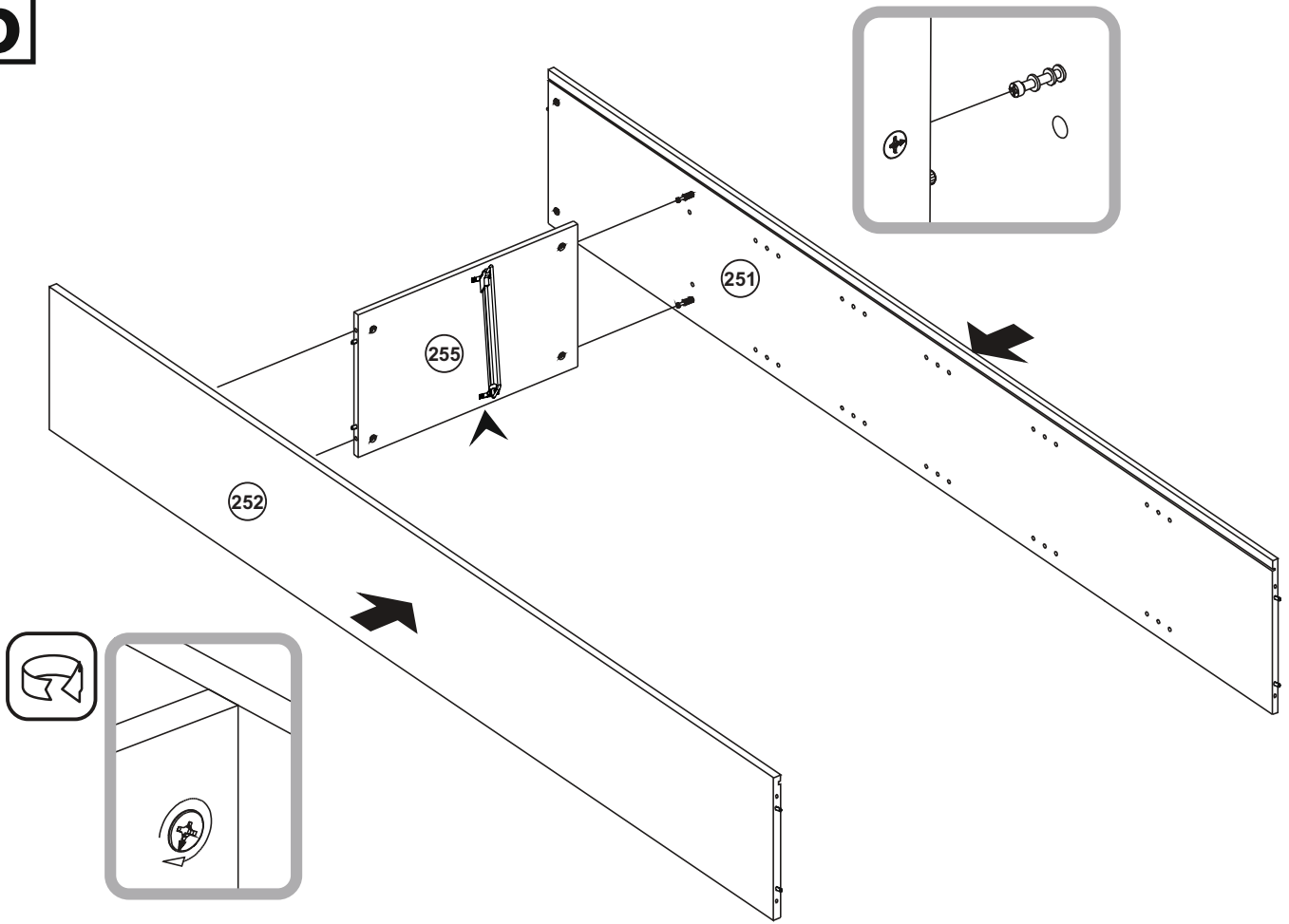

6

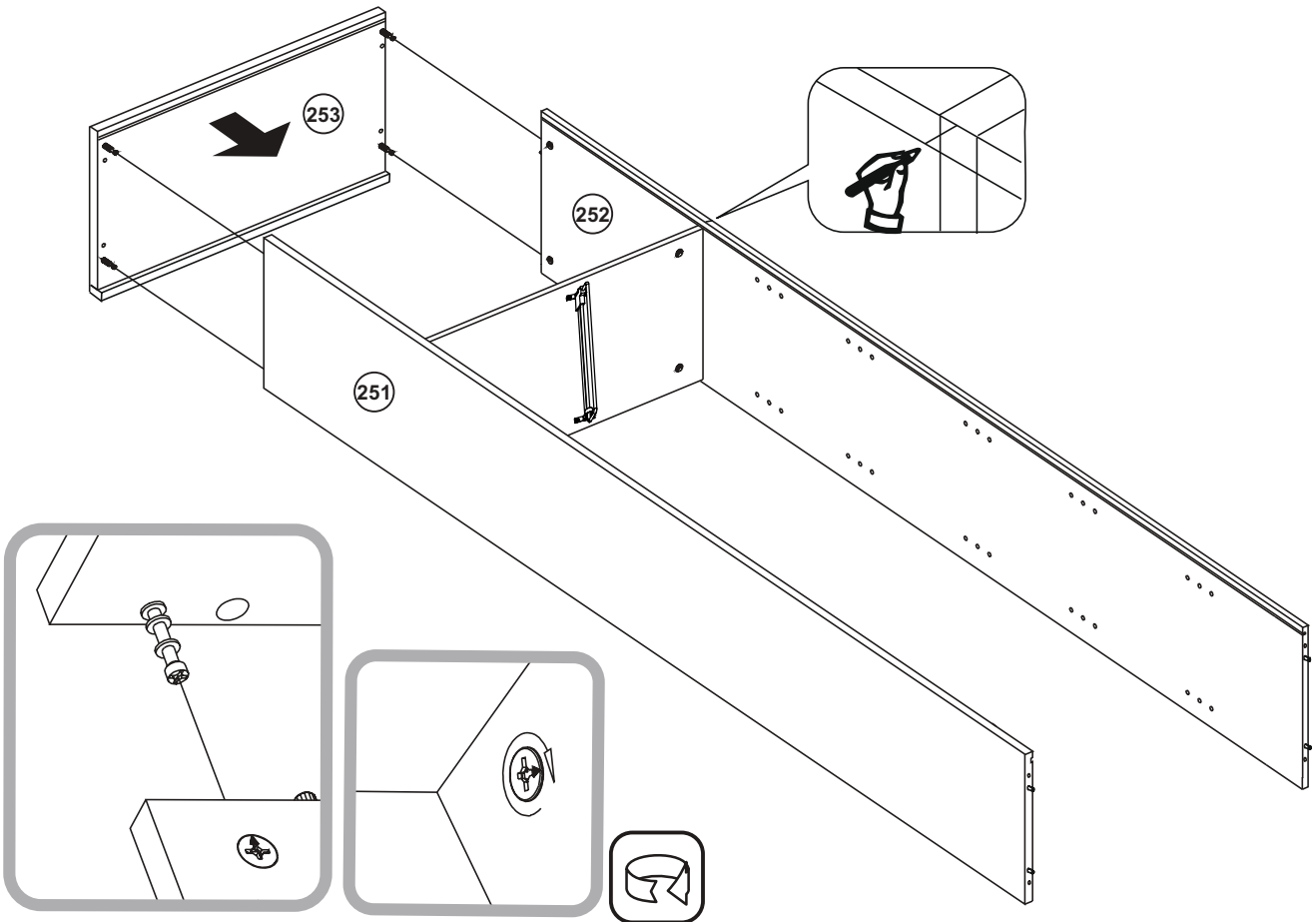

7

F53 5,8x50 x4

FA51 4mm x1

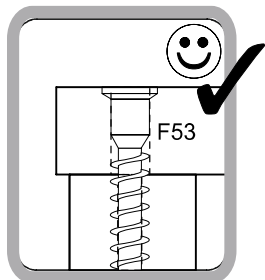
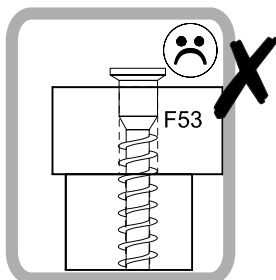
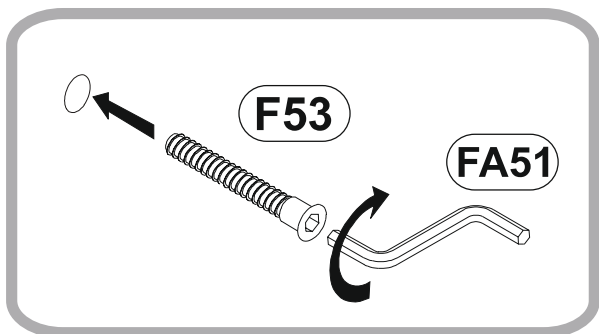
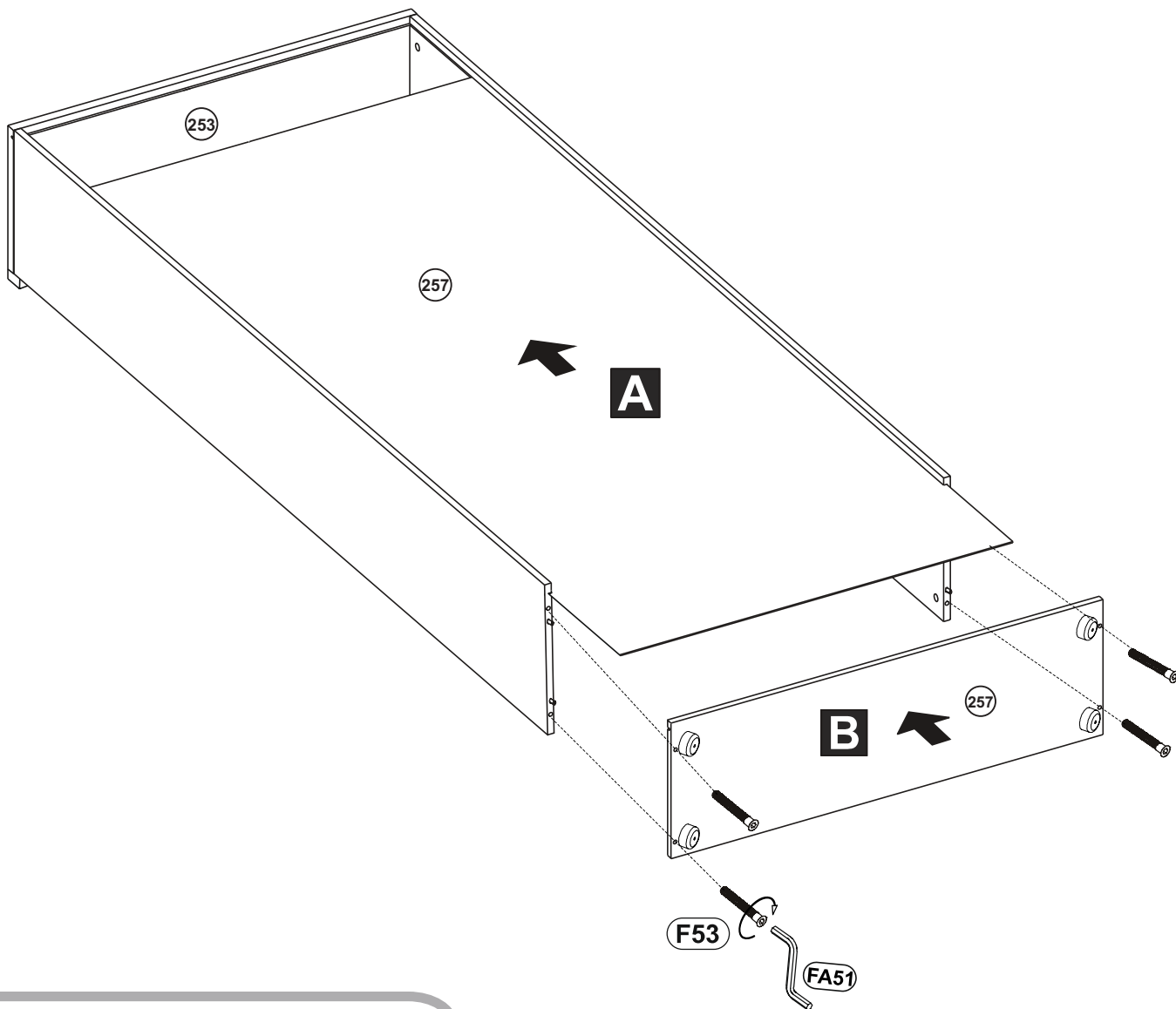

8

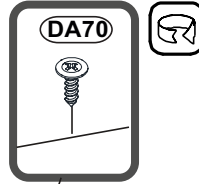
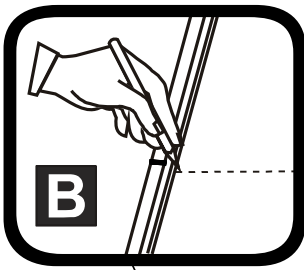

DA70 3x14 x18



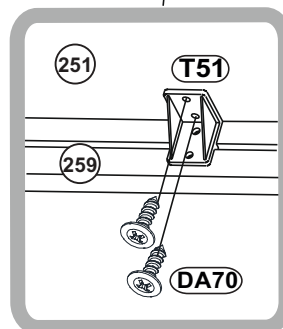
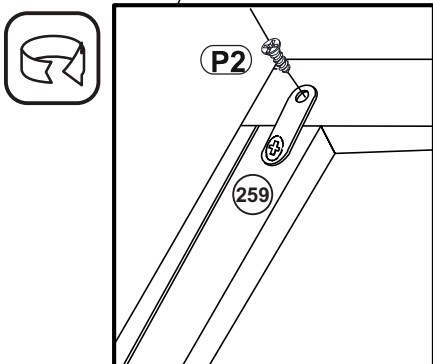
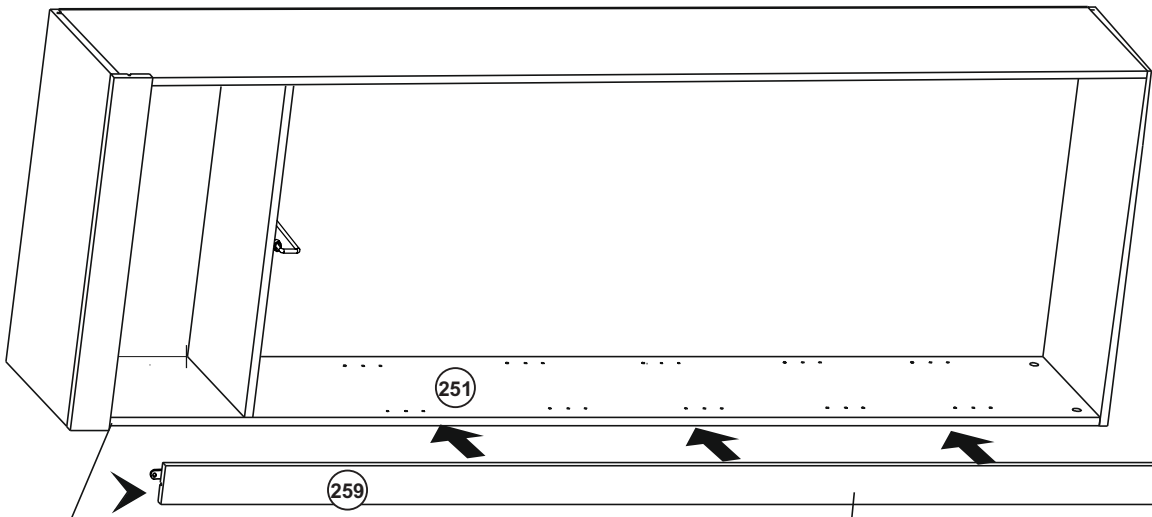
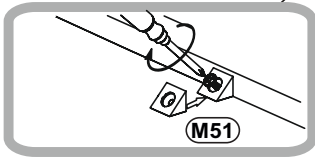
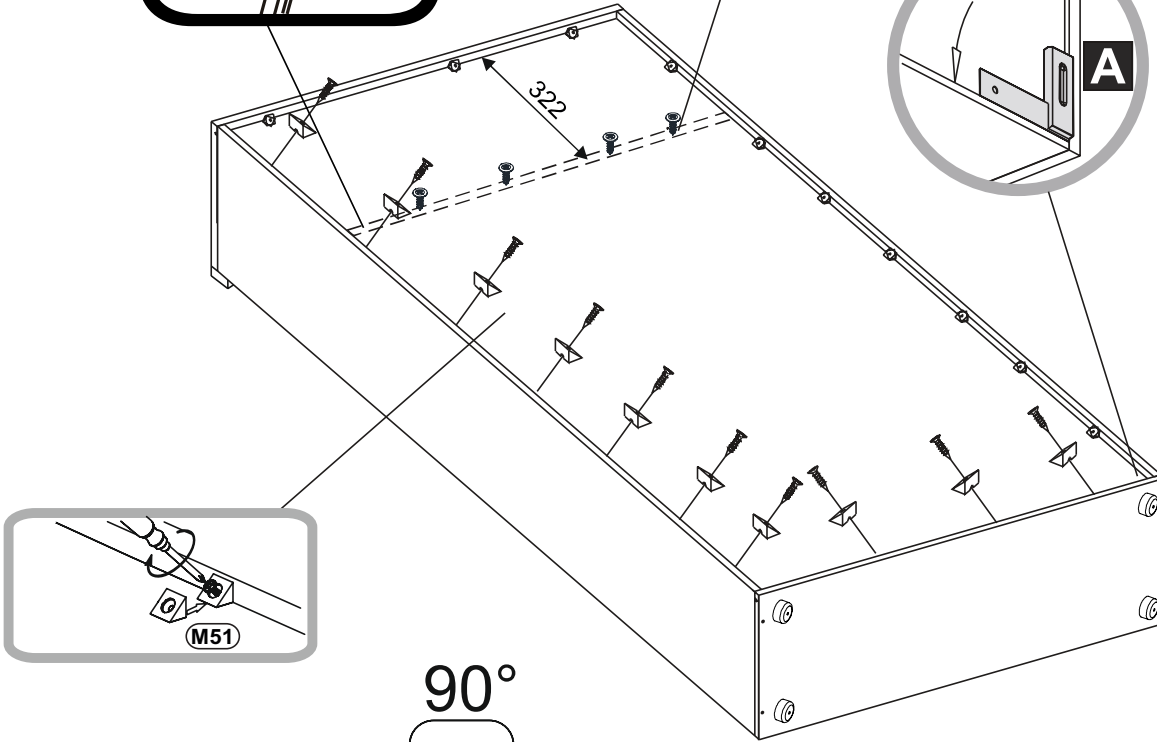
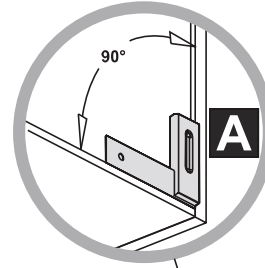

M51 3x16 x20

P2 3x14 x1

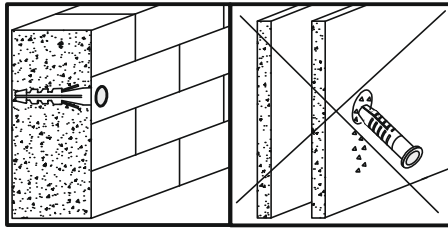

9



- Y87**  5x50 x1
- I21**  x1
- D35**  4x12 x2
- N51**  x20
- O51**  x8

C

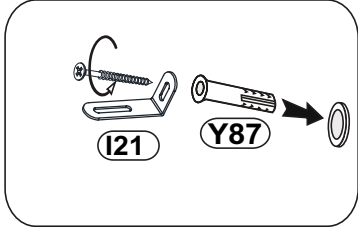

B

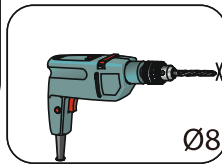

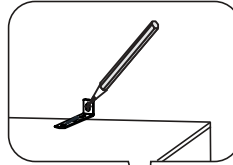

A

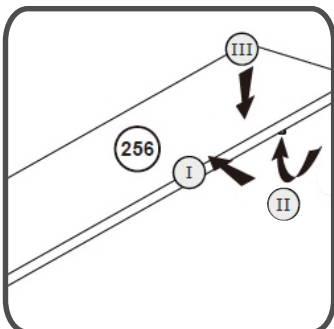
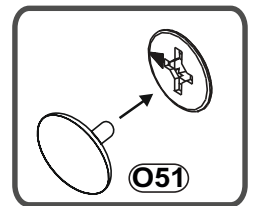
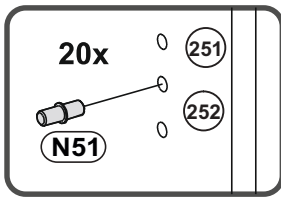
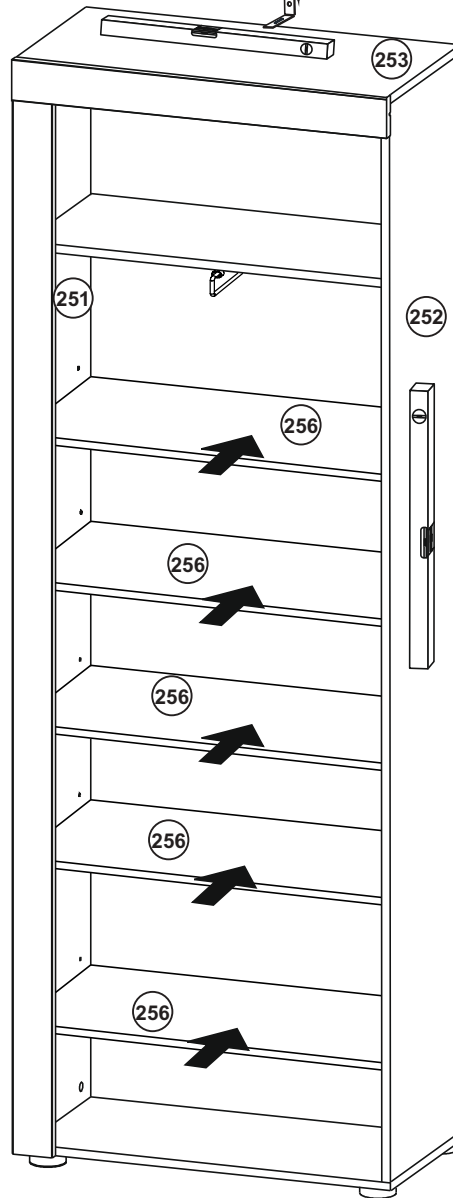
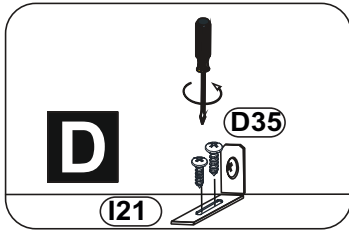

D



10

- R55**  x4
- J108**  x1
- DB52**  4x30 x2

