

PAMELA 2

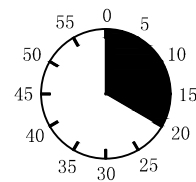

1

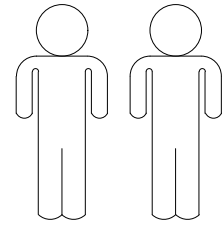
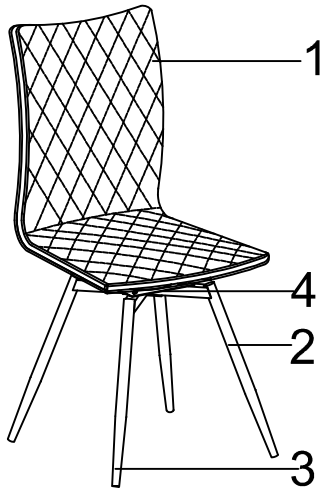
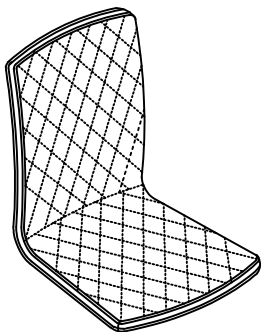

2

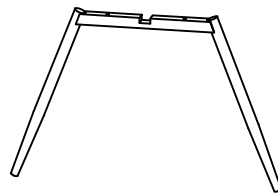

3

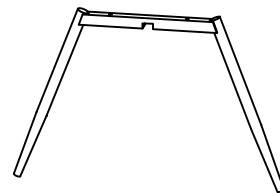

4





1	1X
2	1X
3	1X
4	1X



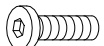

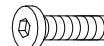
1/1

A	M6*20
	10X

B	M6*30
	2X

C	Ø18*Ø6.5*1.5
	12X

D	Ø20*Ø8*8
	2X





E	T3.0*90*90
	1X

F	4mm
	1X

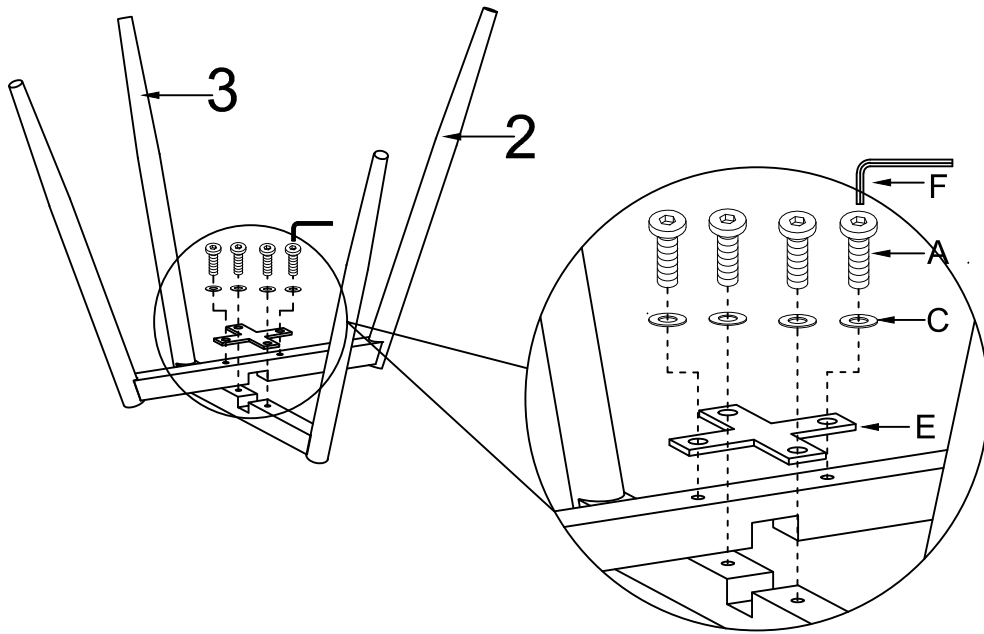
I.



1.

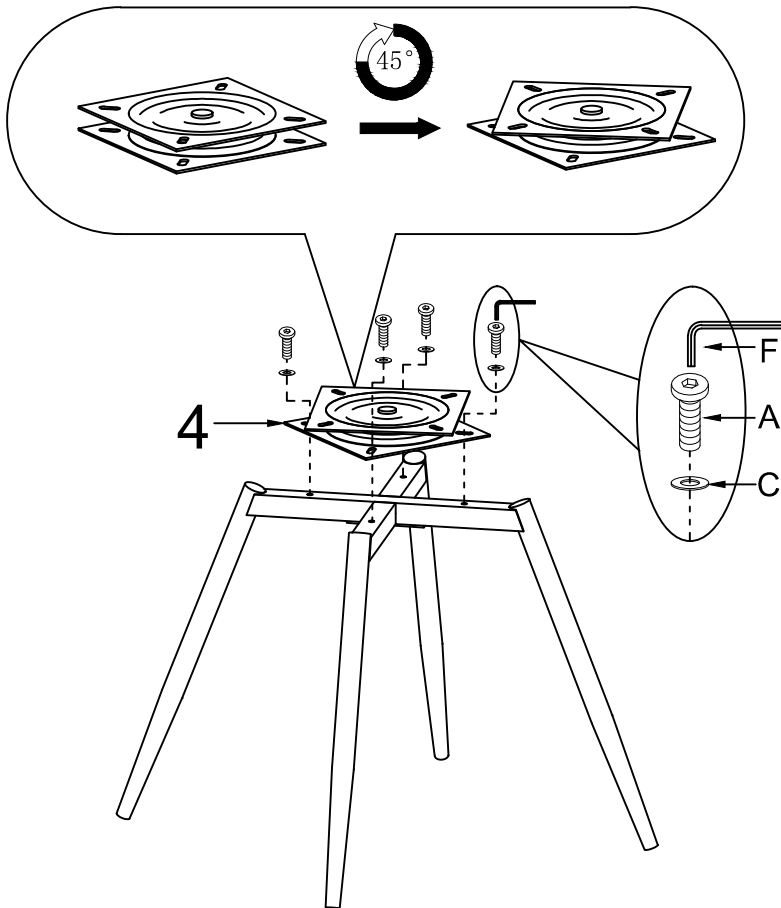

A	M6*20		4X
C	Ø18*Ø6.5*1.5		4X
E	T3*90*90		1X
F	4mm		1X
			

2.



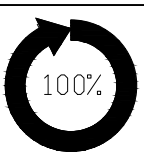



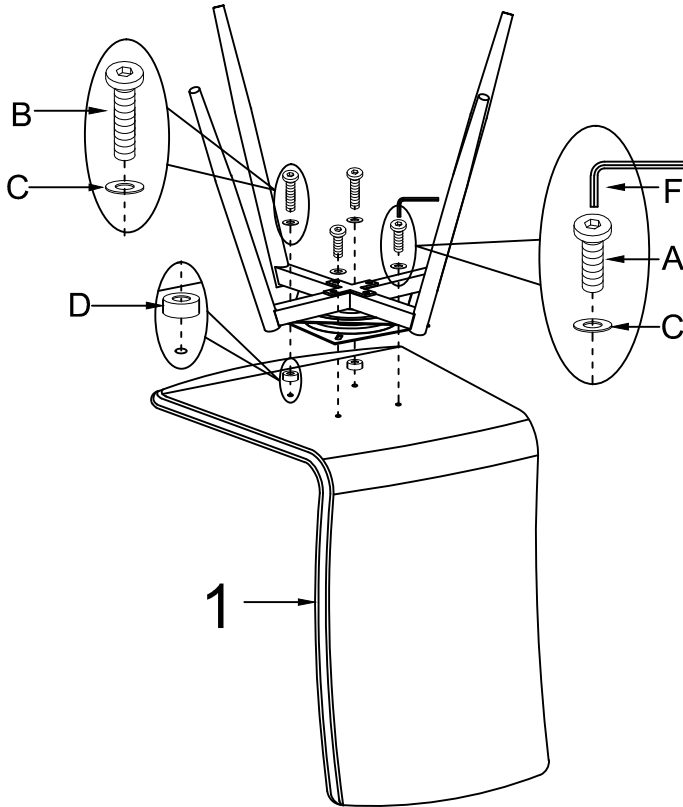

A	M6*20		4X
C	Ø18*Ø6.5*1.5		4X
F	4mm		1X
			



II.

3.



A	M6*20		2X
B	M6*30		2X
C	Ø18*Ø6.5*1.5		4X
D	Ø20*Ø8*8		2X
F	4mm		1X
			



F	4mm		1X
			



LE TRI
+ FACILE



+



Séparez les éléments avant de trier