

24770200

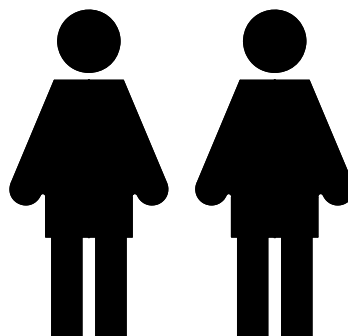
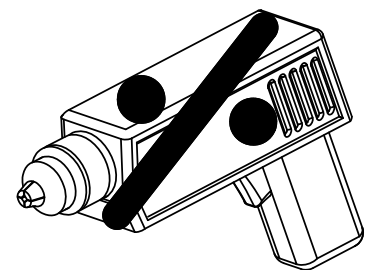
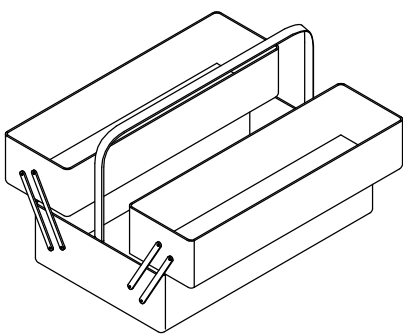
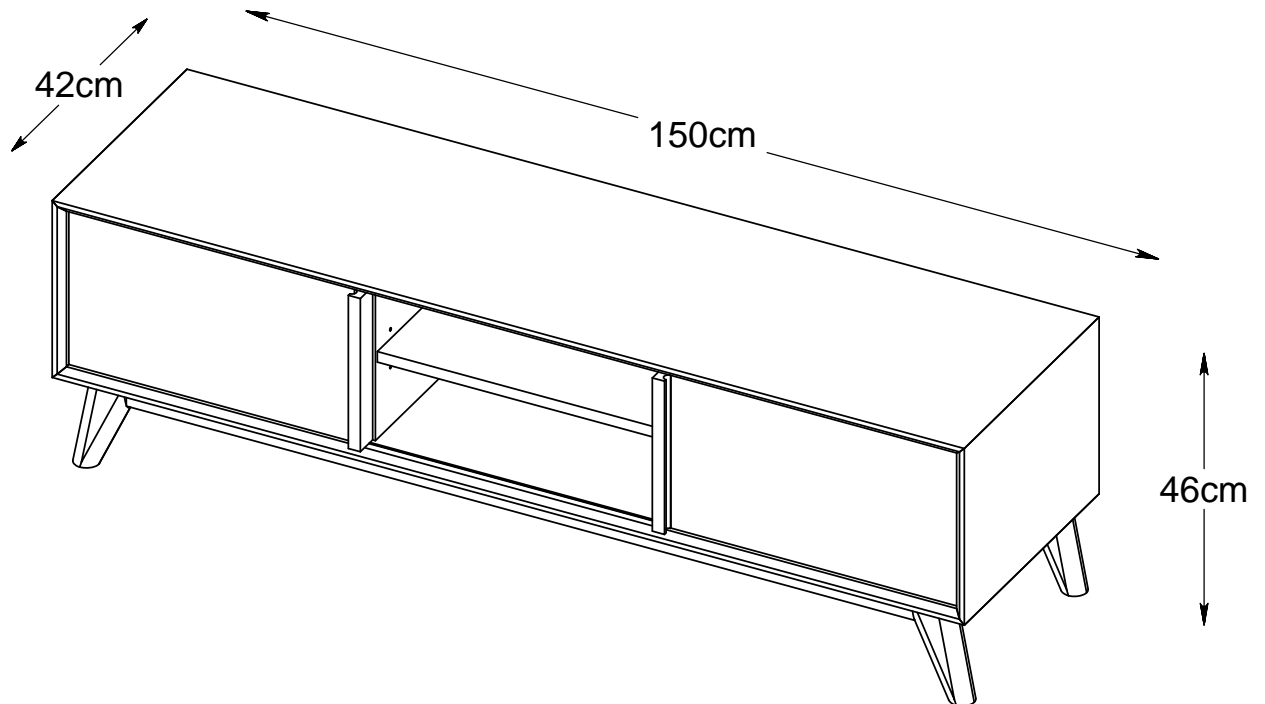

WICHTIG - FÜR SPÄTERE VERWENDUNG  
AUFBEWAHREN - SORGFÄLTIG LESEN

IMPORTANTE, conservare per utilizzi futuri,  
leggere attentamente.

VIGTIGT - Samvejledningen skal opbevares  
i arkiv til senere brug - Skal gennemlæses nøje

NOTICE - These instructions must be saved  
for future use - Instructions must be followed

IMPORTANT - Veuillez conserver  
la notice de montage dans le cadre  
d'une prochaine utilisation.  
Parcourir cette notice avec attention

1

