

Sanchez

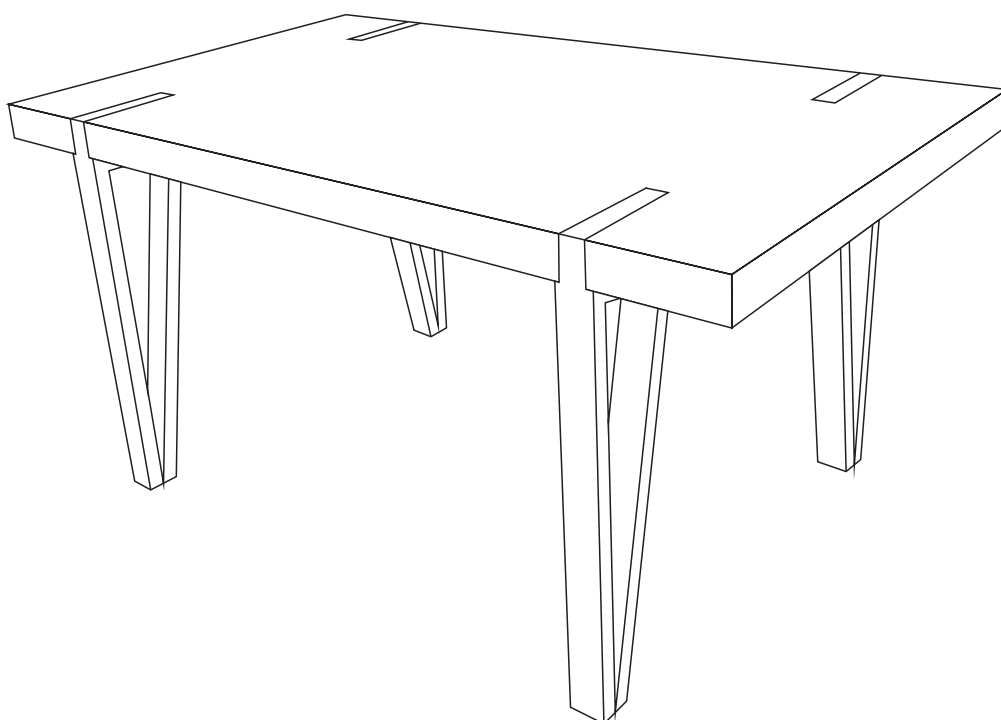

(D) Montageanleitung
(FR) Notice de montage
(NL) Handleiding voor de montage
(CZ) Montážní návod
(HU) Szerelési útmutató
(TR) Montaj talimatı

(GB) Assembly Instructions
(IT) Istruzioni di montaggio
(PL) Instrukcja montażu
(SK) Návod na montáž
(RO) Instrucțiunile de montaj
(RU) ИНСТРУКЦИЯ ПО МОНТАЖУ

**Service • Assistenza • Dienstverlening • Serwis
Servis • Szerviz • Сервисная служба**

Name • Nom • Nome • Naam •
Nazwa • Jméno • Název • Név •
Департамент • Isim • Название

Nr. • No. • N° • Номер • Č • Sz

Typ • Type • Tip • Típus • Тип •
Típi

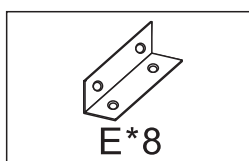
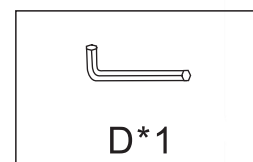
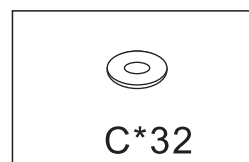
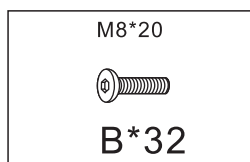
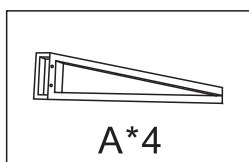
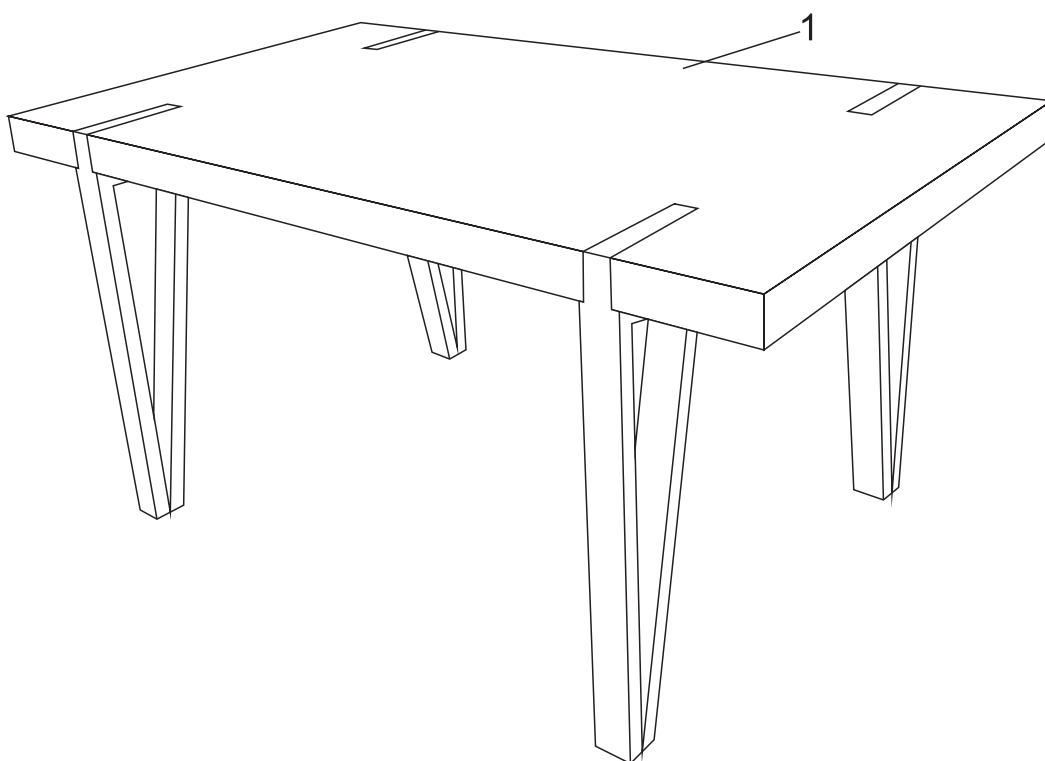
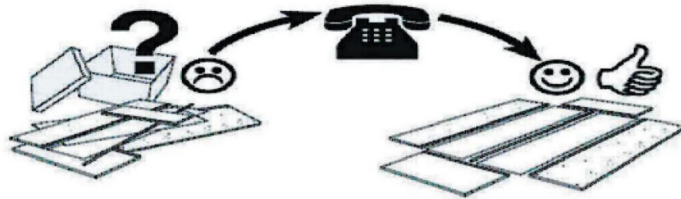
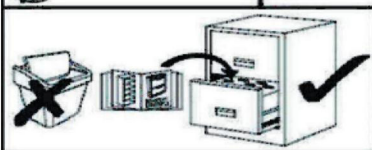

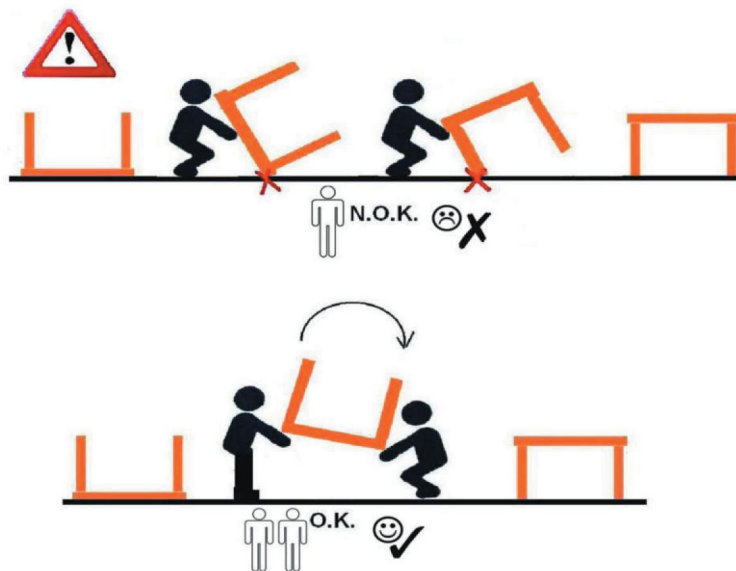
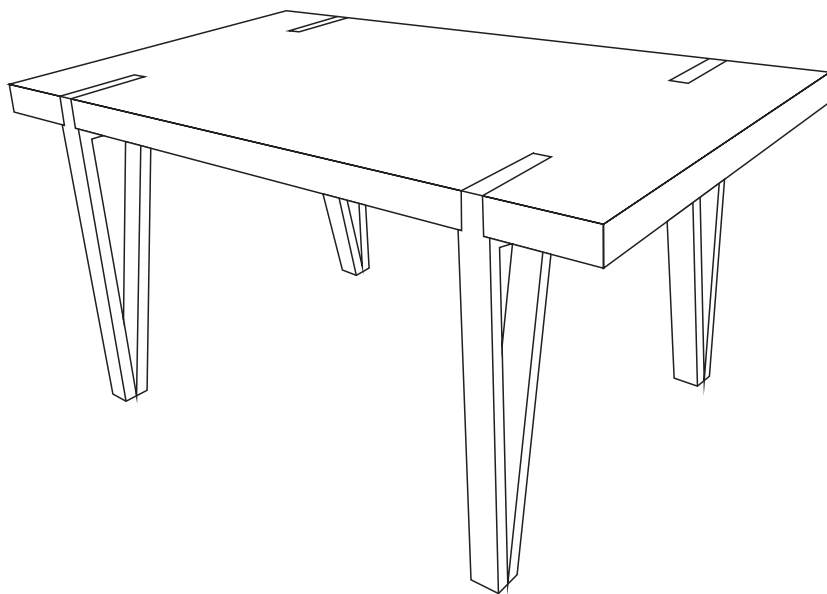
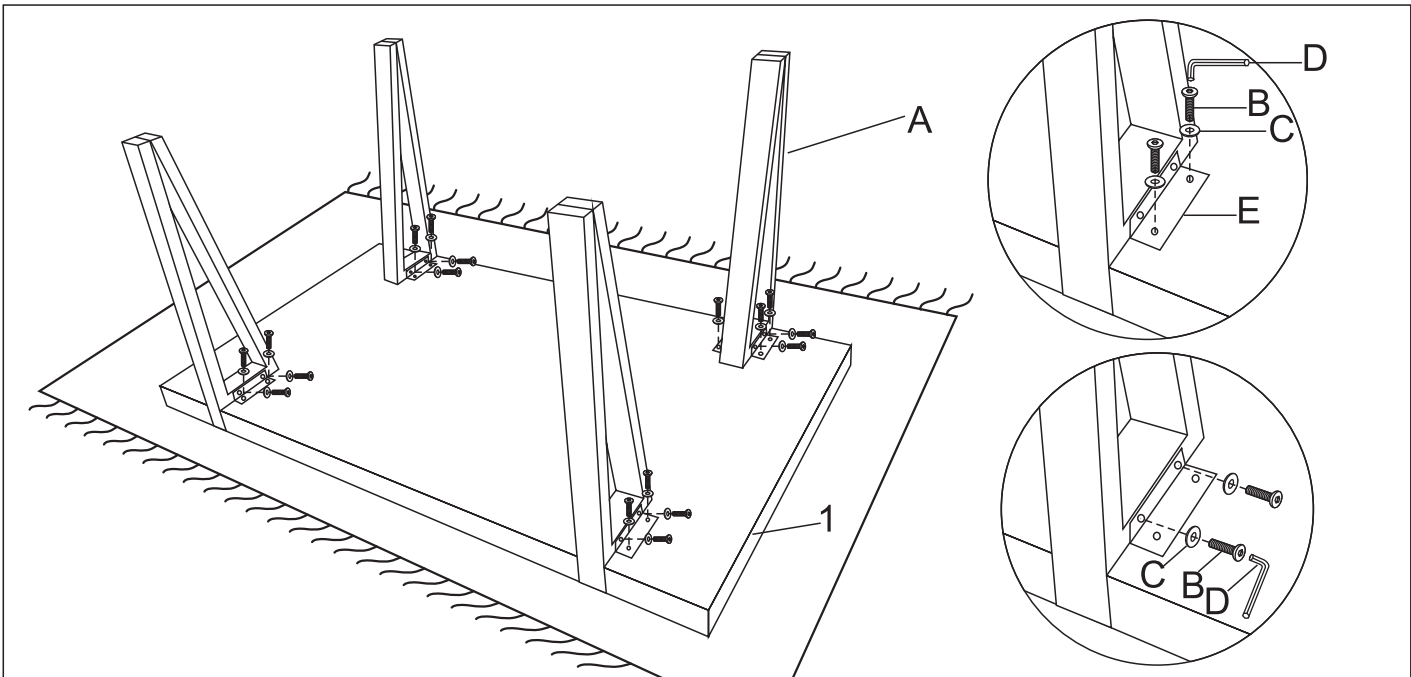

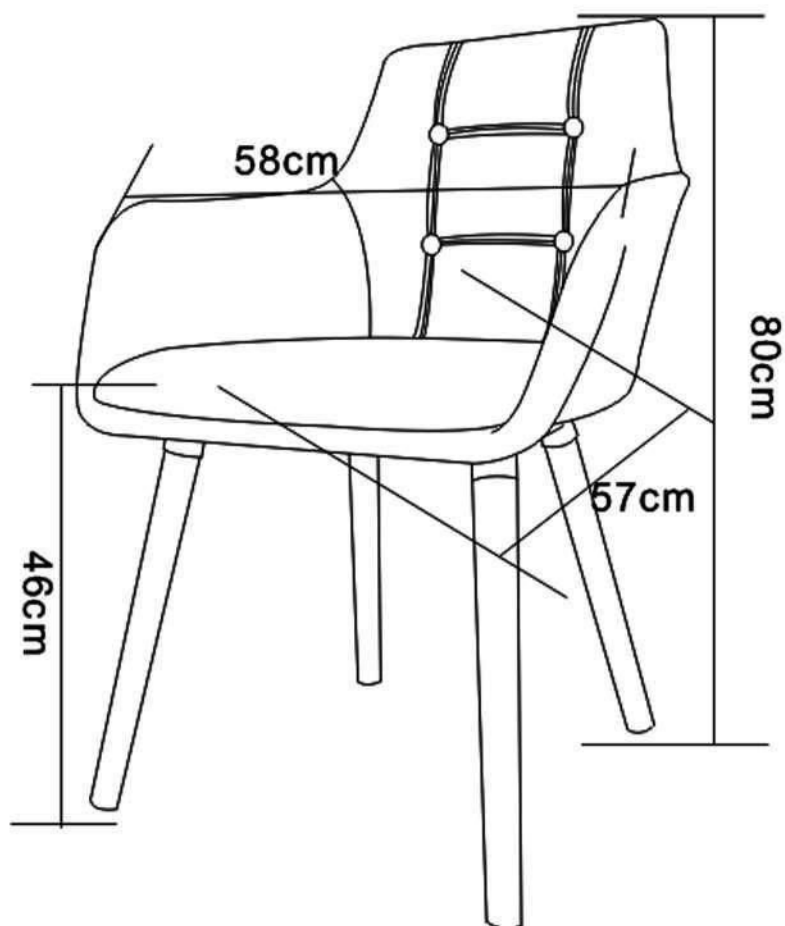

(D) Montageanleitung

(FR) Notice de montage

(NL) Handleiding voor de montage

(CZ) Montážní návod

(HU) Szerelési útmutató

(TR) Montaj talimatı

(GB) Assembly Instructions

(IT) Istruzioni di montaggio

(PL) Instrukcja montaży

(SK) Návod na montáž



(RO) Instrucțiuni de montaj

(RU) инструкция по монтажу

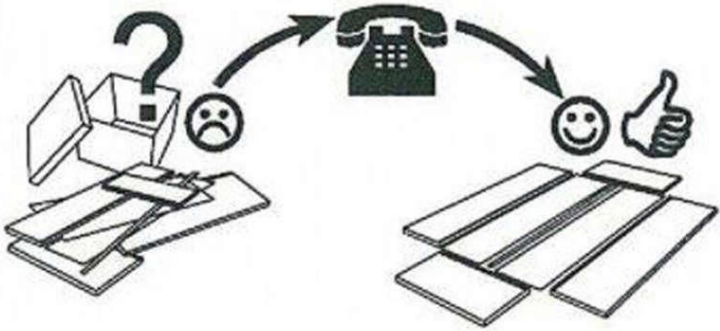

30min

Service•Dienstverlening•Serwis•Servis•Сервисная служба

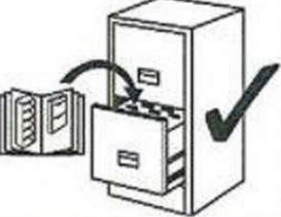
Name • Назв • Nazwa • Isim • Название _____ Nr. • No. • Номер _____ Тур • Туре • Тір • Тип _____ 	
 	
_____ _____ _____	
_____ _____ _____	

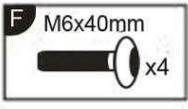
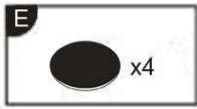
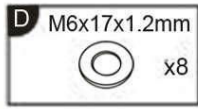
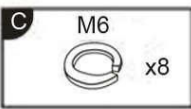
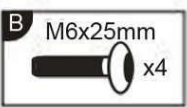
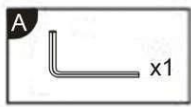
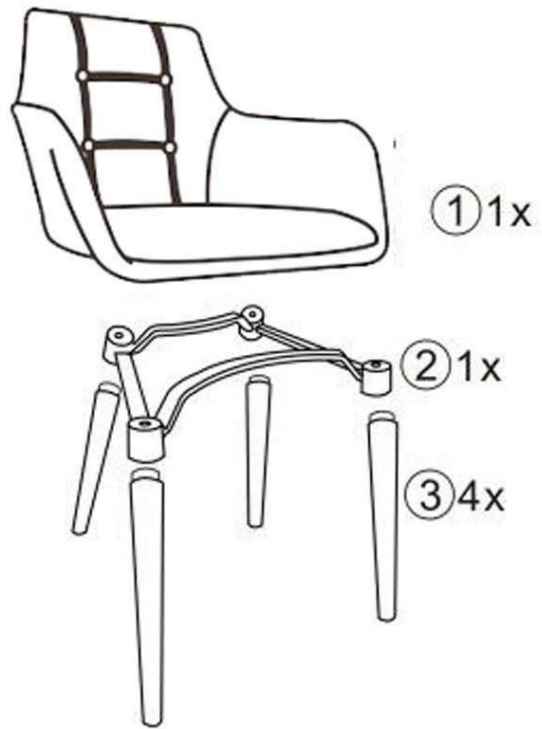

1

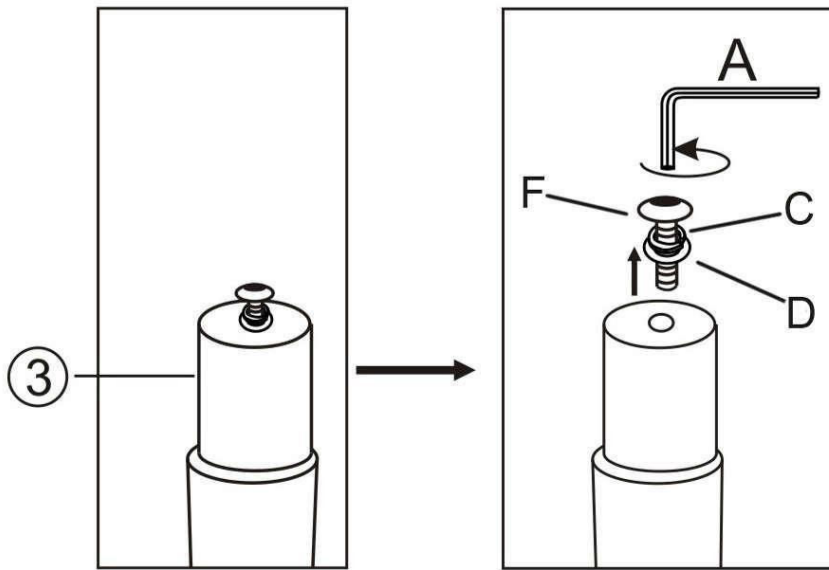

2

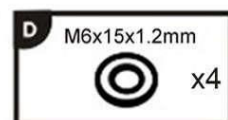
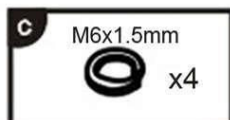
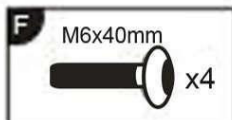
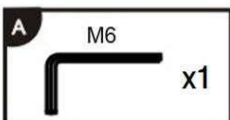
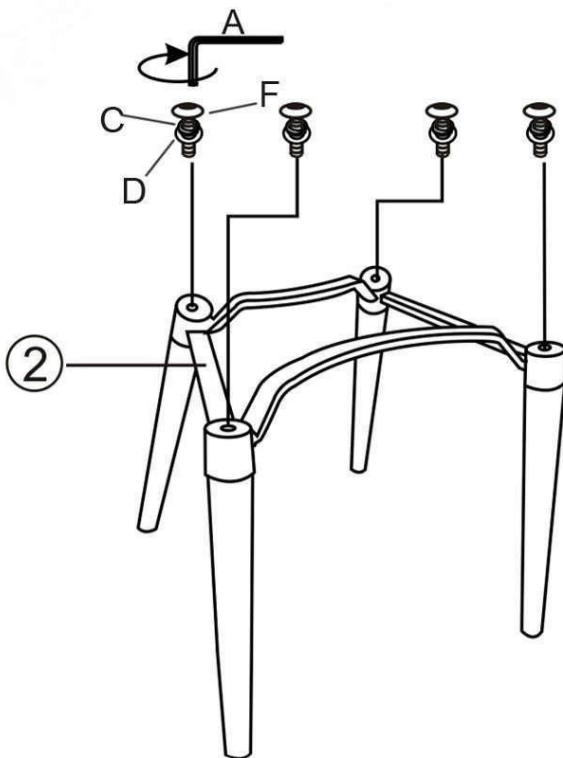

3

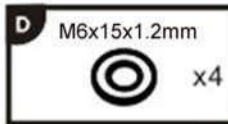
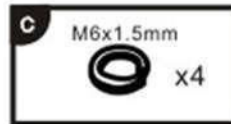
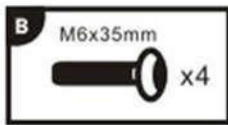
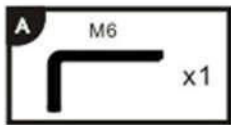
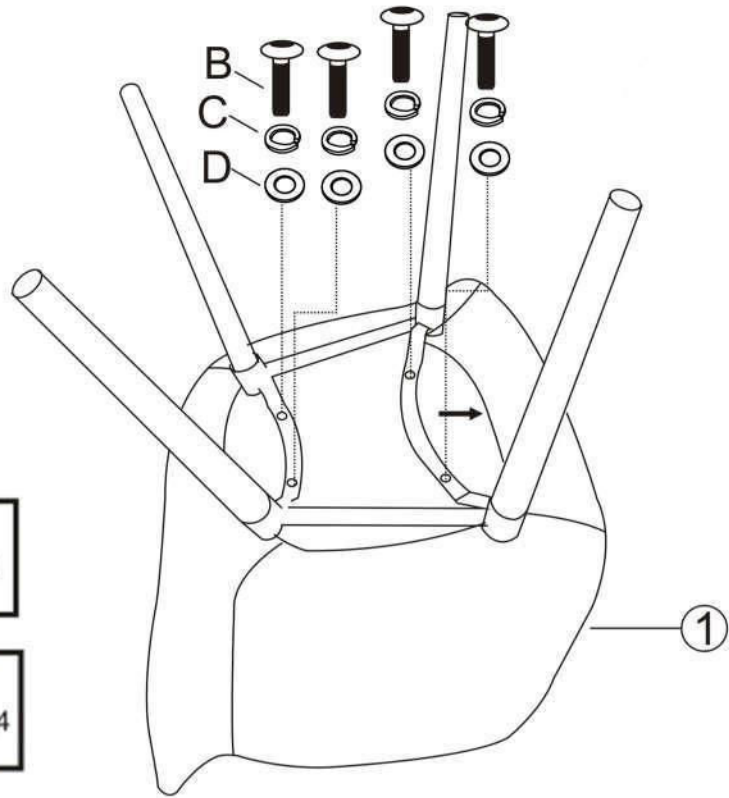

4

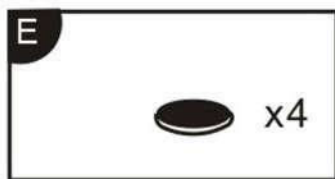

5

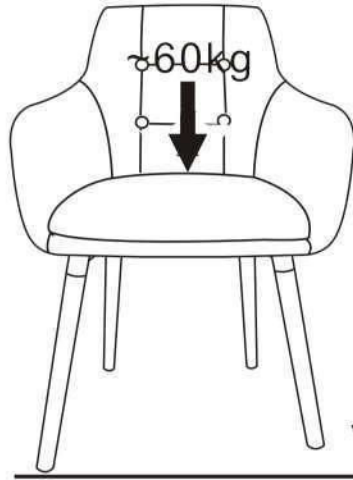

6



D	Ziehen Sie alle Schrauben sowie tragende Verbindungsteile nach ca. 5 Wochen nach, um eine dauerhafte Standsicherheit zu gewährleisten.
GB	After approx. 5 weeks, tighten all screws and load-bearing connecting parts to ensure permanent stability.
FR	Resserrez toutes les vis ainsi que les pièces de fixation au bout d'environ 5 semaines pour garantir une sécurité de fixation durable.
IT	Ristringere tutte le viti e giunture dopo ca. 5 settimane, al fine di garantire una durevole solidità.
NL	Draai alle schroeven en ook dragende verbindingstukken na ca. 5 weken nog eens vast, zodat een continue stabiliteit wordt gegarandeerd.
PL	Prosimy po ok. 5 tygodniach dokręcić wszystkie śruby w elementach łączeniowych. Zagwarantuje to Państwu trwałość i stabilność połączeń.
CZ	Dotáhněte všechny šrouby a nosné spojovací díly přibližně po 5 týdnech, aby se zaručila trvalá stabilita.
SK	Po cca 4 týždňoch dotiahnite skrutky, aby bola zaručená ich trvalá stabilita.
HU	Húzza utána – kb. 5 hét múlva – az összes csavart és a teherhordó összekötő-alkatrészeket a biztonság érdekében.
RO	Penru a asigura o stabilitate de durată, străngeți după cca. 5 săptămâni toate șuruburile, precum și toate elementele portante de legătură.
TR	Tüm vida ve taşıyıcı bağlantı parçalarını kalıcı bir duruş güvenliğini sağlamak için yaklaşık 5 hafta sonra tekrar sıkınız.
RU	Подкрутите все болты, а также несущие соединительные детали припл. через 5 недель для обеспечения устойчивости в течение длительного времени.
D	Bitte nur mit einem Staubtuch oder leicht feuchtem Lappen reinigen. Keine scheuernden Putzmittel verwenden.
GB	Please only clean with a duster or a damp cloth. Do not use any abrasive cleaners.
FR	Veillez nettoyer uniquement avec un chiffon à poussière ou un chiffon légèrement humide. Ne pas utiliser de détergent abrasif.
IT	Si raccomanda di pulire sono con un panno per la polvere o uno strofinaccio umido. Non utilizzare detersivi abrasivi.
NL	Reinig alleen met een stofdoek of een lichtjes vochtige doek. Gebruik geen schurende poetsmiddelen.
PL	Czyszczenie należy wykonać wyłącznie za pomocą ściereczki lub lekko nawilżonego ręcznika. Nie stosować środków czyszczących do szorowania.
CZ	Čistěte prosím jen prachovkou nebo lehce navlhčeným hadrem. Nepoužívejte drhnoucí čistící prostředky.
SK	Na čistenie používajte len prachovku alebo zľahka navlhčenú utierku. Nepoužívajte žiadne drhnúce čistiacie prostriedky.
HU	Kérjük, csak portórlő kendővel vagy enyhén nedves ronggyal tisztítsa. Ne használjon dörzshatású tisztítószert.
RO	Vă rugăm să utilizați la curățare exclusiv o cârpă de șters praful sau o cârpă ușor umezită. Nu utilizați substanțe de curățat abrazive.
TR	Lütfen sadece bir toz bezıyla veya hafif nemli yumuşak bir bezle siliniz. Aşındırıcı temizlik malzemeleri kullanmayınız.
RU	Очищайте от пыли тряпкой или слегка влажной ветошью. Не допускается применение чистящих средств, не предназначенных для ухода за мебелью.
D	Der Austausch der Gasdruckfeder bzw. die Arbeit daran darf nur durch eingewiesenes Fachpersonal erfolgen.
GB	Replacing and/or working on the gas shock may only be performed by a trained professional.
FR	Le remplacement des vérins pneumatiques ou les travaux effectués dessus ne pourront être réalisés que par du personnel spécialisé formé.
IT	La sostituzione dei pistoncini o eventuali interventi sui pistoncini possono essere eseguiti solo da personale qualificato addestrato.
NL	De vervanging van de gasdrukveer resp. het werk eraan mag alleen gebeuren door geschoolde vaklui.
PL	Wymiana lub inne prace wykonywane przy amortyzatorach gazowych mogą być przeprowadzane tylko przez przeszkolony personel.
CZ	Výměnu plynových pružin, popř. práci na nich smí provádět jen zaškolení specialisté.
SK	Výmenu pneumatickej pružiny, príp. práce na nej, smie vykonať len vyškolený odborný personál.
HU	A gázrúgót kizárólag képzett szakember cserélheti és javíthatja.

