

SOLVEI
8141/2500/8300
8100/2500/8142

- | | | | |
|-----------|--|-----------|---|
| D | MONTAGEANLEITUNG
BEDIENUNGSANLEITUNG | GB | ASSEMBLY INSTRUCTIONS
INSTRUCTION MANUAL |
| NL | HANDLEIDING VOOR DE MONTAGE
GEBRUIKSAANWIJZING | PL | INSTRUKCJA MONTAŻU
INSTRUKCJA OBSŁUGI |
| TR | MONTAJ TALIMATI
KULLANIM KLAVUZU | RU | ИНСТРУКЦИЯ ПО МОНТАЖУ
ИНСТРУКЦИЯ ПО ЭКСПЛУАТАЦИИ |
| RO | INSTRUCȚIUNI DE INSTALARE
INSTRUCȚIUNI DE UTILIZARE | IT | ISTRUZIONI DI MONTAGGIO
MANUALE DI ISTRUZIONI |
| FR | NOTICE DE MONTAGE
MANUEL INSTRUCTIONS | SK | MONTÁŽNY NÁVOD
NÁVOD NA POUŽITIE |
| HU | KÖZGYŰLÉS UTASÍTÁSOK
KEZELÉSI UTASÍTÁS | CZ | MONTÁŽNÍ NÁVOD
NÁVOD K POUŽITÍ |
| SI | NAVODILA ZA MONTAŽO
NAVODILA ZA UPORABO | PT | INSTRUÇÕES DE MONTAGEM
MANUAL DO USUÁRIO |
| ES | INSTRUCCIONES DE MONTAJE
MANUAL DEL USUARIO | HR | UPUTE ZA MONTAŽU
UPUTE ZA UPOTREBU |

F/B

222401

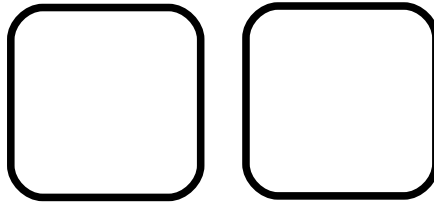

0064

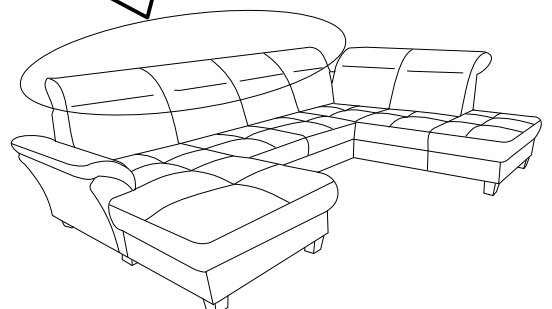
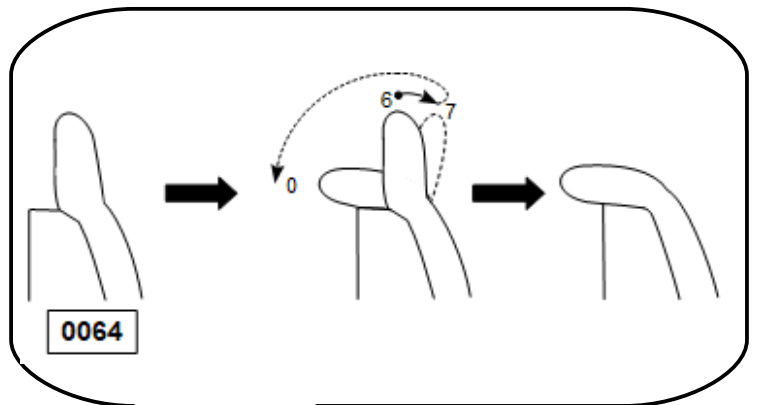
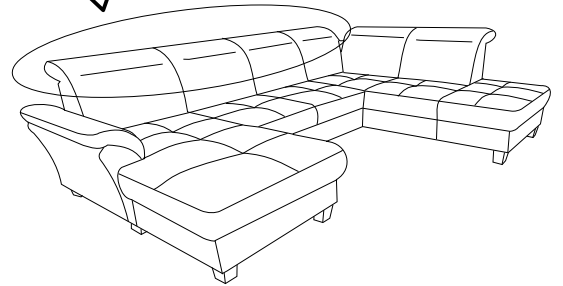
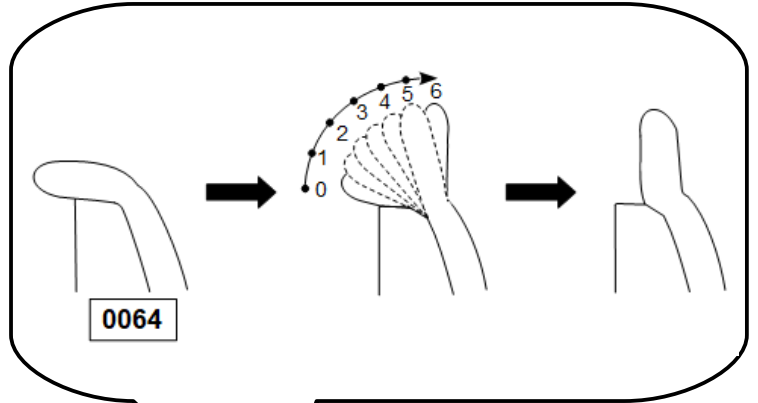
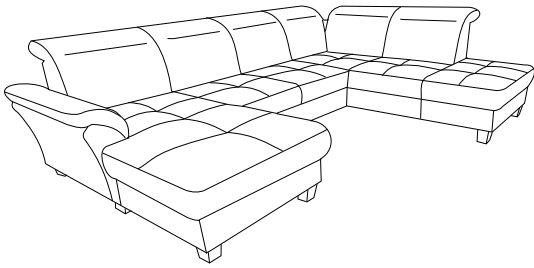

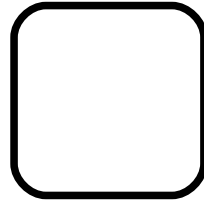
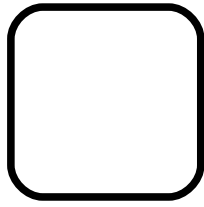

0019

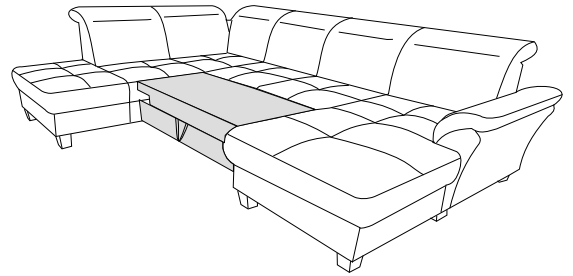
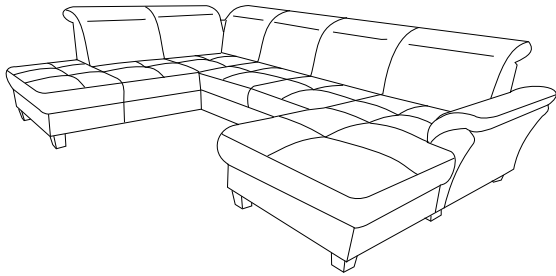

0019

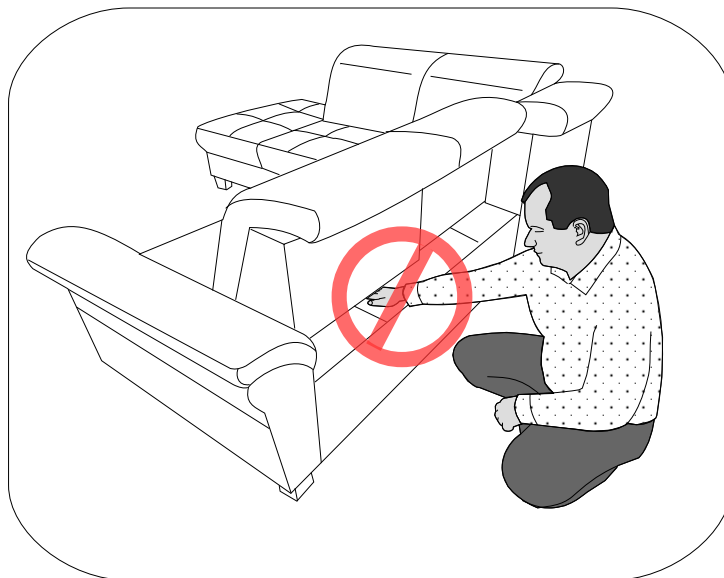



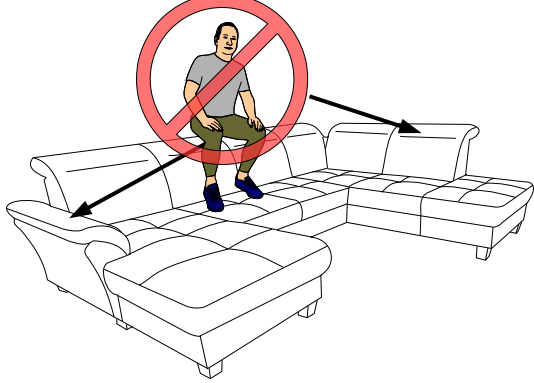

R

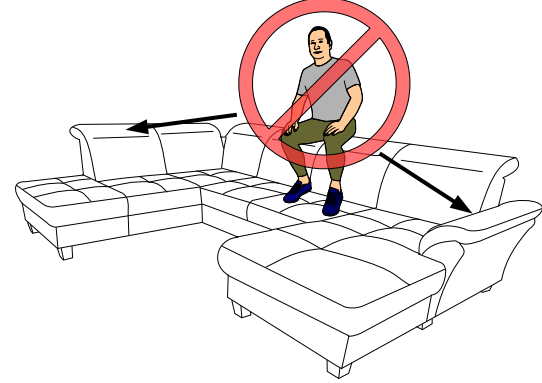





L

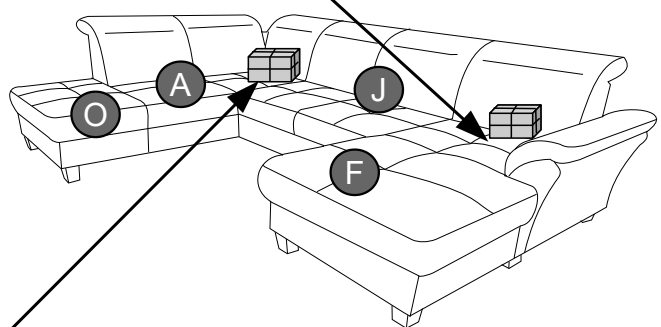
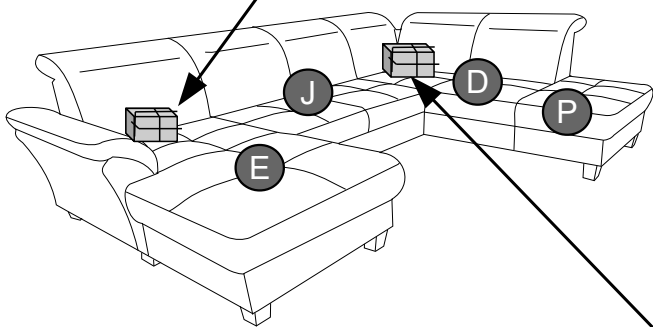





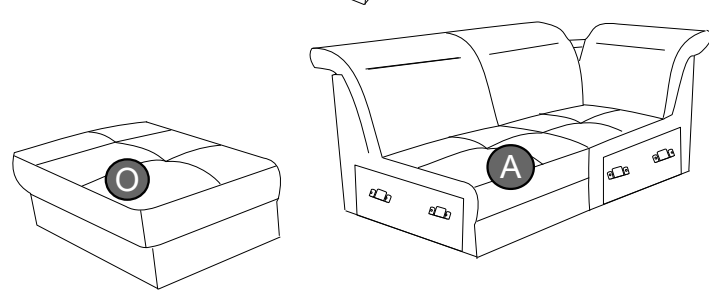
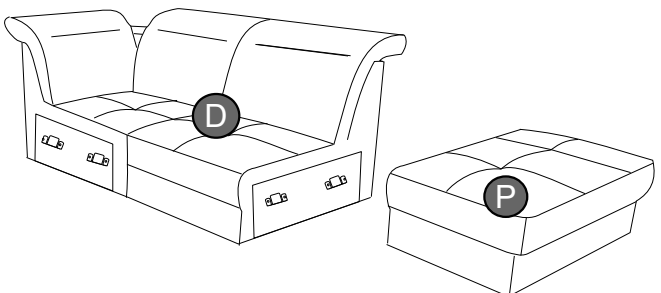
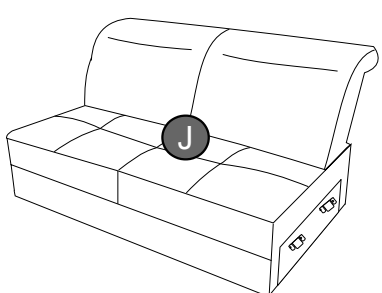
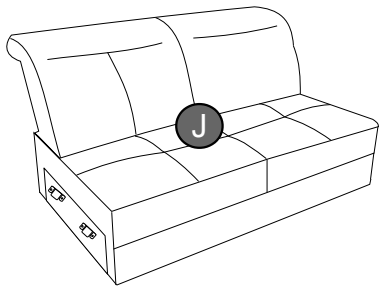
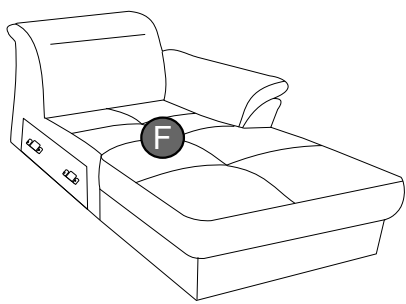
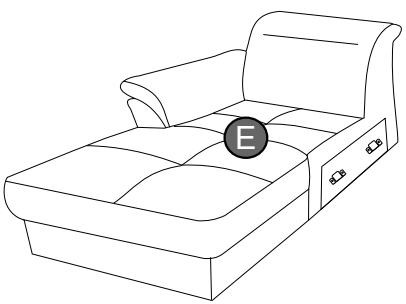

i L-5 	s H-90 	q M8*80 	g H-90 	x Fi-50 	[mm]
X1	X5	X5	X1	X5	

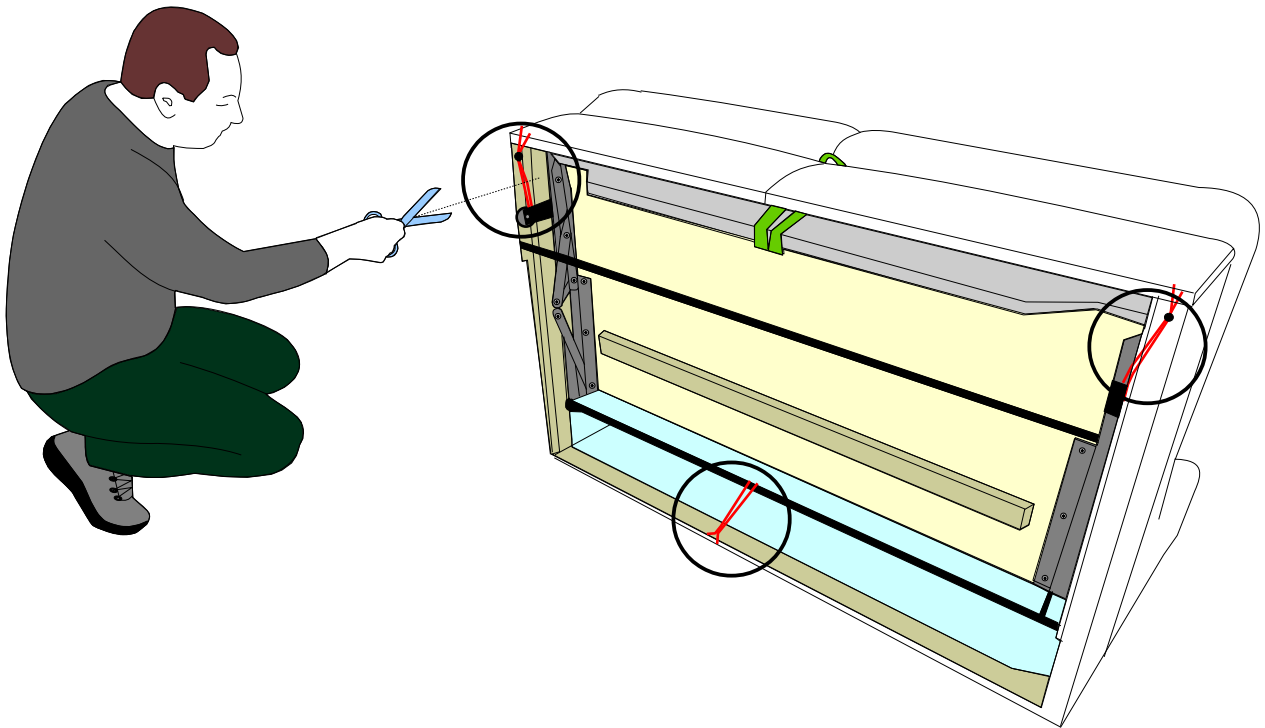
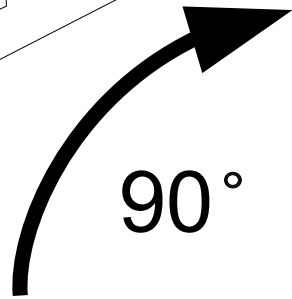
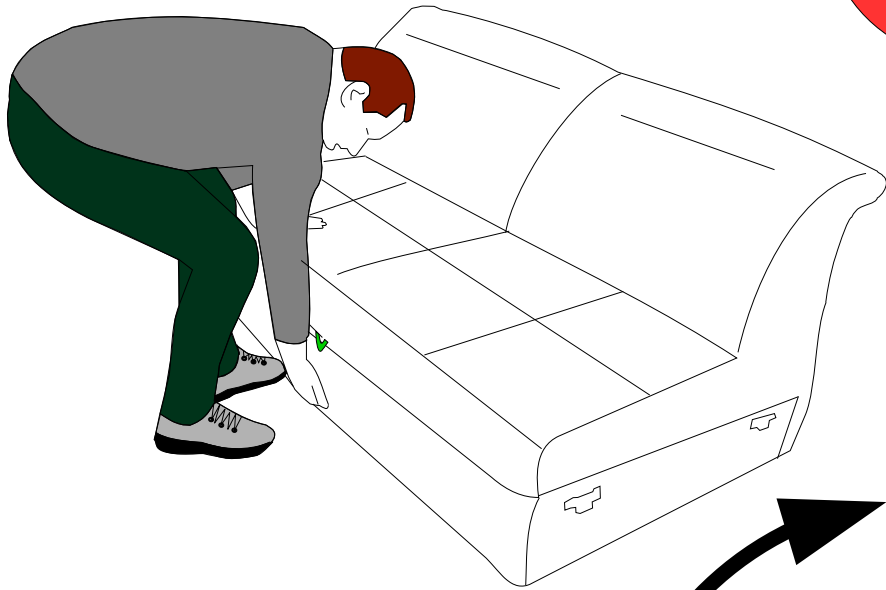







s H-90 	q M8*80 	i L-5 	g H-90 	x Fi-50 
X4	X4	X1	X3	X4

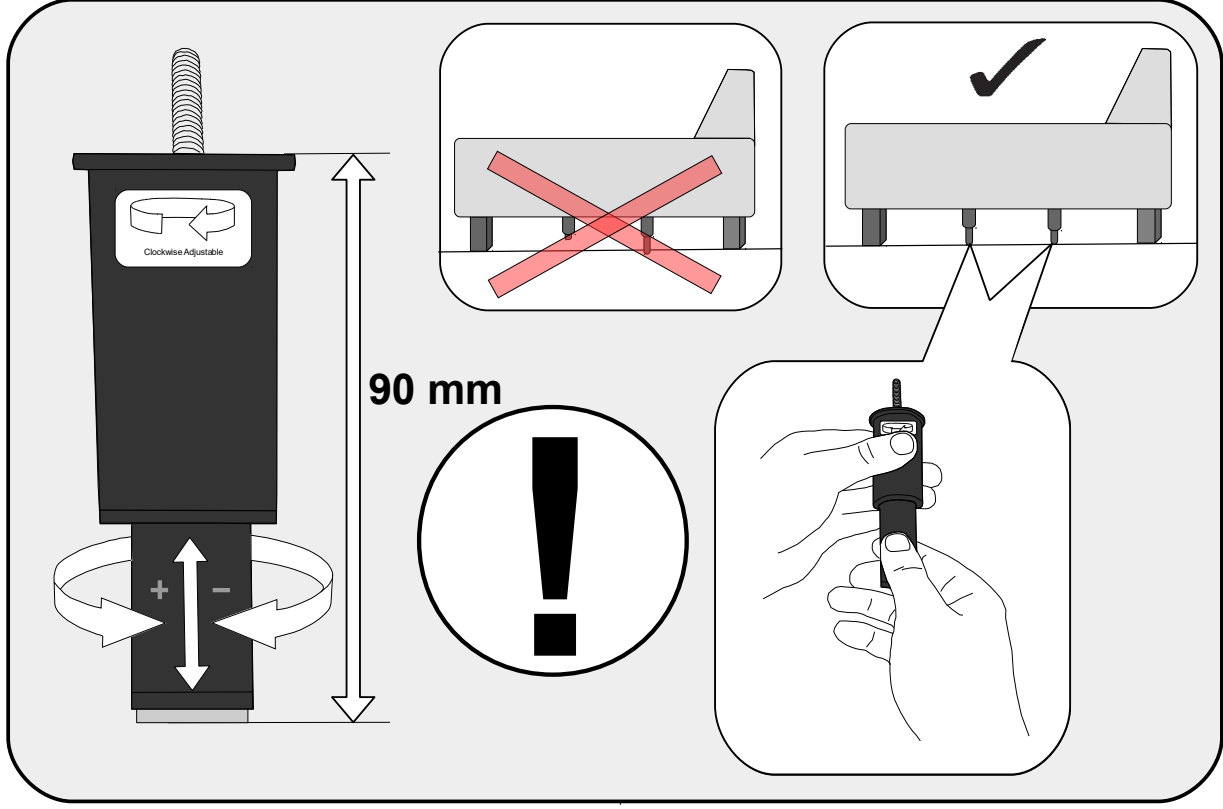
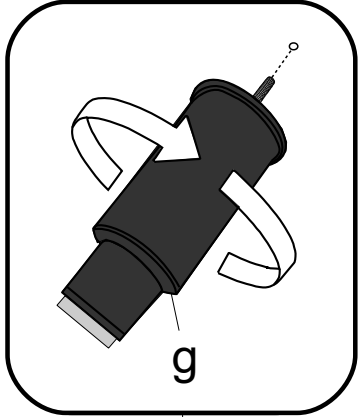
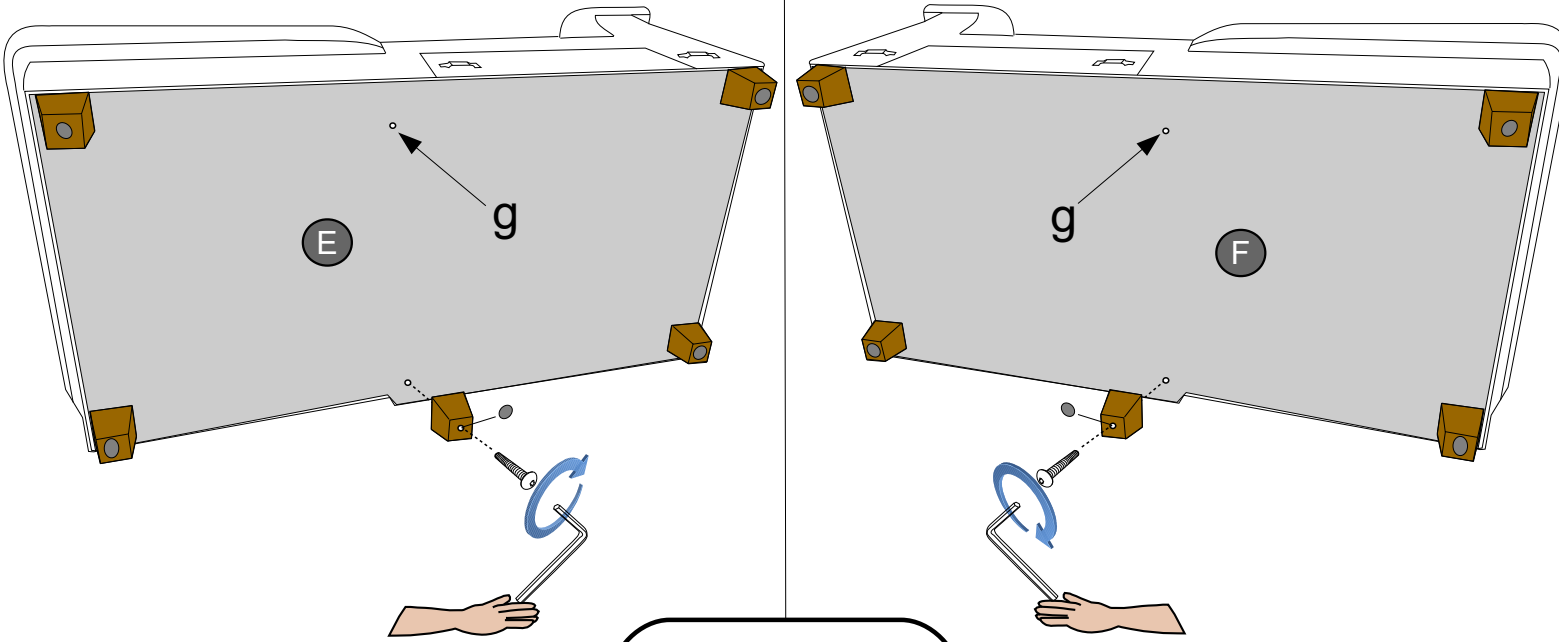







i L-5	s H-90	q M8*80	g H-90	x Fi-50
				
X1	X5	X5	X1	X5

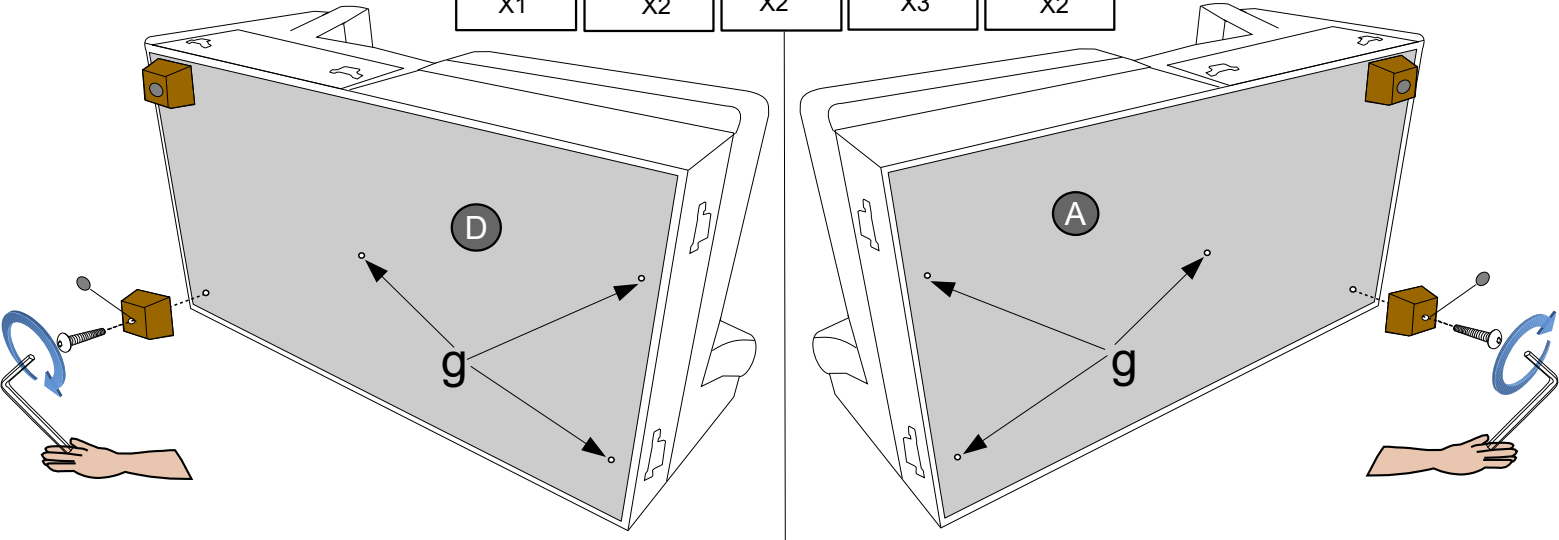

i L-5	s H-90	q M8*80	g H-90	x Fi-50
				
X1	X2	X2	X3	X2



i L-5	s H-90	q M8*80	x Fi-50
			
X1	X2	X2	X2

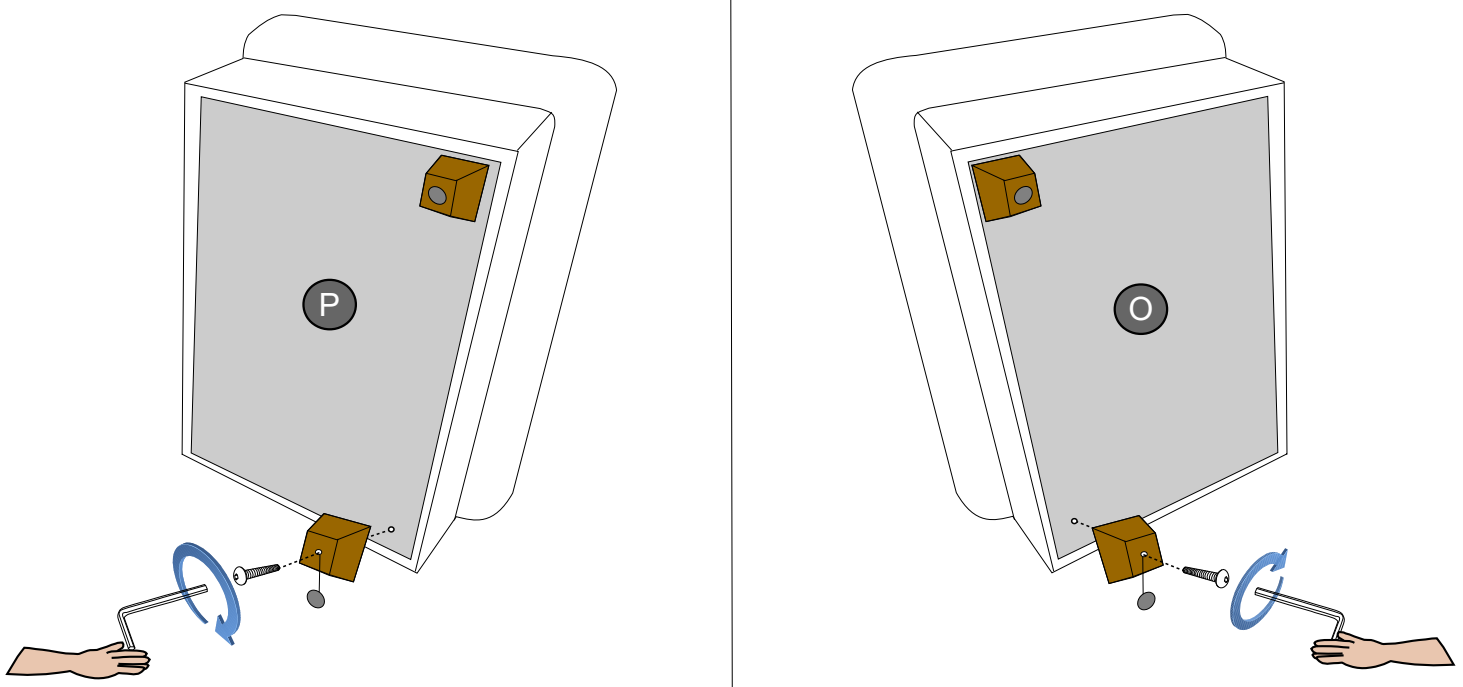

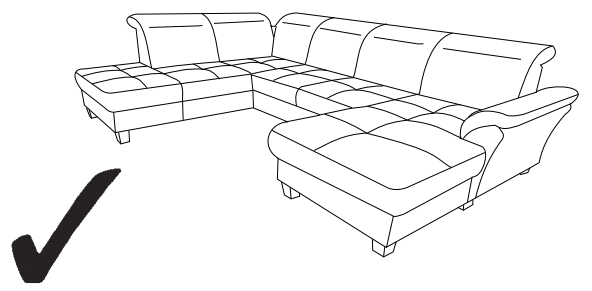
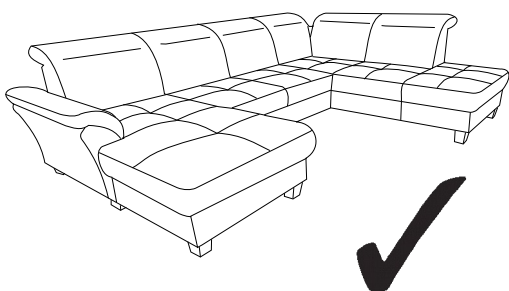
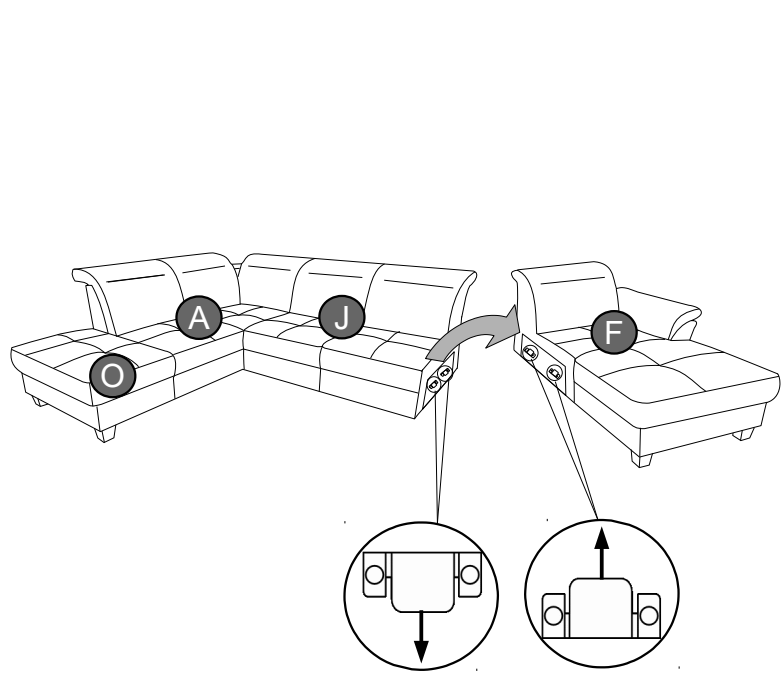
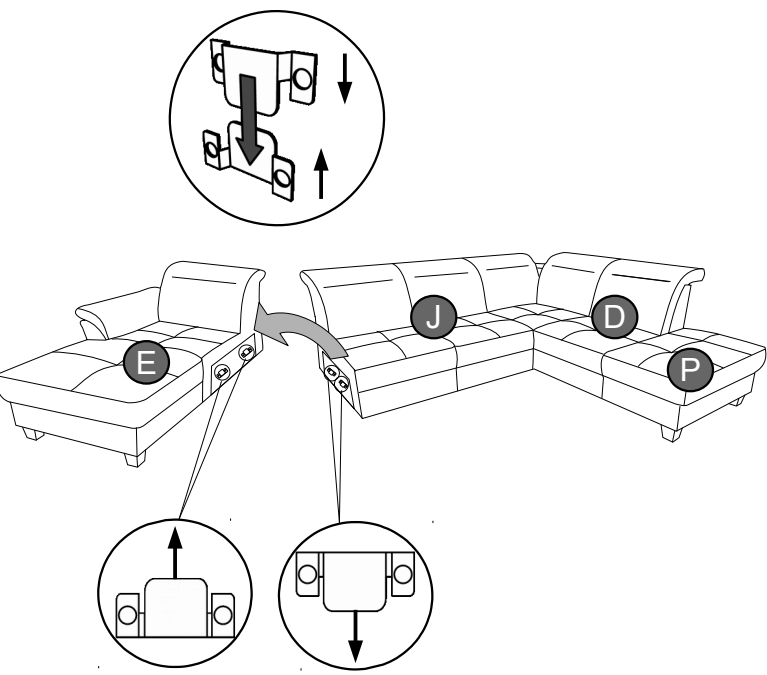
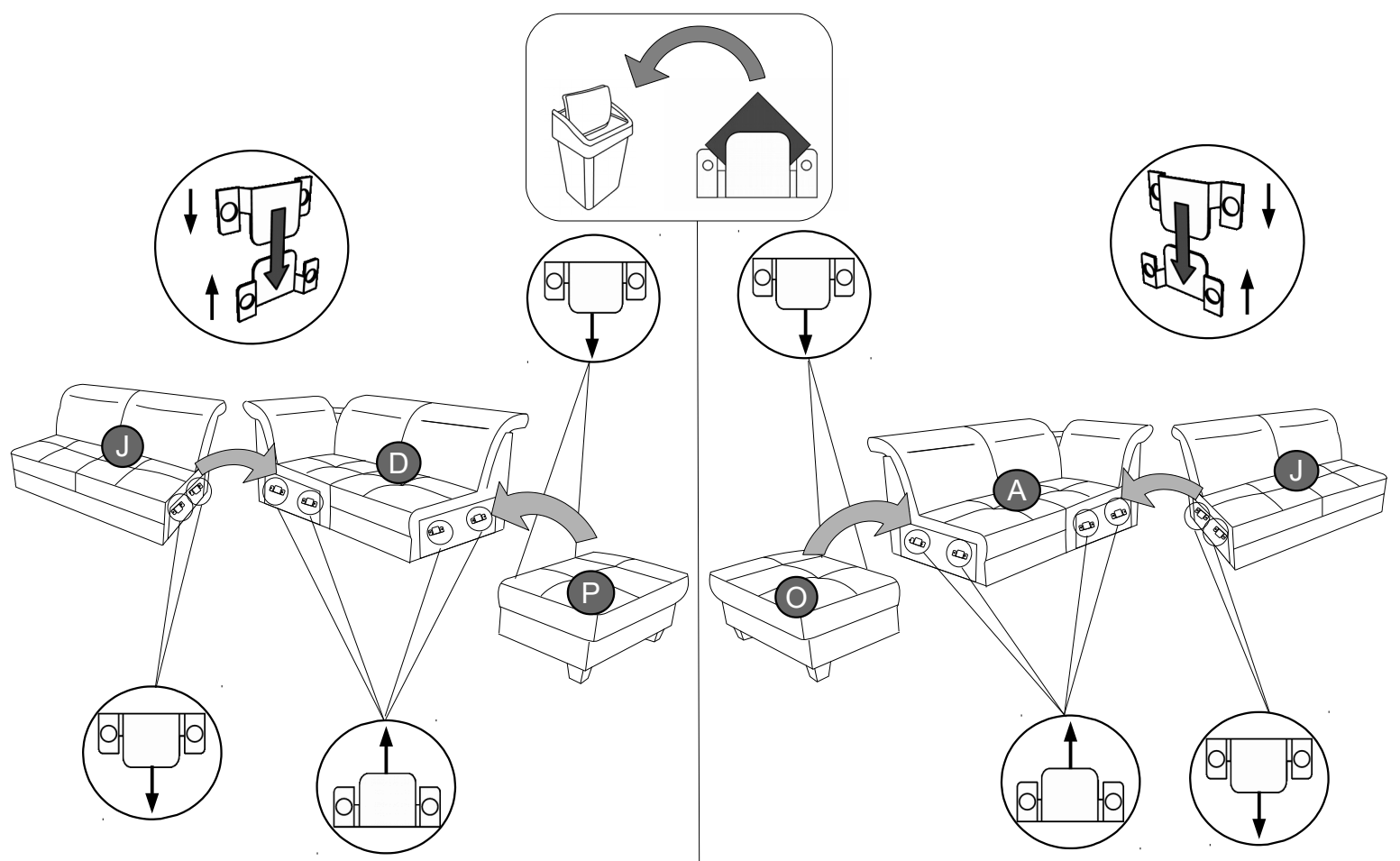

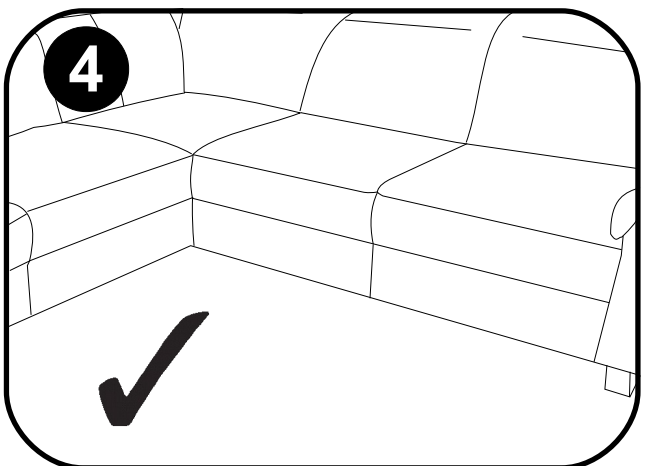
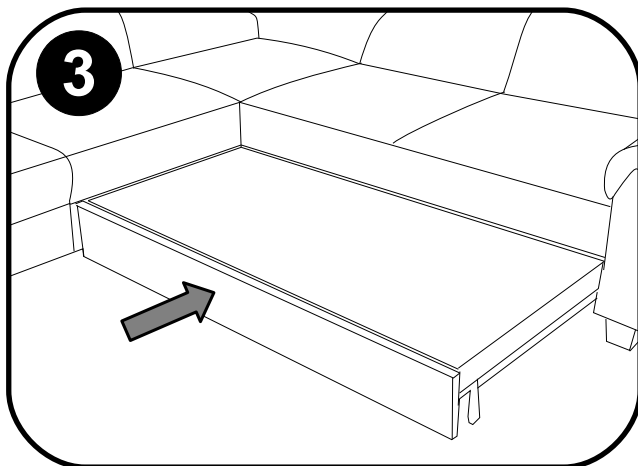
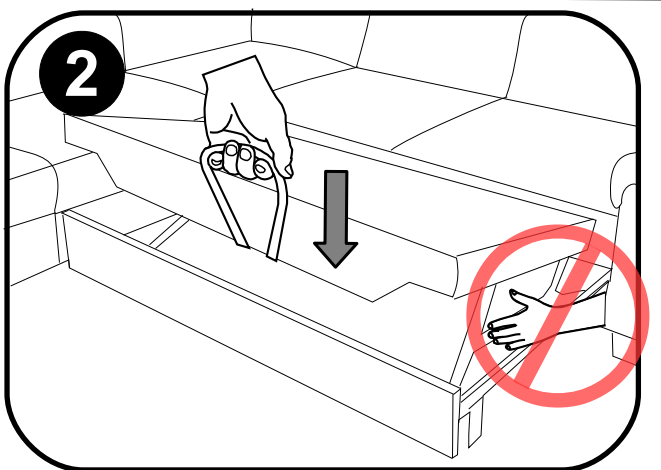
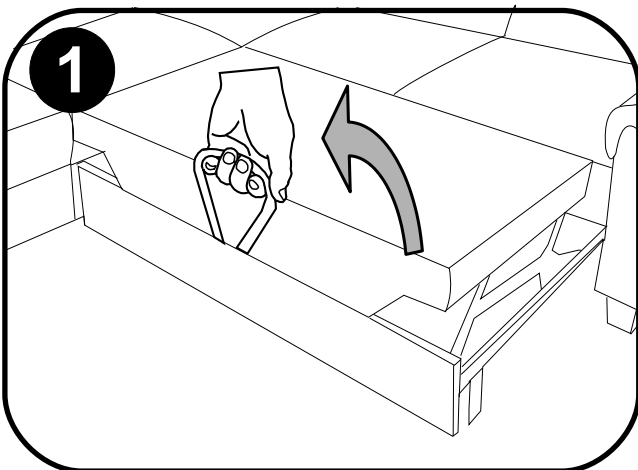
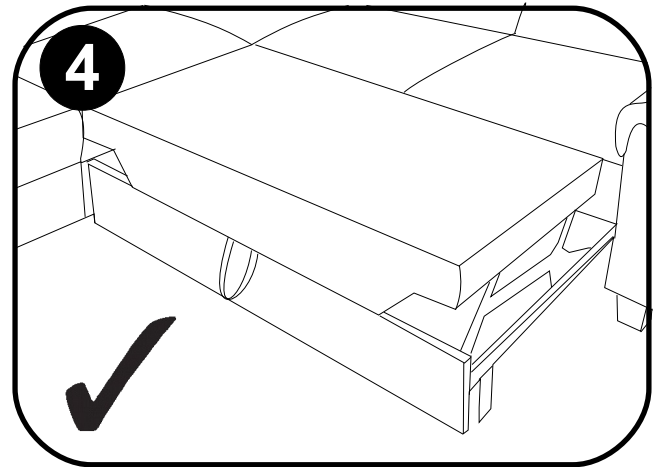
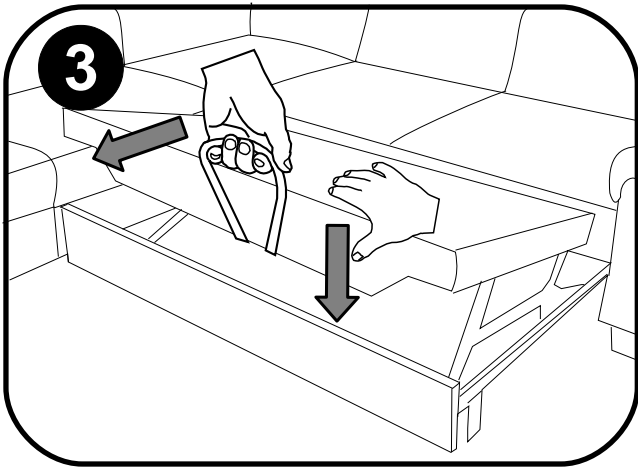
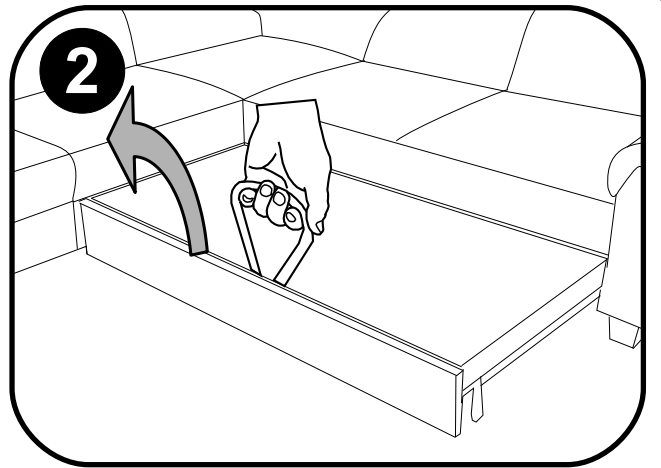
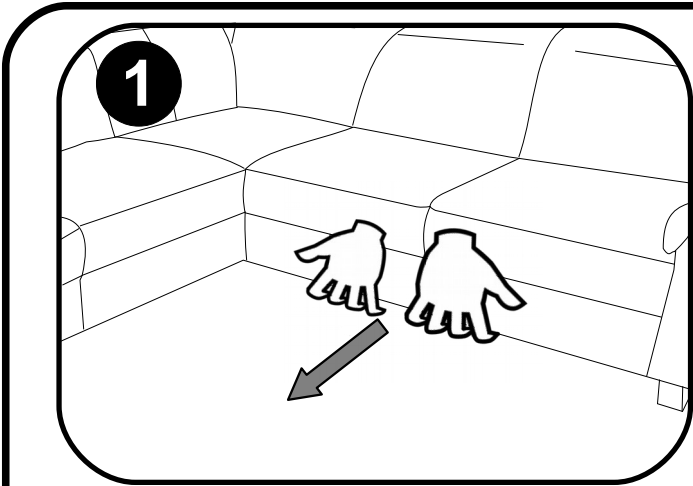
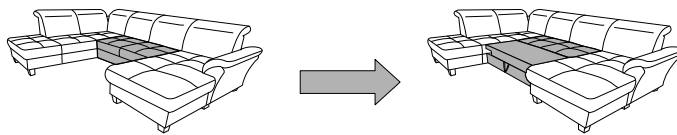

Name · Naam · Nazwa · İsim · Название · Nume · Nome · Názov · Názov ·
 Název · Neve

SOLVEI

Typ · Type · Tip · Тип · Tipo · Típus

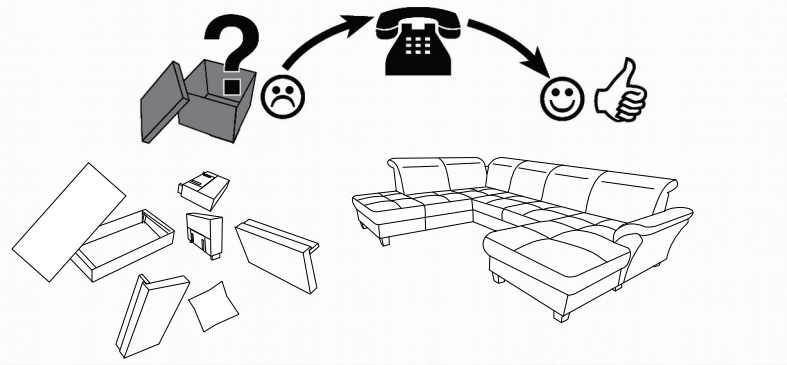
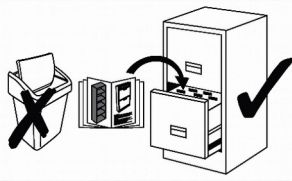
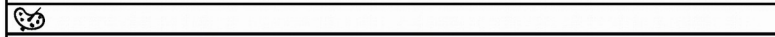

R

L

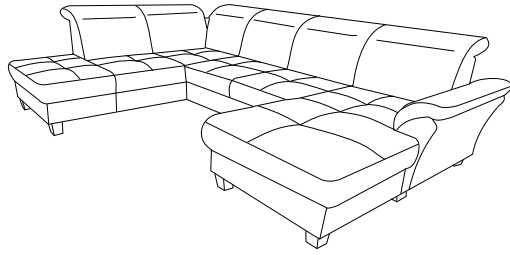
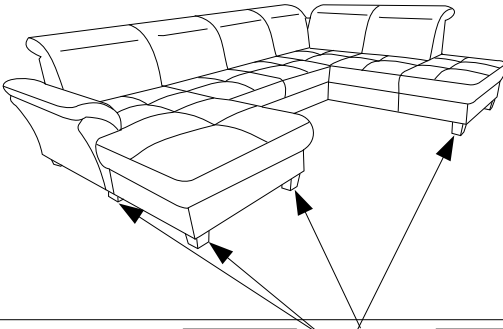

i L-5	s H-90	q M8*80	g H-90	x Fi-50 [mm]

