

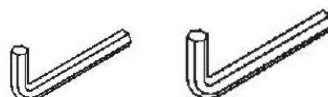

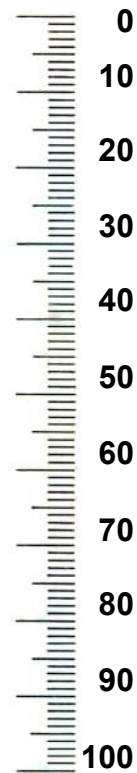

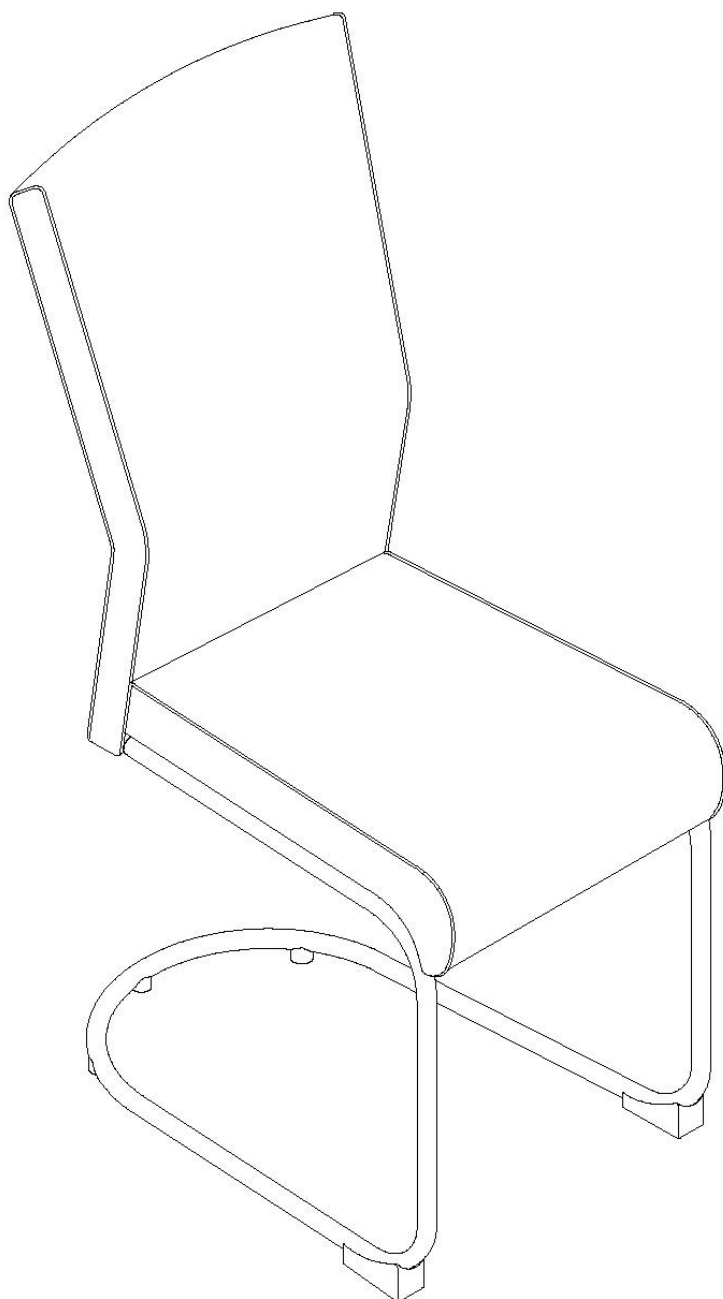





Typ: Nr. 086-8607

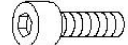

 76*26	 Ø25	 M6*15	 M8*20	 Ø5*16
Ax2	Bx3	Cx4	Dx4	Ex4
 Ø16	 Ø20	 Ø8.5	 4#	 6#
Fx4	Gx4	Hx4	Ix1	Jx1

