

ARNGAST
3100-8300
8100-3300
2019-10/01

D MONTAGEANLEITUNG
BEDIENUNGSANLEITUNG

NL HANDLEIDING VOOR DE MONTAGE
GEBRUIKSAANWIJZING

TR MONTAJ TALIMATI
KULLANIM KLAVUZU

RO INSTRUCȚIUNI DE INSTALARE
INSTRUCȚIUNI DE UTILIZARE

FR NOTICE DE MONTAGE
MANUEL INSTRUCTIONS

HU KÖZGYŰLÉS UTASÍTÁSOK
KEZELÉSI UTASÍTÁS

SI NAVODILA ZA MONTAŽO
NAVODILA ZA UPORABO

ES INSTRUCCIONES DE MONTAJE
MANUAL DEL USUARIO

GB ASSEMBLY INSTRUCTIONS
INSTRUCTION MANUAL

PL INSTRUKCJA MONTAŻU
INSTRUKCJA OBSŁUGI

RU ИНСТРУКЦИЯ ПО МОНТАЖУ
ИНСТРУКЦИЯ ПО ЭКСПЛУАТАЦИИ

IT ISTRUZIONI DI MONTAGGIO
MANUALE DI ISTRUZIONI

SK MONTÁŽNY NÁVOD
NÁVOD NA POUŽITIE

CZ MONTÁŽNÍ NÁVOD
NÁVOD K POUŽITÍ

PT INSTRUÇÕES DE MONTAGEM
MANUAL DO USUÁRIO

HR UPUTE ZA MONTAŽU
UPUTE ZA UPOTREBU

Name · Naam · Nazwa · Ísim · Название · Nume · Nome · Názov · Názov ·
Název · Neve

ARNGAST

Typ · Type · Tip · Тип · Tipo · Típus

3100-8300; 8100+-3300

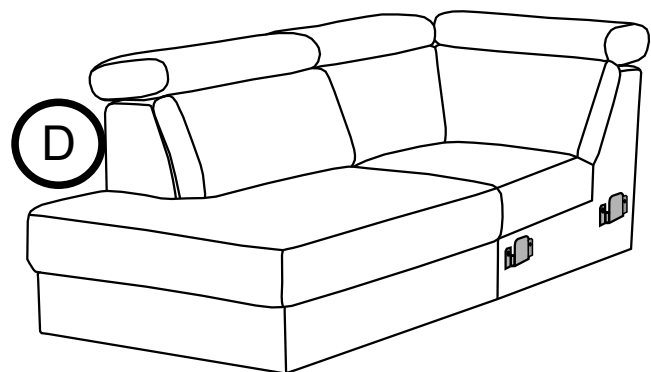
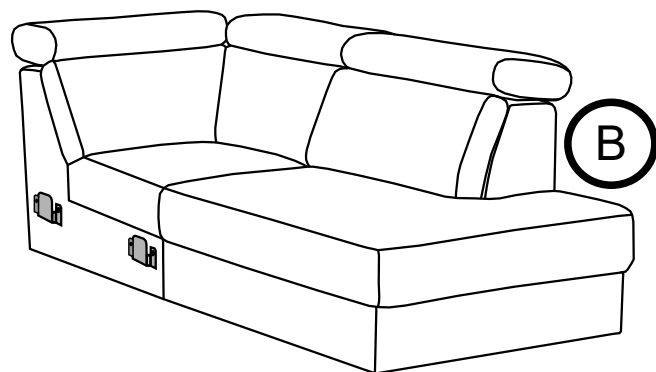
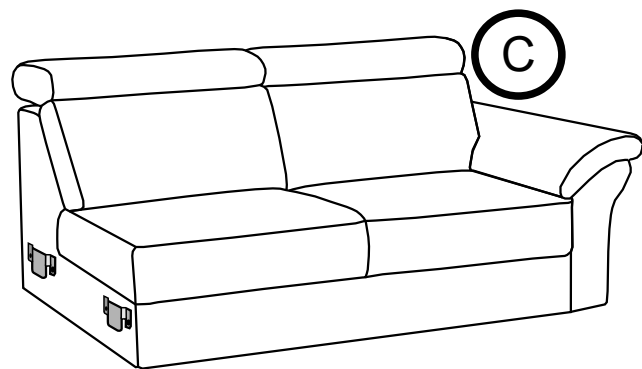
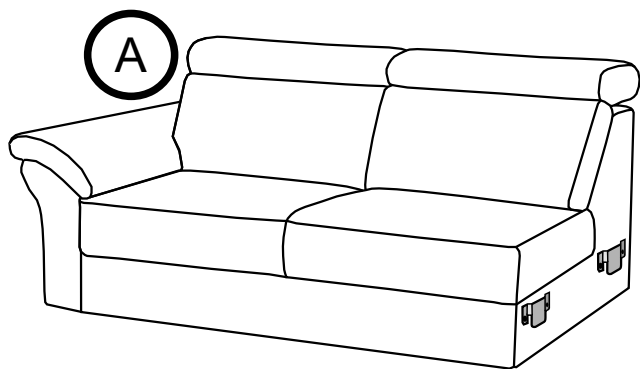
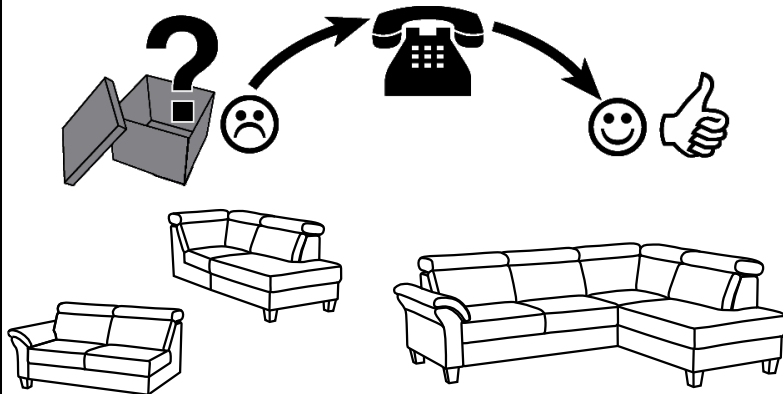
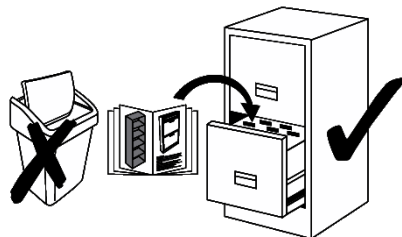

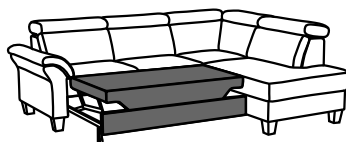

8
0019

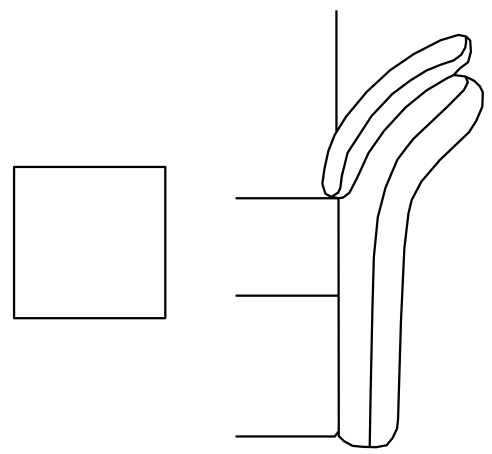
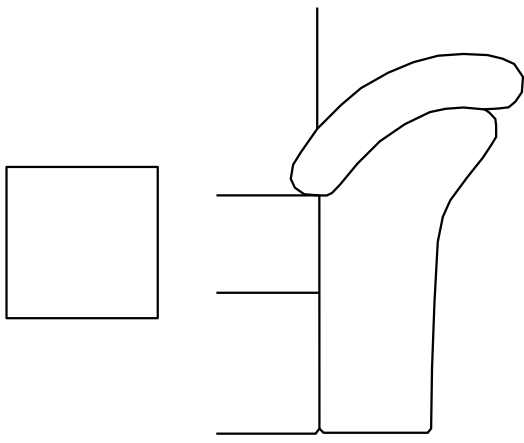



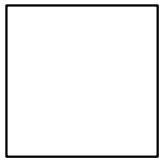

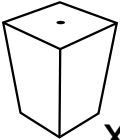
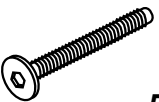
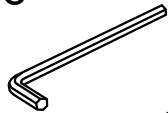
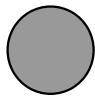

v1

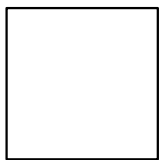

a	b M8x110	c	d	e	f
 x5	 x5	 x1	 x6	 x1	 x1

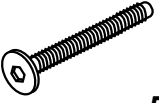
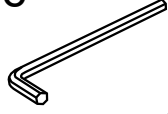
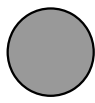

v2



a	b M8x110	c	d	e	f
 x5	 x5	 x1	 x6	 x1	 x1

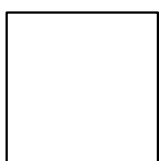

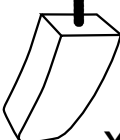
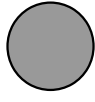
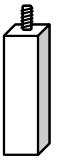

v3

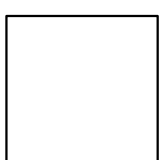

a	d	e	f	g
 x5	 x6	 x1	 x1	 x6

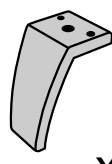

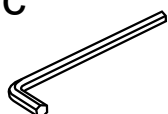
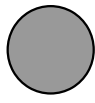
v4



a	b M8x20	c	d	e	f
 x5 a1  x5	 x5	 x1	 x1	 x1	 x1

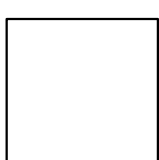

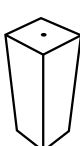
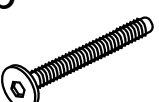
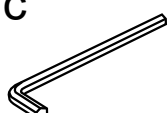
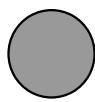
v5



a	b M8x110	c	d	e	f
 x5	 x5	 x1	 x6	 x1	 x1

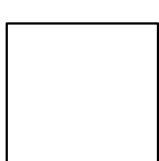

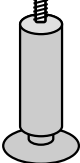
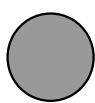
v6

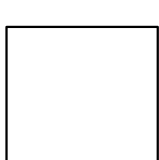

a	d	e	f
 x5	 x6	 x1	 x1

v7

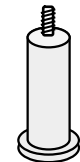
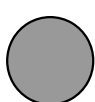

a	d	e	f
 x5	 x6	 x1	 x1

v1 v2 v5

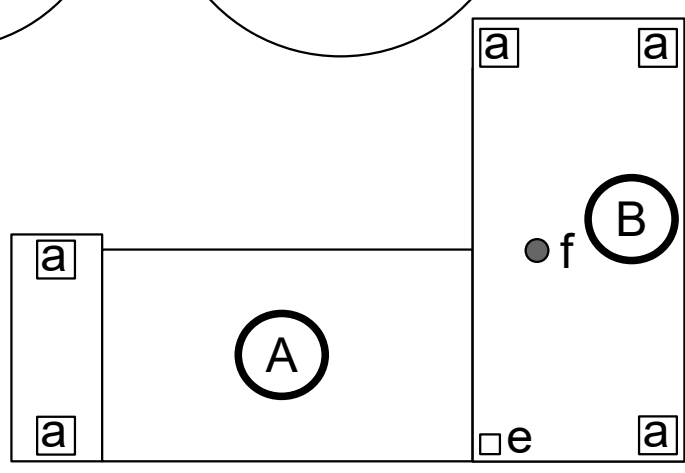
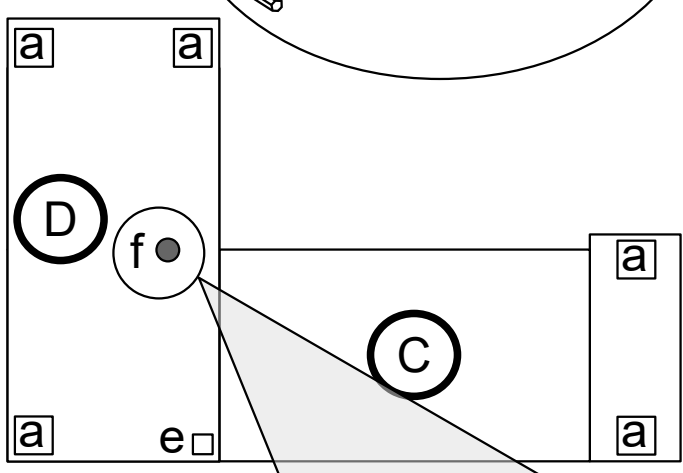
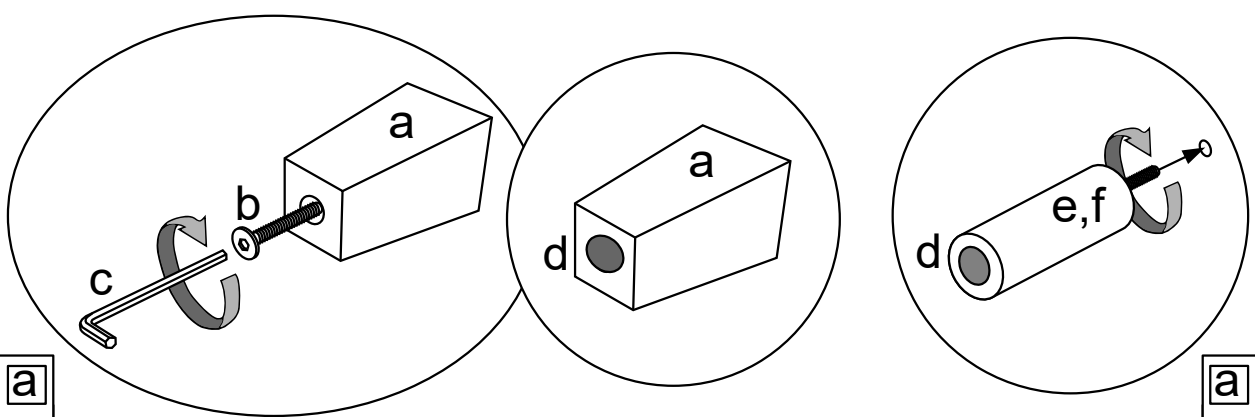
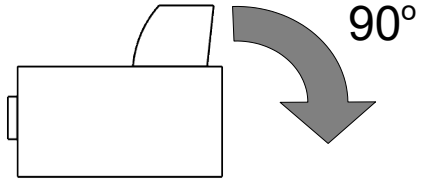

f, 120mm, X, ✓, !

v3

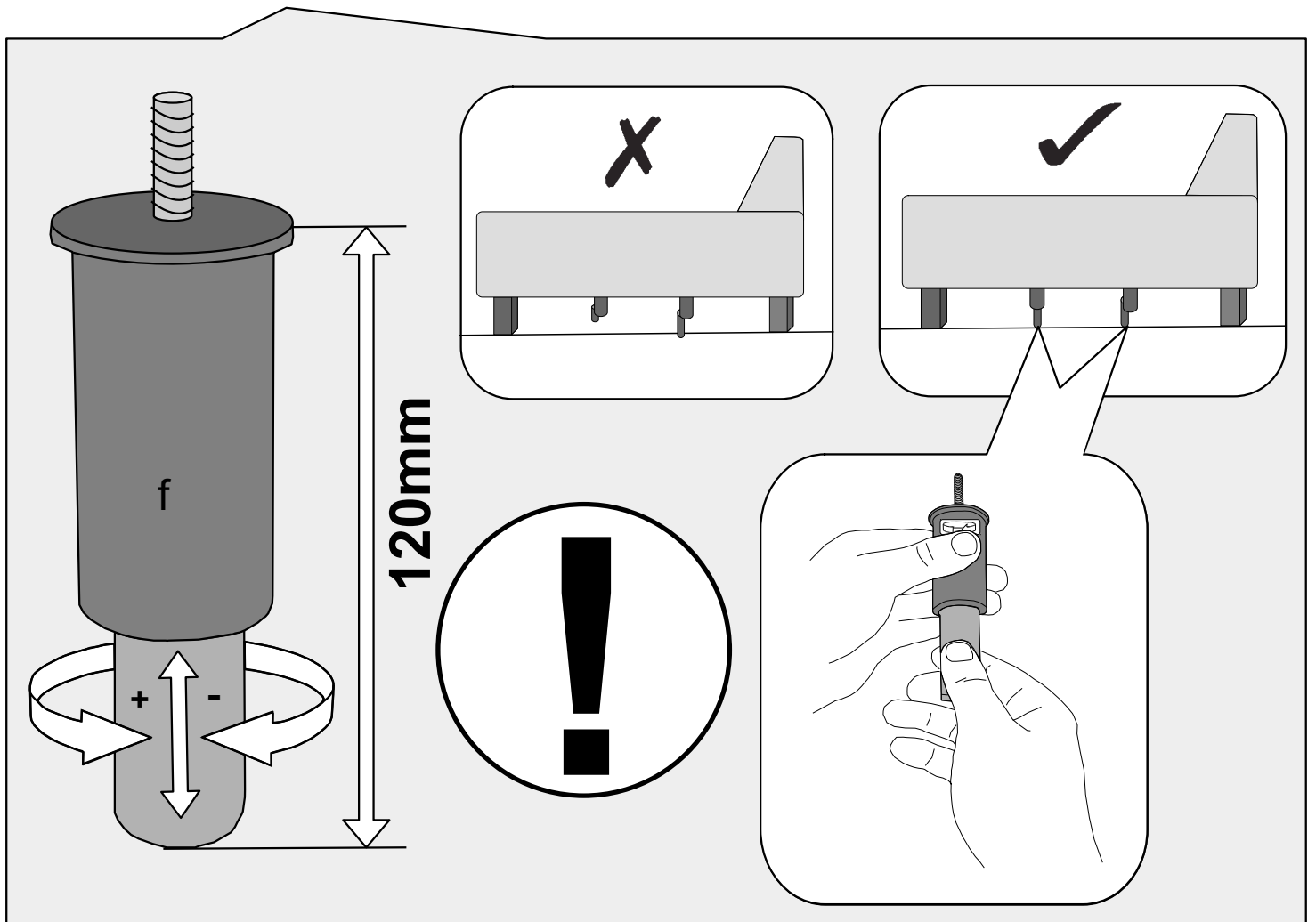
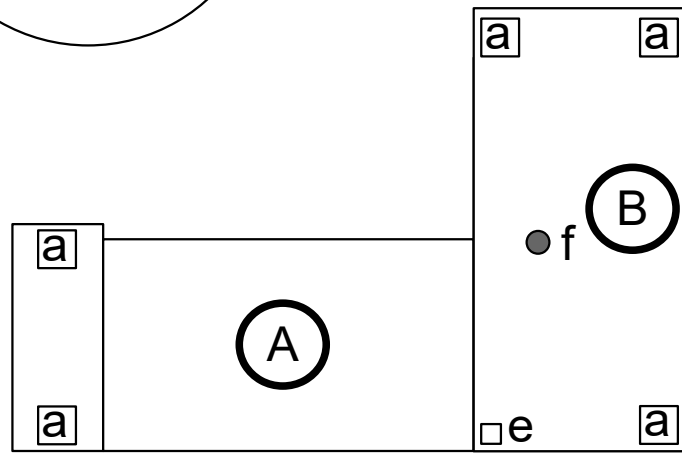
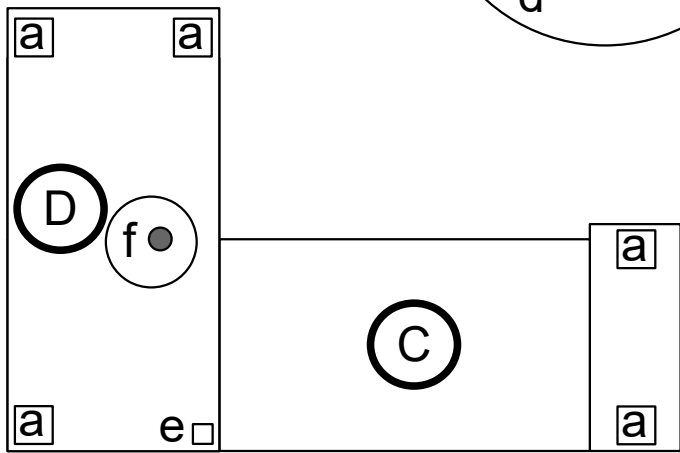
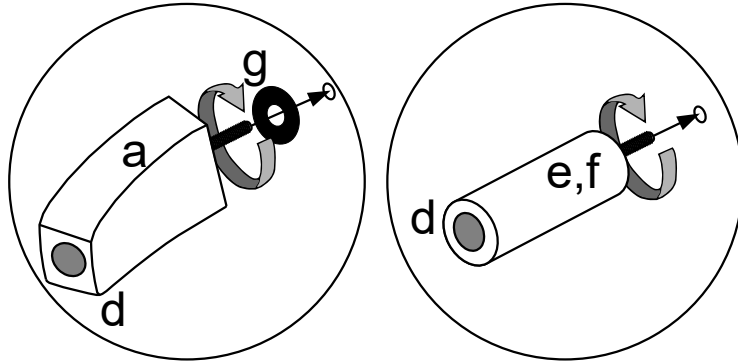
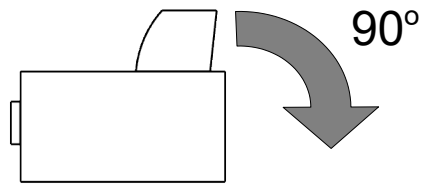

v4

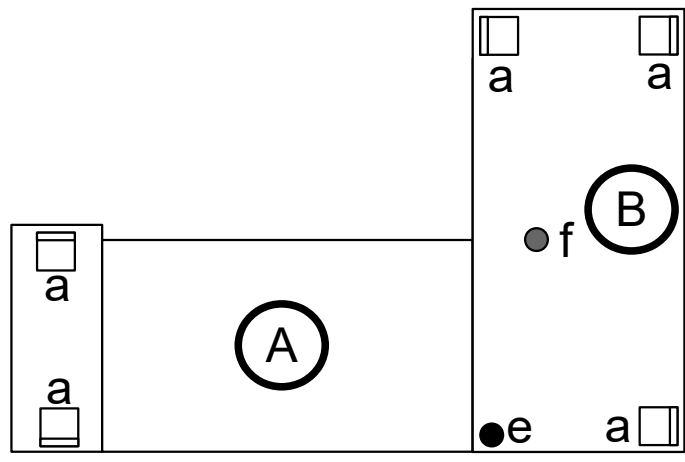
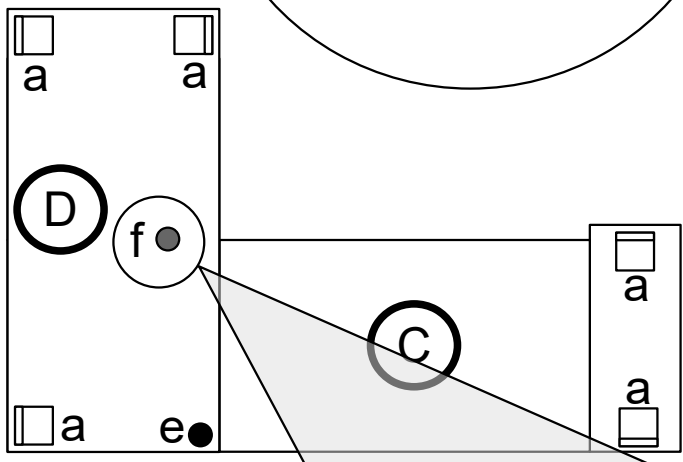
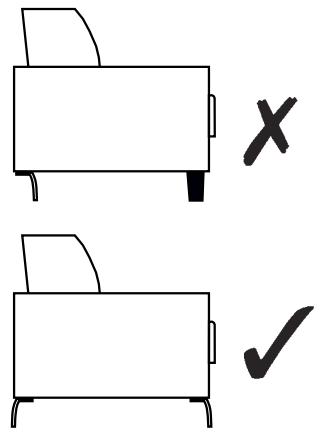
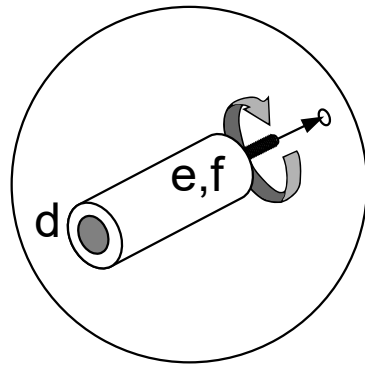
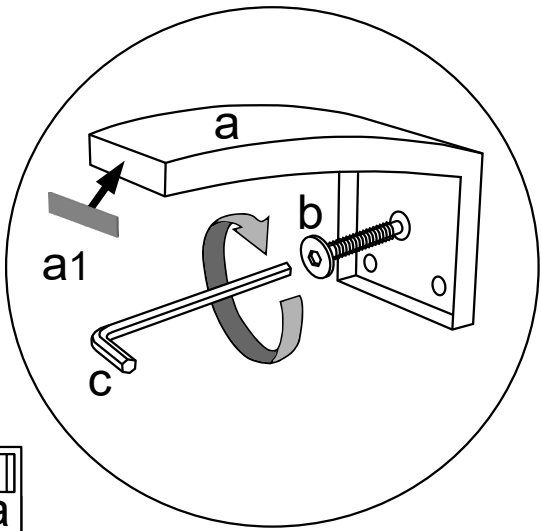
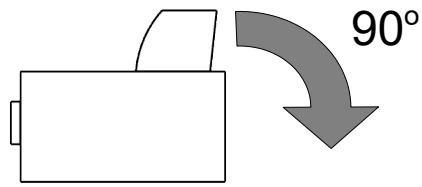

120mm

f

+

-

!

v6 v7

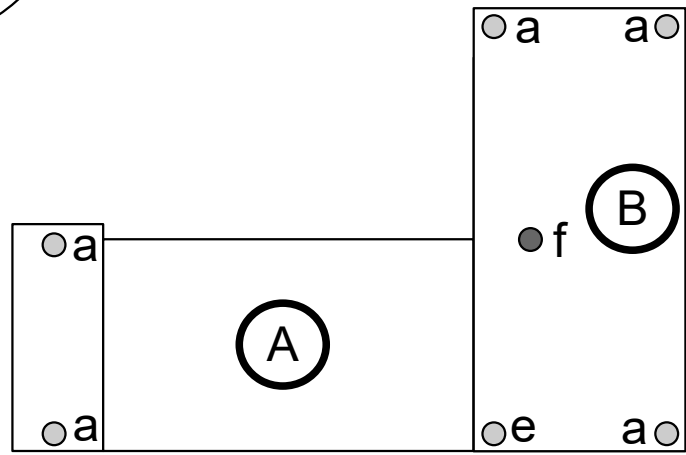
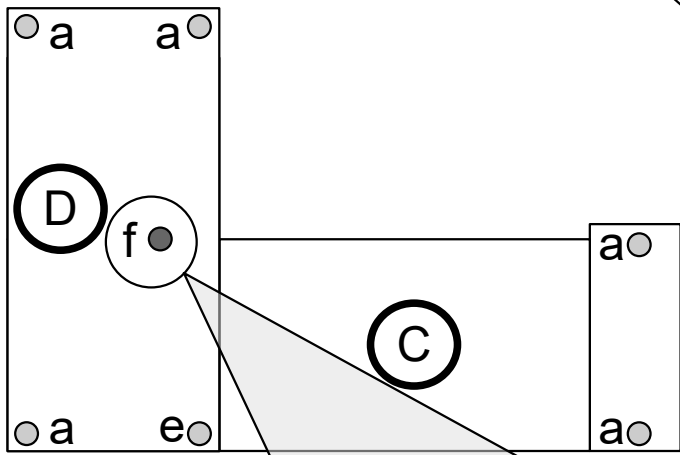
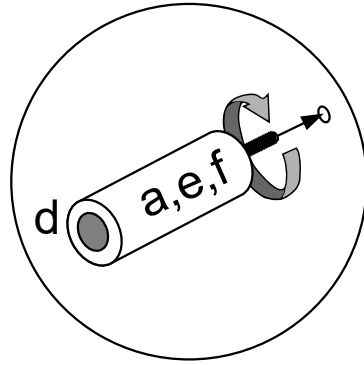
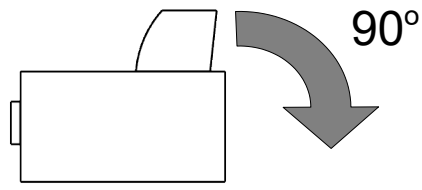

A large assembly diagram. On the left, a cylindrical component labeled 'f' is shown with a threaded rod on top. A vertical double-headed arrow indicates a length of 120mm. Below the component, a vertical double-headed arrow is labeled '+', and a horizontal double-headed arrow is labeled '-'. To the right, there are two inset diagrams: the left one shows a component with a tab and is marked with a large 'X'; the right one shows a component with a tab and two pins inserted into holes, marked with a checkmark. Below these is a large circle containing an exclamation mark. At the bottom right, a hand is shown holding the component.

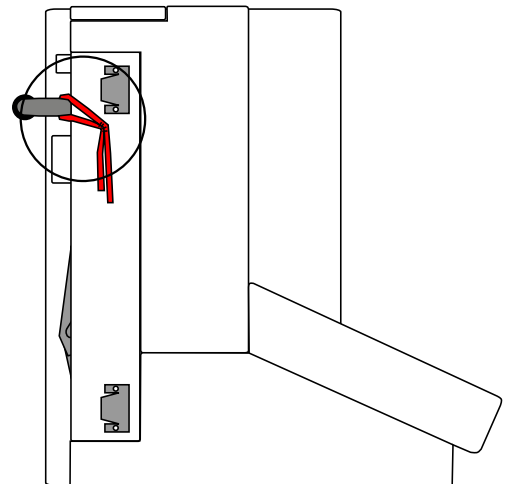
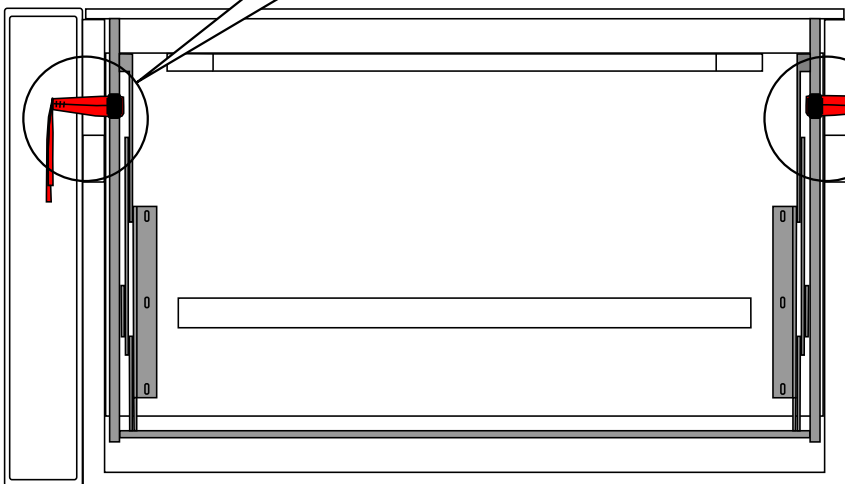
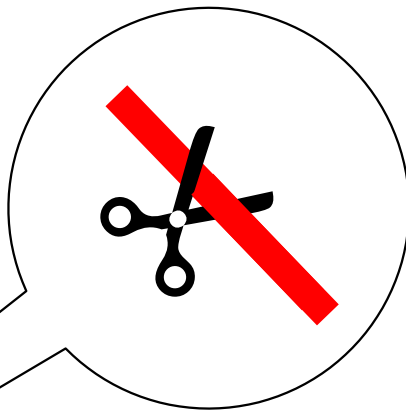
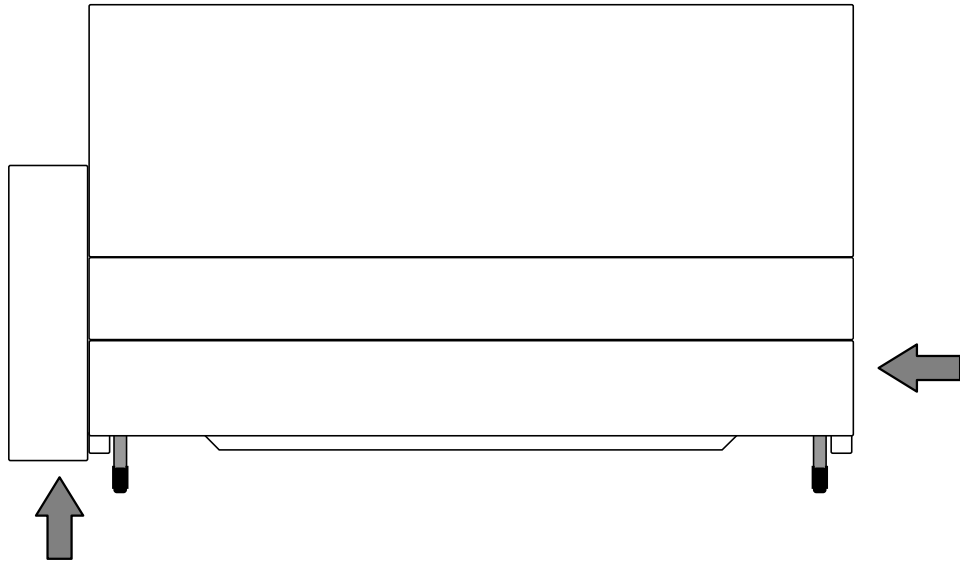
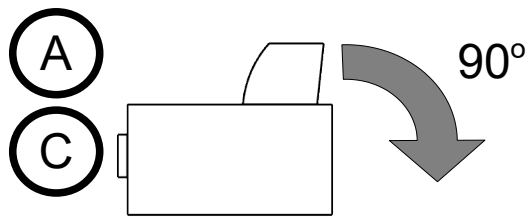

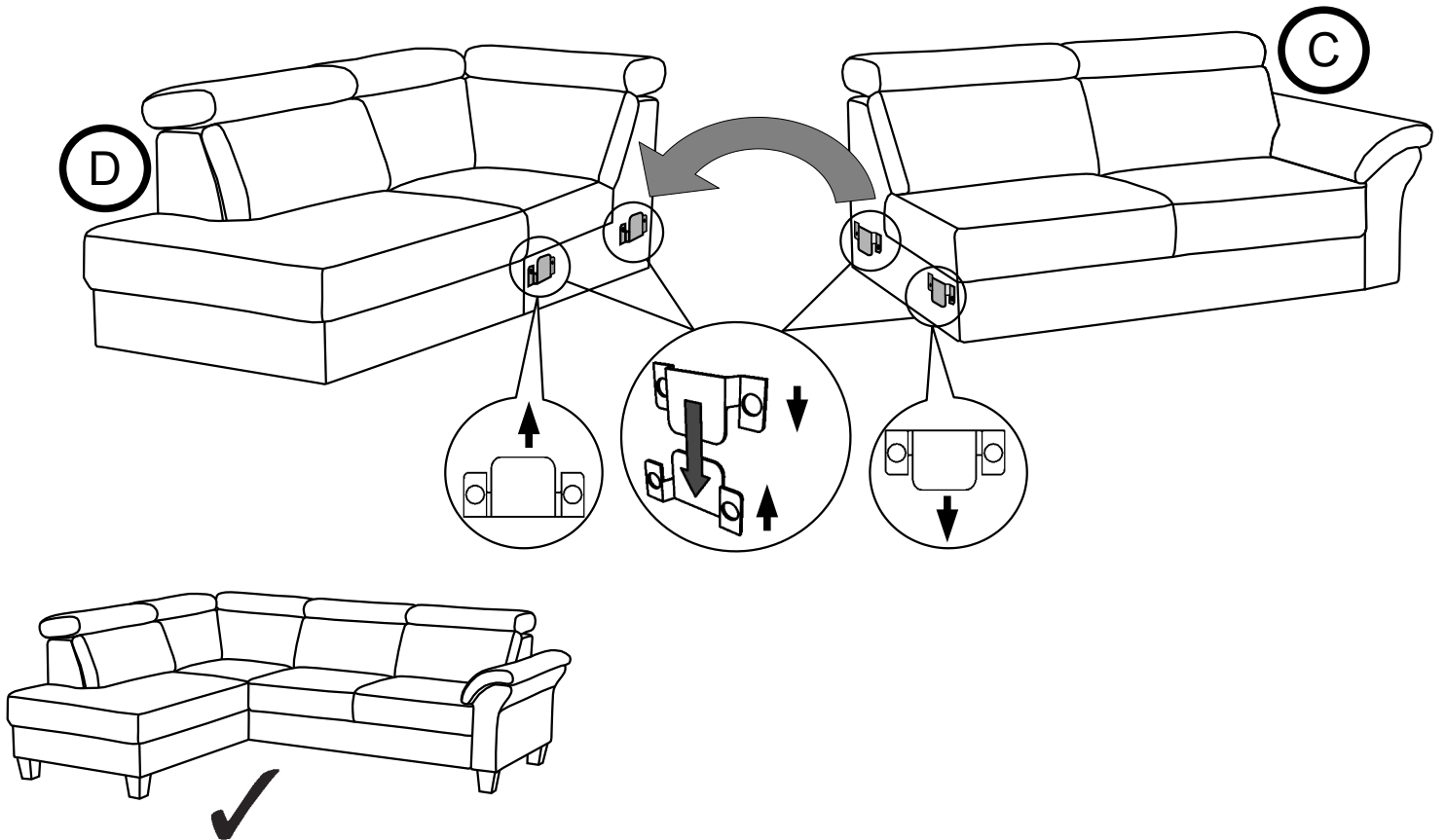
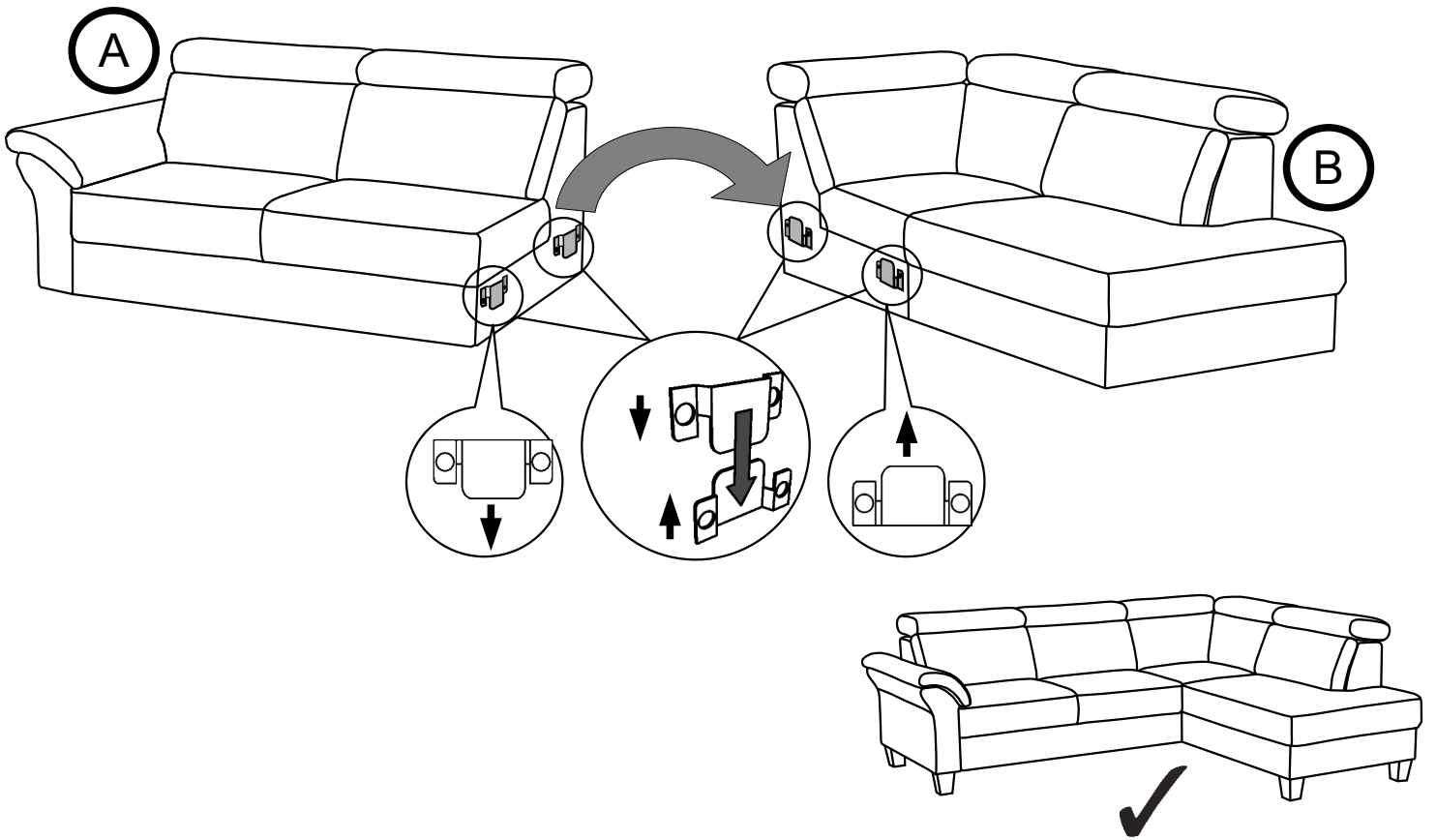
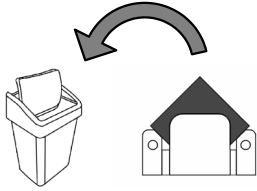

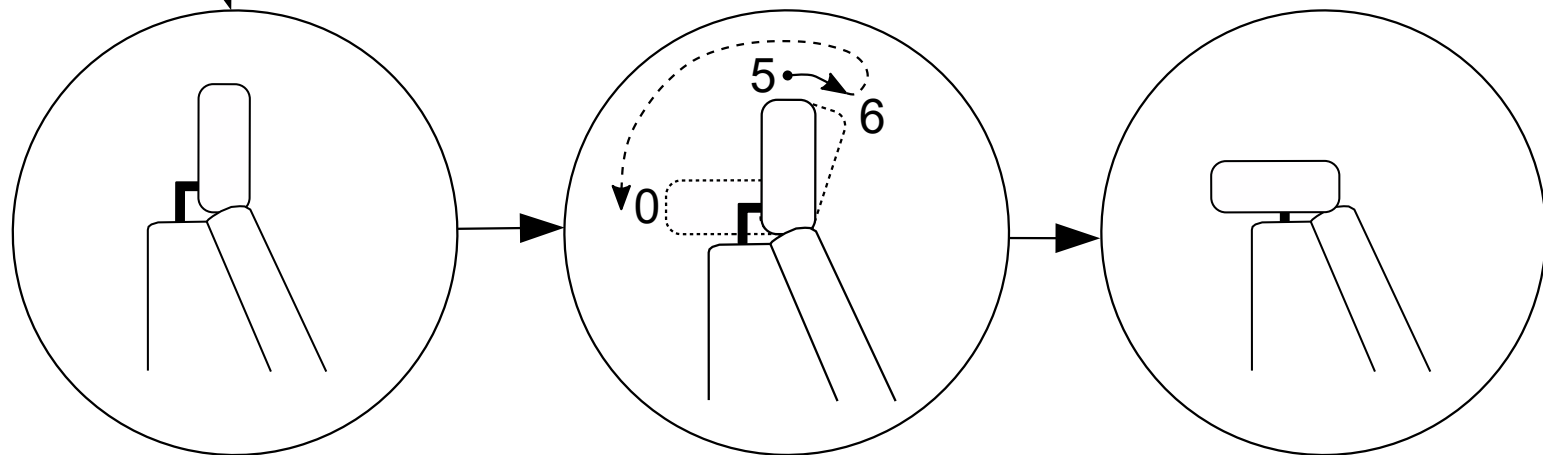
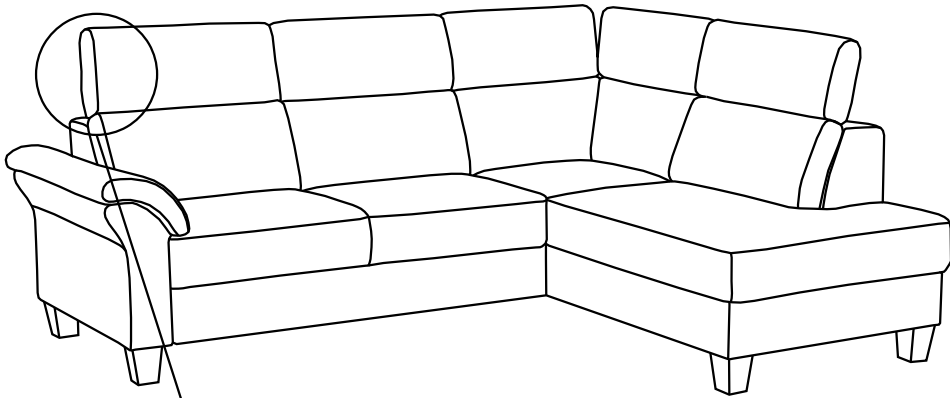
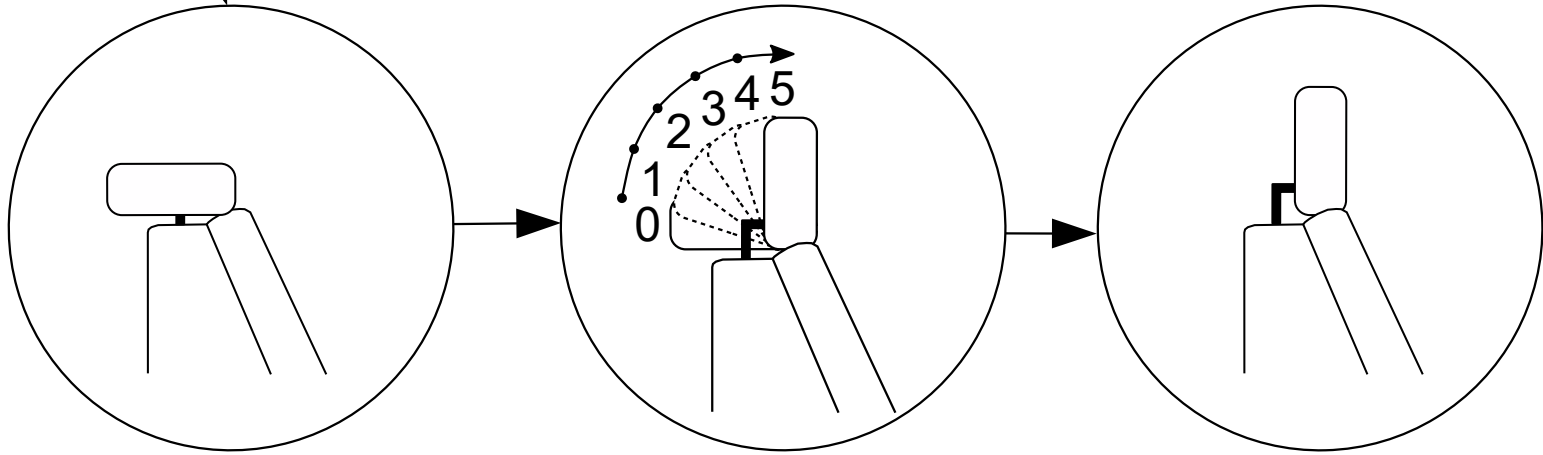
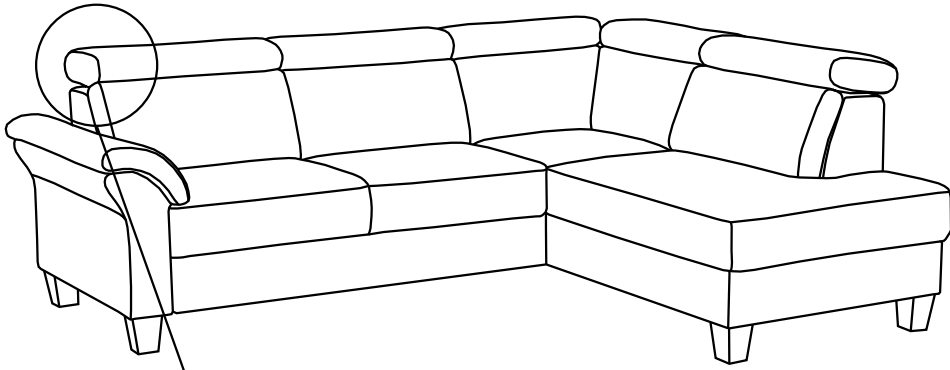
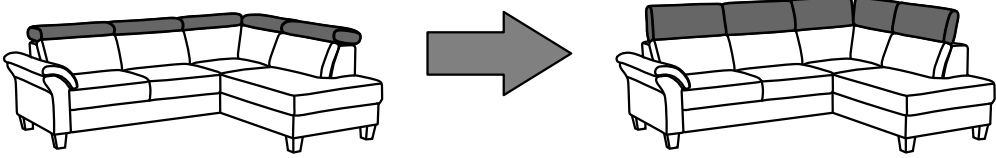
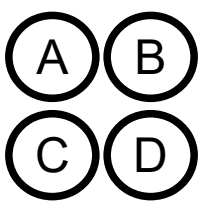

8

A C

