

SCARLETT V
8141-0064/2503-0064/8300-0064
8100-0064/2501-0064/8142-0064

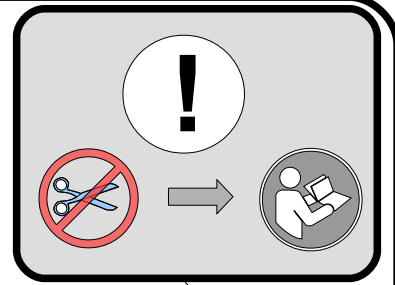

191001

- | | | | |
|-----------|--|-----------|---|
| D | MONTAGEANLEITUNG
BEDIENUNGSANLEITUNG | GB | ASSEMBLY INSTRUCTIONS
INSTRUCTION MANUAL |
| NL | HANDLEIDING VOOR DE MONTAGE
GEBRUIKSAANWIJZING | PL | INSTRUKCJA MONTAŻU
INSTRUKCJA OBSŁUGI |
| TR | MONTAJ TALIMATI
KULLANIM KLAVUZU | RU | ИНСТРУКЦИЯ ПО МОНТАЖУ
ИНСТРУКЦИЯ ПО ЭКСПЛУАТАЦИИ |
| RO | INSTRUCȚIUNI DE INSTALARE
INSTRUCȚIUNI DE UTILIZARE | IT | ISTRUZIONI DI MONTAGGIO
MANUALE DI ISTRUZIONI |
| FR | NOTICE DE MONTAGE
MANUEL INSTRUCTIONS | SK | MONTÁŽNY NÁVOD
NÁVOD NA POUŽITIE |
| HU | KÖZGYŰLÉS UTASÍTÁSOK
KEZELÉSI UTASÍTÁS | CZ | MONTÁŽNÍ NÁVOD
NÁVOD K POUŽITÍ |
| SI | NAVODILA ZA MONTAŽO
NAVODILA ZA UPORABO | PT | INSTRUÇÕES DE MONTAGEM
MANUAL DO USUÁRIO |
| ES | INSTRUCCIONES DE MONTAJE
MANUAL DEL USUARIO | HR | UPUTE ZA MONTAŽU
UPUTE ZA UPOTREBU |

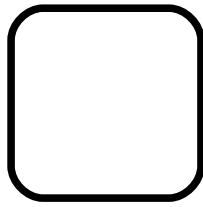
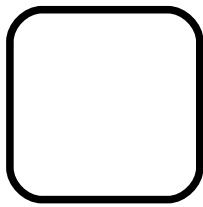

0088

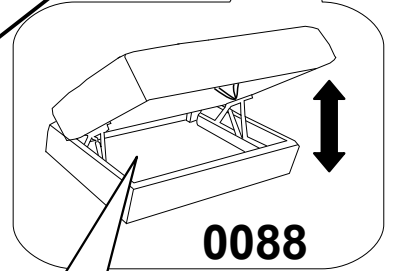
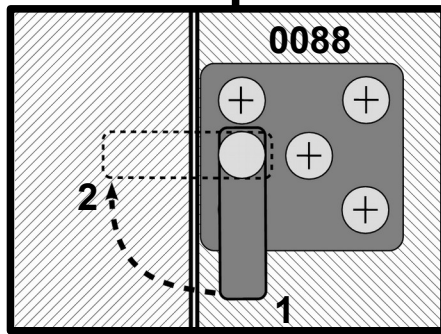
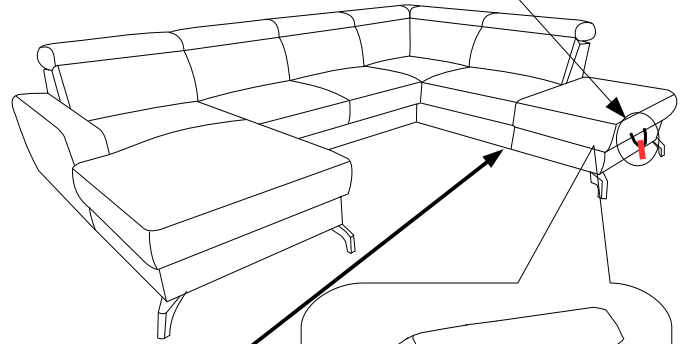
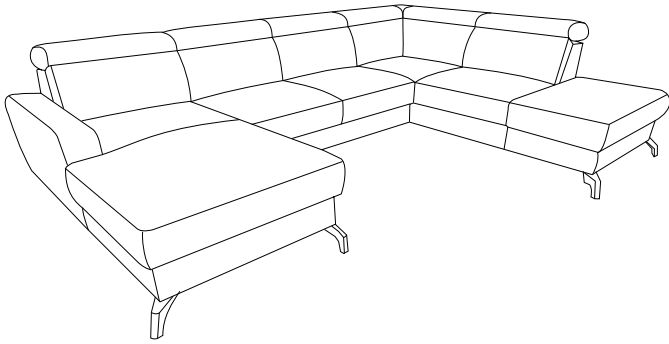

0088

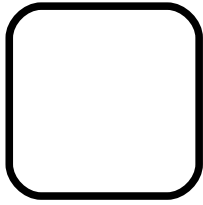
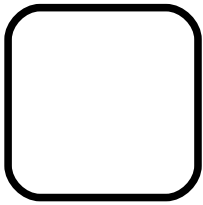

0089

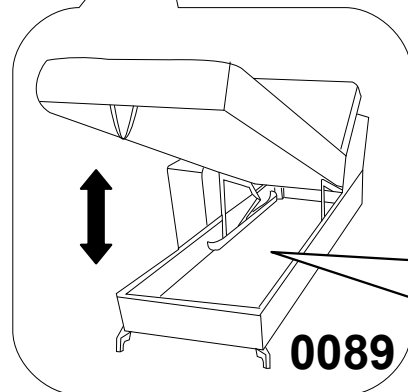
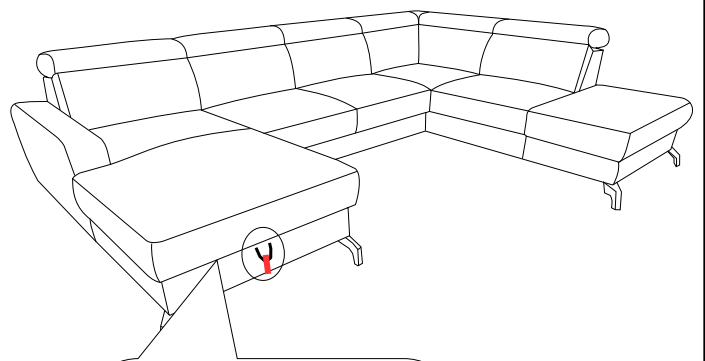
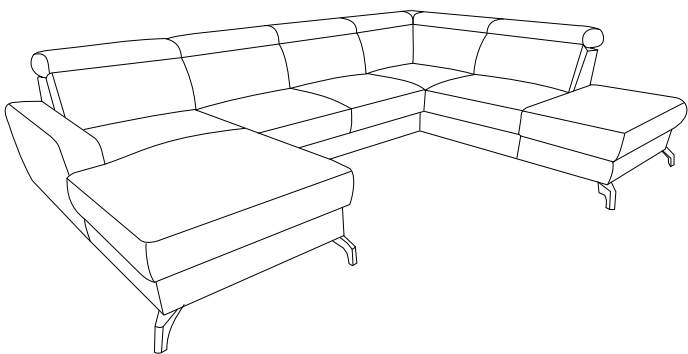

0089



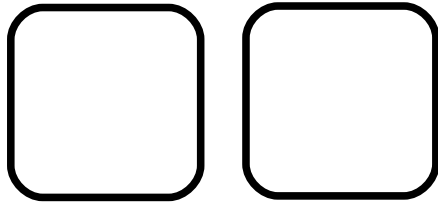

0019

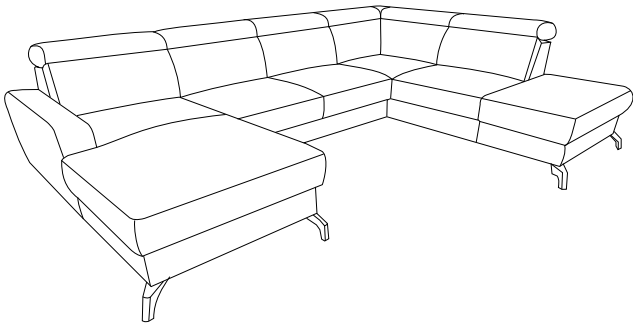





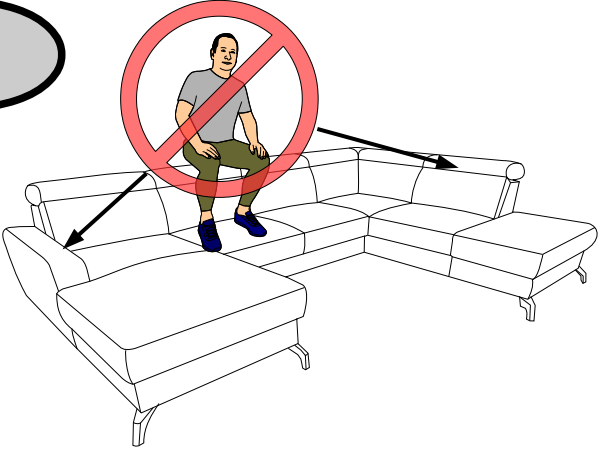

0019

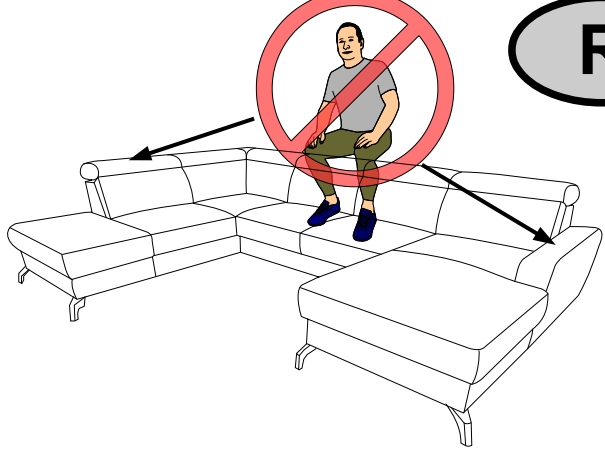
L







R

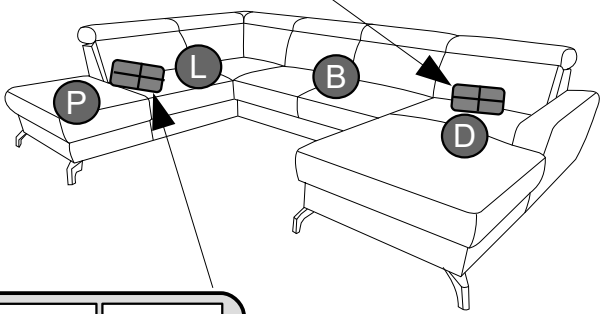
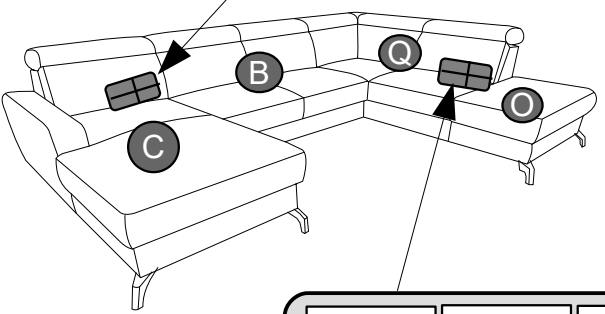





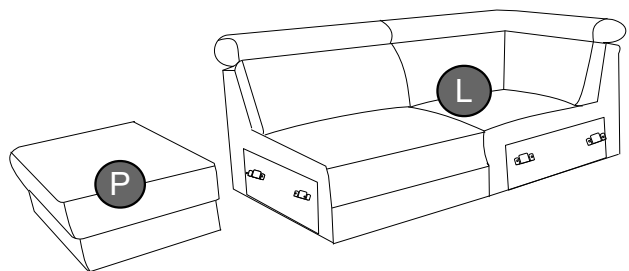
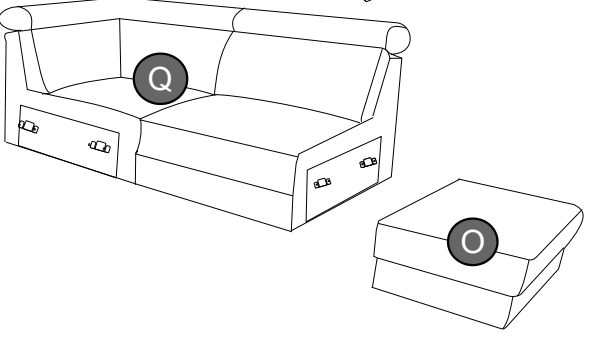
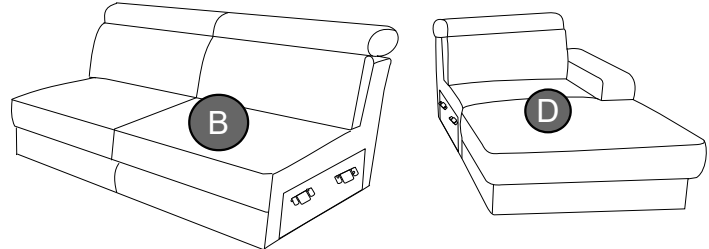
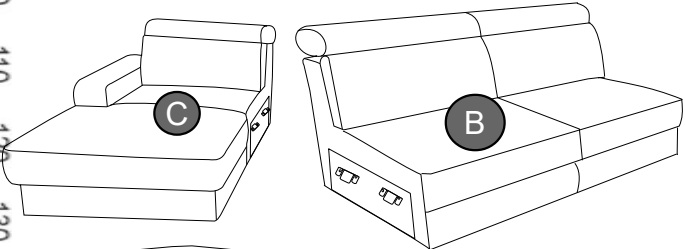

f H- 120  X1	g H- 120  X2	s H- 120  S1 X3	q M6*25  X12	i L- 4  X1	[mm]
--	--	--	--	--	------







f H- 120  X1	g H- 120  X3	s H- 120  S1 X3	q M6*25  X12	i L- 4  X1
--	--	--	--	--

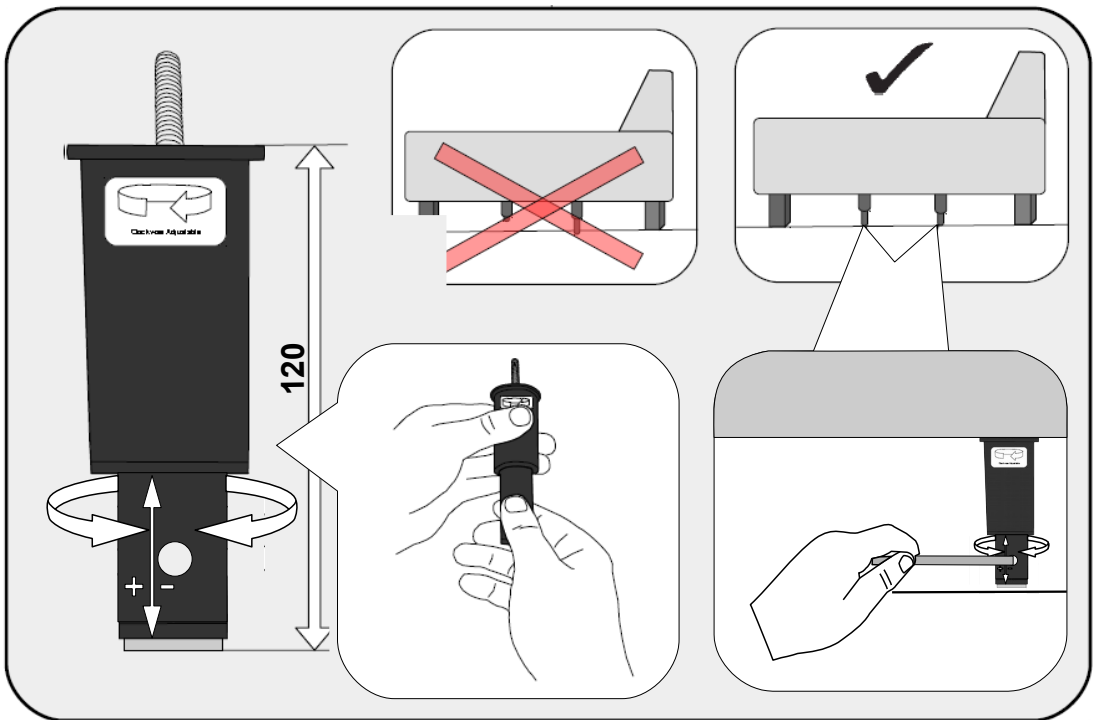
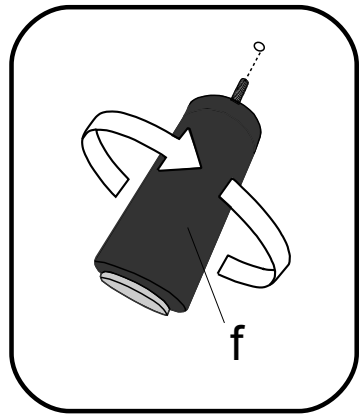
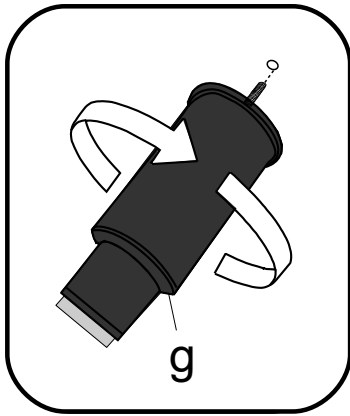
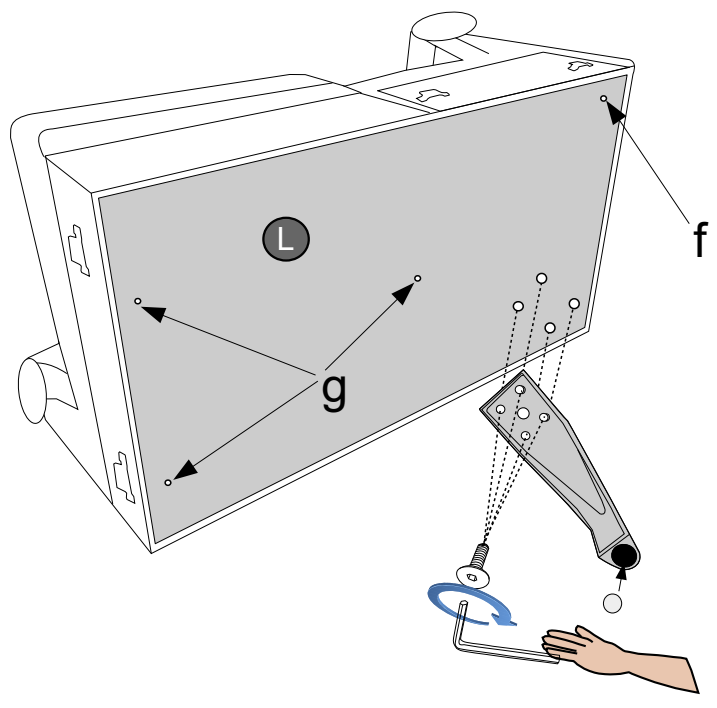
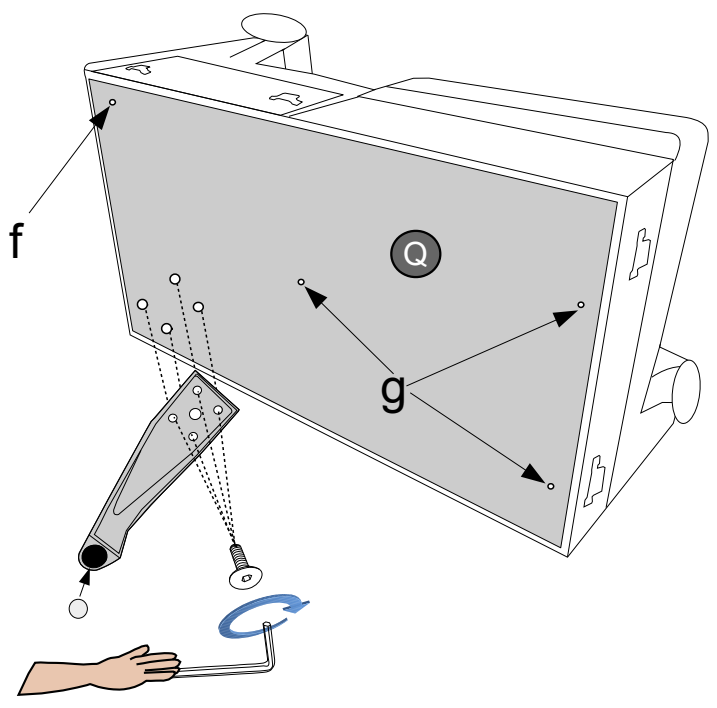

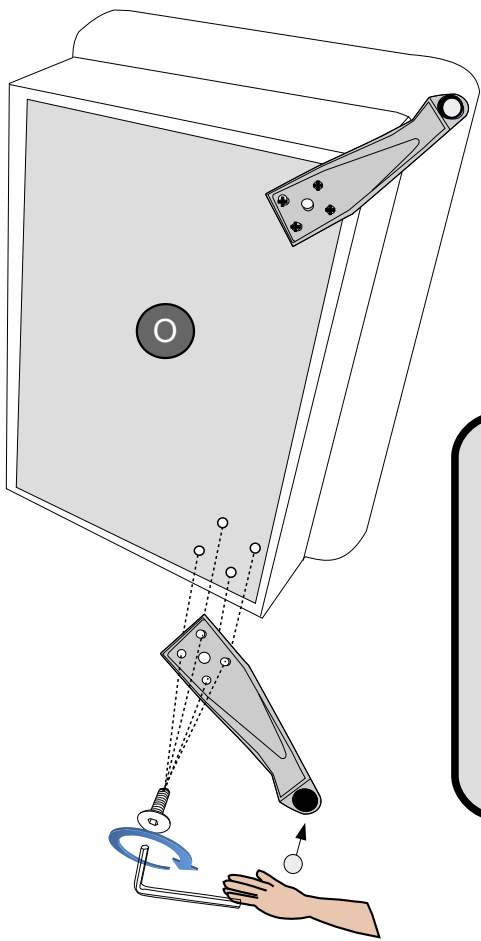





s H- 120  s1 	q M6*25 	i L- 4 	f H- 120 	g H- 120 
X1	X4	X1	X1	X3

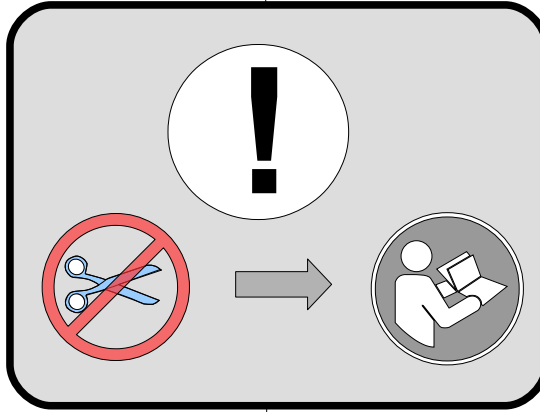
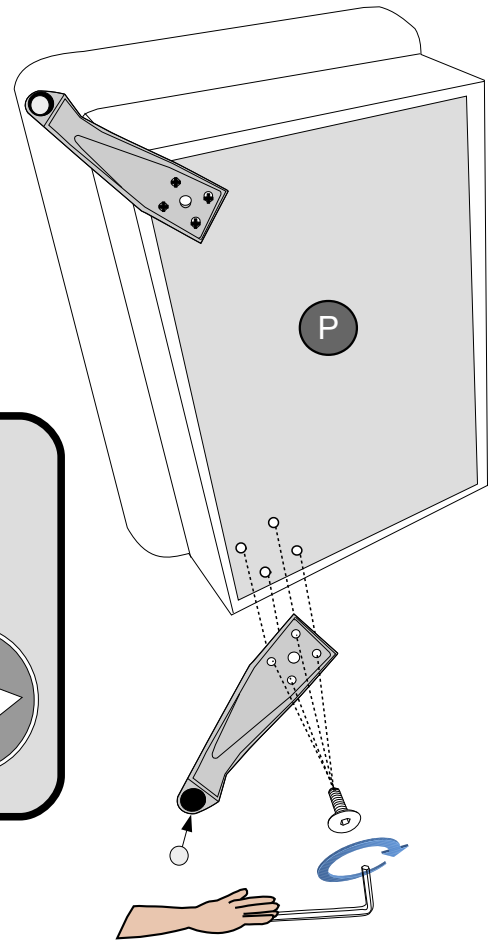



s H- 120 	q M6*25 	i L- 4 
X2	X8	X1



s H- 120 	q M6*25 	i L- 4 	f H- 120 	x Fi- 35 	g H- 120 
X3	X12	X1	X1	X1	X2

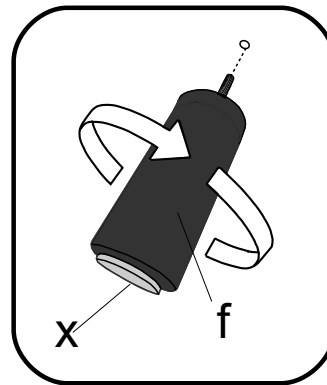
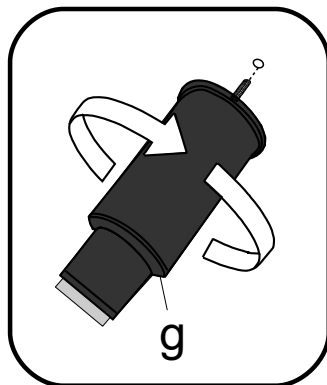
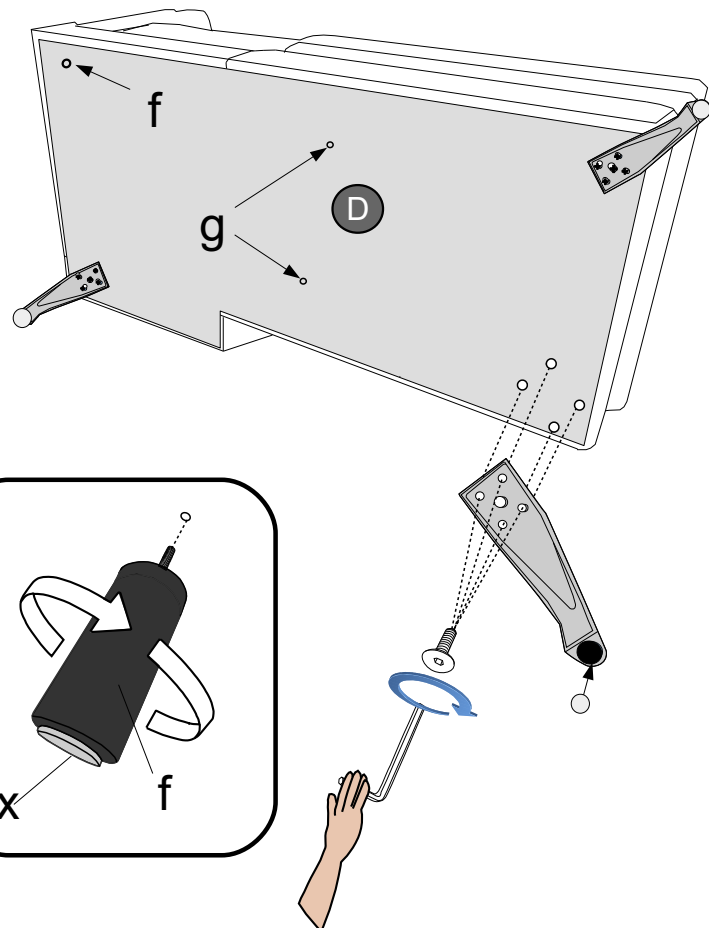
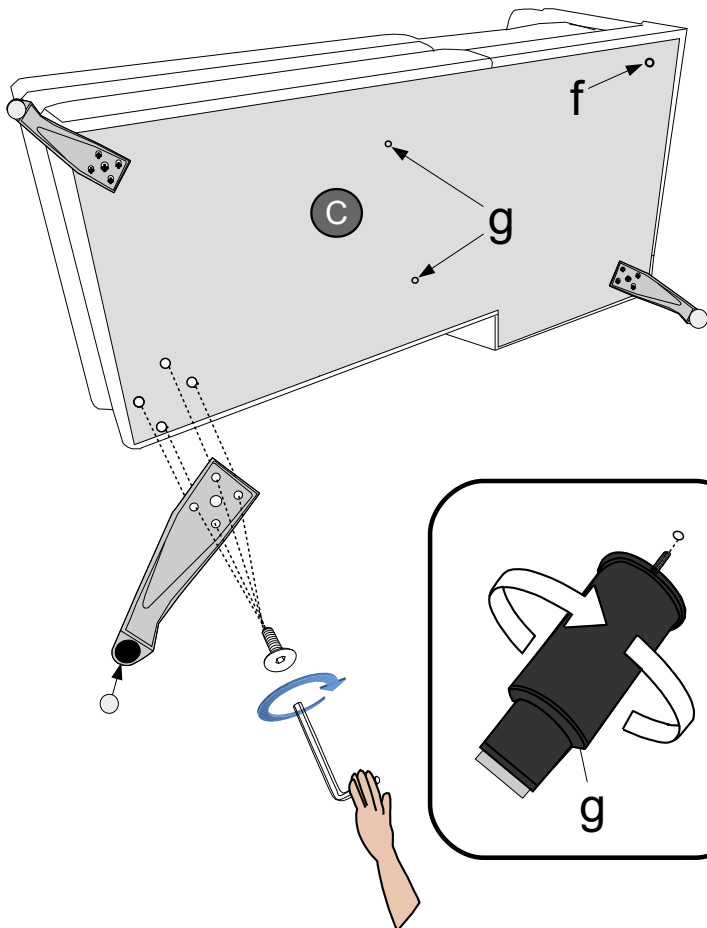

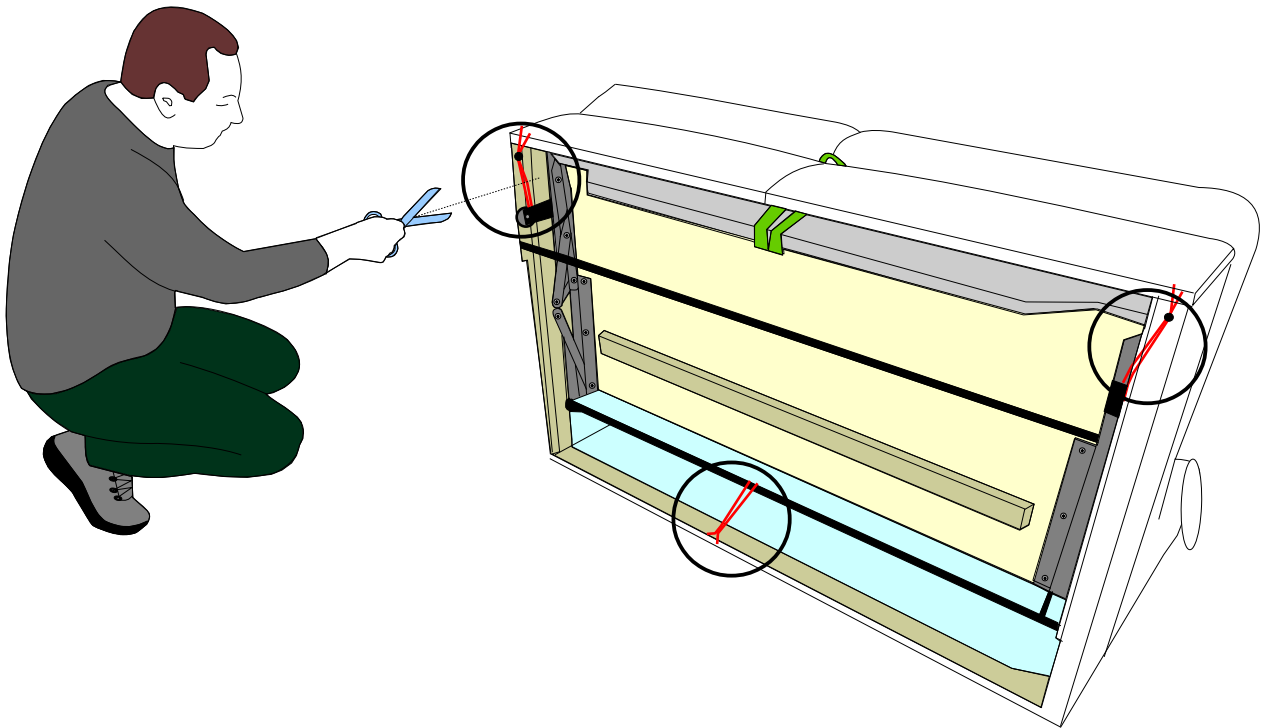
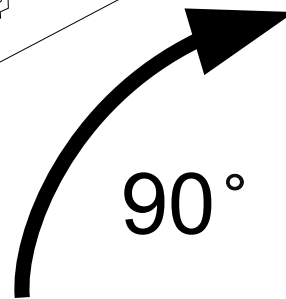
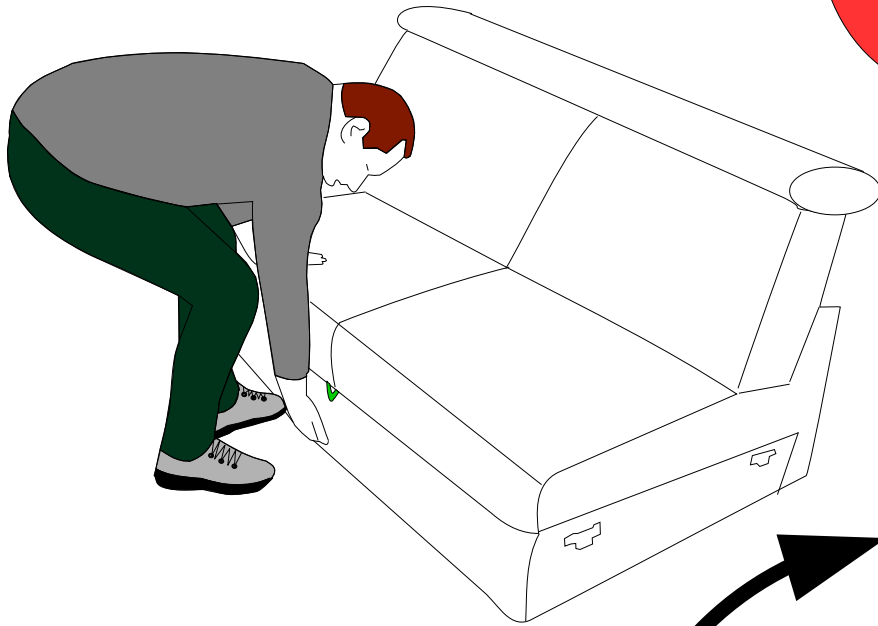

0019

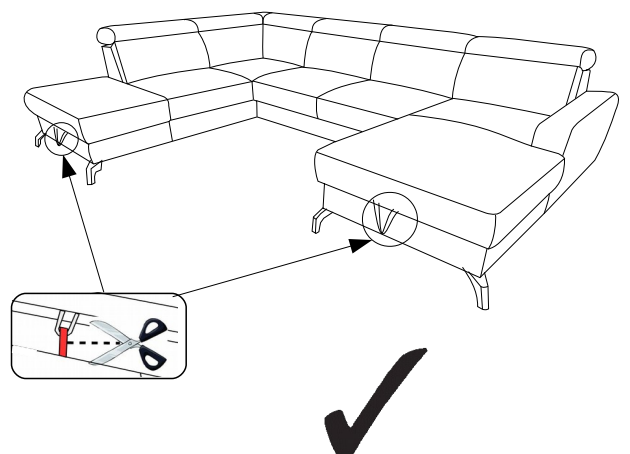
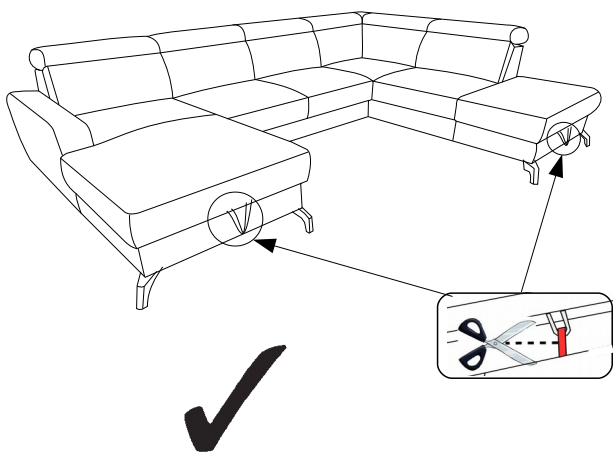
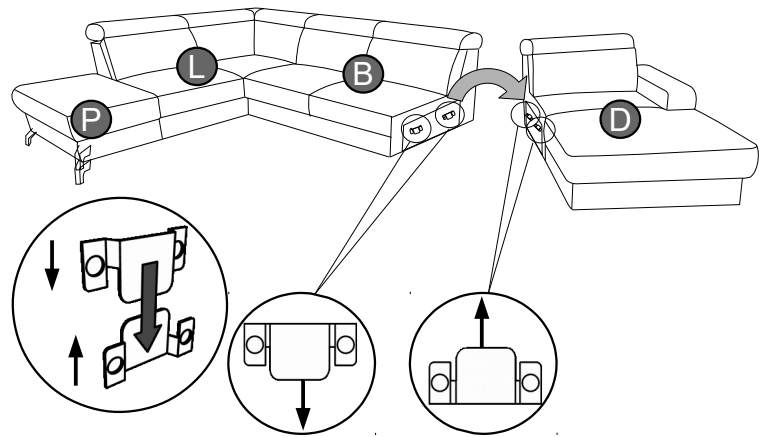
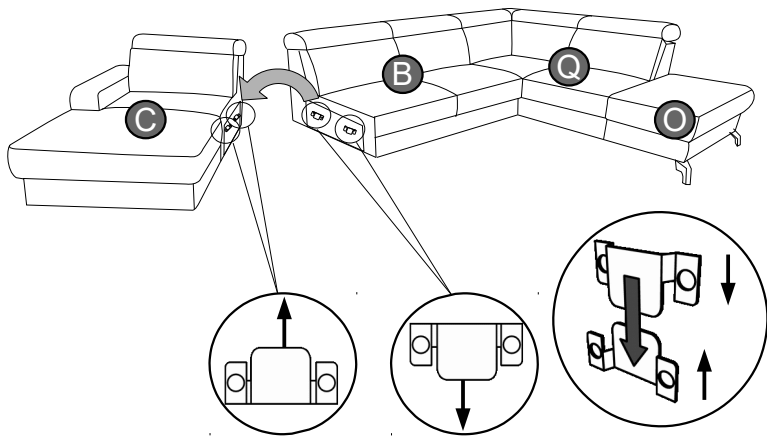
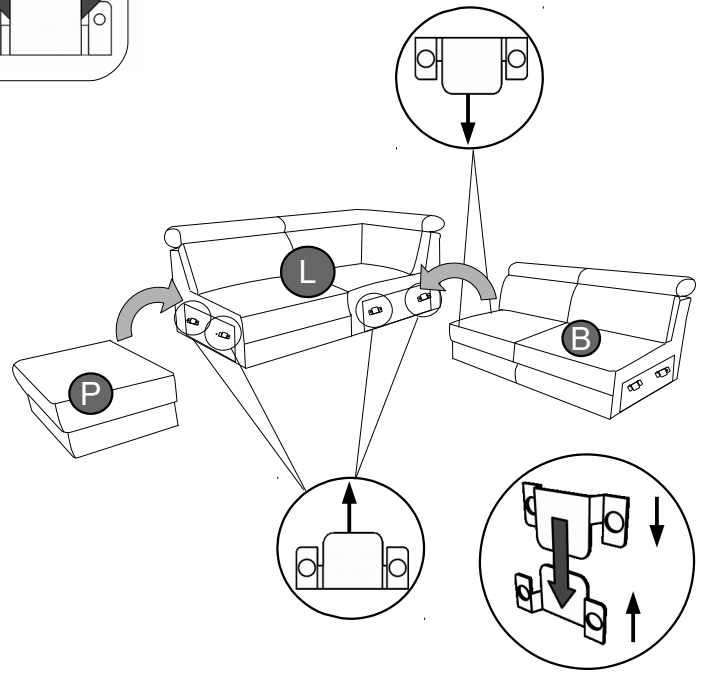
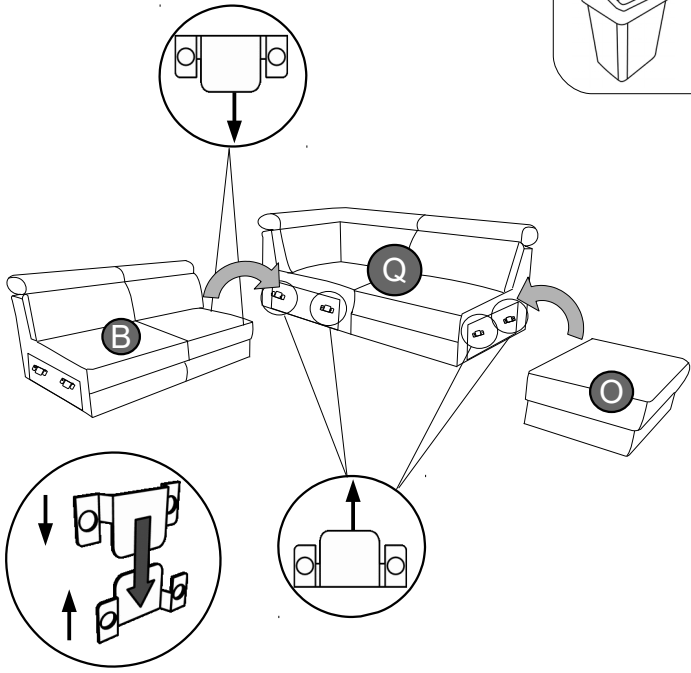
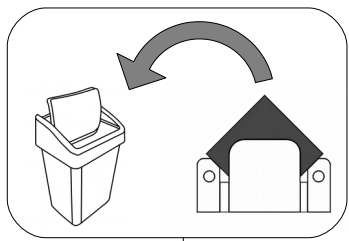

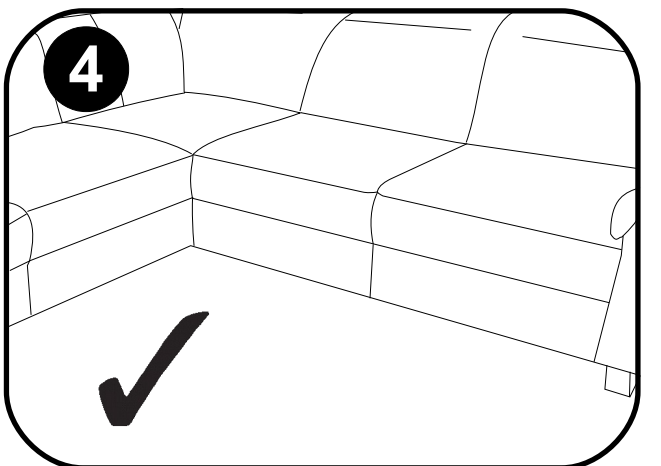
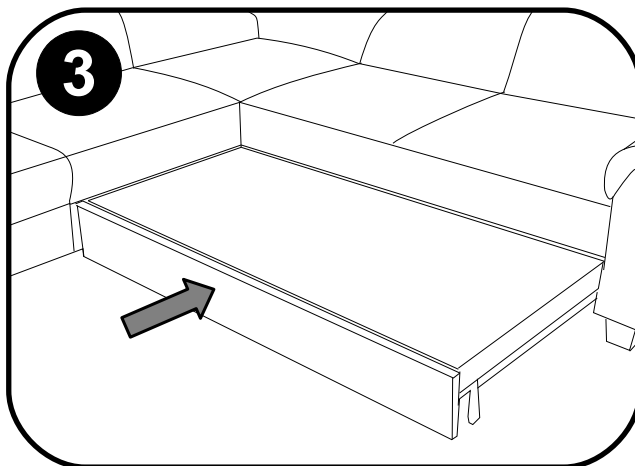
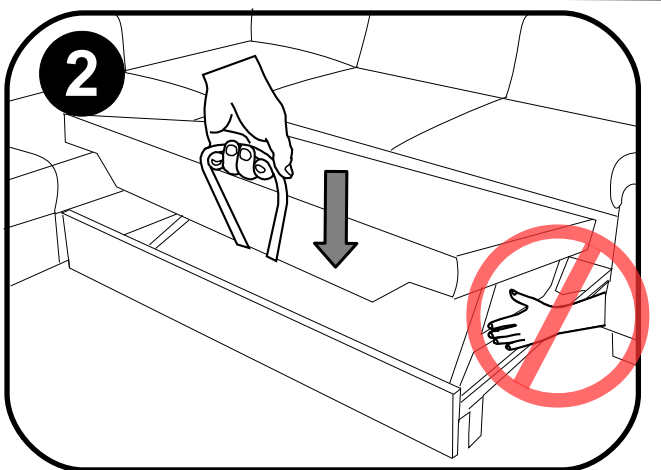
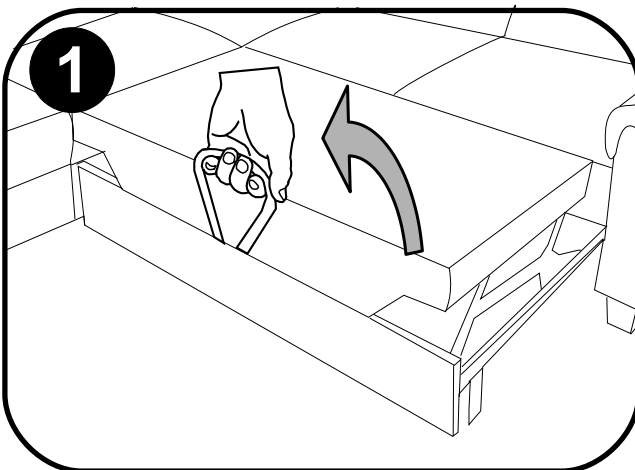
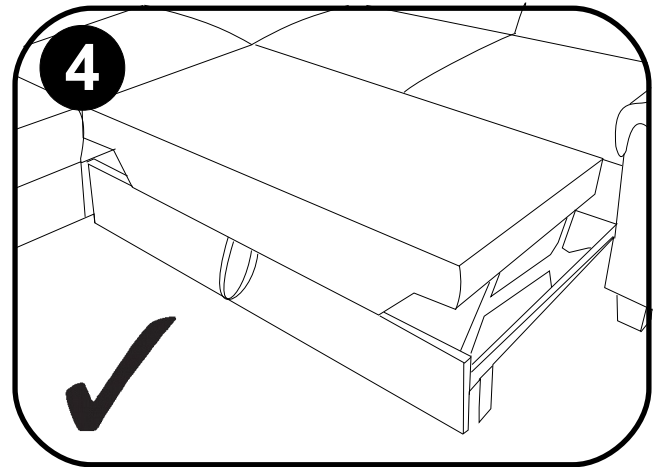
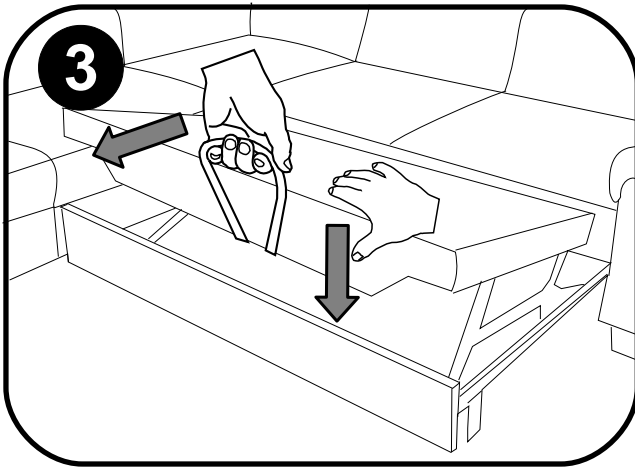
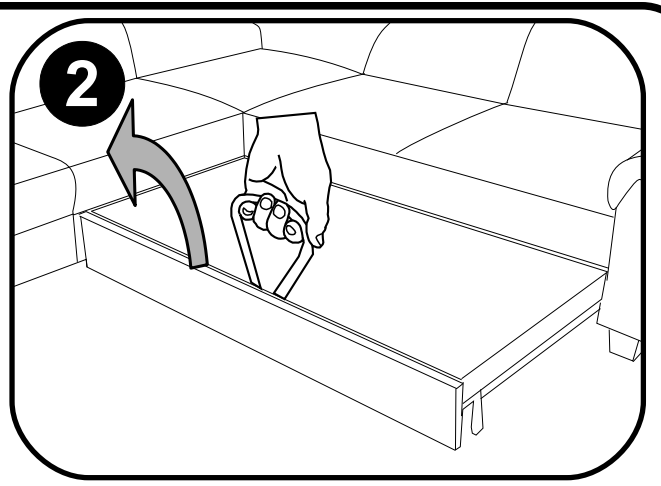
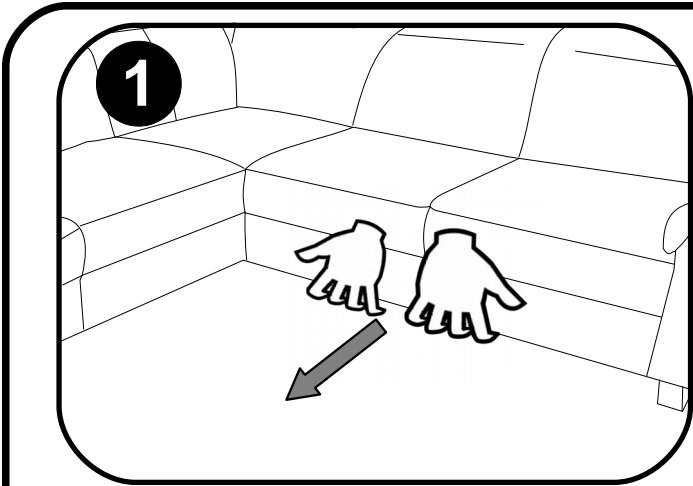
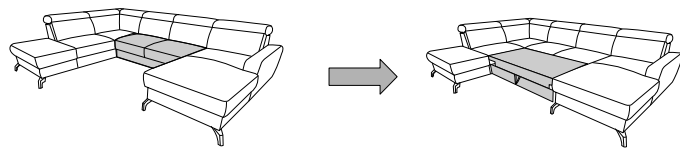

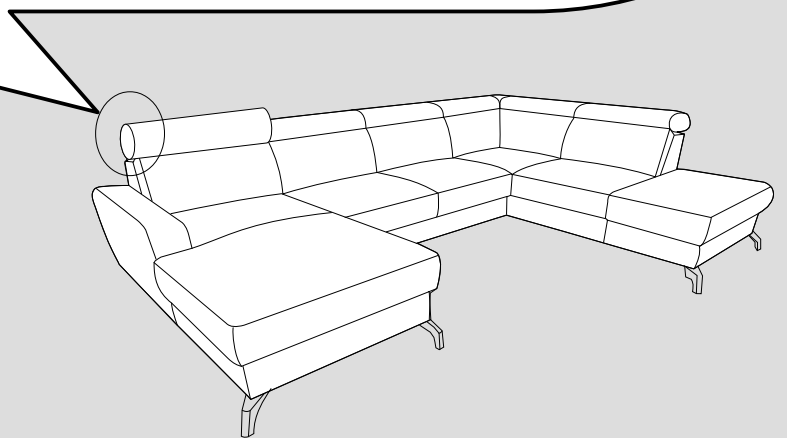
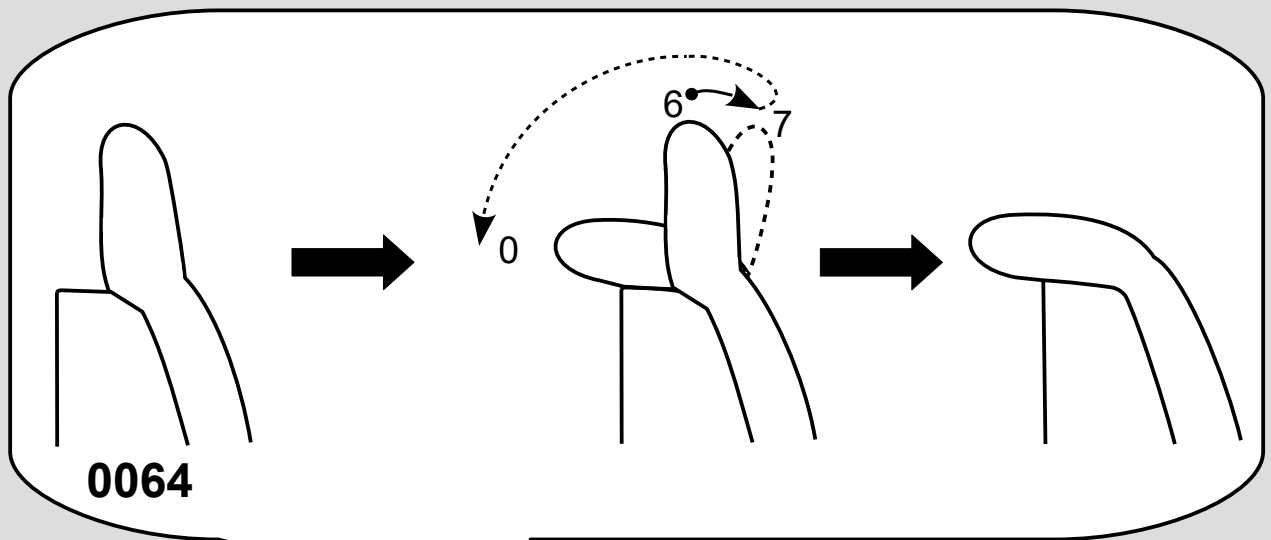
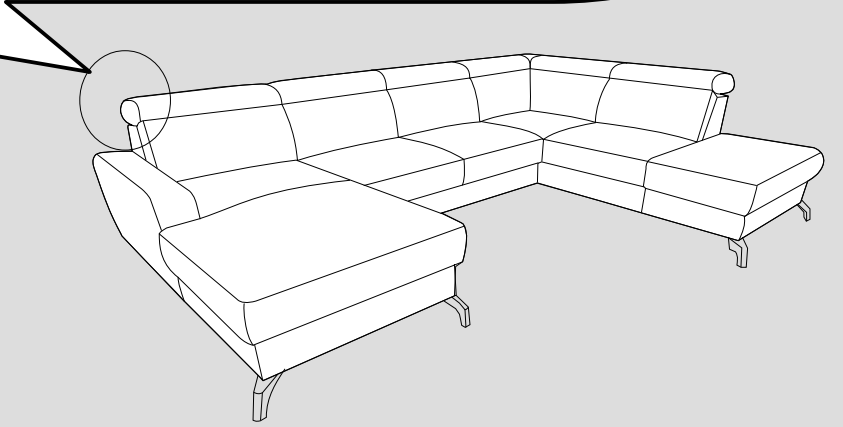
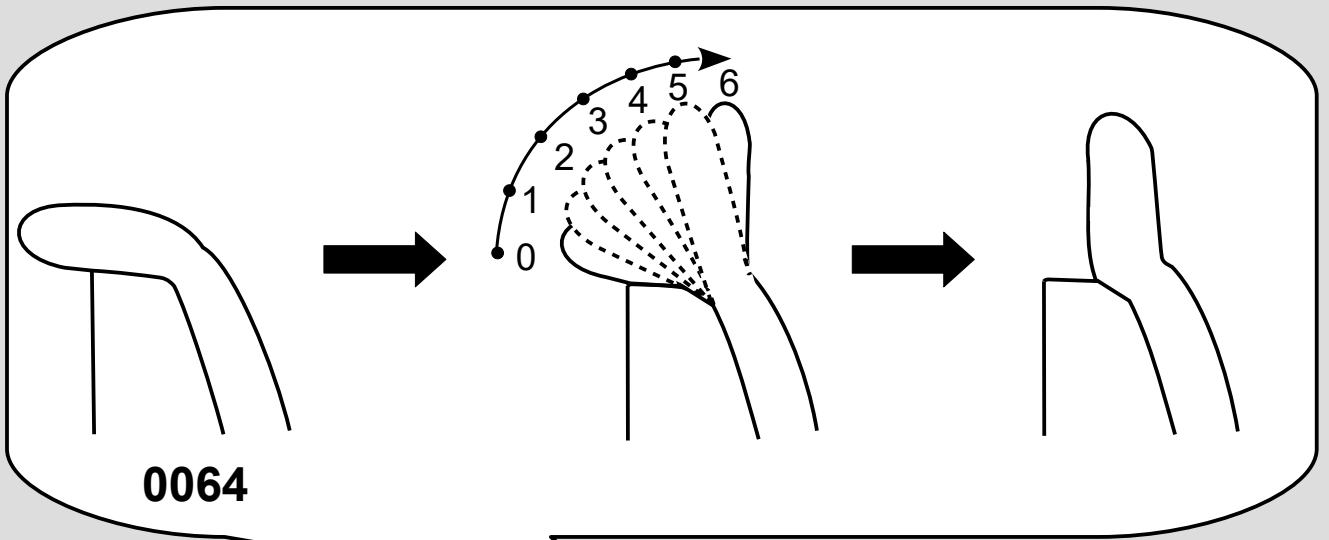

Name · Naam · Nazwa · Ísim · Название · Nume · Nome · Názov · Názov ·
 Název · Neve

SCARLETT V

Typ · Type · Tip · Тип · Tipo · Típus

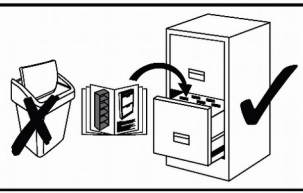
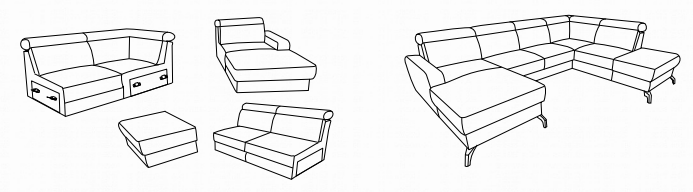

L

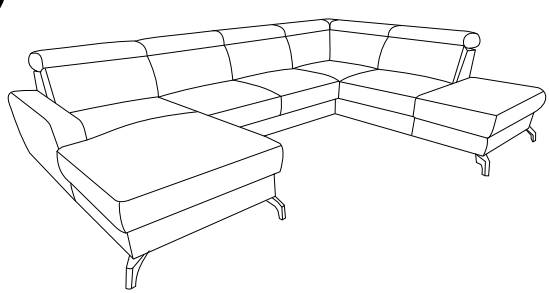

R

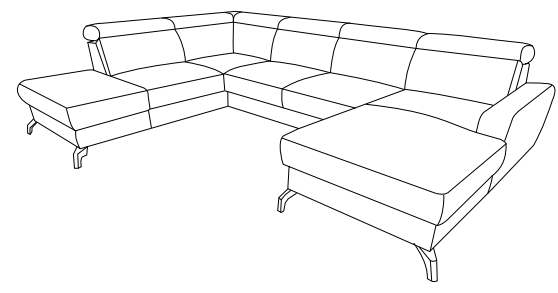

f H- 120	g H- 120	s H- 120	q M6*25	i L- 4 [mm]
		S1		

