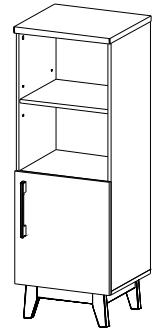

roba

roba Baumann GmbH

Feldstraße 14
96237 Ebersdorf
0 95 62. 92 21-20
info@roba-kids.com
www.roba-kids.com

www.blauer-engel.de/uz38**1311792 Standregal. Shelf****,Finn'**

Aufbauanleitung . Assembly Instructions . Instruction d'assemblage . Instrucciones de montaje . Instruções de montagem . Istruzioni di montaggio . Opbouwhandleiding . Byggevejledning . Monteringsanvisning . Asennusohjeet . Monteringsinstruksjoner . Instrukcja montażu . Návod k sestavení . Szerelési útmutató . Skupština Upute . Instrucțiuni de asamblare . Uputstvo za sastavljanje . Montážny návod . Navodila za montažo . Montaj talimatı . Οδηγίες Συναρμολόγησης . Руководство по сборке

- DE** WICHTIG! - FÜR SPÄTERE VERWENDUNG AUFBEWAHREN - SORGFÄLTIG LESEN!
- UK** ATTENTION! - PLEASE STORE FOR FURTHER ENQUIRIES! READ CAREFULLY!
- FR** IMPORTANT! - CONSERVER POUR UNE UTILISATION ULTÉRIEURE - LIRE ATTENTIVEMENT!
- ES** ¡ATENCIÓN! - GUARDAR PARA UN USO POSTERIOR. - LÉASE DETENIDAMENTE!
- PT** IMPORTANTE! – GUARDAR PARA FUTURAS CONSULTAS – LER COM ATENÇÃO!
- IT** IMPORTANTE! CONSERVARE PER L'USO FUTURO - LEGGERE CON ATTENZIONE!
- NL** BELANGRIJK! - BEWAAR DE HANDLEIDING VOOR LATERE RAADPLEGING! ZORGVULDIG LEZEN!
- DK** VIGTIGT! BØR OPBEVARES TIL SENERE BRUG - SKAL LÆSES GRUNDIGT!
- SE** VIKTIGT! SPARAS FÖR FRAMTIDA BRUK - MÅSTE LÄSAS NOGA!
- FI** TÄRKEÄÄ! - SÄILYTÄ MYÖHEMPÄÄ KÄYTTÖÄ VARTEN – LUE TARKKAVAISESTI!
- NO** VIKTIG! – OPPBEVARES FOR SENERE BRUK – MÅ LESES NØYE!
- PL** WAŻNE! ZACHOWAĆ NA PRZYSZŁOŚĆ! STARANNIE PRZECZYTAĆ!
- CZ** DŮLEŽITÉ! - NÁVOD SI USCHÓVEJTE PRO POZDĚJŠÍ POUŽITÍ! - PEČLIVĚ SI JEJ PROČTĚTE!
- HU** FONTOS! – KÉSŐBBI FELHASZNÁLÁSRA ŐRIZZE MEG – GONDOSAN OLVASSA EL!
- HR** VAŽNO! - SAČUVATI ZA KASNIJU UPORABU – PAŽLJIVO PROČITATI!
- RO** IMPORTANT! - PĂSTRAȚI PENTRU UTILIZARE ULTERIOARĂ - CITIȚI CU ATENȚIE!
- RS** VAŽNO! – ČUVATI ZA KASNIJU UPOTREBU – PAŽLJIVO SVE PROČITATI!
- SK** DÔLEŽITÉ! - NÁVOD UCHOVAJTE NA NEŠKORŠIE POUŽITIE – DÔKLADNE SI HO PREČÍTAJTE!
- SI** POMEMBNO! – SHRANITE ZA KASNEJŠO UPORABO – TEMELJITO PREBERITE!
- TR** ÖNEMLİ!-DAHA SONRA KULLANILMAK ÜZERE DE MUHAFZA EDİNİZ– DIKKATLE OKUYUNUZ!
- GR** ΣΗΜΑΝΤΙΚΟ! - ΝΑ ΦΥΛΑΣΣΕΤΑΙ ΓΙΑ ΑΡΓΟΤΕΡΗ ΧΡΗΣΗ - ΝΑ ΔΙΑΒΑΖΕΤΑΙ ΜΕ ΠΡΟΣΟΧΗ!
- RU** ВАЖНО: ВНИМАТЕЛЬНО ПРОЧИТАТЕ И СОХРАНИТЕ!













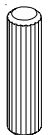

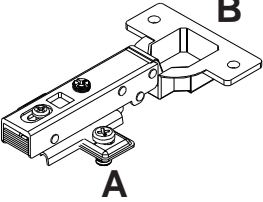

72003-03.19.

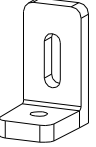
Service

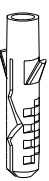

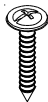
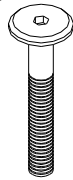
@ info@roba-kids.com
www.roba-kids.com

Bei Rückfragen zu diesem Artikel bitte die folgende Kenn-Nummer und Art.-Nr. angeben:
If you have any questions concerning this article use this identification number
and item number:

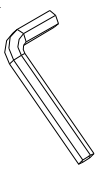
1311792 - HU

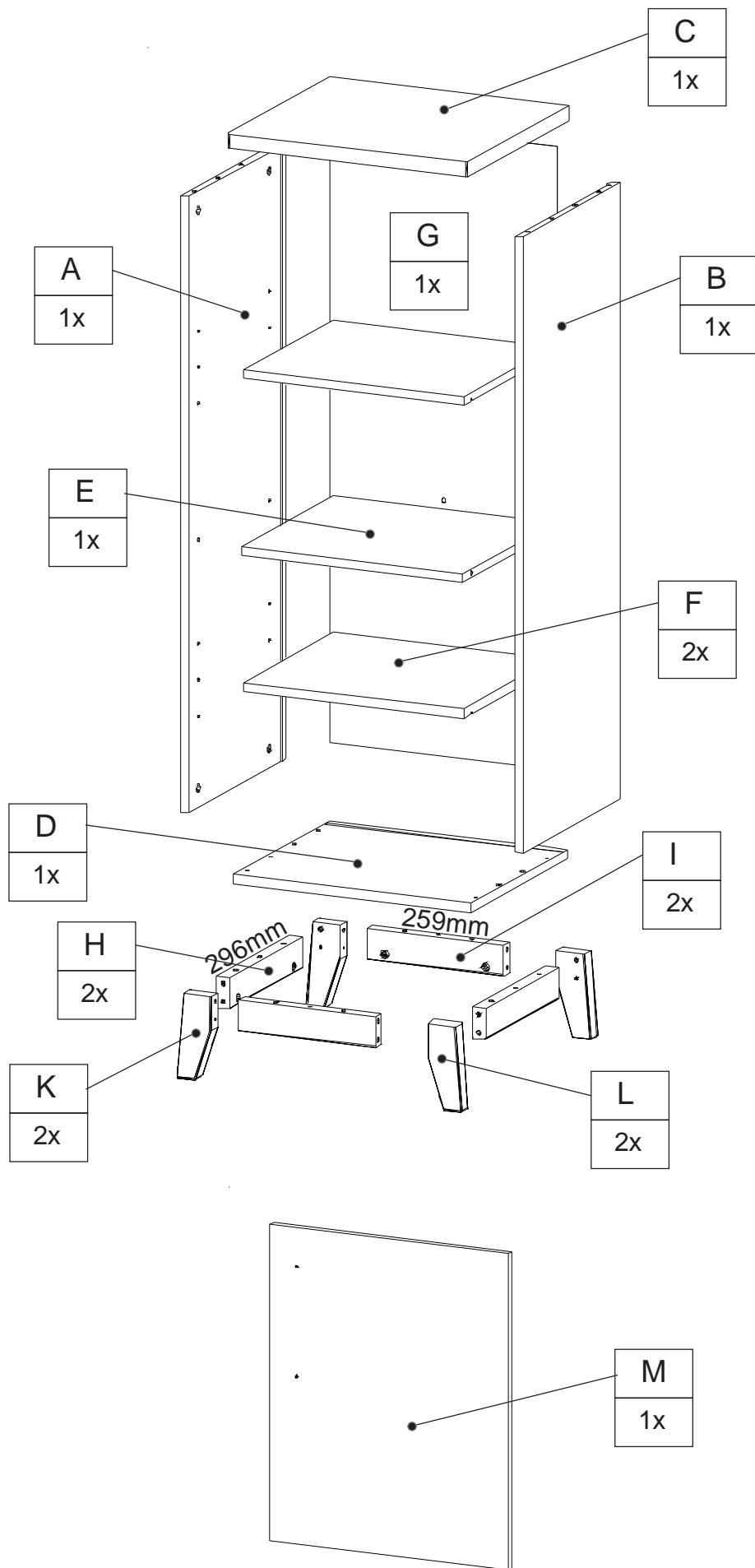

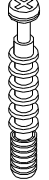

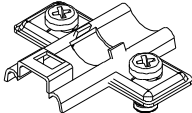
O02	O04	E02	E06	M07		A06		F03	Q04
20x	4x	20x	20x	1x		2x		4x	1x
									
ø8/30mm	ø8/60mm	ø15/12mm						3,5x16mm	
G09	O07	F41	L11	F18	Z21	W05	T01	C42	G12
1x	1x	1x	12x	3x	4x	6x	8x	1x	2x
									
4x17mm		4x70mm		3x20mm	M6x55mm				M4x30mm
W07									
1x									
									
4mm									

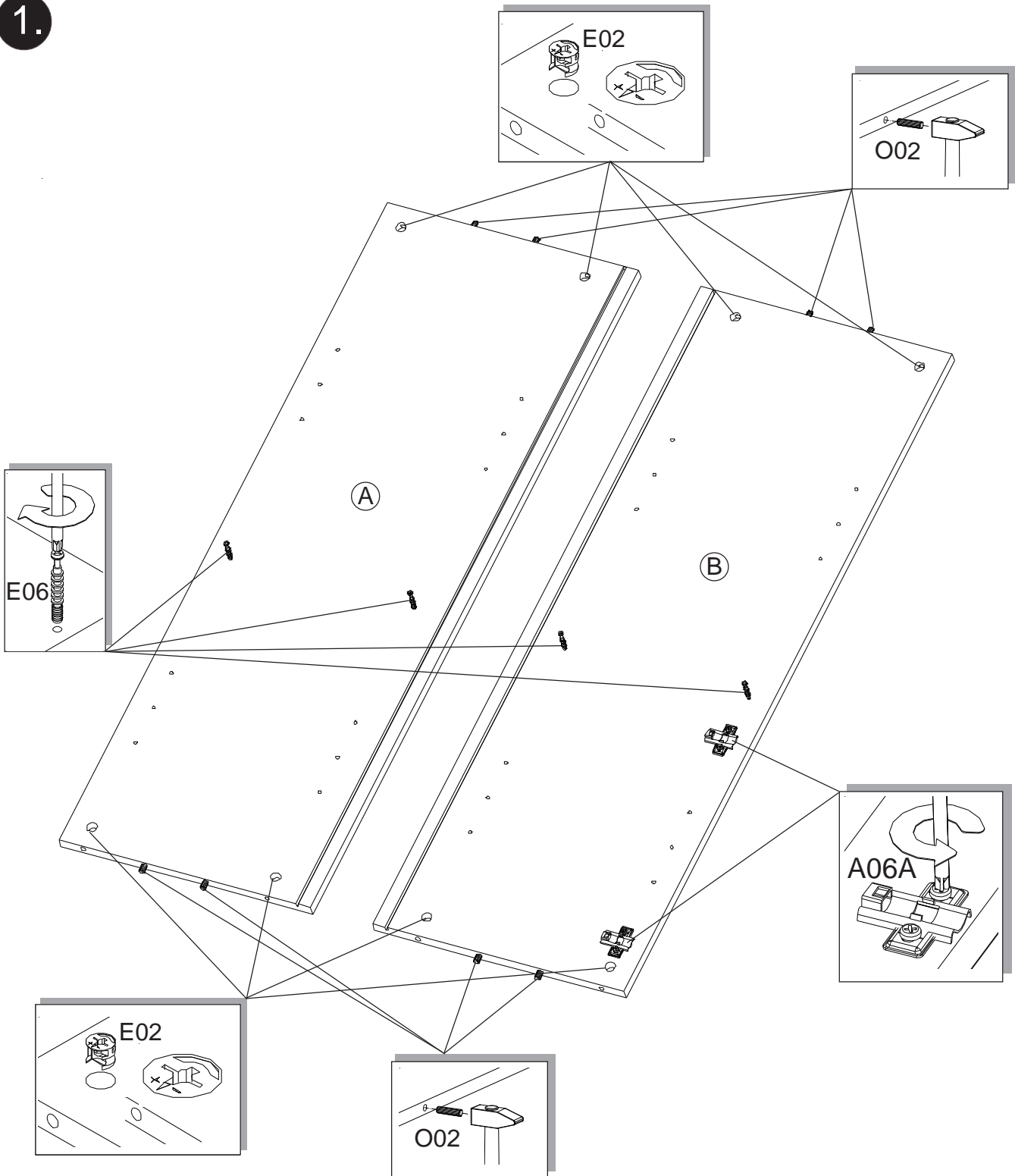

O02	E06	E02	A06A
			
8x	4x	8x	2x



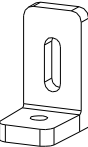

1.

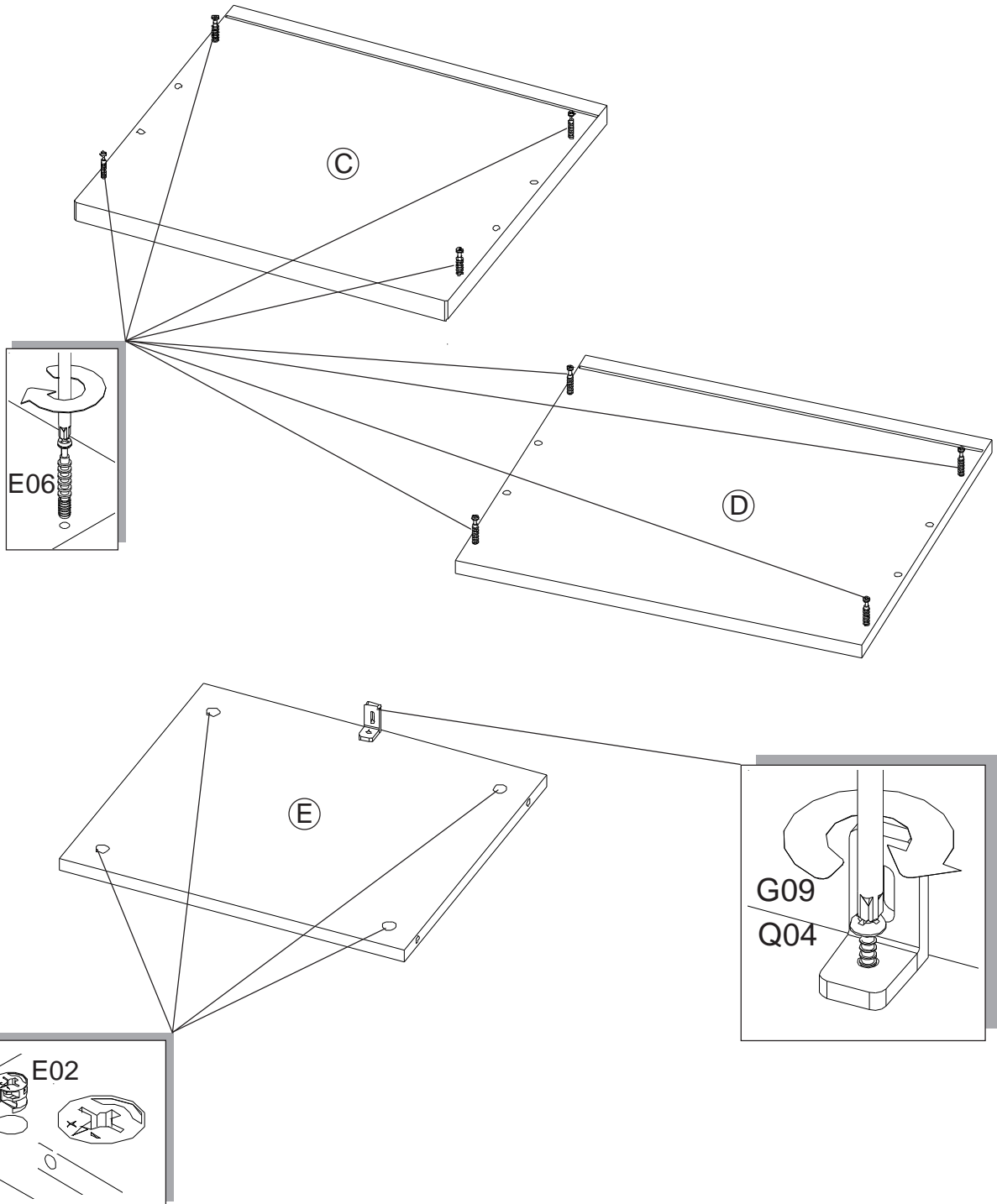

E02	E06	Q04	G09
			
4x	8x	1x	1x

2.



O02	O04	E06	E02
			
12x	4x	8x	8x

3.

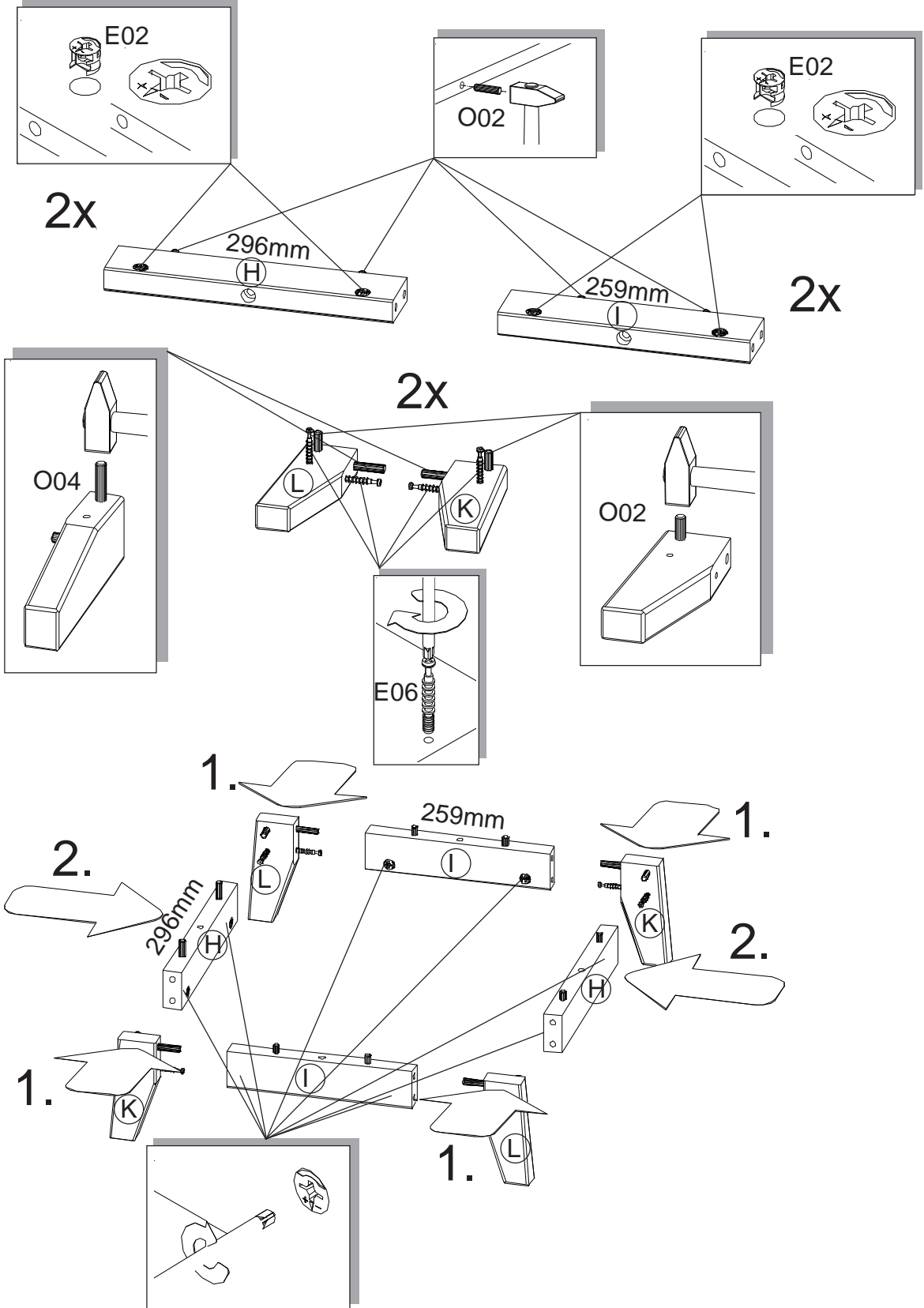



M07

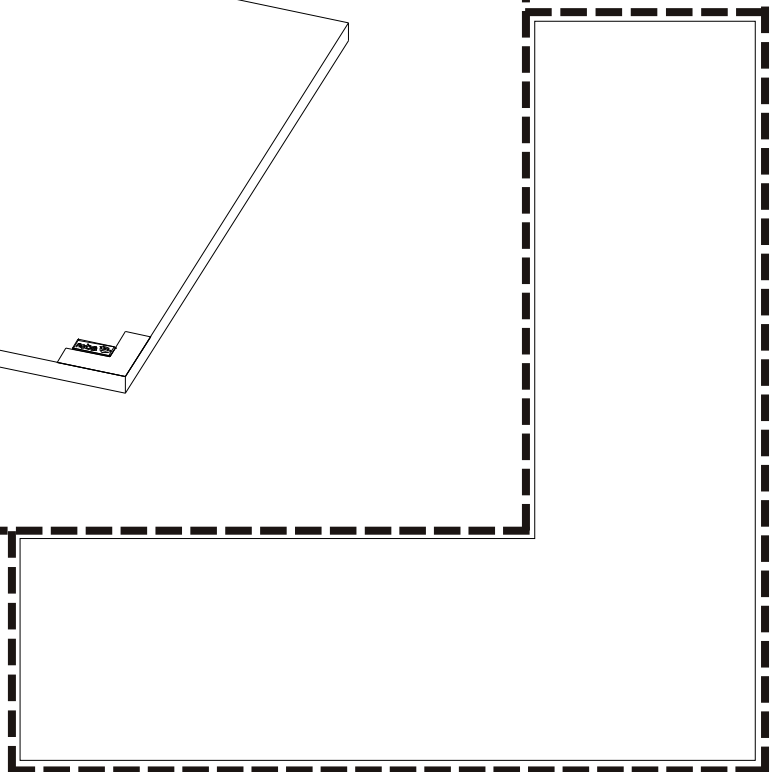
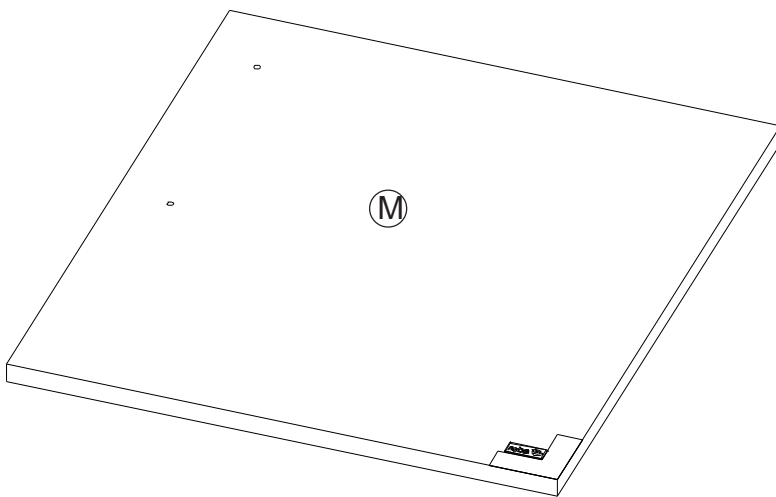
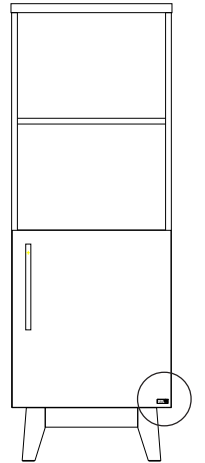
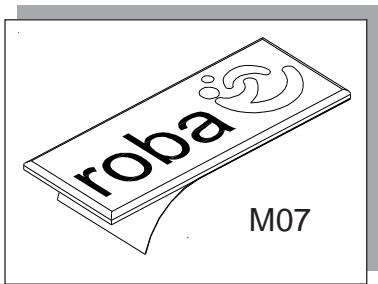

1x

4.

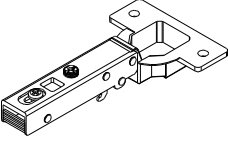

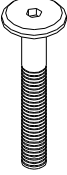
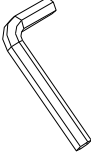
A06B	F03	Z21	W07
			
2x	4x	4x	1x

5.

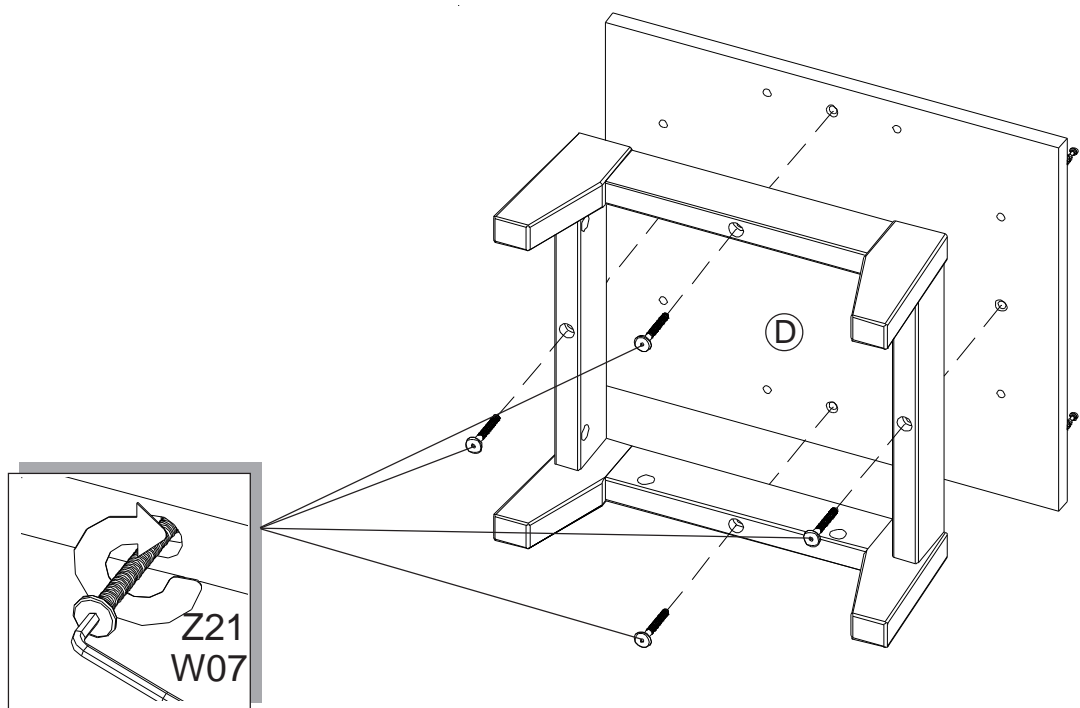
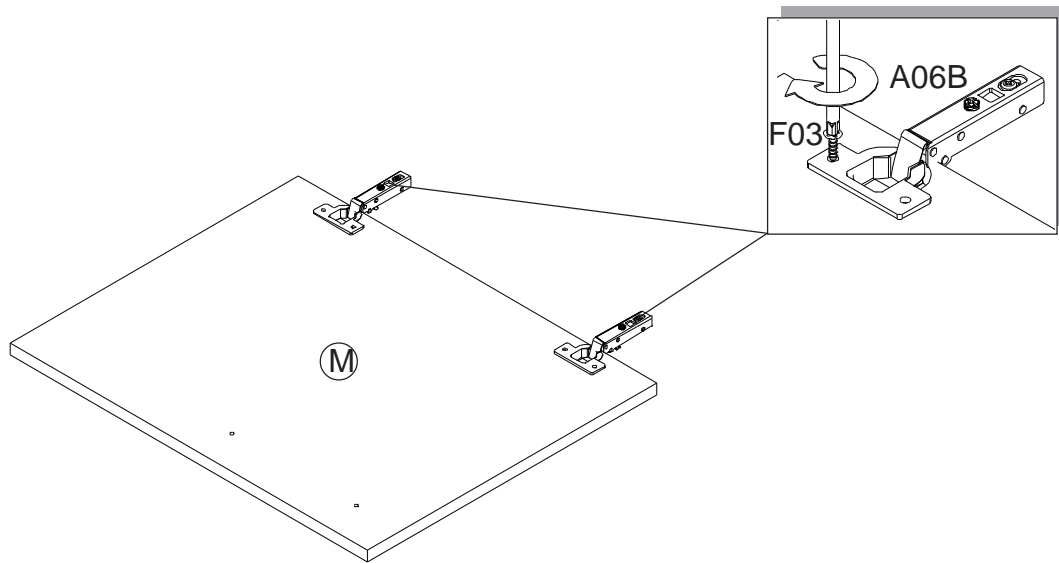

L11



8x

6.

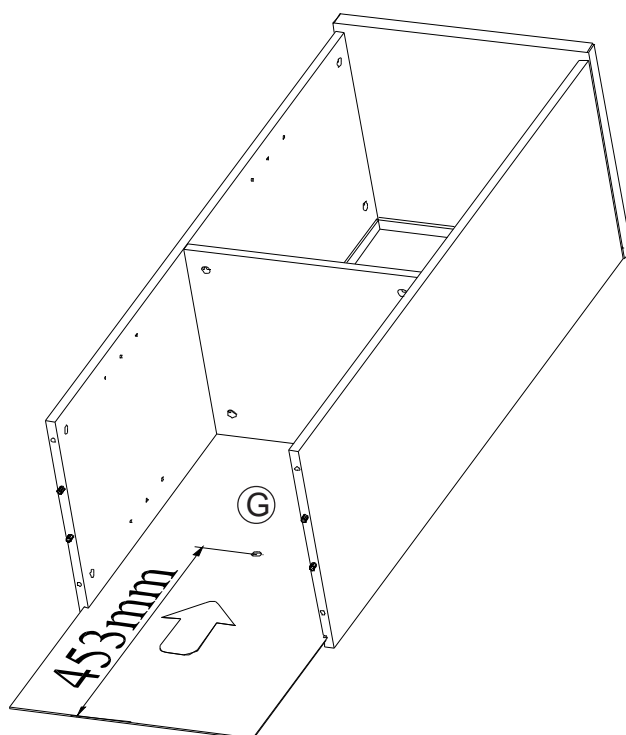
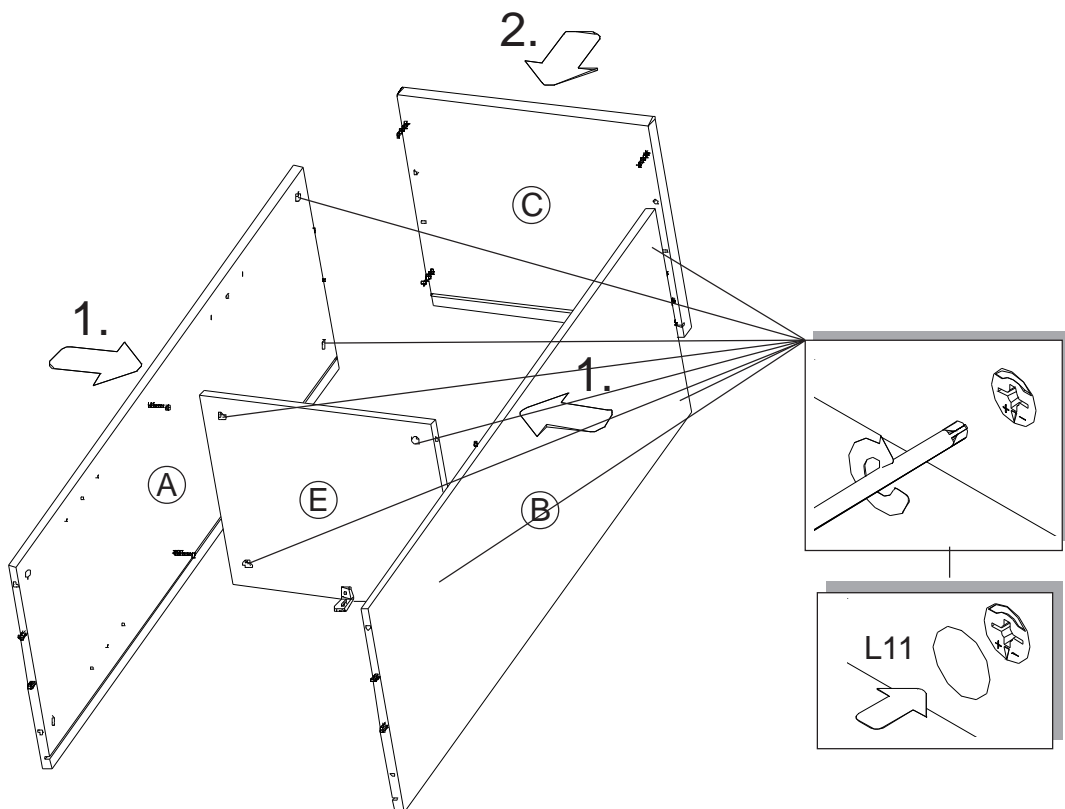

L11



4x

7.

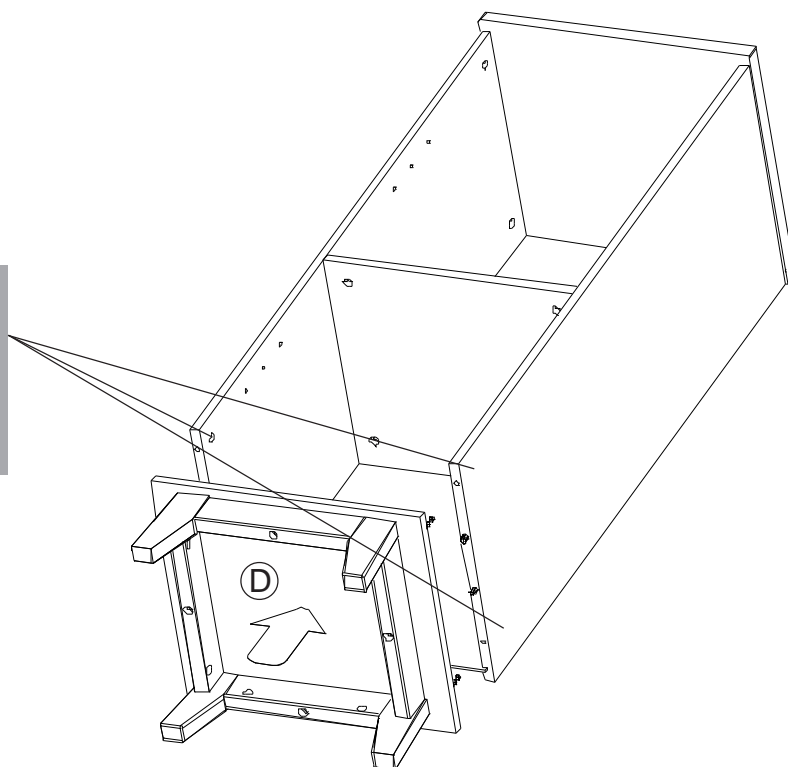
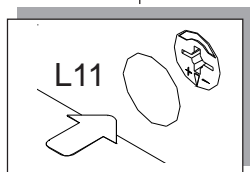
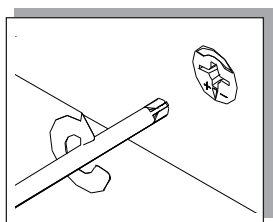

$x \text{ mm} = y \text{ mm} \quad 90^\circ$

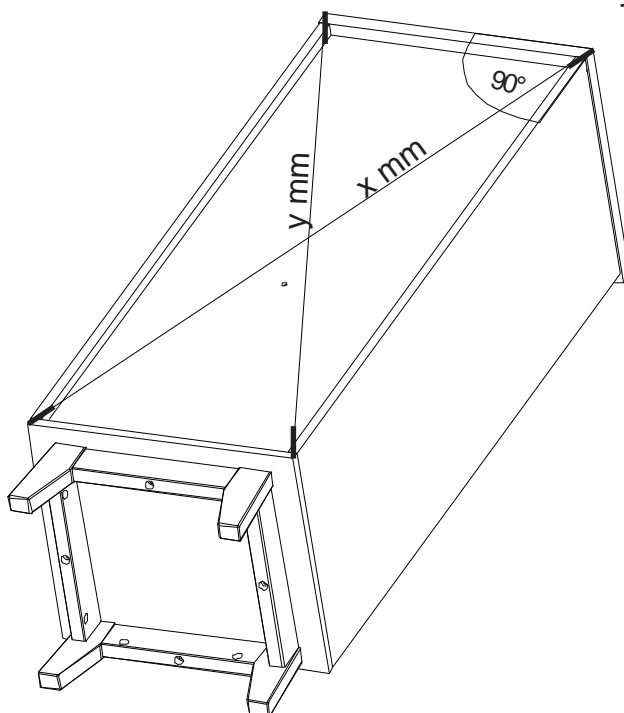

F18

W05

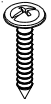

3x

6x

8.

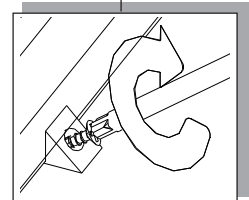
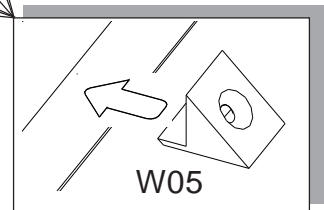
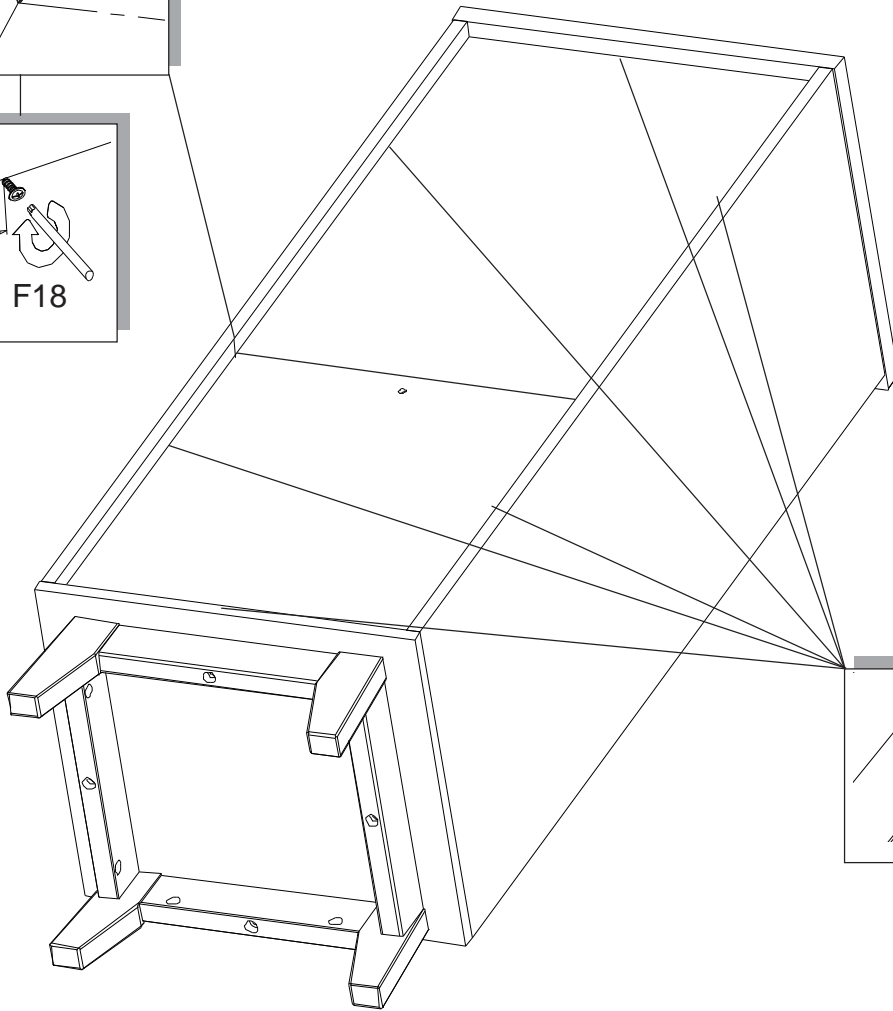
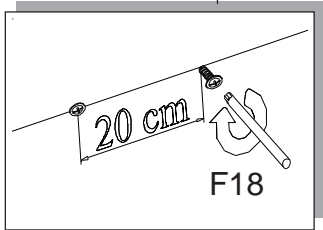
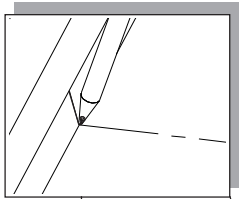

T01	C42	G12
		
8x	1x	2x

9.

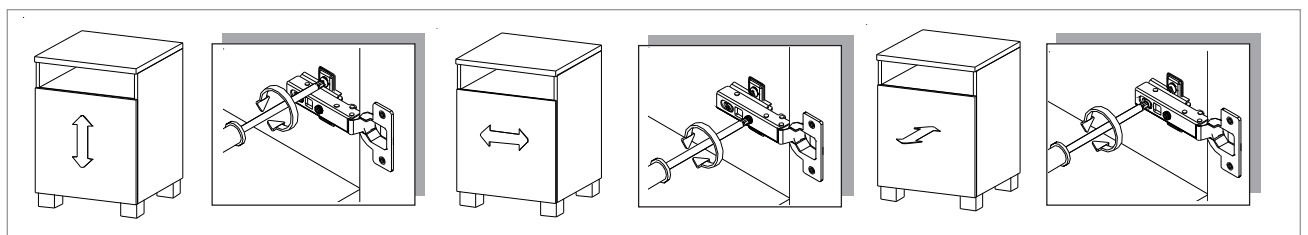
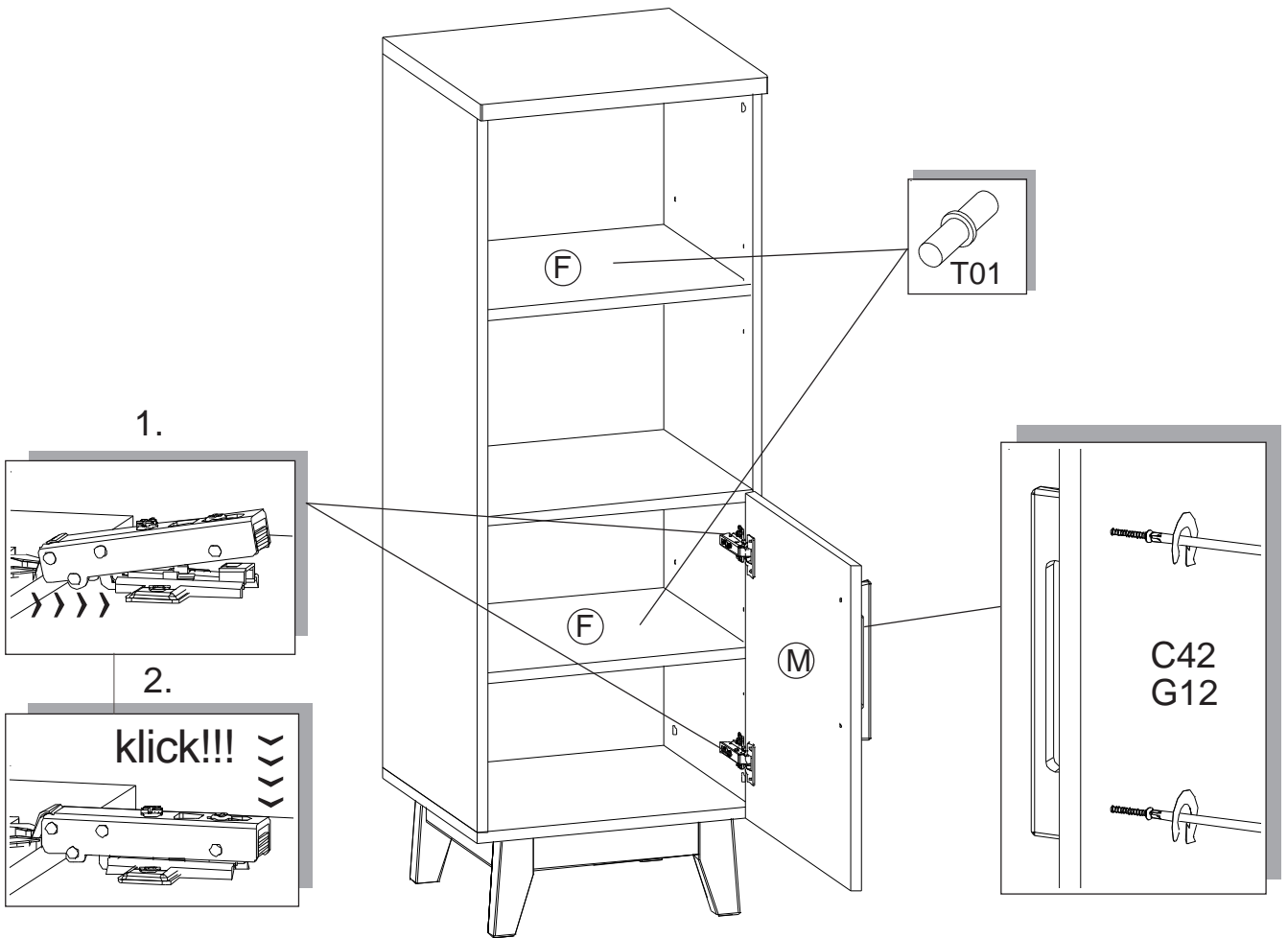

O07

F41

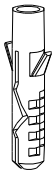

1x

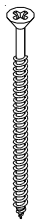

1x

10

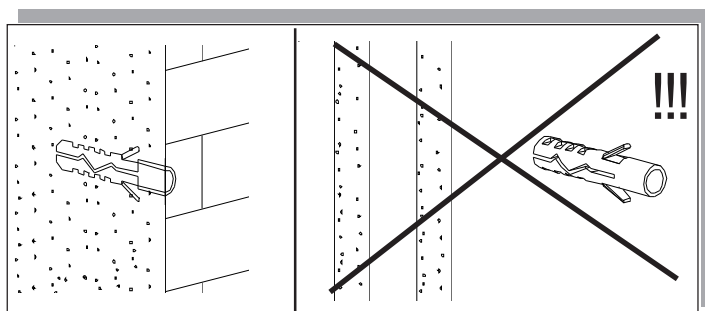
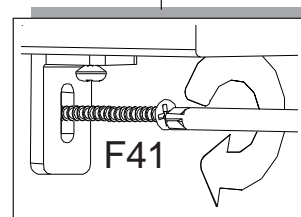
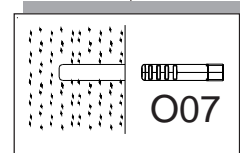
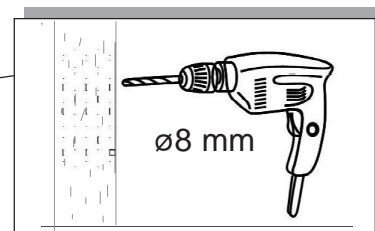
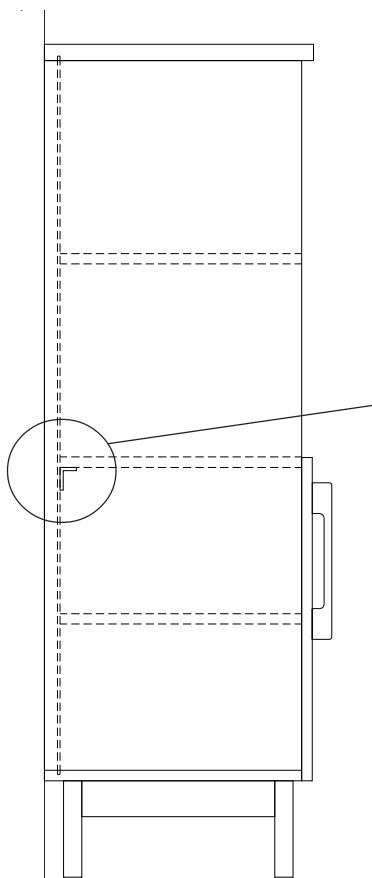

DE Sicherheitshinweise

- Verwenden Sie zum Reinigen der Oberflächen nur ein leicht feuchtes Tuch. Keinesfalls scheuernde oder ätzende Mittel bzw. harte Reinigungsbürsten etc. verwenden.
- **Achtung:** Das beiliegende Wandbefestigungsmaterial ist nur für Massivwände geeignet, bei anderen Wänden müssen Spezialdübel verwendet werden! Vor dem Bohren den Verlauf von Strom- und Wasserleitungen unbedingt überprüfen und berücksichtigen!

UK Notes on safety

- Clean the surfaces only with a slightly damp cloth. Never use abrasive or corrosive substances or hard cleaning brushes etc.
- **Attention!** The furniture must be attached to the wall for safety reasons and to increase its stability. The wall attached material only suitable for solid walls. Special wallpugs must be used for other walls! Check for electric power and water lines before drilling!

FR Consignes de sécurité

- N'utiliser qu'un chiffon légèrement humide pour nettoyer les surfaces. N'utiliser en aucun cas des produits récurants ou corrosifs ou des brosses dures etc.
- **Attention!** Pour des raisons de sécurité et afin d'augmenter la stabilité, le meuble doit être fixé au mur. Le matériel de fixation murale joint n'est adapté qu'aux murs pleins, pour les autres types de murs, des chevilles spéciales doivent être utilisées! Avant de percer, vérifiez et prenez en compte le tracé des câbles électriques et des conduites d'eau!

ES Instrucciones de seguridad

- Use para limpiar las superficies únicamente un paño ligeramente humedecido. No use nunca medios abrasivos o agresivos ni cepillos de limpieza duros, etc.
- **Atención:** El material incluido para la sujeción mural sólo es adecuado para paredes macizas; para otras paredes deben utilizarse tacos especiales. Antes de taladrar es imprescindible comprobar y tener en cuenta el recorrido de los cables eléctricos y las tuberías de agua.

PT Instruções de segurança

- Para limpar as superfícies, utilize somente um pano ligeiramente húmido. Nunca utilize produtos abrasivos ou corrosivos, nem escovas de limpeza de pêlos duros.
- **Atenção:** O material fornecido para fixação à parede destina-se apenas a paredes maciças. Para outro tipo de parede é necessário utilizar buchas especiais! Antes de furar a parede, assegure-se que não passam canos de água ou cabos eléctricos no local onde pretende furar!

IT Informazioni di sicurezza

- Pulire le superfici con un panno leggermente inumidito. Non usare mai mezzi abrasivi o corrosivi oppure spazzole dure eccetera.
- **Avvertenza:** Il materiale di fissaggio incluso è adatto solo per pareti massicce. Per altri tipi di pareti occorre utilizzare tasselli speciali! Prima di eseguire la perforazione, controllare il tracciato delle linee elettriche e delle condutture idriche per non danneggiarle!

NL Veiligheidsinstructies

- Gebruik uitsluitend een licht vochtige doek om de oppervlakken te reinigen. In geen geval schurende of bijtende middelen c.q. harde reinigingsborstels enz. gebruiken.
- **Let op!** Om veiligheidsredenen en om de stabiliteit te verhogen, moet het meubelstuk aan de muur worden bevestigd. Het daarvoor bijgevoegde bevestigingsmateriaal is uitsluitend voor massieve muren geschikt. Voor andere muren moeten speciale pluggen worden gebruikt! Alvorens te boren, dient het verloop van elektriciteits- en waterleidingen te worden gecontroleerd. Houd hier rekening mee!

DK Sikkerhedshenvisninger

- Anvend kun en let fugtet klud til rengøring af overfladerne. Anvend under ingen omstændigheder skurende eller ætsende rengøringsmidler eller hårde rengøringsbørster etc.
- **Vigtigt:** Det medfølgende materiale til vægfastgørelse er kun egnet til massive vægge. Ved alle andre vægge skal der anvendes specialdybler! Inden der foretages boring skal det ubetinget kontrolleres, hvor el- og vandledningerne er lagt, således at der kan tages hensyn til dette!

SE Säkerhetsinformation

- Använd endast en något fuktad duk för rengöring av ytor. Använd aldrig skurande eller frätande medel resp. hårda rengöringsborstar.
- **OBST!** Medföljande material för väggmontering är endast lämpligt för massiva väggar, för andra väggar krävs specialpluggar! Innan du borrar: kontrollera var el- och vattenledningar finns och undvik att borra i närheten av dem!

FI Turvaohjeet

- Käytä pintojen puhdistukseen vain kevyesti kostutettua liinaa. Älä missään tapauksessa käytä hankaavia tai syövyttäviä aineita tai kovia puhdistusharjoja jne.
- **Huomio:** Mukana tulevat seinäkiinnitysmateriaalit soveltuvat ainoastaan massiivisiin seinäin, kaikissa muissa seinätyypeissä on käytettävä erikoistulppia! Tarkasta ehdottomasti sähkö- ja vesilinjojen kulku ennen poraamista ja ota ne huomioon!

NO Sikkerhetsanvisninger

- Benytt for rengjøring av overflatene bare en lett fuktig klut. Bruk under ingen omstendighet skurende eller etsende midler hhv. harde rengjøringsbørster etc.
- **GI akt:** Veggfeste materialet som følger med er kun egnet for massive vegger, på andre vegger må det bli brukt spesialplugger! Før man begynner med boringen, kontroller og ta hensyn til hvor strøm- og vannledningene går!

PL Wskazówki bezpieczeństwa

- Do czyszczenia powierzchni używaj delikatnie zwilżonej ściereczki. Nie wolno stosować środków o działaniu szorującym lub żrącym ani też szcetek itp.
- **Uwaga:** Dołączony materiał do mocowania nadaje się tylko do ścian masywnych, w przypadku innych ścian należy stosować specjalne kołki rozporowe! Przed wierceniem sprawdzić koniecznie przebieg przewodów elektrycznych i wodociągowych!

CZ Bezpečnostní pokyny

- K čištění povrchu používejte vždy pouze lehce navlhčený hadřík. V žádném případě nepoužívejte abrazivní či leptající prostředky nebo tvrdé čisticí kartáče apod.
- **Upozornění:** Příložený materiál pro připevnění ke zdi je vhodný pouze pro masivní zdi, u jiných typech zdí je třeba použít speciální hmoždinky! Než začnete vrtat, nezapomeňte v každém případě zkontrolovat, zda těmito místy neprochází elektrická vedení a vodovodní potrubí, a tuto skutečnost zohledněte při vrtání!

HU Biztonsági előírások

- A felületek tisztítására csak enyhén nedves ruhát használjon! Semmiképp ne használjon súroló vagy maró szekeret, ill. kemény tisztítókeféket, stb.!
- **Figyelem!** A mellékelt fal szerelőanyagok csak tömör falakon használhatók; egyéb falak esetén speciális tipliket kell alkalmazni! Fúrás előtt meg kell vizsgálni, hogy a fúrás helyén futnak-e áram- és vízvezetékek! Ha igen, azokat figyelembe kell venni!

HR Sigurnosne upute

- Za čišćenje površina koristite samo lagano navlaženu krpu. Nikako ne koristite sredstva koja grebu ili nagrizaaju, odn. krute četke za čišćenje itd.
- **Pozor!** Priloženi pričvršni materijal za pričvršćenje na zid prikladan je samo za masivne zidove, kod drugih vrsta zidova moraju da se koriste specijalni tiplovi! Prije bušenja obavezno provjeriti i uzeti u obzir tijek vodova za truju i vodu!

RO Indicații de securitate

- Utilizați pentru curățarea suprafețelor doar o cârpă ușor umezită. Sub nicio formă nu utilizați agenți abrazivi sau caustici, respectiv perii dure de curățare etc.
- **Atenție:** Materialul atașat pentru fixare în perete este adecvat numai pentru pereți masivi; în cazul altor pereți trebuie utilizate dibluri speciale! Înainte de găurire, verificați neapărat și aveți în vedere traseul conductorilor electrici și al conductelor de apă!

RS Sigurnosne upute

- Koristite za čišćenje površina samo lagano mokru krpu. Ni u kome slučaju koristite abraziona ili korozivna sredstva odnosno jake četke za čišćenje.
- **Pažnja:** Priloženi materijal za pričvršćivanje na zid pogodan je samo za masivne zidove, kod drugih vrsta zidova moraju da se koriste specijalni tiplovi! Pre bušenja, obavezno proverite i vodite računa o trasama električnih i vodovodnih vodova!

SK Bezpečnostné upozornenia

- Na čistenie povrchov používajte iba jemne navlhčenú utierku. V žiadnom prípade nepoužívajte práškové alebo žieravé čistiace prostriedky, príp. kefy na čistenie a p
- **Pozor:** Priložený materiál pre pripavenie na stenu je vhodný iba pre masívne steny. V prípade iných stien je potrebné použiť špeciálne hmoždinky! Pred začatím vrtania bezpečnostne skontrolujte a dbajte na umiestnenie elektrických vedení a vodovodných potrubí!

SI Varnostna navodila

- Za čiščenje površin uporabljajte le rahlo navlaženo krpo. V nobenem primeru ne smete uporabljati abrazivnih ali jedkih sredstev oz. trdih ščetk za čiščenje ipd.
- **Pozor:** Priložen material za pritrditev na steno je primeren le za masivne stene, pri vseh ostalih stenah je treba uporabiti poseben čep! Pred vrtanjem obvezno preverite, kje tečejo vodovodni in električni vodi ter se jim izognite!

TR Güvenlik uyarıları

- Yüzeylerin temizliği için sadece hafifçe nemlendirilmiş bir bez kullanınız. Kesinlikle çizici veya aşındırıcı maddeler ya da sert temizlik fırçaları v.s. kullanmayınız.
- **Dikkat:** Ekte bulunan ve duvara sabitlemeye yarayan malzeme sadece masif duvarlar için uygundur, diğer duvarlarda ise özel dübellerin kullanılması gerekir. Delme işleminden önce mutlaka elektrik ve su borularının nereden geçtiği kontrol edilmeli ve bu bilgi dikkate alınmalıdır.

GR Υποδείξεις ασφαλείας

- Ια τον καθαρισμό της βερνικωμένης επιφάνειας χρησιμοποιείτε μόνο ένα ελαφρώς βρεγμένο πανί. Μη χρησιμοποιείτε σε καμία περίπτωση ουσίες τριψίματος ή καυστικές ουσίες, σκληρές βούρτσες καθαρισμού κ.ο.κ.
- **Προσοχή:** Το εσώκλειστο υλικό στερέωσης στον τοίχο είναι κατάλληλο μόνο για συμπαγείς τοίχους, σε περίπτωση άλλων τοίχων πρέπει να χρησιμοποιούνται ειδικά ούπα! Πριν τη διάτρηση του τοίχου να ελέγχετε και να λαμβάνετε οποιαδήποτε υπόψη σας τη διαδρομή των αγωγών ρεύματος και νερού!

RU Информация по технике безопасности

- Уборку поверхностей проводите только влажным полотенцем. Не используйте моющие или едкие чистящие средства, а также жесткие щетки и др.
- **Внимание:** крепежные детали, входящие в комплект поставки, подходят только для монолитных стен, для других используются специальные дюбели! Перед сверлением обязательно проверьте, не пролегают ли в данном месте линии проводки и водяные трубы!